

PROJECT REPORT

TO: ENVIRONMENTAL EVALUATION COMMITTEE

AGENDA DATE: April 15, 2021

FROM: PLANNING & DEVELOPMENT SERVICES DEPT. AGENDA TIME: 1:30 PM/No.2

PROJECT TYPE: Vestermark Wastewater System CUP#20-0015 SUPERVISOR DIST #4

LOCATION: 2496 E Highway 78, Brawley, CA

APN 039-120-027-000

PARCEL SIZE: 13.05

GENERAL PLAN (existing) Agriculture GENERAL PLAN (proposed) N/A

ZONE (existing) S-1 (Open Space) /C-2/PE Medium Commercial Pre Existing

ZONE (proposed) N/A

GENERAL PLAN FINDINGS CONSISTENT INCONSISTENT MAY BE/FINDINGS

PLANNING COMMISSION DECISION: HEARING DATE: _____

APPROVED DENIED OTHER

PLANNING DIRECTORS DECISION: HEARING DATE: _____

APPROVED DENIED OTHER

ENVIROMENTAL EVALUATION COMMITTEE DECISION: HEARING DATE: 04/15/2021

INITIAL STUDY: #20-0018

NEGATIVE DECLARATION MITIGATED NEG. DECLARATION EIR

DEPARTMENTAL REPORTS / APPROVALS:

PUBLIC WORKS	<input type="checkbox"/> NONE	<input checked="" type="checkbox"/> ATTACHED
AG	<input type="checkbox"/> NONE	<input checked="" type="checkbox"/> ATTACHED
APCD	<input type="checkbox"/> NONE	<input checked="" type="checkbox"/> ATTACHED
E.H.S.	<input checked="" type="checkbox"/> NONE	<input type="checkbox"/> ATTACHED
FIRE / OES	<input checked="" type="checkbox"/> NONE	<input type="checkbox"/> ATTACHED
OTHER		

(See Attached) IID Letter dated November 2, 2020

REQUESTED ACTION:

Imperial County Planning & Development Services

(Jim Minnick, Director)

801 MAIN ST., EL CENTRO, CA, 92243 442-265-1736

on: 2021/04/15 10:58:01 AM, user: PLS, ip: 10.10.10.10, file: C:\PS\DATA\PROJECT REPORT\...

EEC ORIGINAL PKG

- NEGATIVE DECLARATION**
 MITIGATED NEGATIVE DECLARATION

*Initial Study & Environmental Analysis
For:*

**Conditional Use Permit #20-0015/Initial Study #20-0028
Kyle Vestermark On-Site Wastewater Treatment System**



Prepared By:
Patricia Valenzuela, Planner IV

Prepared For:
COUNTY OF IMPERIAL
Planning & Development Services Department
801 Main Street
El Centro, CA 92243
(442) 265-4236
www.icpds.com

April 2021

EEC ORIGINAL PKG

TABLE OF CONTENTS

	<u>PAGE</u>
<u>SECTION 1</u>	
I. INTRODUCTION	1-1
<u>SECTION 2</u>	
II. ENVIRONMENTAL CHECKLIST	2-1
PROJECT SUMMARY	2-3
ENVIRONMENTAL ANALYSIS	2-4
I. AESTHETICS.....	2-8
II. AGRICULTURE AND FOREST RESOURCES.....	2-8
III. AIR QUALITY.....	2-9
IV. BIOLOGICAL RESOURCES.....	2-10
V. CULTURAL RESOURCES.....	2-11
VI. ENERGY.....	2-10
VII. GEOLOGY AND SOILS.....	2-12
VIII. GREENHOUSE GAS EMISSION.....	2-13
IX. HAZARDS AND HAZARDOUS MATERIALS.....	2-14
X. HYDROLOGY AND WATER QUALITY.....	2-15
XI. LAND USE AVIND PLANNING.....	2-17
XII. MINERAL RESOURCES.....	2-17
XIII. NOISE.....	2-18
XIV. POPULATION AND HOUSING.....	2-19
XV. PUBLIC SERVICES.....	2-19
XVI. RECREATION.....	2-20
XVII. TRANSPORTATION / TRAFFIC.....	2-20
XVIII. TRIBAL CULTURAL RESOURCES	2-20
X. UTILITIES AND SERVICE SYSTEMS.....	2-22
XX. WILDFIRES.....	2-22
<u>SECTION 3</u>	
III. MANDATORY FINDINGS OF SIGNIFICANCE	3-1
IV. PERSONS AND ORGANIZATIONS CONSULTED	3-2
V. REFERENCES	3-3
VI. NEGATIVE DECLARATION-COUNTY OF IMPERIAL	3-4
VII. FINDINGS	3-5
<u>SECTION 4</u>	
VIII. RESPONSE TO COMMENTS	4-1

SECTION 1

INTRODUCTION

A. PURPOSE

This document is a policy-level; project level Initial Study for evaluation of potential environmental impacts resulting with the proposed addition to the Dunes Edge RV Park (A" & "B"). For purposes of this document, the Conditional Use Permit will be called the "proposed applications".

B. CALIFORNIA ENVIRONMENTAL QUALITY ACT (CEQA) REQUIREMENTS AND THE IMPERIAL COUNTY'S "RULES AND REGULATIONS TO IMPLEMENT CEWA AS AMENDED"

As defined by Section 15063 of the State California Environmental Quality Act (CEQA) Guidelines and Section 7 of the County's Implementing CEQA, an **Initial Study** is prepared primarily to provide the Lead Agency with information to use as the basis for determining whether an Environmental Impact Report (EIR), Negative Declaration, or Mitigated Negative Declaration would be appropriate for providing the necessary environmental documentation and clearance for any proposed project.

According to Section 15065, an **EIR** is deemed appropriate for a particular proposal if the following conditions occur:

- The proposal has the potential to substantially degrade quality of the environment.
- The proposal has the potential to achieve short-term environmental goals to the disadvantage of long-term environmental goals.
- The proposal has possible environmental effects that are individually limited but cumulatively considerable.
- The proposal could cause direct or indirect adverse effects on human beings.

According to Section 15070(a), a **Negative Declaration** is deemed appropriate if the proposal would not result in any significant effect on the environment.

According to Section 15070(b), a **Mitigated Negative Declaration** is deemed appropriate if it is determined that though a proposal could result in a significant effect, mitigation measures are available to reduce these significant effects to insignificant levels.

This Initial Study has determined that the proposed applications will not result in any potentially significant environmental impacts and therefore, a Negative Declaration is deemed as the appropriate document to provide necessary environmental evaluations and clearance as identified hereinafter.

This Initial Study and Negative Declaration are prepared in conformance with the California Environmental Quality Act of 1970, as amended (Public Resources Code, Section 21000 et. seq.); Section 15070 of the State & County of Imperial's Guidelines for Implementation of the California Environmental Quality Act of 1970, as amended (California Code of Regulations, Title 14, Chapter 3, Section 15000, et. seq.); applicable requirements of the County of Imperial; and the regulations, requirements, and procedures of any other responsible public agency or an agency with jurisdiction by law.

Pursuant to the County of Imperial Implementing CEQA, depending on the project scope, the County of Imperial

Board of Supervisors, Planning Commission and/or Planning Director is designated the Lead Agency, in accordance with Section 15050 of the CEQA Guidelines. The Lead Agency is the public agency, which has the principal responsibility for approving the necessary environmental clearances and analyses for any project in the County.

C. INTENDED USES OF INITIAL STUDY AND NEGATIVE DECLARATION

This Initial Study and Negative Declaration are informational documents, which are intended to inform County of Imperial decision makers, other responsible or interested agencies, and the general public of potential environmental effects of the proposed applications. The environmental review process has been established to enable public agencies to evaluate environmental consequences and to examine and implement methods of eliminating or reducing any potentially adverse impacts. While CEQA requires that consideration be given to avoiding environmental damage, the Lead Agency and other responsible public agencies must balance adverse environmental effects against other public objectives, including economic and social goals.

The Initial Study and Negative Declaration, prepared for the project will be circulated for a period of 20 days public and agency review and comments. At the conclusion, if comments are received, the County Planning Department will prepare a document entitled "Responses to Comments" which will be forwarded to any commenting entity and be made part of the record within 10-days of any project consideration.

D. CONTENTS OF INITIAL STUDY & NEGATIVE DECLARATION

This Initial Study is organized to facilitate a basic understanding of the existing setting and environmental implications of the proposed applications.

SECTION 1

I. INTRODUCTION presents an introduction to the entire report. This section discusses the environmental process, scope of environmental review, and incorporation by reference documents.

SECTION 2

II. ENVIRONMENTAL CHECKLIST FORM contains the County's Environmental Checklist Form. The checklist form presents results of the environmental evaluation for the proposed applications and those issue areas that would have either a significant impact, potentially significant impact, or no impact.

PROJECT SUMMARY, LOCATION AND ENVIRONMENTAL SETTINGS describes the proposed project entitlements and required applications. A description of discretionary approvals and permits required for project implementation is also included. It also identifies the location of the project and a general description of the surrounding environmental settings.

ENVIRONMENTAL ANALYSIS evaluates each response provided in the environmental checklist form. Each response checked in the checklist form is discussed and supported with sufficient data and analysis as necessary. As appropriate, each response discussion describes and identifies specific impacts anticipated with project implementation.

SECTION 3

III. MANDATORY FINDINGS presents Mandatory Findings of Significance in accordance with Section 15065 of the CEQA Guidelines.

IV. PERSONS AND ORGANIZATIONS CONSULTED identifies those persons consulted and involved in

preparation of this Initial Study and Negative Declaration.

V. **REFERENCES** lists bibliographical materials used in preparation of this document.

VI. **NEGATIVE DECLARATION – COUNTY OF IMPERIAL**

VII. **FINDINGS**

SECTION 4

VIII. **RESPONSE TO COMMENTS (IF ANY)**

E. **SCOPE OF ENVIRONMENTAL ANALYSIS**

For evaluation of environmental impacts, each question from the Environmental Checklist Form is summarized and responses are provided according to the analysis undertaken as part of the Initial Study. Impacts and effects will be evaluated and quantified, when appropriate. To each question, there are four possible responses, including:

1. **No Impact:** A "No Impact" response is adequately supported if the impact simply does not apply to the proposed applications.
2. **Less Than Significant Impact:** The proposed applications will have the potential to impact the environment. These impacts, however, will be less than significant; no additional analysis is required.
3. **Less Than Significant With Mitigation Incorporated:** This applies where incorporation of mitigation measures has reduced an effect from "Potentially Significant Impact" to a "Less Than Significant Impact".
4. **Potentially Significant Impact:** The proposed applications could have impacts that are considered significant. Additional analyses and possibly an EIR could be required to identify mitigation measures that could reduce these impacts to less than significant levels.

F. **POLICY-LEVEL or PROJECT LEVEL ENVIRONMENTAL ANALYSIS**

This Initial Study and Negative Declaration will be conducted under a policy-level, project level analysis.

Regarding mitigation measures, it is not the intent of this document to "overlap" or restate conditions of approval that are commonly established for future known projects or the proposed applications. Additionally, those other standard requirements and regulations that any development must comply with, that are outside the County's jurisdiction, are also not considered mitigation measures and therefore, will not be identified in this document.

G. **TIERED DOCUMENTS AND INCORPORATION BY REFERENCE**

Information, findings, and conclusions contained in this document are based on incorporation by reference of tiered documentation, which are discussed in the following section.

1. Tiered Documents

As permitted in Section 15152(a) of the CEQA Guidelines, information and discussions from other documents can be included into this document. Tiering is defined as follows:

"Tiering refers to using the analysis of general matters contained in a broader EIR (such as the one prepared for a general plan or policy statement) with later EIRs and negative declarations on narrower projects; incorporating by reference the general discussions from the broader EIR; and concentrating the later EIR or negative declaration solely on the issues specific to the later project."

Tiering also allows this document to comply with Section 15152(b) of the CEQA Guidelines, which discourages redundant analyses, as follows:

"Agencies are encouraged to tier the environmental analyses which they prepare for separate but related projects including the general plans, zoning changes, and development projects. This approach can eliminate repetitive discussion of the same issues and focus the later EIR or negative declaration on the actual issues ripe for decision at each level of environmental review. Tiering is appropriate when the sequence of analysis is from an EIR prepared for a general plan, policy or program to an EIR or negative declaration for another plan, policy, or program of lesser scope, or to a site-specific EIR or negative declaration."

Further, Section 15152(d) of the CEQA Guidelines states:

"Where an EIR has been prepared and certified for a program, plan, policy, or ordinance consistent with the requirements of this section, any lead agency for a later project pursuant to or consistent with the program, plan, policy, or ordinance should limit the EIR or negative declaration on the later project to effects which:

(1) Were not examined as significant effects on the environment in the prior EIR; or

(2) Are susceptible to substantial reduction or avoidance by the choice of specific revisions in the project, by the imposition of conditions, or other means."

2. Incorporation By Reference

Incorporation by reference is a procedure for reducing the size of EIRs/MND and is most appropriate for including long, descriptive, or technical materials that provide general background information, but do not contribute directly to the specific analysis of the project itself. This procedure is particularly useful when an EIR or Negative Declaration relies on a broadly-drafted EIR for its evaluation of cumulative impacts of related projects (*Las Virgenes Homeowners Federation v. County of Los Angeles* [1986, 177 Ca.3d 300]). If an EIR or Negative Declaration relies on information from a supporting study that is available to the public, the EIR or Negative Declaration cannot be deemed unsupported by evidence or analysis (*San Francisco Ecology Center v. City and County of San Francisco* [1975, 48 Ca.3d 584, 595]). This document incorporates by reference appropriate information from the "Final Environmental Impact Report and Environmental Assessment for the "County of Imperial General Plan EIR" prepared by Brian F. Mooney Associates in 1993 and updates

When an EIR or Negative Declaration incorporates a document by reference, the incorporation must comply with Section 15150 of the CEQA Guidelines as follows:

- The incorporated document must be available to the public or be a matter of public record (CEQA Guidelines Section 15150[a]). The General Plan EIR and updates are available, along with this document, at the County of Imperial Planning & Development Services Department, 801 Main Street, El Centro, CA 92243 Ph. (760) 482-4236.
- This document must be available for inspection by the public at an office of the lead agency (CEQA Guidelines Section 15150[b]). These documents are available at the County of Imperial Planning & Development Services Department, 801 Main Street, El Centro, CA 92243 Ph. (760) 482-4236.

- These documents must summarize the portion of the document being incorporated by reference or briefly describe information that cannot be summarized. Furthermore, these documents must describe the relationship between the incorporated information and the analysis in the tiered documents (CEQA Guidelines Section 15150[c]). As discussed above, the tiered EIRs address the entire project site and provide background and inventory information and data which apply to the project site. Incorporated information and/or data will be cited in the appropriate sections.
- These documents must include the State identification number of the incorporated documents (CEQA Guidelines Section 15150[d]). The State Clearinghouse Number for the County of Imperial General Plan EIR is SCH #93011023.
- The material to be incorporated in this document will include general background information (CEQA Guidelines Section 15150[f]). This has been previously discussed in this document.

II. *Environmental Checklist*

1. **Project Title:** Kyle Vestermark Water Treatment Plant Conditional Use Permit #20-0015
2. **Lead Agency:** Imperial County Planning & Development Services Department
3. **Contact person and phone number:** Patricia Valenzuela, Planner IV, (442-2165-1749)
4. **Address:** 801 Main Street, El Centro CA, 92243
5. **E-mail:** patriciavalenzuela@co.imperial.ca.us
6. **Project location:** 2496 East Highway 78, Brawley, CA this area is located in Imperial County, approximately 6 miles from the City of Brawley and approximately 15 miles from Glamis.
7. **Project sponsor's name and address:** Kyle Vestermark, 70 Hollyleap, Aliso Viejo , CA 92656
8. **General Plan designation:** Agriculture
9. **Zoning:** – C-2/S-1 Medium Commercial/ Open Space-Recreational
10. **Description of project:** The proposed project is to install an onsite wastewater treatment system (OWTS) to treat the effluent from the RV dump-holding tank. This will eliminate all but two of the 28 pump outs that occurred in 2019, reducing the environmental impacts caused from the use of the semi-truck trips used to remove the effluent.

The OWTS will consist of the following components: 1) new primary 10,000-gallon holding tank. This tank will have an internal partition to facilitate the removal of primary solids; 2) The secondary existing 10,000 gallon holding tank will also have an internal partition for primary solids removal and will act as a "wide" spot in the line in the 2nd chamber of the tank during the week prior to the (5) know "HIGH RV DUMP" WEEKEND. This tank will gravity feed into the new 500 gallon Pump tank; 3) A new 500 gallon float operated pump tank will discharge the effluent from the Secondary 10,000 gallon holding tank to the Facultative Pond; 4) The Facultative pond will have a trickle filter, a pond divider to enhance the nitrification/de-nitrification process, a liner to eliminate any seepage, and greater than 12" of freeboard. It will have dimension of 30' wide x 78' long x five-6" deep and surface area of 2,340. The pond will have a total volume of 75,000 gallons per "Gloyna Method" calculation. The Facultative pond will gravity fee to a Constructed Wetlands (CW) pond.; 5) The CD pond will be a Free Water Surface (FWS) design, will be lined and will have a nitrogen filtration bed (NFB) It will have dimension of 15" wide x 50" long with a varying depth of 18" to 2" and a surface area of 750 feet. It will have aquatic plants, greater than 12' of freeboard and will gravity drain to a new Subsurface Wastewater Infiltration System (SWIS) leach field. 6) The SWIS will be constructed with high capacity infiltrator chambers in (3) rows lengths of 56'.

The Facultative pond is sufficient to accommodate a daily loading of 1,500 gpd. Sludge and solid waste from the facility will be periodically hauled away. Sludge and solid waste from the treatment facility will be periodically hauled away.
11. **Surrounding land uses and setting:** The wastewater Treatment Plant is bordered by highway 78 to the south, Green Road to the East, agricultural land to the north and west.
12. **Other public agencies whose approval is required** (e.g., permits, financing approval, or participation agreement.): Planning Commission
13. **Have California Native American tribes traditionally and culturally affiliated with the project area requested consultation pursuant to Public Resources Code section 21080.3.1? If so, is there a plan for consultation that includes, for example, the determination of significance of impacts to tribal cultural resources, procedures regarding confidentiality, etc.?** An AB52 letter was sent out to Quechan Indian Tribe for a 30 day consultation period for review and comment. No comments have been received at this time.

ENVIRONMENTAL FACTORS POTENTIALLY AFFECTED:

The environmental factors checked below would be potentially affected by this project, involving at least one impact that is a "Potentially Significant Impact" as indicated by the checklist on the following pages.

<input type="checkbox"/> Aesthetics	<input type="checkbox"/> Agriculture and Forestry Resources	<input type="checkbox"/> Air Quality
<input type="checkbox"/> Biological Resources	<input type="checkbox"/> Cultural Resources	<input type="checkbox"/> Energy
<input type="checkbox"/> Geology /Soils	<input type="checkbox"/> Greenhouse Gas Emissions	<input type="checkbox"/> Hazards & Hazardous Materials
<input type="checkbox"/> Hydrology / Water Quality	<input type="checkbox"/> Land Use / Planning	<input type="checkbox"/> Mineral Resources
<input type="checkbox"/> Noise	<input type="checkbox"/> Population / Housing	<input type="checkbox"/> Public Services
<input type="checkbox"/> Recreation	<input type="checkbox"/> Transportation	<input type="checkbox"/> Tribal Cultural Resources
<input type="checkbox"/> Utilities/Service Systems	<input type="checkbox"/> Wildfire	<input type="checkbox"/> Mandatory Findings of Significance

ENVIRONMENTAL EVALUATION COMMITTEE (EEC) DETERMINATION

After Review of the Initial Study, the Environmental Evaluation Committee has:

Found that the proposed project COULD NOT have a significant effect on the environment, and a NEGATIVE DECLARATION will be prepared.

Found that although the proposed project could have a significant effect on the environment, there will not be a significant effect in this case because revisions in the project have been made by or agreed to by the project proponent. A MITIGATED NEGATIVE DECLARATION will be prepared.

Found that the proposed project MAY have a significant effect on the environment, and an ENVIRONMENTAL IMPACT REPORT is required.

Found that the proposed project MAY have a "potentially significant impact" or "potentially significant unless mitigated" impact on the environment, but at least one effect 1) has been adequately analyzed in an earlier document pursuant (final) to applicable legal standards, and 2) has been addressed by mitigation measures based on the earlier analysis as described on attached sheets. An ENVIRONMENTAL IMPACT REPORT is required, but it must analyze only the effects that remain to be addressed.

Found that although the proposed project could have a significant effect on the environment, because all potentially significant effects (a) have been analyzed adequately in an earlier EIR or NEGATIVE DECLARATION pursuant to applicable standards, and (b) have been avoided or mitigated pursuant to that earlier EIR or NEGATIVE DECLARATION, including revisions or mitigation measures that are imposed upon the proposed project, nothing further is required.

CALIFORNIA DEPARTMENT OF FISH AND GAME DE MINIMIS IMPACT FINDING: Yes No

<u>EEC VOTES</u>	<u>YES</u>	<u>NO</u>	<u>ABSENT</u>
PUBLIC WORKS	<input checked="" type="checkbox"/>	<input type="checkbox"/>	<input type="checkbox"/>
ENVIRONMENTAL HEALTH	<input checked="" type="checkbox"/>	<input type="checkbox"/>	<input type="checkbox"/>
OFFICE EMERGENCY SERVICES	<input checked="" type="checkbox"/>	<input type="checkbox"/>	<input type="checkbox"/>
APCD	<input checked="" type="checkbox"/>	<input type="checkbox"/>	<input type="checkbox"/>
AG	<input checked="" type="checkbox"/>	<input type="checkbox"/>	<input type="checkbox"/>
SHERIFF DEPARTMENT	<input checked="" type="checkbox"/>	<input type="checkbox"/>	<input type="checkbox"/>
ICPDS	<input checked="" type="checkbox"/>	<input type="checkbox"/>	<input type="checkbox"/>

James Minnick, Director of Planning/EEC Chairman

4-21-2024
Date:

PROJECT SUMMARY

- A. Project Location:** The project is located at 2496 E. Highway 78, Brawley, CA and more specifically described as APN 039-120-027-000 (refer to Exhibit "A"), approximately 13 acres and further described as Section 33, township 13 South, Range 16 East, SBBM, Brawley, CA.
- B. Project Summary:** The proposed project is to install an onsite wastewater treatment system (OWTS) to treat the effluent from the RV dump-holding tank. This will eliminate all but two of the 28 pump outs that occurred in 2019, reducing the environmental impacts caused from the use of the semi-truck trips used to remove the effluent.

The OWTS will consist of the following components: 1) new primary 10,000-gallon holding tank. This tank will have an internal partition to facilitate the removal of primary solids; 2) The secondary existing 10,000 gallon holding tank will also have an internal partition for primary solids removal and will act as a "wide" spot in the line in the 2nd chamber of the tank during the week prior to the (5) know "HIGH RV DUMP" WEEKEND. This tank will gravity feed into the new 500 gallon Pump tank; 3) A new 500 gallon float operated pump tank will discharge the effluent from the Secondary 10,000 gallon holding tank to the Facultative Pond; 4) The Facultative pond will have a trickle filter, a pond divider to enhance the nitrification/de-nitrification process, a liner to eliminate any seepage, and greater than 12" of freeboard. It will have dimension of 30' wide x 78' long x five-6" deep and surface area of 2,340. The pond will have a total volume of 75,000 gallons per "Gloyna Method" calculation. The Facultative pond will gravity fee to a Constructed Wetlands (CW) pond.; 5) The CD pond will be a Free Water Surface (FWS) design, will be lined and will have a nitrogen filtration bed (NFB) It will have dimension of 15" wide x 50" long with a varying depth of 18" to 2" and a surface area of 750 feet. It will have aquatic plants, greater than 12' of freeboard and will gravity drain to a new Subsurface Wastewater Infiltration System (SWIS) leach field. 6) The SWIS will be constructed with high capacity infiltrator chambers in (3) rows lengths of 56'.

The Facultative pond is sufficient to accommodate a daily loading of 1,500 gpd, sludge and solid waste from the facility will be periodically hauled away.

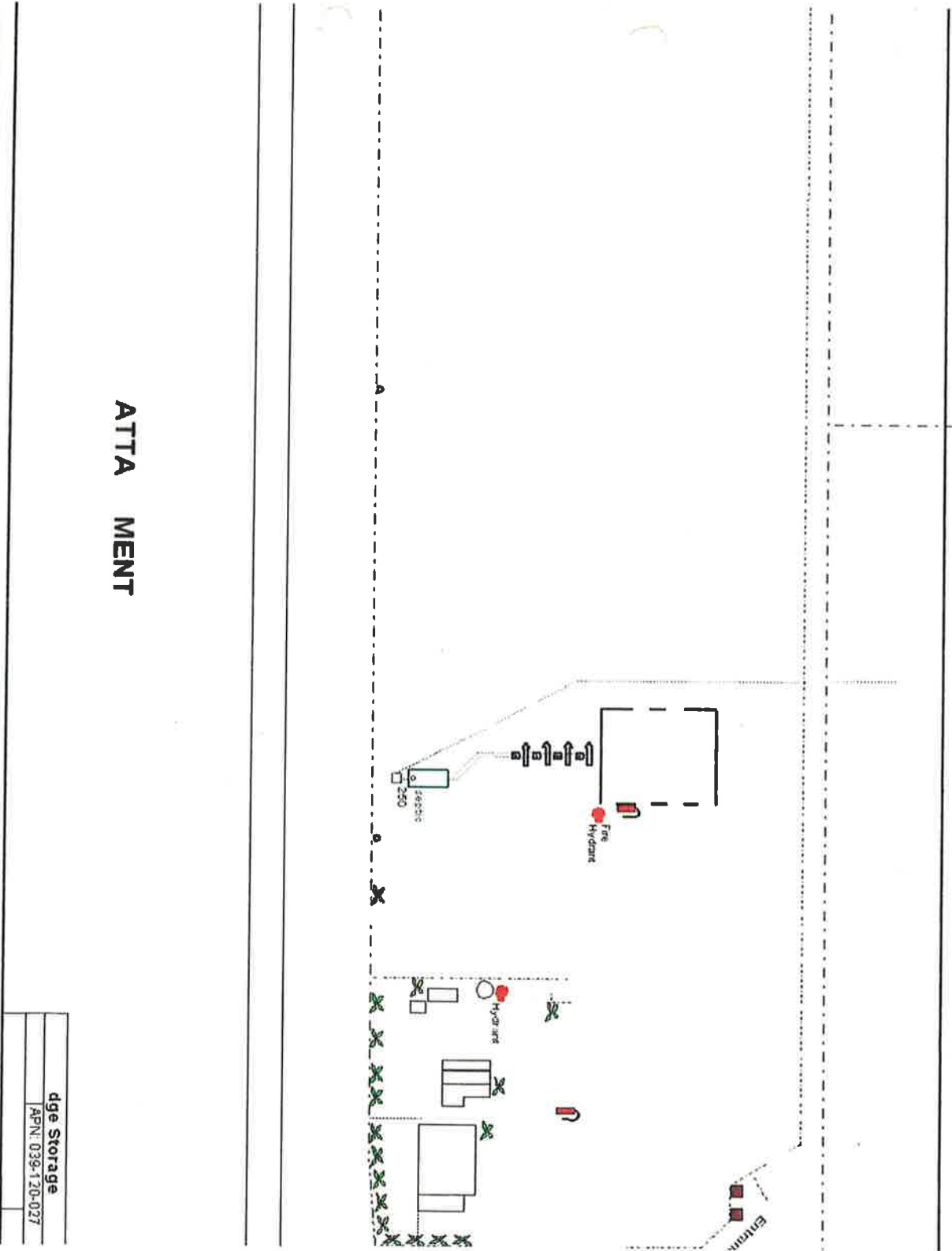
- C. Environmental Setting:** The proposed project site is located within the existing Dunes Edge RV Storage. The Water Treatment Plant is bordered by Green Road on the East, Highway 78 on the south and agricultural land to the north and west.
- D. Analysis:** Under the Land Use Element of the Imperial County General Plan, the project site is designated as "Agriculture". It is classified as "C-2 PE (Medium Commercial, Pre-Existing)" under the Imperial County Land Use Ordinance (Title 9).
- E. General Plan Consistency:** The proposed project is to expand the Dunes Edge Waste Water Plant, pursuant to the Land Use Element of the Imperial County General Plan, Goal 8, Objective 8.7; to... "Ensure the development, improvement, timing and location of community sewer, water, and drainage facilities will meet the needs of existing community"... and therefore could be found consistent with the intent the General Plan with an approved Conditional Use Permit.

Exhibit "A"
Vicinity Map

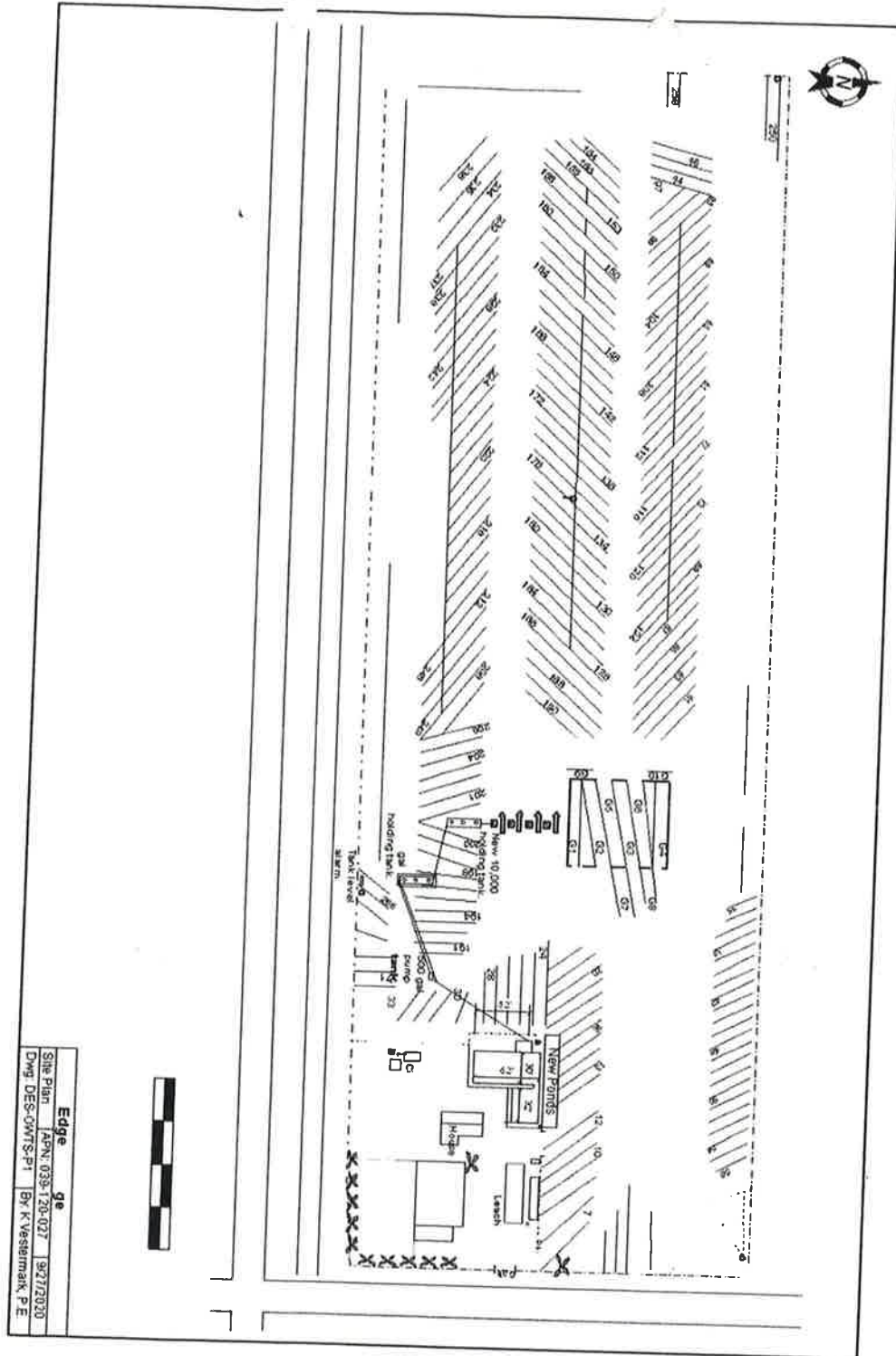


Exhibit "B"
Site Plan.

ATT A
MENT



dge Storage
APN: 039-120-027



EVALUATION OF ENVIRONMENTAL IMPACTS:

- 1) A brief explanation is required for all answers except "No Impact" answers that are adequately supported by the information sources a lead agency cites in the parentheses following each question. A "No Impact" answer is adequately supported if the referenced information sources show that the impact simply does not apply to projects like the one involved (e.g., the project falls outside a fault rupture zone). A "No Impact" answer should be explained where it is based on project-specific factors as well as general standards (e.g., the project will not expose sensitive receptors to pollutants, based on a project-specific screening analysis).
- 2) All answers must take account of the whole action involved, including off-site as well as on-site, cumulative as well as project-level, indirect as well as direct, and construction as well as operational impacts.
- 3) Once the lead agency has determined that a particular physical impact may occur, then the checklist answers must indicate whether the impact is potentially significant, less than significant with mitigation, or less than significant. "Potentially Significant Impact" is appropriate if there is substantial evidence that an effect may be significant. If there are one or more "Potentially Significant Impact" entries when the determination is made, an EIR is required.
- 4) "Negative Declaration: Less Than Significant With Mitigation Incorporated" applies where the incorporation of mitigation measures has reduced an effect from "Potentially Significant Impact" to a "Less Than Significant Impact." The lead agency must describe the mitigation measures, and briefly explain how they reduce the effect to a less than significant level (mitigation measures from "Earlier Analyses," as described in (5) below, may be cross-referenced).
- 5) Earlier analyses may be used where, pursuant to the tiering, program EIR, or other CEQA process, an effect has been adequately analyzed in an earlier EIR or negative declaration. Section 15063(c)(3)(D). In this case, a brief discussion should identify the following:
 - a) Earlier Analysis Used. Identify and state where they are available for review.
 - b) Impacts Adequately Addressed. Identify which effects from the above checklist were within the scope of and adequately analyzed in an earlier document pursuant to applicable legal standards, and state whether such effects were addressed by mitigation measures based on the earlier analysis.
 - c) Mitigation Measures. For effects that are "Less than Significant with Mitigation Measures Incorporated," describe the mitigation measures which were incorporated or refined from the earlier document and the extent to which they address site-specific conditions for the project.
- 6) Lead agencies are encouraged to incorporate into the checklist references to information sources for potential impacts (e.g., general plans, zoning ordinances). Reference to a previously prepared or outside document should, where appropriate, include a reference to the page or pages where the statement is substantiated.
- 7) Supporting Information Sources: A source list should be attached, and other sources used or individuals contacted should be cited in the discussion.
- 8) This is only a suggested form, and lead agencies are free to use different formats; however, lead agencies should normally address the questions from this checklist that are relevant to a project's environmental effects in whatever format is selected.
- 9) The explanation of each issue should identify:
 - a) the significance criteria or threshold, if any, used to evaluate each question; and
 - b) the mitigation measure identified, if any, to reduce the impact to less than significance

	Potentially Significant Impact (PSI)	Potentially Significant Unless Mitigation Incorporated (PSUMI)	Less Than Significant Impact (LTSI)	No Impact (NI)
--	--------------------------------------	--	-------------------------------------	----------------

I. AESTHETICS

Would the project:

- a) Have a substantial adverse effect on a scenic vista or scenic highway?

The proposed project is not located within a scenic vista or scenic highway pursuant to the Circulation and Scenic Element of the Imperial County General Plan. Therefore, no impacts are expected.

- b) Substantially damage scenic resources, including, but limited to, trees, rock outcroppings, and historic buildings within a state scenic highway?

The proposed project (expansion of existing water treatment facility) will occur within the existing RV facility site. The proposed modification will not damage scenic resources including tress, outcropping, and historical buildings within a state scenic highway. Therefore, no impacts are expected.

- c) Substantially degrade the existing visual character or quality of the site and its surroundings?

The proposed project (on site wastewater treatment system) includes upgrading the existing facility. All proposed work will occur on existing facility site and will not degrade the existing visual character. Therefore, no impacts are expected.

- d) Create a new source of substantial light or glare which would adversely affect day or nighttime views in the area?

The proposed project does not intend to install new lighting. Therefore, no impacts from Lighting should occur.

II. AGRICULTURE AND FOREST RESOURCES

In determining whether impacts to agricultural resources are significant environmental effects, lead agencies may refer to the California Agricultural Land Evaluation and Site Assessment Model (1997) prepared by the California Department of Conservation as an optional model to use in assessing impacts on agriculture and farmland. In determining whether impacts to forest resources, including timberland, are significant environmental effects, lead agencies may refer to information compiled by the California Department of Forestry and Fire Protection regarding the state's inventory of forest land, including the Forest and Range Assessment Project and the Forest Legacy Assessment project; and forest carbon measurement methodology provided in Forest Protocols adopted by the California Air Resources Board. --Would the project:

- a) Convert Prime Farmland, Unique Farmland, or Farmland of Statewide Importance (Farmland), as shown on the maps prepared pursuant to the Farmland Mapping and Monitoring Program of the California Resources Agency, to non-agricultural use?

The proposed project lies within the existing RV storage facility boundary and will not convert Prime Farmland, Unique Farmland, or Farmland of Statewide Importance (Farmland) as shown on the Imperial County Important Farmland 2008 Map. Therefore, no impacts are expected.

	Potentially Significant Impact (PSI)	Potentially Significant Unless Mitigation Incorporated (PSUMI)	Less Than Significant Impact (LTSI)	No Impact (NI)
b) Conflict with existing zoning for agricultural use, or a Williamson Act contract?	<input type="checkbox"/>	<input type="checkbox"/>	<input type="checkbox"/>	<input checked="" type="checkbox"/>

The proposed project site is not under a Williamson Act Contract; therefore will not conflict with existing zoning for agricultural use nor conflict with a Williamson Act contract. Therefore, no impacts are expected.

c) Conflict with existing zoning for, or cause rezoning of, forest land (as defined in Public Resources Code section 12220(g)), timberland (as defined by Public Resources Code section 4526), or timberland zoned Timberland Production (as defined by Government Code section 51104(g))?	<input type="checkbox"/>	<input type="checkbox"/>	<input type="checkbox"/>	<input checked="" type="checkbox"/>
--	--------------------------	--------------------------	--------------------------	-------------------------------------

The proposed project lies with the existing RV facility boundary and will not convert Prime Farmland, Unique Farmland, or Farmland of Statewide Importance (Farmland) as shown on the Imperial County Important Farmland 2008 Map. Therefore, no impacts are expected.

d) Result in the loss of forest land or conversion of forest land to non-forest use?	<input type="checkbox"/>	<input type="checkbox"/>	<input type="checkbox"/>	<input checked="" type="checkbox"/>
--	--------------------------	--------------------------	--------------------------	-------------------------------------

The proposed project lies within an existing RV facility boundary and will not result in the loss of forest land or conversion of forest land to non-forest land. Therefore, no impact expected.

e) Involve other changes in the existing environment which, due to their location or nature, could result in conversion of Farmland, to non-agricultural use or conversion of forest land to non-forest use?	<input type="checkbox"/>	<input type="checkbox"/>	<input type="checkbox"/>	<input checked="" type="checkbox"/>
--	--------------------------	--------------------------	--------------------------	-------------------------------------

The proposed project is an onsite wastewater treatment system; and this addition will not modify the existing environment which due to their location or nature, nor result in the conversion of Farmland to non-agricultural use or conversion of forest land to non-forest use. Therefore, no impacts are expected.

III. AIR QUALITY

Where available, the significance criteria established by the applicable air quality management or air pollution control district may be relied upon to the following determinations. Would the Project:

a) Conflict with or obstruct implementation of the applicable air quality plan?	<input type="checkbox"/>	<input type="checkbox"/>	<input checked="" type="checkbox"/>	<input type="checkbox"/>
---	--------------------------	--------------------------	-------------------------------------	--------------------------

The proposed project will treat the effluent from the RV dump holding tank and will not obstruct implementation of any applicable air quality plan. However, the project would be required to conform to the requirements of the Imperial County Air Pollution Control District (Regulation 800 (fugitive dust) and Rule 310 (Operational Development Fee if applicable)). Accordingly, there would be a less than significant impact. Therefore, any impacts would be less than significant.

b) Violate any air quality standard or contribute substantially to an existing or projected air quality violation?	<input type="checkbox"/>	<input type="checkbox"/>	<input checked="" type="checkbox"/>	<input type="checkbox"/>
--	--------------------------	--------------------------	-------------------------------------	--------------------------

The proposed project does not appear to violate any air quality or contribute substantially to an existing or projected air quality violation. However, during the construction of the on site wastewater treatment system there will be an increase in earth moving activity. Per Imperial County Air Pollution Control District comment letter dated, November 4, 2020, the applicant shall be required to comply with the requirements of Regulation VIII, Fugitive Dust Control Regulations, which should reduce any impacts to less than significant.

	Potentially Significant Impact (PSI)	Potentially Significant Unless Mitigation Incorporated (PSUMI)	Less Than Significant Impact (LTSI)	No Impact (NI)
--	--------------------------------------	--	-------------------------------------	----------------

Therefore, any impacts should be less than significant.

- c) Result in a cumulatively considerable net increase of any criteria pollutant for which the project region is non-attainment under an applicable federal or state ambient air quality standard (including releasing emissions which exceed quantitative thresholds for ozone precursors)?
-

The proposed improvements to be installed will result in temporary emissions during construction and may increase criteria pollutants; however, the implementation of ICAPCD Regulation VIII will bring any potential impacts to less than significant. Additionally, the applicant shall comply with the California Air Resources Board (CARB) certification standards for off-road diesel engines, utilizing statewide registration or Air District permit per ICAPCD comment letter, dated November 4, 2020 and April 1, 2021.

- d) Expose sensitive receptors to substantial pollutants concentrations?
-

The proposed project may expose receptors to pollutants during construction, but as stated above, the implementation of ICAPCD Regulation VII will bring any potential impacts to less than significant.

- e) Create objectionable odors affecting a substantial number of people?
-

The proposed project may create objectionable odors during temporary construction, which will consist of the installment of an on-site wastewater treatment system to treat the effluent from the RV dump-holding tank. The applicant will be subject to all requirements and stipulation enforced by the Imperial County Air Pollution Control District (APCD). Construction and operation of the project site will be subject to the requirements as stated in the ICAPCD comment letter dated November 4, 2020 and April 1, 2021 which will bring potential impacts to less than significant. Therefore, any impacts are less than significant.

IV. BIOLOGICAL RESOURCES

Would the project:

- a) Have a substantial adverse effect, either directly or through habitat modifications, on any species identified as a candidate, sensitive, or special status species in local or regional plans, policies, or regulations, or by the California Department of Fish and Game or U.S. Fish and Wildlife Service?
-

The proposed project site is located within disturbed land and does not appear to effect, either directly or through habitat modification, any species identified as a candidate, sensitive, or special status species in local or regional plan, policies, or regulation, or by the California Department of Fish and Wildlife or U.S. Fish and Wildlife Services; therefore, no impact is expected.

- b) Have a substantial adverse effect on any riparian habitat or other sensitive natural community identified in local or regional plans, policies, regulations, or by the California Department of Fish and Game or U.S. Fish and Wildlife Service?
-

As mentioned above, the project site is located within previously disturbed land and does not appear to have an effect on any riparian habitat or other sensitive natural community identified

	Potentially Significant Impact (PSI)	Potentially Significant Unless Mitigation Incorporated (PSUMI)	Less Than Significant Impact (LTSI)	No Impact (NI)
--	--------------------------------------	--	-------------------------------------	----------------

in local or regional plan, policies, and regulation or by the California Department of Fish and Wildlife or U.S. Fish and Wildlife Services. Therefore, no impacts are expected.

- c) Have a substantial adverse effect on federally protected wetlands as defined by Section 404 of the Clean Water Act (including, but not limited to, marsh, vernal pool, coastal, etc.) through direct removal, filling, hydrological interruption, or other means?

The proposed project will not have an adverse effect on federal protected wetlands as defined by Section 404 of the Clean Water Act (including, but not limited to, marsh, vernal pool, coastal, etc.) through direct removal, filling, hydrological interruption, or other means. Therefore, no impacts are expected.

- d) Interfere substantially with the movement of any resident or migratory fish or wildlife species or with established native resident or migratory wildlife corridors, or impede the use of native wildlife nursery sites?

The proposed project lies within an existing RV Park wastewater treatment facility and will not interfere with the movement of any resident or migratory fish or wildlife species or with established resident or migratory wildlife corridors or impede the use of native wildlife nursery site. Therefore, no impact is expected.

- e) Conflict with any local policies or ordinances protecting biological resource, such as a tree preservation policy or ordinance?

The proposed project does not conflict with any local policy or ordinance protecting biological resources, such as a tree preservation policy or ordinance. Therefore, no impact is expected.

- f) Conflict with the provisions of an adopted Habitat Conservation Plan, Natural Community Conservation Plan, or other approved local, regional, or state habitat conservation plan?

The proposed project does not appear to conflict with any provision of an adopted Habitat Conservation Plan, Natural Community Conservation Plan or other approved local, regional, or state habitat conservation plan. Therefore, no impacts expected.

V. CULTURAL RESOURCES

Would the project:

- a) Cause a substantial adverse change in the significance of a historical resource as defined in §15064.5?

The proposed project is the production of treated water and not an increase to the footprint of the existing project site. Therefore, the proposed additions to the RV Park will not cause an adverse change in the significance of a historical resource as defined in §15064.5. The Sensitive Map for Cultural Resources, in the Conservation Open Space Element of the Imperial County General Plan Figure# 2.3.3 the area where the proposed project is located as an area defined as "zero to rare" for containing cultural resources. Therefore, no impact is expected.

- b) Cause a substantial adverse change in the significance of an archaeological resource pursuant to §15064.5?

	Potentially Significant Impact (PSI)	Potentially Significant Unless Mitigation Incorporated (PSUMI)	Less Than Significant Impact (LTSI)	No Impact (NI)
--	--------------------------------------	--	-------------------------------------	----------------

The proposed project lays within disturbed land and will not cause a substantial adverse change in the significance of an archaeological resource pursuant to §15064.5. Therefore, no impact is expected.

- | | | | | |
|---|--------------------------|--------------------------|--------------------------|-------------------------------------|
| c) Directly or indirectly destroy a unique paleontological resource or site or unique geologic feature? | <input type="checkbox"/> | <input type="checkbox"/> | <input type="checkbox"/> | <input checked="" type="checkbox"/> |
|---|--------------------------|--------------------------|--------------------------|-------------------------------------|

Again, as mentioned above, the on-site wastewater treatment system will not directly or indirectly destroy unique paleontological resource or site or unique geological feature. Therefore, no impact is expected.

- | | | | | |
|--|--------------------------|--------------------------|--------------------------|-------------------------------------|
| d) Disturb any human remains, including those interred outside of formal cemeteries? | <input type="checkbox"/> | <input type="checkbox"/> | <input type="checkbox"/> | <input checked="" type="checkbox"/> |
|--|--------------------------|--------------------------|--------------------------|-------------------------------------|

The proposed project an existing water treatment facility and does not foresee any disturbance of any human remains, including those interred outside of formal cemeteries. Therefore, no impact is expected.

VI. ENERGY *Would the project:*

- | | | | | |
|---|--------------------------|--------------------------|-------------------------------------|--------------------------|
| a) Result in potentially significant environmental impact due to wasteful, inefficient, or unnecessary consumption of energy resources, during project construction or operation? | <input type="checkbox"/> | <input type="checkbox"/> | <input checked="" type="checkbox"/> | <input type="checkbox"/> |
|---|--------------------------|--------------------------|-------------------------------------|--------------------------|

The wastewater from this project will rely on natural resources to dissolve; therefore, any impacts are considered less than significant.

- | | | | | |
|---|--------------------------|--------------------------|-------------------------------------|--------------------------|
| b) Conflict with or obstruct a state or local plan for renewable energy or energy efficiency? | <input type="checkbox"/> | <input type="checkbox"/> | <input checked="" type="checkbox"/> | <input type="checkbox"/> |
|---|--------------------------|--------------------------|-------------------------------------|--------------------------|

The proposed project includes the installation of a wastewater treatment system and it is not expected to have an impact, therefore any impacts should be less than significant.

VII. GEOLOGY AND SOILS

Would the project:

- | | | | | |
|--|--------------------------|--------------------------|-------------------------------------|--------------------------|
| a) Expose people or structures to potential substantial adverse effects, including risk of loss, injury, or death involving: | <input type="checkbox"/> | <input type="checkbox"/> | <input checked="" type="checkbox"/> | <input type="checkbox"/> |
|--|--------------------------|--------------------------|-------------------------------------|--------------------------|

According to the State of California Revised January 1, 1990 Special Studies Maps, the proposed project is not located in a "Special Studies area". Additionally, the proposed project is not located within a known earthquake fault as delineated on the most recent Alquist Priolo Earthquake Fault Zoning Map. However, the site would still be affected by the occurrence of seismic activity to some degree, but no more than the surrounding properties. Additionally, Imperial County is classified as a Seismic Classification 4 by the California Building Code, (Section 1626 through 1635), which requires development to incorporate the most stringent earthquake resistant measures. Therefore any impacts should be less than significant.

- | | | | | |
|--|--------------------------|--------------------------|--------------------------|-------------------------------------|
| 1) Rupture of a known earthquake fault, as delineated on the most recent Alquist-Priolo Earthquake Fault Zoning Map issued by the State Geologist for the area or based on other substantial evidence of a known fault? Refer to Division of Mines and Geology Special Publication 42? | <input type="checkbox"/> | <input type="checkbox"/> | <input type="checkbox"/> | <input checked="" type="checkbox"/> |
|--|--------------------------|--------------------------|--------------------------|-------------------------------------|

	Potentially Significant Impact (PSI)	Potentially Significant Unless Mitigation Incorporated (PSUMI)	Less Than Significant Impact (LTSI)	No Impact (NI)
--	--------------------------------------	--	-------------------------------------	----------------

As mentioned above, the project site is not located within a known earthquake fault as delineated on the most recent Alquist Priolo Earthquake Fault Zoning Map. Therefore, no impacts are expected.

- 2) Strong Seismic ground shaking?

As mentioned above, the proposed project site will be affected by the occurrence of seismic ground shaking, but no more than the surrounding properties. Therefore, the project impacts will be less than significant.

- 3) Seismic-related ground failure, including liquefaction and seiche/tsunami?

The proposed project site does not appear to be located on geological units or soil that is unstable or that would become unstable as a result of seismic activities, including liquefaction and seiche/tsunami; therefore, any impacts are considered less than significant.

- 4) Landslides?

The proposed project site lies within generally flat topography and therefore will not be directly or indirectly affected by a landslide; therefore, no impact is expected

- b) Result in substantial soil erosion or the loss of topsoil?

The proposed wastewater treatment system is minimal and should not result in the substantial loss of soil or minimal loss of top soil; therefore, no impact is expected.

- c) Be located on a geologic unit or soil that is unstable or that would become unstable as a result of the project, and potentially result in on- or off-site landslides, lateral spreading, subsidence, liquefaction or collapse?

The proposed project does not appear to be located on geological units or soil that is unstable or that would become unstable as a result of the project or potential in, on or off-site landslide, lateral spreading subsidence liquefaction or collapse. Therefore, no impact is expected.

- d) Be located on expansive soil, as defined in the latest Uniform Building Code, creating substantial risk to life or property?

The proposed project does not appear to be located on expansive soil as defined in the latest California Building Code, creating substantial risk to life or property. Therefore, no impacts are expected.

- e) Are soils incapable of adequately supporting the use of septic tanks or alternative waste water disposal systems where sewers are not available for the disposal of waste water?

The proposed project is the construction of an on-site wastewater treatment system to treat the waste from the RV septic and appears the system is capable of supporting septic tanks, or alternative water disposal system. Therefore, any impacts are expected to be less than significant.

VIII. GREENHOUSE GAS EMISSION

Would the project:

	Potentially Significant Impact (PSI)	Potentially Significant Unless Mitigation Incorporated (PSUMI)	Less Than Significant Impact (LTSI)	No Impact (NI)
--	--------------------------------------	--	-------------------------------------	----------------

- a) Generate greenhouse gas emissions, either directly or indirectly, that may have a significant impact on the environment?

The proposed project will create emissions during the construction period which primary source is diesel equipment. As such, a less than significant impact is expected. Accordingly, the applicant shall comply with all ICAPCD requirements for dust control and GHG emissions. Therefore, impacts are expected to be less than significant.

- b) Conflict with an applicable plan or policy or regulation adopted for the purpose of reducing the emissions of greenhouse gases?

The proposed project does not appear to conflict with any applicable plan or policy or regulation adopted for the purpose of reducing emission of greenhouse gases. Therefore, any impacts are expected to be less than significant.

IX. HAZARDS AND HAZARDOUS MATERIALS

Would the project:

- a) Create a significant hazard to the public or the environment through the routine transport, use, or disposal of hazardous materials?

The proposed project does not intend to transport, use, or dispose of hazardous waste. Therefore, any impacts should be less than significant.

- b) Create a significant hazard to the public or the environment through reasonable foreseeable upset and accident conditions involving the release of hazardous materials into the environment?

As stated above, the Applicant does not intend to transport, use, or dispose of hazardous waste. Therefore, any impacts are considered less than significant.

- c) Emit hazardous emissions or handle hazardous or acutely hazardous materials, substances, or waste within one-quarter mile of an existing or proposed school?

The proposed project is not located within one-quarter (1/4) mile of a school site, but as explained above, with the proper handling in accordance with applicable laws, the potential for a hazardous material incident will reduce impacts. Therefore, any impacts are considered less than significant.

- d) Be located on a site, which is included on a list of hazardous materials sites compiled pursuant to Government Code Section 65962.5 and, as a result, would it create a significant hazard to the public or the environment?

The proposed project is not located within or included on a list of hazardous material sites pursuant to Government Code, Section 65962.5, or result in creating a significant hazard to the public or environment. Therefore, no impact is expected.

	Potentially Significant Impact (PSI)	Potentially Significant Unless Mitigation Incorporated (PSUMI)	Less Than Significant Impact (LTSI)	No Impact (NI)
--	--------------------------------------	--	-------------------------------------	----------------

- e) For a project located within an airport land use plan or, where such a plan has not been adopted, within two miles of a public airport or public use airport, would the project result in a safety hazard for people residing or working in the project area?

The proposed project site is not located within an Airport Land Use Plan or within two miles of a public airport or public use airport, which would result within a safety hazard for people residing or working in the project area. Therefore, no impact is expected.

- f) For a project within the vicinity of a private airstrip, would the project result in a safety hazard for people residing or working in the project area?

The proposed project is not located within the vicinity of a private airstrip, which would result in a safety hazard for the people residing or working in the project area. Therefore, no project is expected.

- g) Impair implementation of or physically interfere with an adopted emergency response plan or emergency evacuation plan?

The proposed project does not propose to implement or physically interfere with an adopted emergency plan or emergency evacuation plan; therefore, no impact is expected.

- h) Expose people or structures to a significant risk of loss, injury or death involving wildland fires, including where wildlands are adjacent to urbanized areas or where residences are intermixed with wildlands?

The proposed project is the addition of a wastewater treatment facility and would not expose people or structures to a significant risk of loss, injury or death nor increase exposure to potential wild land fires, including where wild lands are adjacent to urbanized area or where residences are intermixed with wild lands. Therefore, no impacts are expected.

X. HYDROLOGY AND WATER QUALITY

Would the project:

- a) Create a significant hazard to the public or the environment through routine transport, use, or disposal of hazardous materials?

The proposed project will not store any chemicals on site; therefore, no impacts are expected.

- b) Substantially deplete groundwater supplies or interfere substantially with groundwater recharge such that there would be a net deficit in aquifer volume or a lowering of the local groundwater table level (e.g., the production rate of pre-existing nearby wells would drop to a level which would not support existing land uses or planned uses for which permits have been granted)?

The proposed project currently has a water source that provides to the applicant 250,000 to 300,000 gallons of water. They have had this amount since the conception of the RV Park and has not caused a deficit in the aquifer.

	Potentially Significant Impact (PSI)	Potentially Significant Unless Mitigation Incorporated (PSUMI)	Less Than Significant Impact (LTSI)	No Impact (NI)
--	--------------------------------------	--	-------------------------------------	----------------

Therefore, no impact is expected.

- c) Substantially alter the existing drainage pattern of the site or area, including through the alteration of the course of a stream or river, in a manner which would result in substantial erosion or siltation on- or off-site?

The proposed project does not propose to alter the existing drainage patterns of the site, and any grading and drainage concerns will be addressed by the Imperial County Public Works Department in the Grading and Drainage Plan. Therefore, the impact is considered less than significant.

- d) Substantially alter the existing drainage patterns of the site or area, including through the alteration of the course of a stream or river, or substantially increase the rate or amount of surface runoff in a manner which would result in flooding on- or off-site?

As explained above, the proposed project will not substantially alter the existing drainage patterns of the site, and all grading and drainage concerns will be addressed by Imperial County Public Works Department in the Grading and Drainage Plan. Therefore, any impacts are expected to be less than significant.

- e) Create or contribute runoff water, which would exceed the capacity of existing or planned stormwater drainage systems or provide substantial additional sources of polluted runoff?

The water utilized for the wastewater treatment system is raw water and although there will not be an increase in treated water; the process is constant. Additionally, as mentioned above, grading and drainage concerns will be addressed by Imperial County Public Works Department in the Grading and Drainage Plan. Therefore, any impacts should be considered less than significant.

- f) Otherwise substantially degrade water quality?

A storm water drainage system will be designated to accommodate runoff from the site during operation; however, as mentioned above, all grading and drainage concerns will be addressed by Imperial County Public Works Department in the Grading and Drainage Plan. Therefore, any impacts are considered less than significant.

- g) Place housing within a 100-year flood hazard area as mapped on a Flood Hazard Boundary or Flood Insurance Rate Map or other flood hazard delineation map?

The proposed project (onsite wastewater treatment facility) is located with Zone X per Federal Emergency Management Agency's (FEMA) Flood Insurance Rate Map (FIRM) Panel No. 06025C-1425C (effective September 26, 2008), and no housing project is being proposed. Therefore, no impact is expected.

- h) Place within a 100-year flood hazard area structures which would impede or redirect the flood flows?

As explained above, the proposed project site is located within Zone X and the proposed improvements do not appear to impede or redirect the flood flow. Therefore, no impact is expected.

- i) Expose people or structures to a significant risk of loss injury or death involving flooding, including flooding as a result of the failure of a levee or dam?

	Potentially Significant Impact (PSI)	Potentially Significant Unless Mitigation Incorporated (PSUMI)	Less Than Significant Impact (LTSI)	No Impact (NI)
--	--------------------------------------	--	-------------------------------------	----------------

The proposed project site is an existing RV Park and the addition of an on-site waste water facility will not ultimately change the existing use nor expose people or structure to a significant risk of loss, injury or death involving flooding, including flooding as a result of the failure of a levee or dam. Therefore, no impact is expected.

- j) Inundation by seiche, tsunami, or mudflow?

The existing topography of the project site is generally flat and there appears to be no significant chance of an inundation by tsunami, or mudflow or seiche. Therefore, no impact is expected.

XI. LAND USE AND PLANNING

Would the project:

- a) Physically divide an established community?

The proposed project is an expansion of an on-site wastewater treatment system to enhance the existing RV Park and does not physically divide any established community. Therefore, no impacts are expected.

- b) Conflict with any applicable land use plan, policy, or regulation of an agency with jurisdiction over the project (include, but not limited to the general plan, specific plan, local coastal program, or zoning ordinance) adopted for the purpose of avoiding or mitigating an environmental effect?

The proposed project does not conflict with any applicable land use plan, policy or regulation; therefore, no impact is expected.

- c) Conflict with any applicable habitat conservation plan or natural community conservation plan?

The proposed project does not conflict with any applicable habitat conservation plan or natural community conservation plan. Therefore, no impact is expected.

XII. MINERAL RESOURCES

Would the project:

- a) Result in the loss of availability of a known mineral resource that would be of value to the region and the residents of the state?

The proposed project does not affect the availability of a known material resource that would be of value to the region and the residents of the state; therefore, no impacts expected.

- b) Result in the loss of availability of a locally-important mineral resource recovery site delineated on a local general plan, specific plan or other land use plan?

The proposed project will not result in the loss of availability of a locally important mineral resource recovery site delineated in the local general plan, specific plan or other land use plan; therefore, no impact is expected.

	Potentially Significant Impact (PSI)	Potentially Significant Unless Mitigation Incorporated (PSUMI)	Less Than Significant Impact (LTSI)	No Impact (NI)
--	--------------------------------------	--	-------------------------------------	----------------

XIII. NOISE

Would the project result in:

- a) Exposure of persons to or generation of noise levels in excess of standards established in the local general plan or noise ordinance, or applicable standards of other agencies?

The proposed project will include some level of temporary noise exposure (i.e. equipment) during expansion of RV Park dump system), but those levels would be subject to the Construction Noise Standards, as set out in the Noise Element of the Imperial County General Plan (page 22), and would be short-term (during construction period). Therefore, impacts will be less than significant.

- b) Exposure of persons to or generation of excessive groundborne vibration or groundborne noise levels?

The proposed project will create minor exposure of ground vibration or noise level, but as stated above, those levels be subject to the Construction Noise Standards as set out Noise Element of the Imperial County General Plan (page 22), and would be short-term (during modification of facility). Therefore, impacts will be less than significant.

- c) A substantial permanent increase in ambient noise levels in the project vicinity above levels existing without the project?

The addition of the wastewater treatment system does not appear to create a substantial permanent increase of ambient noise levels in the project vicinity above levels existing without the project. Therefore, no noise is expected.

- d) A substantial temporary or periodic increase in ambient noise levels in the project vicinity above levels existing without the project?

The addition of the wastewater treatment system will result in temporary increases in noise levels in the immediate vicinity; however, these impacts will be intermittent, localized to the area of active construction, and will occur only during the duration of the construction. Therefore, impacts are considered less than significant.

- e) For a project located within an airport land use plan or where such a plan has not been adopted, within two miles of a public airport or public use airport, would the project expose people residing or working in the project area to excessive noise levels?

The proposed project is not located within an airport land use plan or two (2) miles of a public airport or public use airport. The nearest public airport according to the 1996 Imperial County Airport Compatibility Plan is Brawley Airport at approximately 6 miles east of the project site. Therefore, no impacts are expected.

- f) For a project within the vicinity of a private airstrip, would the project expose people residing or working in the project area to excessive noise levels?

The proposed project is not located within the vicinity of a private airstrip which could expose people residing or working in the project area to excessive noise levels. Therefore, no impacts expected.

	Potentially Significant Impact (PSI)	Potentially Significant Unless Mitigation Incorporated (PSUMI)	Less Than Significant Impact (LTSI)	No Impact (NI)
--	--------------------------------------	--	-------------------------------------	----------------

XIV. POPULATION AND HOUSING

Would the project:

- | | | | | |
|--|--------------------------|--------------------------|-------------------------------------|--------------------------|
| a) Induce substantial population growth in an area, either directly (for example, by proposing new homes and businesses) or indirectly (for example through extension of roads or other infrastructure)? | <input type="checkbox"/> | <input type="checkbox"/> | <input checked="" type="checkbox"/> | <input type="checkbox"/> |
|--|--------------------------|--------------------------|-------------------------------------|--------------------------|

The purpose of the project is to enhance the RV Park for their customers. Additionally, the trucks trips that carried away the effluent will now be reduced from 25 to 4 trips per year. It will not create a population growth, as the RV Park has a limit of 262 spaces. The proposed project may indirectly induce additional population growth from RV Park customers who visit Imperial County and may want to move here. However, due to our weather conditions that impact is expected to be less than significant.

- | | | | | |
|---|--------------------------|--------------------------|--------------------------|-------------------------------------|
| b) Displace substantial numbers of existing housing, necessitating the construction of replacement housing elsewhere? | <input type="checkbox"/> | <input type="checkbox"/> | <input type="checkbox"/> | <input checked="" type="checkbox"/> |
|---|--------------------------|--------------------------|--------------------------|-------------------------------------|

The expansion of the existing wastewater treatment facility does not propose to displace any existing home or necessitate construction of replacement housing elsewhere. Therefore, no impacts expected.

- | | | | | |
|---|--------------------------|--------------------------|--------------------------|-------------------------------------|
| c) Displace substantial numbers of people, necessitating the construction of replacement housing elsewhere? | <input type="checkbox"/> | <input type="checkbox"/> | <input type="checkbox"/> | <input checked="" type="checkbox"/> |
|---|--------------------------|--------------------------|--------------------------|-------------------------------------|

The expansion of the existing wastewater treatment facility does not anticipate displacing substantial number of people necessitating the need for construction of replacement housing elsewhere; therefore, no impacts expected.

XV. PUBLIC SERVICES

- | | | | | |
|---|--------------------------|--------------------------|--------------------------|-------------------------------------|
| a) Would the project result in substantial adverse physical impacts associated with the provision of new or physically altered governmental facilities, need for new or physically altered governmental facilities, the construction of which could cause significant environmental impacts, in order to maintain acceptable service ratios, response times or other performance objectives for any of the public services: | <input type="checkbox"/> | <input type="checkbox"/> | <input type="checkbox"/> | <input checked="" type="checkbox"/> |
|---|--------------------------|--------------------------|--------------------------|-------------------------------------|

The proposed project is the addition of a wastewater treatment system and will not create any impacts associated with the need for governmental facilities; therefore no impacts expected.

- | | | | | |
|---------------------|--------------------------|--------------------------|--------------------------|-------------------------------------|
| 1) Fire protection? | <input type="checkbox"/> | <input type="checkbox"/> | <input type="checkbox"/> | <input checked="" type="checkbox"/> |
|---------------------|--------------------------|--------------------------|--------------------------|-------------------------------------|

The expansion of the existing water treatment facility could require fire services during the construction or operation as a result of an accident; however, no need for new fire protection services will be required. Therefore, no impact expected.

- | | | | | |
|-----------------------|--------------------------|--------------------------|--------------------------|-------------------------------------|
| 2) Police protection? | <input type="checkbox"/> | <input type="checkbox"/> | <input type="checkbox"/> | <input checked="" type="checkbox"/> |
|-----------------------|--------------------------|--------------------------|--------------------------|-------------------------------------|

The addition of a wastewater treatment facility will not change the use of the facility and will not create a substantial change to police protection. Therefore, no impacts are expected

	Potentially Significant Impact (PSI)	Potentially Significant Unless Mitigation Incorporated (PSUMI)	Less Than Significant Impact (LTSI)	No Impact (NI)
3) Schools?	<input type="checkbox"/>	<input type="checkbox"/>	<input type="checkbox"/>	<input checked="" type="checkbox"/>
<i>The addition of the wastewater treatment facility will not result in impacts to schools; therefore no impacts expected.</i>				
4) Parks?	<input type="checkbox"/>	<input type="checkbox"/>	<input type="checkbox"/>	<input checked="" type="checkbox"/>
<i>The expansion of the existing water treatment facility will not result in any adverse impacts to parks. Therefore, no impacts are expected.</i>				
5) Other public facilities?	<input type="checkbox"/>	<input type="checkbox"/>	<input type="checkbox"/>	<input checked="" type="checkbox"/>
<i>The addition of the wastewater treatment system will upgrade the existing RV Park and will not have an impact on other public facilities; therefore, no impacts are expected.</i>				

XVI. RECREATION

a) Would the project increase the use of the existing neighborhood and regional parks or other recreational facilities such that substantial physical deterioration of the facility would occur or be accelerated?	<input type="checkbox"/>	<input type="checkbox"/>	<input type="checkbox"/>	<input checked="" type="checkbox"/>
<i>The addition of the wastewater treatment system will not increase the use of existing neighborhood and regional parks or other recreational facilities due to the limit of customers the park may have at any one time. Therefore, no impacts are expected.</i>				
b) Does the project include recreational facilities or require the construction or expansion of recreational facilities which might have an adverse effect on the environment?	<input type="checkbox"/>	<input type="checkbox"/>	<input type="checkbox"/>	<input checked="" type="checkbox"/>
<i>The addition of the wastewater treatment system will not result in the construction or expansion of recreational facilities. Therefore, no impact expected.</i>				

XVII. TRANSPORTATION / TRAFFIC

Would the project:

a) Conflict with an applicable plan, ordinance or policy establishing measures of effectiveness for the performance of the circulation system, taking into account all modes of transportation including mass transit and non-motorized travel and relevant components of the circulation system, including but not limited to intersections, streets, highways and freeways, pedestrian and bicycle paths, and mass transit?	<input type="checkbox"/>	<input type="checkbox"/>	<input checked="" type="checkbox"/>	<input type="checkbox"/>
<i>The addition of the wastewater treatment system will have an impact on surrounding roadway(s) during construction. The Imperial County Public Works Department will review the application package for a determination of impacts and at a minimum may require a commercial type driveway at the connection of Green Road. However, the impacts during the construction period are temporary and appear to be less than significant.</i>				
b) Conflict with an applicable congestion management	<input type="checkbox"/>	<input type="checkbox"/>	<input checked="" type="checkbox"/>	<input type="checkbox"/>

	Potentially Significant Impact (PSI)	Potentially Significant Unless Mitigation Incorporated (PSUMI)	Less Than Significant Impact (LTSI)	No Impact (NI)
--	--------------------------------------	--	-------------------------------------	----------------

program, including but not limited to level of service standard and travel demand measures, or other standards established by the county congestion/management agency for designated roads or highways?

The addition of the wastewater treatment facility does not conflict with any applicable congestion management program or other standards established by the County congestion/management agency for designated roads or highways. Therefore, any impacts should be less than significant.

- | | | | | |
|---|--------------------------|--------------------------|--------------------------|-------------------------------------|
| c) Result in a change in air traffic patterns, including either an increase in traffic levels or a change in location that results in substantial safety risks? | <input type="checkbox"/> | <input type="checkbox"/> | <input type="checkbox"/> | <input checked="" type="checkbox"/> |
|---|--------------------------|--------------------------|--------------------------|-------------------------------------|

The Brawley Airport is the nearest airport located approximately 6 miles west of the proposed project site as shown in the 1996 Airport Land Use Compatibility Plan and the addition of the wastewater facility will not result in a change to Brawley airport's traffic patterns. Therefore, no impacts are expected.

- | | | | | |
|--|--------------------------|--------------------------|--------------------------|-------------------------------------|
| d) Substantially increase hazards due to a design feature (e.g., sharp curves or dangerous intersections) or incompatible uses (e.g., farm equipment)? | <input type="checkbox"/> | <input type="checkbox"/> | <input type="checkbox"/> | <input checked="" type="checkbox"/> |
|--|--------------------------|--------------------------|--------------------------|-------------------------------------|

The addition of the wastewater treatment will not increase hazards due to design feature or incompatible use. Therefore, no impacts are expected.

- | | | | | |
|--|--------------------------|--------------------------|--------------------------|-------------------------------------|
| e) Result in inadequate emergency access | <input type="checkbox"/> | <input type="checkbox"/> | <input type="checkbox"/> | <input checked="" type="checkbox"/> |
|--|--------------------------|--------------------------|--------------------------|-------------------------------------|

The addition of the wastewater treatment system does not appear to result in inadequate emergency access. Therefore, no impact expected.

- | | | | | |
|---|--------------------------|--------------------------|--------------------------|-------------------------------------|
| f) Conflicts with adopted policies, plans, programs, regarding public transit, bicycle, or pedestrian facilities, or otherwise decrease the performance or safety of such facilities? | <input type="checkbox"/> | <input type="checkbox"/> | <input type="checkbox"/> | <input checked="" type="checkbox"/> |
|---|--------------------------|--------------------------|--------------------------|-------------------------------------|

The addition of the wastewater treatment facility will not conflict with adopted policies, plans or programs regarding public transit, bicycle, or pedestrian facilities or otherwise decrease the performance or safety of such facility. Therefore, no impacts are expected.

XVIII. TRIBAL CULTURAL RESOURCES

- | | | | | |
|--|--------------------------|--------------------------|--------------------------|-------------------------------------|
| a) Would the project cause a substantial adverse change in the significance of a tribal cultural resource, defined in Public Resources Code Section 21074 as either a site, feature, place, cultural landscape that is geographically defined in terms of the size and scope of the landscape, sacred place or object with cultural value to a California Native American tribe, and that is | <input type="checkbox"/> | <input type="checkbox"/> | <input type="checkbox"/> | <input checked="" type="checkbox"/> |
|--|--------------------------|--------------------------|--------------------------|-------------------------------------|

a) The project would not create a substantial adverse changes in the significance of a tribal cultural resource; therefore, no impact is expected

- | | | | | |
|--|--------------------------|--------------------------|--------------------------|-------------------------------------|
| (i) Listed or eligible for listing in the California | <input type="checkbox"/> | <input type="checkbox"/> | <input type="checkbox"/> | <input checked="" type="checkbox"/> |
|--|--------------------------|--------------------------|--------------------------|-------------------------------------|

	Potentially Significant Impact (PSI)	Potentially Significant Unless Mitigation Incorporated (PSUMI)	Less Than Significant Impact (LTSI)	No Impact (NI)
--	--------------------------------------	--	-------------------------------------	----------------

Register of Historical Resources, or in a local register of historical resources as define in Public Resources Code Section 5020.1(k), or

(i) A request was sent to the Historic Society and no response was received. No impact is expected.

0 (ii) A resource determined by the lead agency, in its discretion and supported by substantial evidence, to be significant pursuant to criteria set forth in subdivision (c) of Public Resources Code Section 5024.1. In applying the criteria set forth in subdivision (c) of Public Resource Code Section 5024.1, the lead agency shall consider the significance of the resource to a California Native American Tribe.

(ii) The proposed project site is located within the DRECP (BLM) Native American Element per Figure 2.3-3 of the Conservation Open Space Element. However, we requested consultation per AB 52 and received no responses. Therefore, any impacts is considered less than significant.

XIX. UTILITIES AND SERVICE SYSTEMS

Would the project:

a) Exceed wastewater treatment requirements of the applicable Regional Water Quality Control Board?

The addition of the wastewater treatment system is needed to serve the existing Dune Edge RV Park customers. The addition will improve the facility by reducing the number of trucks that go onsite to dispose of waste. Also the design has been approved by Colorado River Basin Regional Quality Control Board. Therefore, any impact should be less than significant.

b) Require or result in the construction of new water or water treatment facilities or expansion of existing facilities, the construction of which could cause significant environmental effects?

The project is the addition of a wastewater treatment; however, no impact is expected since the footprint will remain the same.

c) Require or result in the construction of new storm water drainage facilities or expansion of existing facilities, the construction of which could cause significant environmental effects?

The addition of the wastewater treatment facility will require a retention basin, which will be reviewed by the I. C. Public Works Department once the grading and drainage plan is submitted. Additionally, a Management Plan for the retention area may be required by the Environmental Health Services Department (EHS); therefore any impacts should be less than significant.

d) Have sufficient water supplies available to serve the project from existing entitlements and resources, or are new or expanded entitlements needed?

The proposed project is the addition of a wastewater treatment facility to reduce the numbered of trucks removing

	Potentially Significant Impact (PSI)	Potentially Significant Unless Mitigation Incorporated (PSUMI)	Less Than Significant Impact (LTSI)	No Impact (NI)
--	--------------------------------------	--	-------------------------------------	----------------

the waste. The current water source is from the Imperial Irrigation District (IID) Canal via Green Road. Currently, IID delivers approximately 1-acre foot of raw water per year. No new entitlements are needed for water; therefore, any impact are expected to be less than significant.

- | | | | | |
|---|--------------------------|--------------------------|-------------------------------------|--------------------------|
| e) Result in a determination by the wastewater treatment provider which serves or may serve the project that it has adequate capacity to serve the project's projected demand in addition to the provider's existing commitments? | <input type="checkbox"/> | <input type="checkbox"/> | <input checked="" type="checkbox"/> | <input type="checkbox"/> |
|---|--------------------------|--------------------------|-------------------------------------|--------------------------|

The proposed project is the addition of a wastewater treatment facility needed to accommodate existing and projected demands from customers within RV Park. Therefore, any impacts that may result from the addition should be less than significant.

- | | | | | |
|--|--------------------------|--------------------------|-------------------------------------|--------------------------|
| f) Be served by a landfill with sufficient permitted capacity to accommodate the project's solid waste disposal needs? | <input type="checkbox"/> | <input type="checkbox"/> | <input checked="" type="checkbox"/> | <input type="checkbox"/> |
|--|--------------------------|--------------------------|-------------------------------------|--------------------------|

The proposed project will be required to contract with an approved waste hauler for solid waste and comply with federal, state and local statutes and regulation related to solid waste; therefore, any impact are expected to be less than significant.

- | | | | | |
|---|--------------------------|--------------------------|-------------------------------------|--------------------------|
| g) Comply with federal, state, and local statutes and regulations related to solid waste? | <input type="checkbox"/> | <input type="checkbox"/> | <input checked="" type="checkbox"/> | <input type="checkbox"/> |
|---|--------------------------|--------------------------|-------------------------------------|--------------------------|

As stated above, the proposed project shall comply with federal, state and local statutes and regulation related to solid waste; therefore, any impact are expected to be less than significant.

XX. WILDFIRE

If located in or near state responsibility areas or lands classified as very high fire hazard severity zones, would the Project:

- | | | | | |
|--|--------------------------|--------------------------|--------------------------|-------------------------------------|
| a) Substantially impair an adopted emergency response plan or emergency evacuation plan? | <input type="checkbox"/> | <input type="checkbox"/> | <input type="checkbox"/> | <input checked="" type="checkbox"/> |
|--|--------------------------|--------------------------|--------------------------|-------------------------------------|

a) The project will not impair an adopted emergency response plan of emergency evacuation plan; therefore, no impact is expected.

- | | | | | |
|---|--------------------------|--------------------------|-------------------------------------|--------------------------|
| b) Due to slope, prevailing winds, and other factors, exacerbate wildfire risks, and thereby expose project occupants to pollutant concentrations from a wildfire or the uncontrolled spread of a wildfire? | <input type="checkbox"/> | <input type="checkbox"/> | <input checked="" type="checkbox"/> | <input type="checkbox"/> |
|---|--------------------------|--------------------------|-------------------------------------|--------------------------|

b) The proposed project is on flat terrain and minimum shrubs, is not expected to create the spread of a wildfire; therefore impacts are expected to be less than significant.

- | | | | | |
|--|--------------------------|--------------------------|--------------------------|-------------------------------------|
| c) Require the installation or maintenance of associated infrastructure (such as roads, fuel breaks, emergency water sources, power lines or other utilities) that may exacerbate fire risk or that may result in temporary or ongoing impacts to the environment? | <input type="checkbox"/> | <input type="checkbox"/> | <input type="checkbox"/> | <input checked="" type="checkbox"/> |
|--|--------------------------|--------------------------|--------------------------|-------------------------------------|

c) Imperial County is not a high fire hazards severity zone so it is not likely roads, emergency water sources will not be needed. Therefore, no impact is expected.

	<i>Potentially Significant Impact (PSI)</i>	<i>Potentially Significant Unless Mitigation Incorporated (PSUMI)</i>	<i>Less Than Significant Impact (LTSI)</i>	<i>No Impact (NI)</i>
--	---	---	--	-----------------------

- d) Expose people or structures to significant risks, including downslope or downstream flooding or landslides, as a result of runoff, post-fire slope instability, or drainage changes?

d) As stated above the propose project area is not in a high fire hazards severity zone and should not expose people to flooding because of a wildfire. Therefore, no impact is expected.

Note: Authority cited: Sections 21083 and 21083.05, Public Resources Code. Reference: Section 65088.4, Gov. Code; Sections 21080(c), 21080.1, 21080.3, 21083, 21083.05, 21083.3, 21093, 21094, 21095, and 21151, Public Resources Code; Sundstrom v. County of Mendocino, (1988) 202 Cal.App.3d 296; Leonoff v. Monterey Board of Supervisors, (1990) 222 Cal.App.3d 1337; Eureka Citizens for Responsible Govt. v. City of Eureka (2007) 147 Cal.App.4th 357; Protect the Historic Amador Waterways v. Amador Water Agency (2004) 116 Cal.App.4th at 1109; San Franciscans Upholding the Downtown Plan v. City and County of San Francisco (2002) 102 Cal.App.4th 656.

Revised 2009- CEQA
Revised 2011- ICPDS

(Written or oral comments received on the checklist prior to circulation)

<i>Potentially Significant Impact (PSI)</i>	<i>Potentially Significant Unless Mitigation Incorporated (PSUMI)</i>	<i>Less Than Significant Impact (LTSI)</i>	<i>No Impact (NI)</i>
---	---	--	-----------------------

III. MANDATORY FINDINGS OF SIGNIFICANCE

The following are Mandatory Findings of Significance in accordance with Section 15065 of the CEQA Guidelines.

- | | | | | |
|--|--------------------------|--------------------------|-------------------------------------|-------------------------------------|
| a) Does the project have the potential to degrade the quality of the environment, substantially reduce the habitat of a fish or wildlife species, cause a fish or wildlife population to drop below self-sustaining levels, threaten to eliminate a plant or animal community, reduce the number or restrict the range of a rare or endangered plant or animal or eliminate important examples of the major periods of California history or prehistory? | <input type="checkbox"/> | <input type="checkbox"/> | <input type="checkbox"/> | <input checked="" type="checkbox"/> |
| b) Does the project have impacts that are individually limited, but cumulatively considerable? ("Cumulatively considerable" means that the incremental effects of a project are considerable when viewed in connection with the effects of past projects, the effects of other current projects, and the effects of probable future projects.) | <input type="checkbox"/> | <input type="checkbox"/> | <input checked="" type="checkbox"/> | <input type="checkbox"/> |
| c) Does the project have environmental effects, which will cause substantial adverse effects on human beings, either directly or indirectly? | <input type="checkbox"/> | <input type="checkbox"/> | <input checked="" type="checkbox"/> | <input type="checkbox"/> |

IV. PERSONS AND ORGANIZATIONS CONSULTED

This section identifies those persons who prepared or contributed to preparation of this document. This section is prepared in accordance with Section 15129 of the CEQA Guidelines.

A. COUNTY OF IMPERIAL

- Jim Minnick, Director of Planning & Development Services
- Michael Abraham, Assistant Director of Planning & Development Services
- Patricia Valenzuela, Project Planner III
- Imperial County Air Pollution-Control District
- Department of Public Works
- Fire Department
- Agricultural Commissioner
- Environmental Health Services
- Sheriff's Office

B. OTHER AGENCIES/ORGANIZATIONS

- Regional Water Quality Control Board
- Caltrans – District II
- Imperial Irrigation District
- Colorado River Basin Regional Water Quality Control Board
-

(Written or oral comments received on the checklist prior to circulation)

VI. REFERENCES

1. "County of Imperial General Plan EIR", prepared by Brian F. Mooney & Associates in 1993; and as Amended by County in 1996, 1998, 2001, 2003, 2006 & 2008
2. "County of Imperial Airport Land Use Compatibility Plan dated June 1996

VII. NEGATIVE DECLARATION – County of Imperial

The following Negative Declaration is being circulated for public review in accordance with the California Environmental Quality Act Section 21091 and 21092 of the Public Resources Code.

Project Name: Conditional Use Permit #20-0015

Project Applicant: Kyle Vestermark Dunes Edge RV Storage

Project Location: 2496 E Highway 78, Brawley, CA

Description of Project:

The proposed project is to install an onsite wastewater treatment system (OWTS) to treat the effluent from the RV dump-holding tank. This will eliminate all but two of the 28 pump outs that occurred in 2019, reducing the environmental impacts caused from the use of the semi-truck trips used to remove the effluent.

The OWTS will consist of the following components: 1) new primary 10,000-gallon holding tank. This tank will have an internal partition to facilitate the removal of primary solids; 2) The secondary existing 10,000 gallon holding tank will also have an internal partition for primary solids removal and will act as a “wide” spot in the line in the 2nd chamber of the tank during the week prior to the (5) know “HIGH RV DUMP” WEEKEND. This tank will gravity feed into the new 500 gallon Pump tank; 3) A new 500 gallon float operated pump tank will discharge the effluent from the Secondary 10,000 gallon holding tank to the Facultative Pond; 4) The Facultative pond will have a trickle filter, a pond divider to enhance the nitrification/de-nitrification process, a liner to eliminate any seepage, and greater than 12” of freeboard. It will have dimension of 30’ wide x 78’ long x five-6” deep and surface area of 2,340. The pond will have a total volume of 75,000 gallons per “Gloyna Method” calculation. The Facultative pond will gravity fee to a Constructed Wetlands (CW) pond.; 5) The CD pond will be a Free Water Surface (FWS) design, will be lined and will have a nitrogen filtration bed (NFB) It will have dimension of 15” wide x 50” long with a varying depth of 18” to 2” and a surface area of 750 feet. It will have aquatic plants, greater than 12’ of freeboard and will gravity drain to a new Subsurface Wastewater Infiltration System (SWIS) leach field. 6) The SWIS will be constructed with high capacity infiltrator chambers in (3) rows lengths of 56’.

FINDINGS

This is to advise that the County of Imperial, acting as the lead agency, has conducted an Initial Study to determine if the project may have a significant effect on the environmental and is proposing this Negative Declaration based upon the following findings:

- The Initial Study shows that there is no substantial evidence that the project may have a significant effect on the environment and a NEGATIVE DECLARATION will be prepared.
- The Initial Study identifies potentially significant effects but:
- (1) Proposals made or agreed to by the applicant before this proposed Mitigated Negative Declaration was released for public review would avoid the effects or mitigate the effects to a point where clearly no significant effects would occur.
 - (2) There is no substantial evidence before the agency that the project may have a significant effect on the environment.
 - (3) Mitigation measures are required to ensure all potentially significant impacts are reduced to levels of insignificance.

A NEGATIVE DECLARATION will be prepared.

If adopted, the Negative Declaration means that an Environmental Impact Report will not be required. Reasons to support this finding are included in the attached Initial Study. The project file and all related documents are available for review at the County of Imperial, Planning & Development Services Department, 801 Main Street, El Centro, CA 92243 (760) 482-4236.

NOTICE

The public is invited to comment on the proposed Negative Declaration during the review period.

4-21-2021
Date of Determination

for [Signature]
Jim Minnick, Director of Planning

The Applicant hereby acknowledges and accepts the results of the Environmental Evaluation Committee (EEC) and hereby agrees to implement all Mitigation Measures, if applicable, as outlined in the MMRP.

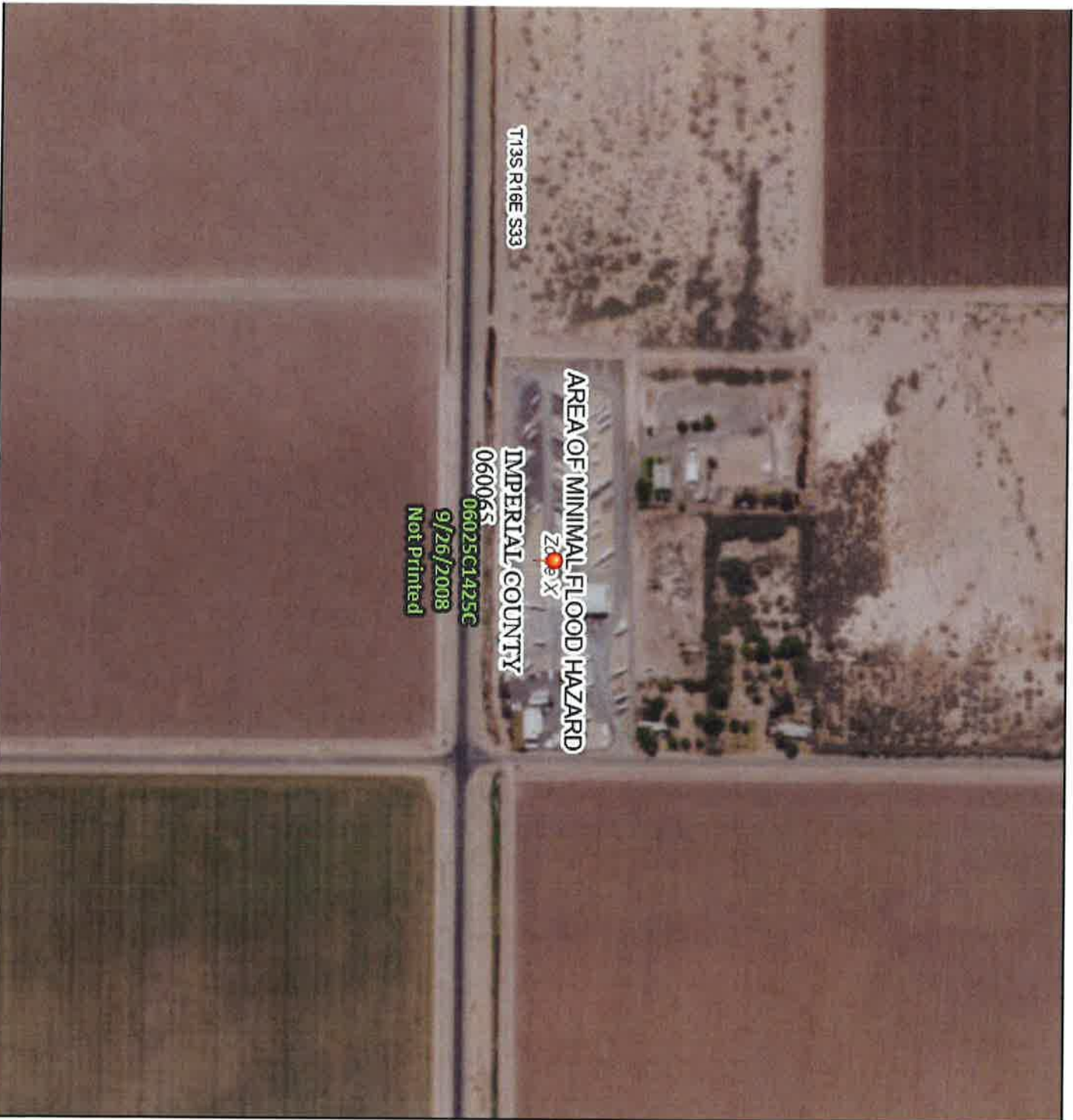
Applicant Signature

Date

S:\ALLUSERS\APN\039\120\027\CUP20-0015\EEC\INITIAL STUDY FOR kyle wassternark 3.3921.DOCX

National Flood Hazard Layer FIRMeTte

115°19'51"W 32°58'46"N



115°19'14"W 32°58'16"N

Legend

SEE FIS REPORT FOR DETAILED LEGEND AND INDEX MAP FOR FIRM PANEL AVOUT

SPECIAL FLOOD HAZARD AREAS	Without Base Flood Elevation (BFE) Zone A, V, A99 With BFE or Depth Zone AE, AO, AH, VE, AR Regulatory Floodway
-----------------------------------	--

0.2% Annual Chance Flood Hazard, Area of 1% annual chance flood with average depth less than one foot or with drainage areas of less than one square mile Zone
--

Future Conditions 1% Annual Chance Flood Hazard Zone X Area with Reduced Flood Risk due to Levee. See Notes, Zone X Area with Flood Risk due to Levee Zone C
--

OTHER AREAS OF FLOOD HAZARD	NO SCREEN Area of Minimal Flood Hazard Zone X Effective LOMRS Area of Undetermined Flood Hazard Zone
------------------------------------	---

GENERAL STRUCTURES	Channel, Culvert, or Storm Sewer Levee, Dike, or Floodwall
---------------------------	---

Cross Sections with 1% Annual Chance	20.2 17.5 8 59 Water Surface Elevation Coastal Transect Base Flood Elevation Line (BFE) Limit of Study Jurisdiction Boundary Coastal Transect Baseline Profile Baseline Hydrographic Feature
---	---

OTHER FEATURES	Digital Data Available No Digital Data Available Unmapped
-----------------------	---

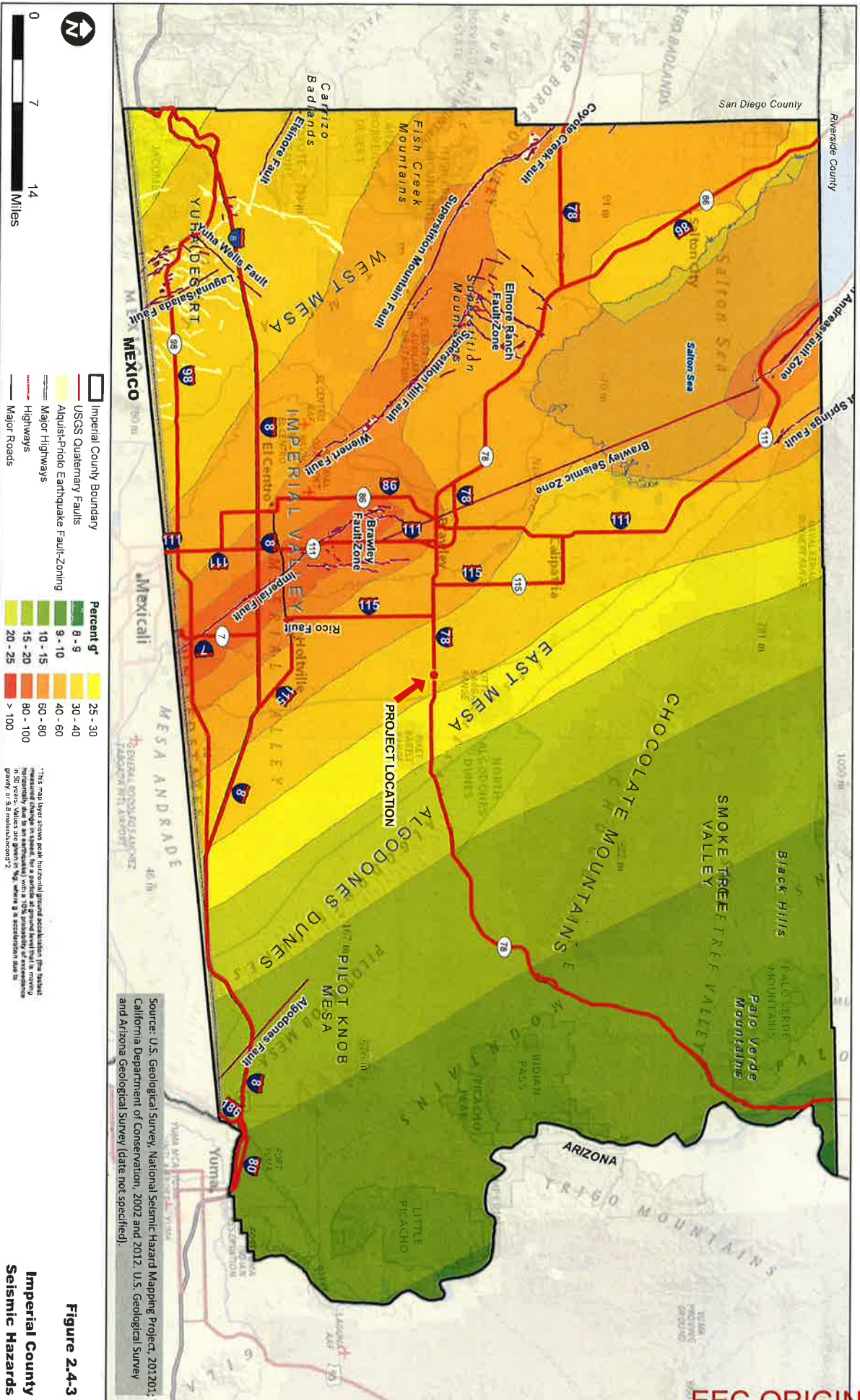
MAP PANELS

The pin displayed on the map is an approximate point selected by the user and does not represent an authoritative property location.

This map complies with FEMA's standards for the use of digital flood maps if it is not void as described below. The basemap shown complies with FEMA's basemap accuracy standards.

The flood hazard information is derived directly from the authoritative NFHL web services provided by FEMA. This map was exported on **4/1/2021 at 6:59 PM** and does not reflect changes or amendments subsequent to this date and time. The NFHL and effective information may change or become superseded by new data over time.

This map image is void if the one or more of the following map elements do not appear: basemap imagery, flood zone labels, legend, scale bar, map creation date, community identifiers, FIRM panel number, and FIRM effective date. Map images for unmapped and unmodernized areas cannot be used for regulatory purposes.



February 2015

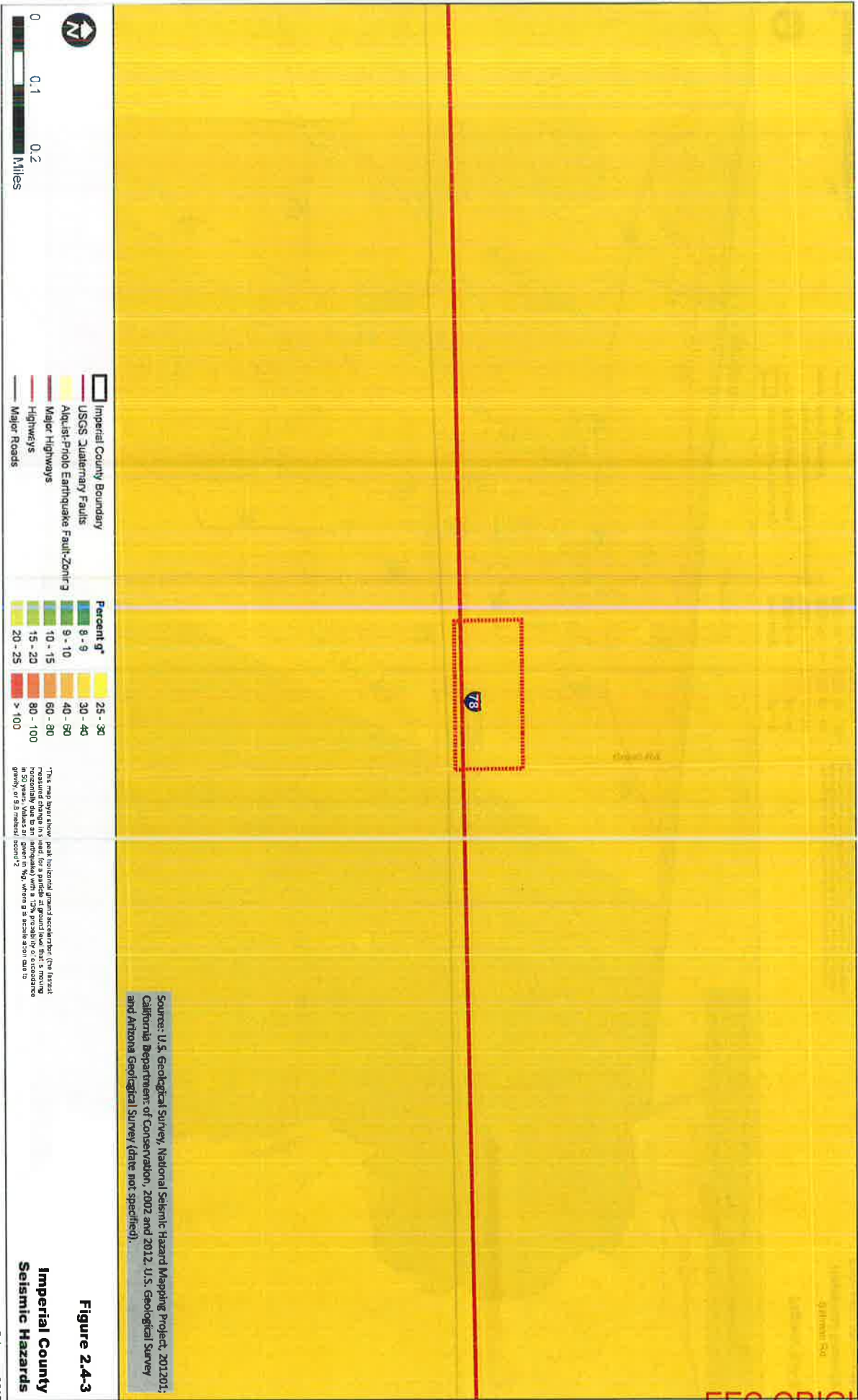
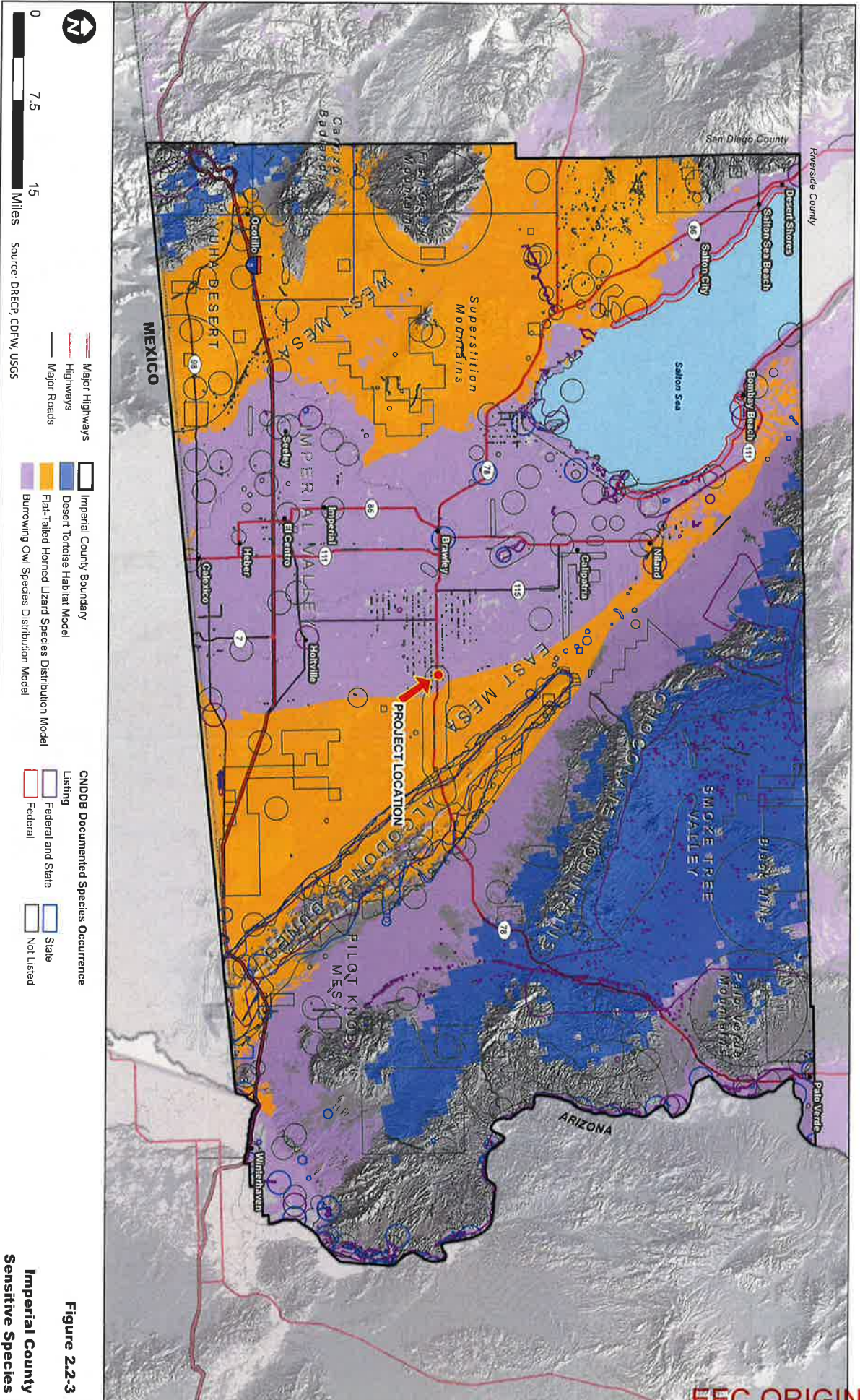
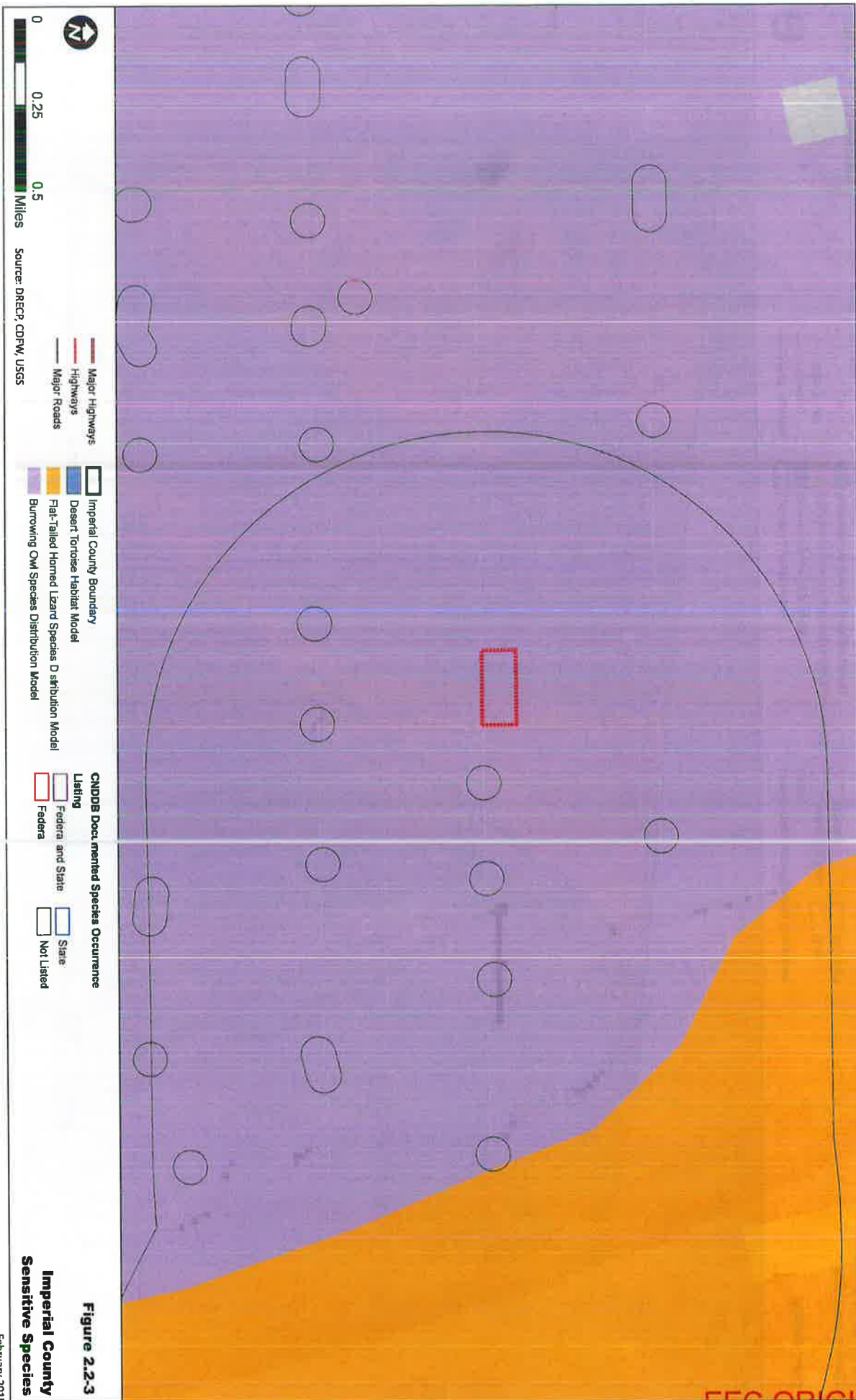


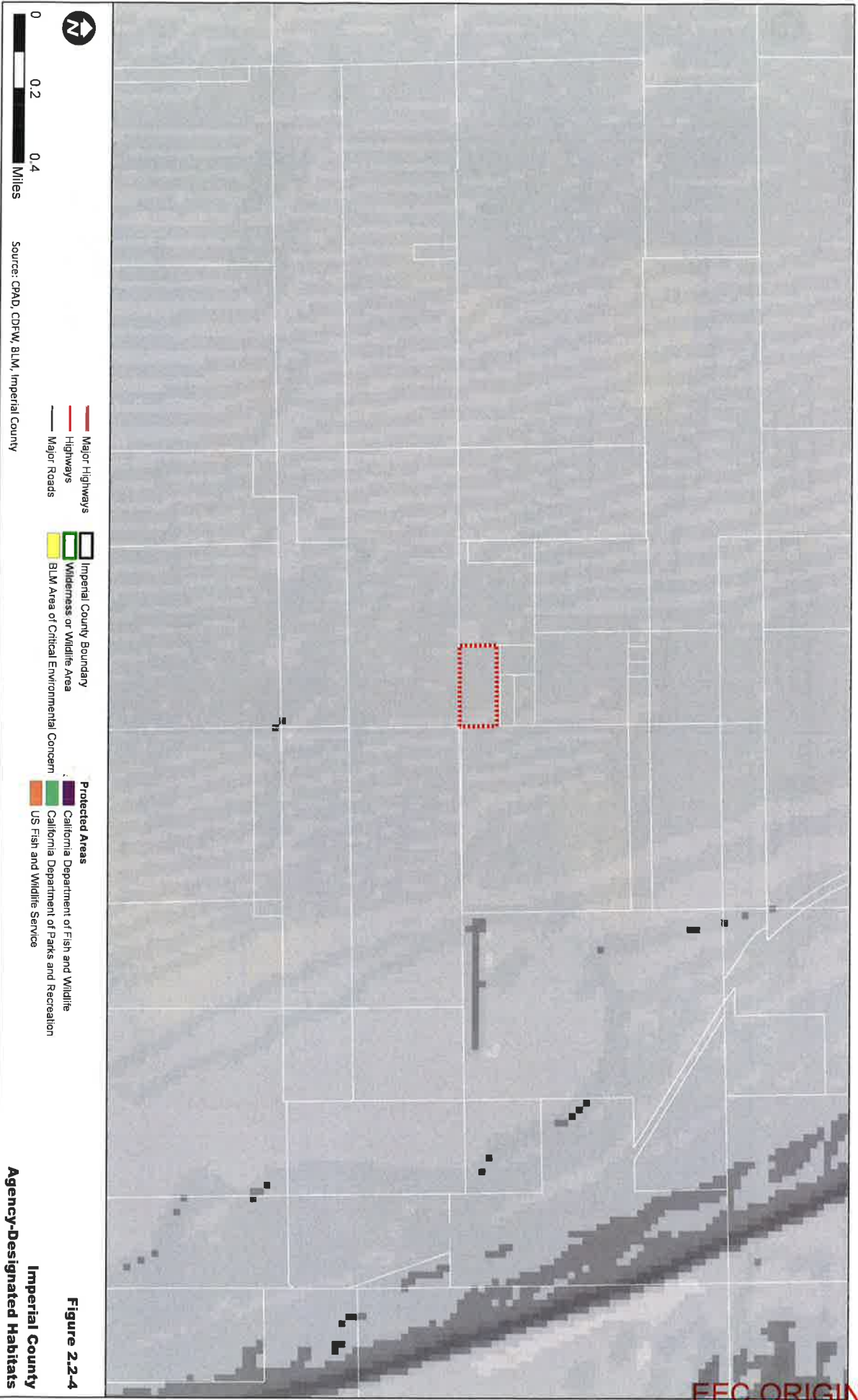
Figure 2.4-3

**Imperial County
Seismic Hazards**

February 2015







Source: CRAD, CDFW, BLM, Imperial County

Figure 2.2-4
Imperial County
Agency-Designated Habitats

February 2015

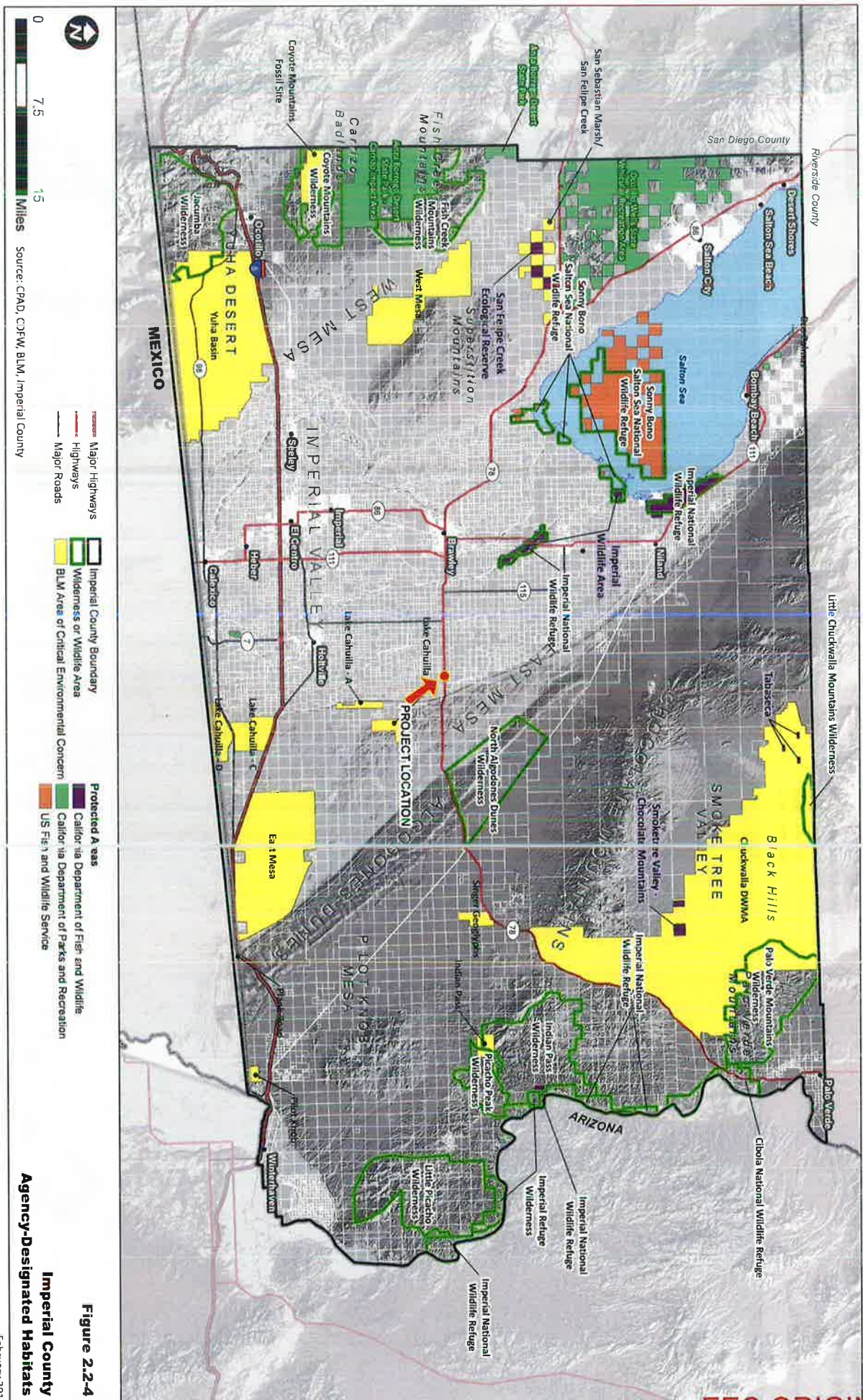


Figure 2.2-4
Imperial County
Agency-Designated Habitats

February 2015

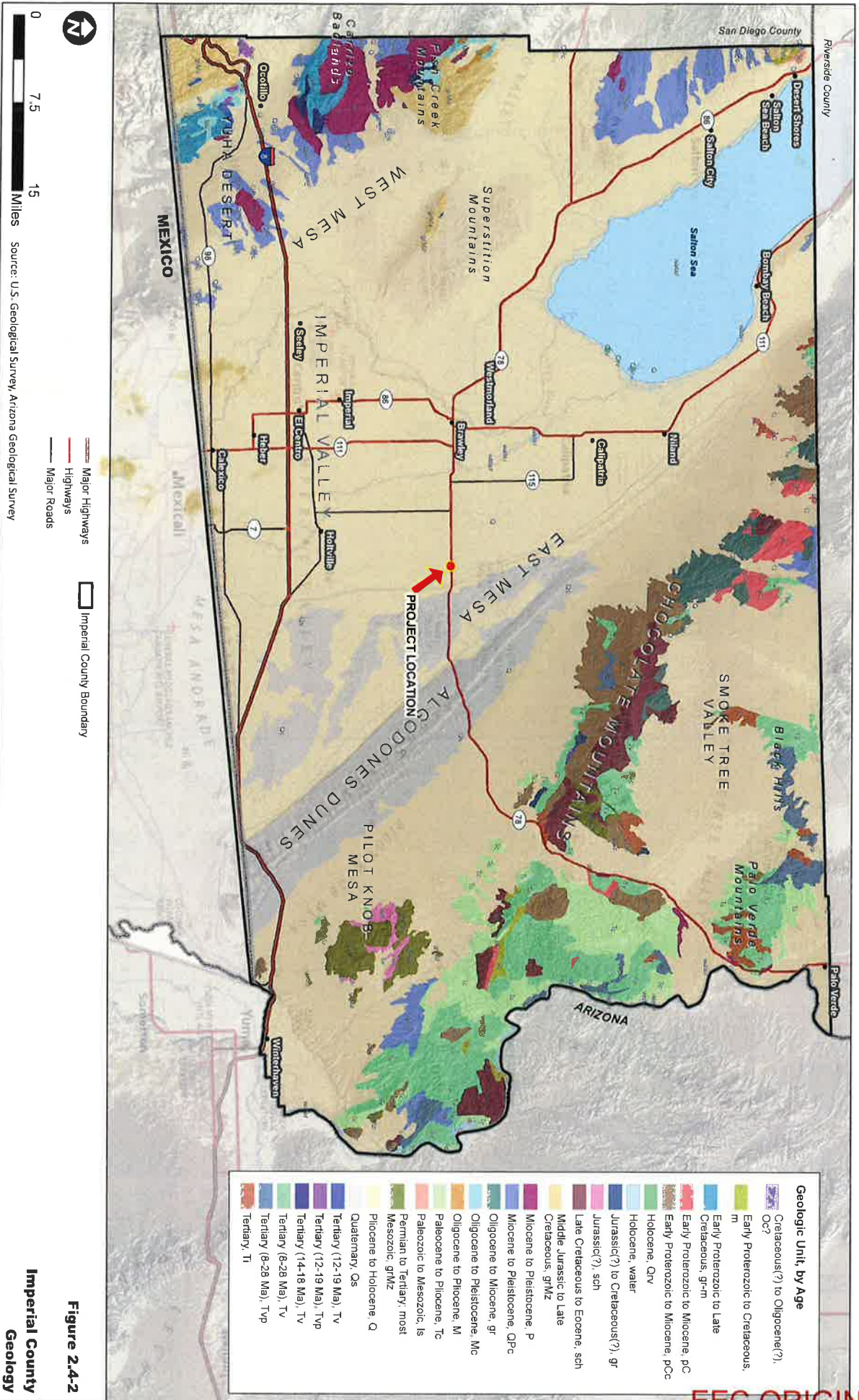


Figure 2.4-2

**Imperial County
Geology**

February 2015

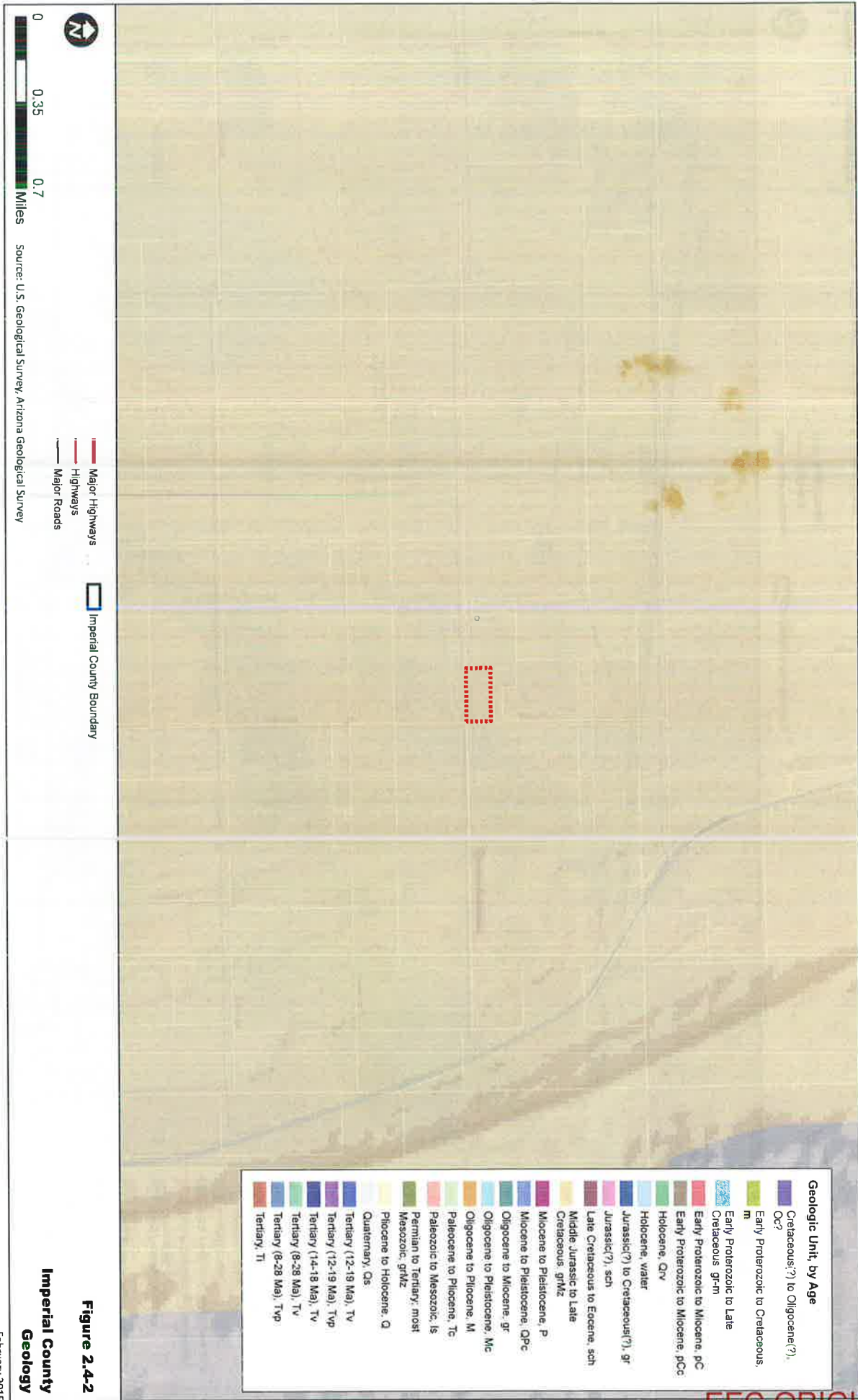


Figure 2.4-2
Imperial County
Geology

February 2015

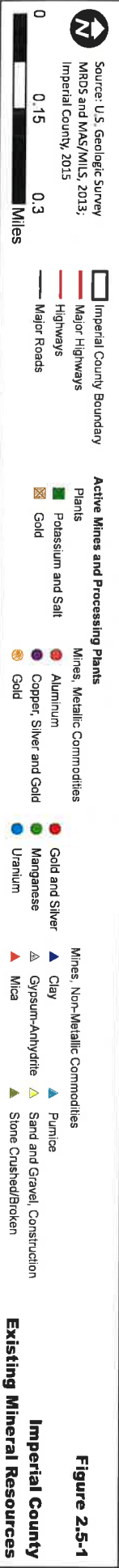
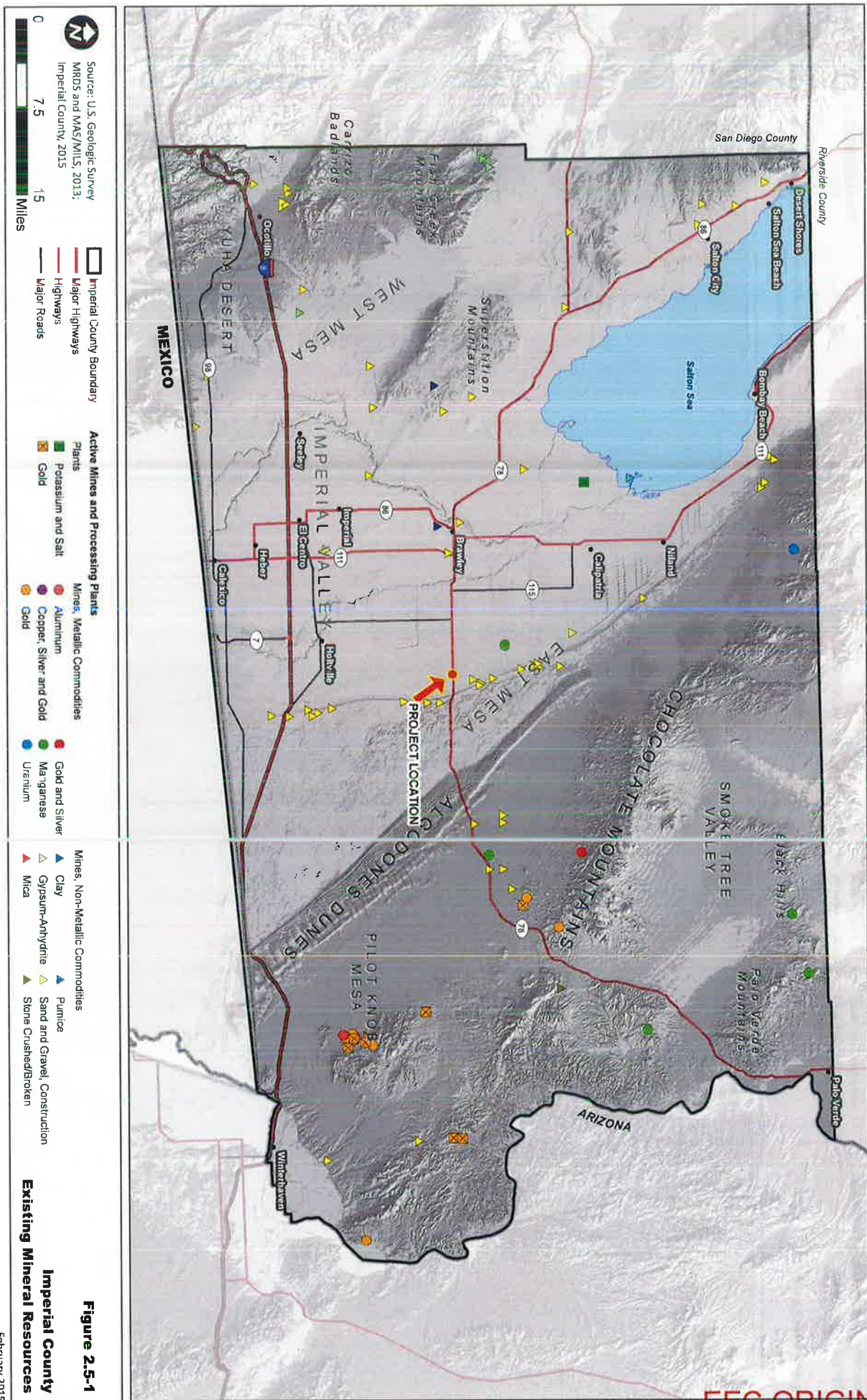


Figure 2.5-1

**Imperial County
Existing Mineral Resources**

February 2015



AIR POLLUTION CONTROL DISTRICT



April 1, 2021

Jim Minnick, Director
Imperial County Planning & Development Services
801 Main Street
El Centro, CA 92243

SUBJECT: Conditional Use Permit (CUP) 20-0015 —RV Wastewater Treatment Storage: 2nd Response

Dear Mr. Minnick:

The Imperial County Air Pollution Control District ("Air District") thanks you for the opportunity to revisit the prior review of Conditional Use Permit (CUP) 20-0015 that would allow the construction of a Recreational Vehicle Wastewater Treatment System at 2496 East Highway 78 in Brawley, California (also identified as Assessor's Parcel Number 039-120-027-000).

Under the California Environmental Quality Act (CEQA) §15063 the purpose of an Initial Study is to determine if a project may have a significant effect on the environment. In its first response the Air District identified emissions of fugitive dust (PM10) during construction and odors during operation as possible significant effects. Fugitive dust mitigation during construction and earthmoving can be accomplished through adherence to the Air District's Regulation VIII. The US Environmental Protection Agency (USEPA) has identified odor generation as a major concern with constructed wetland wastewater treatment systems. Therefore, the Air District requests that signage approved by the Planning and Development Services Department be visibly posted at multiple locations at the Project site that identifies a contact agency with a current telephone contact number for the public to report odors.. Finally, additional consultation may be required with the Air District's Permitting and Engineering Division for any fuel burning equipment (such as pumps) required during Project operations.

The applicant may review Air District Rules and Regulations at www.https://apcd.imperialcounty.org. The Imperial County CEQA Air Quality Handbook can be found accessed through the Planning drop-down menu.

Please feel free to contact the Air District should you have any questions at (442) 265-1800.

Respectfully,



Curtis Blondell
APC Environmental Coordinator



Reviewed by,
Monica Soucier
APC Division Manager



November 4, 2020

Jim Minnick, Director
Imperial County Planning & Development Services
801 Main Street
El Centro, CA 92243

RECEIVED

NOV 04 2020

IMPERIAL COUNTY
PLANNING & DEVELOPMENT SERVICES

SUBJECT: Conditional Use Permit (CUP) 20-0015 —RV Wastewater Treatment Storage

Dear Mr. Minnick:

The Imperial County Air Pollution Control District ("Air District") would like to thank you for the opportunity to review and comment on Conditional Use Permit (CUP) 20-0015 that would allow the construction of a Recreational Vehicle Wastewater Treatment System at 2496 East Highway 78 in Brawley, California (also identified as Assessor's Parcel Number 039-120-027-000).

The applicant should be aware that projects of this nature raise air quality concerns both through emissions of fugitive dust (PM10) during construction and from odors during operation. Fugitive dust mitigation during construction and earthmoving can be accomplished through adherence to the Air District's Regulation VIII. The applicant should be aware that the US Environmental Protection Agency (USEPA) has identified odor generation as a major concern with constructed wetland wastewater treatment systems.¹ Further, Table 3—Project Screening Distances for Potential Odor Sources of Section 4.6—Special Conditions in the *Imperial County California Environmental Quality Act (CEQA) Air Quality Handbook* identifies a Wastewater Treatment Plant as one type of project that requires special screening. Therefore, due to neighboring sensitive receptors which may be affected by Project odor emissions, the applicant is asked that proposed mitigation measures identified in the USEPA document referenced above be submitted for Air District review. Additional consultation may be required with the Air District's Permitting and

¹ US Environmental Protection Agency. (2000, September). *Constructed Wetlands Treatment of Municipal Waters*. Office of Research and Development Cincinnati, Ohio. Publication EPA/625/R-99/010. Retrieved from <http://www.epa.gov/ORD/NRMRL>.

Engineering Division for any fuel burning equipment (such as pumps) required during Project operations.


The applicant may review Air District Rules and Regulations at www.apcd.imperialcounty.org. The Imperial County CEQA Air Quality Handbook can be found accessed through the Planning drop-down menu.

Please feel free to contact the Air District should you have any questions at (442) 265-1800.

Respectfully,



Curtis Blondell
APC Environmental Coordinator



Reviewed by,
Monica Soucier
APC Division Manager

Kimberly Noriega

From: Carlos Yee
Sent: Thursday, October 29, 2020 8:38 AM
To: Patricia Valenzuela
Cc: ICPDSComentLetters
Subject: CUP 20-0015 Kyle Vestermark - RV Wastewater Treatment System

Good morning Patricia,

Based on the information provided our Department has the following comments:

1. The CUP application was completed for an onsite wastewater treatment system to be installed at the property with APN 039-120-027 (RV Storage Site). Per the documents submitted with the application and information obtained from GeoViewer, a pipeline for the wastewater treatment system extends north from this property through the neighbor property with APN 039-120-030 and to the north property with APN 039-120-026. On this last property (APN 039-120-026) is where half if not most of the treatment system is proposed for installation. Only one APN is listed on the application. The CUP application shall list all applicable APNs.
 2. The properties with APNs 039-120-027 and 039-120-030 are listed on GeoViewer as owned by the applicant. The property with APN 039-120-026 is listed on GeoViewer having a different owner. One of the application attachments indicates that this last property is also owned by the applicant. Please confirm that the three properties are owned by the applicant. In the event that any of the three properties is owned by a party other than the applicant, a copy of an agreement between such property owner and the applicant for the proposed project shall be submitted to this department.
 3. One of the application attachments illustrates the property with APN 039-120-030 as an "Access Road Easement". Information from GeoViewer suggests that this property serves as the only legal access to the property northwest to the RV Storage Site (APN 039-120-028). An agreement for the installation of the treatment pipeline shall be executed between the applicant and the owner of the property to the northwest and a copy be provided to this department.
 4. It appears the applicant is building a portion of the project on someone else's property to me. The neighbor needs to consent to the project by signing the Conditional Use Permit application, indemnify the County, and signing the future building permit application.
- Informative: the forthcoming design for the delivery of sewerage must be signed, sealed, and dated by a person authorized to practice civil engineering.

Regards.

Carlos Yee | Permit Specialist
ICDPW - Engineering Division | 155 S. 11th Street. El Centro, CA 92243
Phone: (442)265-1818 x1838 | Fax: (442)265-1858 | Email: CarlosYee@co.imperial.ca.us

Due to the Coronavirus (COVID-19) National Emergency

NO WALK-IN SERVICE AVAILABLE.

Contact us for an appointment.

Phone (442) 265-1818 Fax: (442) 265-1858

Email: icpw@co.imperial.ca.us

RECEIVED

OCT 29 2020

**IMPERIAL COUNTY
PLANNING & DEVELOPMENT SERVICES**



IID

A century of service.

www.iid.com

Since 1911

November 2, 2020

Ms. Patricia Valenzuela
Planner IV
Planning & Development Services Department
County of Imperial
801 Main Street
El Centro, CA 92243

RECEIVED

NOV 02 2020

IMPERIAL COUNTY
PLANNING & DEVELOPMENT SERVICES

SUBJECT: Dune Edge RV Storage Wastewater Treatment System; CUP No. 20-0015

Dear Ms. Valenzuela:

On October 21, 2020, the Imperial Irrigation District received from the Imperial County Planning & Development Services Department, a request for agency comments on Conditional Use Permit application no. 02490. The applicant, Kyle Vestermark, proposes to install a wastewater treatment system at Dune Edge RV Storage located at 2496 East Highway 78, Brawley, California (APN 039-120-027-000).

The Imperial Irrigation District has reviewed the information and has the following comments:

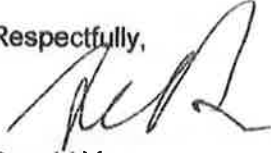
1. If the project requires increasing the existing electrical load and electrical service panel size, the applicant should be advised to contact Ignacio Romo, IID Customer Project Development Planner, at (760) 482-3426 or e-mail Mr. Romo at igromo@iid.com to initiate the customer service application process. In addition to submitting an application (available at <http://www.iid.com/home/showdocument?id=12923>), the applicant will be required to submit a complete set of approved plans (including CAD files), construction schedule, completion date, one-line electrical diagrams, electrical loads, panel sizes, and the applicable fees, permits, easements and environmental compliance documentation pertaining to the provision of electrical service to the dwellings. The applicants shall be responsible for all costs and mitigation measures related to providing electrical service to the dwellings.
2. Any construction or operation on IID property or within its existing and proposed right of way or easements including but not limited to: surface improvements such as proposed new streets, driveways, parking lots, landscape; and all water, sewer, storm water, or any other above ground or underground utilities; will require an encroachment permit, or encroachment agreement (depending on the circumstances). The IID encroachment permit application and instructions are available at <https://www.iid.com/about-iid/department-directory/real-estate>. The IID Real Estate Section should be contacted at (760) 339-9239 for additional information regarding encroachment permits or agreements.
3. Any new, relocated, modified or reconstructed IID facilities required for and by the project (which can include but is not limited to electrical utility substations, electrical transmission and distribution lines, etc.) need to be included as part of the project's CEQA and/or NEPA

Patricia Valenzuela
November 2, 2020
Page 2

documentation, environmental impact analysis and mitigation. Failure to do so will result in postponement of any construction and/or modification of IID facilities until such time as the environmental documentation is amended and environmental impacts are fully analyzed. **Any and all mitigation necessary as a result of the construction, relocation and/or upgrade of IID facilities is the responsibility of the project proponent.**

Should you have any questions, please do not hesitate to contact me at 760-482-3609 or at dvargas@iid.com. Thank you for the opportunity to comment on this matter.

Respectfully,



Donald Vargas
Compliance Administrator II

Enrique B. Martinez – General Manager
Mike Pacheco – Manager, Water Dept.
Marilyn Del Bosque Gilbert – Manager, Energy Dept.
Sandra Blain – Deputy Manager, Energy Dept.
Constance Bergmark – Mgr. of Planning & Eng./Chief Elect. Engineer, Energy Dept.
Jamie Asbury – Assoc. General Counsel
Vance Taylor – Asst. General Counsel
Michael P. Kemp – Superintendent, Regulatory & Environmental Compliance
Laura Cervantes – Supervisor, Real Estate
Jessica Humes – Environmental Project Mgr. Sr., Water Dept.

EEC ORIGINAL PKG



Imperial County Planning & Development Services Planning / Building

Jim Minnick
DIRECTOR

RECEIVED

NOV 04 2020

IMPERIAL COUNTY
PLANNING & DEVELOPMENT SERVICES

October 20, 2020

REQUEST FOR REVIEW
AND COMMENT LETTER

The attached project and materials are being sent to you for your review and as an early notification that the following project is being requested and being processed by the County's Planning & Development Services Department. Please review the proposed project based on your agency/department area of interest, expertise, and/or jurisdiction.

To: County Agencies	State Agencies/Other	Cities/Other
<input checked="" type="checkbox"/> County Executive Office – Esperanza Collo Warren	<input type="checkbox"/> CHP (Imperial Office) Arturo Proctor/Wes Boerner	<input checked="" type="checkbox"/> Caltrans, District 11 –Belh Landrum
<input checked="" type="checkbox"/> AG – Sandra Mendivil	<input checked="" type="checkbox"/> Dept of Fish & Wildlife – Magdalena Rodriguez	<input checked="" type="checkbox"/> APCD – Matt Dessert/Monica Soucier
<input checked="" type="checkbox"/> County Counsel – Adam Cook	<input checked="" type="checkbox"/> Farm Bureau – Brea Mohamed	<input checked="" type="checkbox"/> IC Fire/OES Office – Robert Malek/Andrew Loper
<input checked="" type="checkbox"/> Public Works – John Gay/Carlos Yee	<input checked="" type="checkbox"/> CARWQCB – Nadim-Shukry Zeywar	<input checked="" type="checkbox"/> IC Sheriff's Office – Robert Benavidez/Thomas Garcia
<input checked="" type="checkbox"/> Brawley Union High School District – Simon Canales	<input checked="" type="checkbox"/> Certified Unified Program Agency (CUPA) – Robert Krug	<input checked="" type="checkbox"/> EHS Office – Vanessa R. Martinez / Jorge Perez
<input checked="" type="checkbox"/> City of Brawley – Rosanna Bayon-Moore	<input checked="" type="checkbox"/> IID Energy Dept. Donald Vargas	<input checked="" type="checkbox"/> Needles Public Utility Dept. – Cindy Commairel
<input checked="" type="checkbox"/> Dept. of Fish & Wildlife Habitat Conservation Cannabls Program – Kim Freebun Marquez	<input checked="" type="checkbox"/> BLM – Carrie Sahagun	<input checked="" type="checkbox"/> Border Patrol Air Oper- Office of Air & Marine
<input checked="" type="checkbox"/> Dept. of Parks & Recreation – Leslie Hartzell	<input checked="" type="checkbox"/> Border Patrol Manager – Nubia L. Bestidas (Avalos)	<input checked="" type="checkbox"/> Border Patrol Manager – Dirk J. Saar

From: Case Planner: Patricia Valenzuela, Planner IV - (442) 265-1736 extension 1749 or via-email at ICPDSComentLetters@co.imperial.ca.us

Project ID: Conditional Use Permit #20-0015

Project Location: The project is located at 2496 East Highway 78, Brawley, CA. 92227. APN 039-120-027-000 also described as Section 33, Township 13 South, Range 16 East, SB&MM.

Project Description: Client's intent is to install an onsite RV wastewater treatment system.

Applicant: Kyle Vestermark, 70 Hollyleap, Aliso Viejo, CA 92656

Comments due by: November 4, 2020

PC/EEC Meeting: TBD

MSS\IAI\user\AFM\039120027\CUP20-0015\Request for Comments 10 20 2020.docx

"No COMMENT"

*Margo Sanchez Deputy Ag Commissioner/ Secler 11/2/2020 X1495
margo.sanchez@co.imperial.ca.us*

Kimberly Noriega

From: Margo Sanchez
Sent: Wednesday, November 4, 2020 4:06 PM
To: ICPDSCommentLetters; Patricia Valenzuela
Cc: Jolene Dessert
Subject: CUP20-0015 Dunes Edge-K.Vestermark-No Comment
Attachments: 0835_001.pdf

Hi Patricia,

I have attached a file for No Comment from the Agricultural Commissioner's office for this project.

Please let me know if you need any additional information.

Best regards,

Margo



Margo E. Sanchez
Deputy Agricultural Commissioner/Sealer
Imperial County
AgCom.ImperialCounty.org/
442.265.1500

EEC ORIGINAL PKG

CONDITIONAL USE PERMIT

I.C. PLANNING & DEVELOPMENT SERVICES DEPT.
801 Main Street, El Centro, CA 92243 (760) 482-4236

- APPLICANT MUST COMPLETE ALL NUMBERED (black) SPACES - Please type or print -

1. PROPERTY OWNER'S NAME <u>Kyle Vestermark</u>	EMAIL ADDRESS <u>Kyle@dunesedgestorage.com</u>	
2. MAILING ADDRESS (Street / P O Box, City, State) <u>70 Hollyleaf Aliso Viejo CA 92656</u>	ZIP CODE <u>92656</u>	PHONE NUMBER <u>714-396-3611</u>
3. APPLICANT'S NAME <u>Kyle Vestermark</u>	EMAIL ADDRESS <u>Same</u>	
4. MAILING ADDRESS (Street / P O Box, City, State) <u>same</u>	ZIP CODE <u>same</u>	PHONE NUMBER <u>same</u>
4. ENGINEER'S NAME <u>Kyle Vestermark</u>	CA. LICENSE NO. <u>M29538</u>	EMAIL ADDRESS <u>same</u>
5. MAILING ADDRESS (Street / P O Box, City, State)	ZIP CODE	PHONE NUMBER <u>same</u>
6. ASSESSOR'S PARCEL NO. <u>039-120-027</u>	SIZE OF PROPERTY (in acres or square foot) <u>13 acres</u>	ZONING (existing) <u>CZ or SF</u>
7. PROPERTY (site) ADDRESS <u>2496 E Hwy 78 Browley CA 92277</u>		
8. GENERAL LOCATION (i.e. city, town, cross street) <u>Hwy 78 + Green Rd</u>		
9. LEGAL DESCRIPTION <u>Section 33 Township 13 South, Range 16 East, San Bernardino Meridian</u>		

PLEASE PROVIDE CLEAR & CONCISE INFORMATION (ATTACH SEPARATE SHEET IF NEEDED)

10. DESCRIBE PROPOSED USE OF PROPERTY (list and describe in detail)	<u>Install onsite RV wastewater treatment system</u>
11. DESCRIBE CURRENT USE OF PROPERTY	<u>RV storage</u>
12. DESCRIBE PROPOSED SEWER SYSTEM	<u>Facultative or Constructed wetlands</u>
13. DESCRIBE PROPOSED WATER SYSTEM	<u>NA</u>
14. DESCRIBE PROPOSED FIRE PROTECTION SYSTEM	<u>na</u>
15. IS PROPOSED USE A BUSINESS? <input checked="" type="checkbox"/> Yes <input type="checkbox"/> No	IF YES, HOW MANY EMPLOYEES WILL BE AT THIS SITE? <u>0</u>

I / WE THE LEGAL OWNER (S) OF THE ABOVE PROPERTY CERTIFY THAT THE INFORMATION SHOWN OR STATED HEREIN IS TRUE AND CORRECT.

Kyle Vestermark 8/11/2020
Print Name Date
Kyle Vestermark
Signature

Print Name Date

Signature

REQUIRED SUPPORT DOCUMENTS

A. SITE PLAN	_____
B. FEE	_____
C. OTHER	_____
D. OTHER	_____

APPLICATION RECEIVED BY:	<u>Jeanne R. (Mail)</u>	DATE	<u>8/14/2020</u>	REVIEW / APPROVAL BY OTHER DEPT'S required.
APPLICATION DEEMED COMPLETE BY:	_____	DATE	_____	<input type="checkbox"/> P. W.
APPLICATION REJECTED BY:	_____	DATE	_____	<input type="checkbox"/> E. H. S.
TENTATIVE HEARING BY:	_____	DATE	_____	<input type="checkbox"/> A. P. C. D.
FINAL ACTION:	<input type="checkbox"/> APPROVED <input type="checkbox"/> DENIED	DATE	_____	<input type="checkbox"/> O. E. S.
		DATE	_____	<input type="checkbox"/> _____
		DATE	_____	<input type="checkbox"/> _____

CUP #

Dunes Edge Storage

Wastewater Treatment System - Project Description

Contact Information

Company: Dunes Edge Storage, LLC
Address: 2496 E Hwy 78, Brawley CA 92227
APN: 039-120-027
Owner: Kyle Vestermark 714-396-3611
Mailing Address: 70 Hollyleaf Ave, Aliso Viejo CA 92656

Project Basis

Dunes Edge Storage (DES) is an RV storage. The purpose of this project is to install an onsite wastewater treatment system (OWTS) to treat the effluent from the RV dump holding tank. This will eliminate all but 2 of the 28 pump outs that occurred in 2019, thereby reducing the environmental impact of those semi-truck trips.

Project Intent

DES is applying for a waste discharge permit with the State of California Regional Water Quality Control Board (RWQCB) for the installation of a OWTS.

Effluent Data

Effluent Discharge period is (6) months: Nov 1st to May 1st.
Design effluent flowrate (max) = 1500 gal/day
Typical effluent flowrate = 750 – 1000 gal/day
Raw effluent values (prior to treatment) (mg/L)
BOD5: 380
TSS: 210
TKN: 270
Ammonia: 190
Phosphorous: 29

These values are expected to decrease by up to 25% with the new OWTS due to the storage customers being able to flush their tanks and hoses with water when they are finished dumping.

Facility Description

The Facility (Dunes Edge Storage) is located at 2496 E Hwy 78, Brawley, CA 92227 and approximately 10 miles east of the Brawley city limits, at the intersection of State Route 78 and Green Rd in Imperial County (**ATTACHMENT 1**). The Facility is an RV storage company that supports the Imperial Sand Dunes recreation community. The Discharger currently utilizes a 3rd party company to pump out the RV effluent from the on-site 10,000 gallon holding tank.

The Assessor's Parcel Number is 039-120-027. The Township and Range are a portion of Section 33, Township 13 South, Range 16 East, San Bernardino Meridian. The Latitude is 32.975442 and the Longitude is -115.324353.

The Discharger plans to expand the existing system with a 5 stage onsite wastewater treatment system. The new system will be capable of treating a maximum of 1,500 gallons per day (gpd) of domestic wastewater generated by the RV's (**ATTACHMENT 2**). The Facility is located in a remote area with no access to municipal water or wastewater systems. The property is relatively flat and is in an area of minimal flood hazard, Zone X, and not subject to a 100-year flood event, as defined by FEMA.

OWTS Description

The proposed OWTS will consist of the following components (**ATTACHMENT 3**):

1. A new Primary 10,000 gallon Holding tank. This tank will have an internal partition to facilitate the removal of primary solids. The effluent leaving this tank will gravity drain to an existing 10,000 gallon Holding tank.
2. The Secondary existing 10,000 gallon Holding tank will also have an internal partition for primary solids removal and will act as a "wide" spot in the line in order to regulate the average daily flow rate. A pump will be installed to empty the 2nd chamber of the tank during the week prior to the (5) known "high RV dump" weekends. This tank will gravity feed into the new 500 gallon Pump tank
3. A new 500 gallon float operated pump tank will discharge the effluent from the Secondary 10,000 gallon holding tank to the Facultative Pond.
4. The Facultative pond will have a trickle filter, a pond divider to enhance the nitrification / de-nitrification process, a liner to eliminate any seepage, and greater than 12" of freeboard. It will have dimensions of 30' wide x 78' long x 5-6" deep and surface area of 2,340. The pond will have a total volume of 75,000 gallons per the "Gloyna Method" calculation. The Facultative pond will gravity feed to a Constructed Wetlands (CW) pond.
5. The CW pond will be a Free Water Surface (FWS) design, will be lined and will have a nitrogen filtration bed (NFB). It will have dimensions of 15' wide x 50' long with a varying depth of 18" to 24" and a surface area of 750 feet. It will have aquatic plants, greater than 12" of freeboard and will gravity drain to a new Subsurface Wastewater Infiltration System (SWIS) leach field.
6. The SWIS will be constructed with high capacity Infiltrator chambers in (3) rows with lengths of 56'.

The Water Balance calculation performed shows that the size of the Facultative pond is sufficient to accommodate a daily loading of 1,500 gpd. Sludge and solid waste from the treatment facility will be periodically hauled away. Further, the calculations do not include the evaporation rate of 375 gallons per day which provides a safety factor greater than 20% on a volume basis.

Best Management Practices (BMPs)

DES will continue with our current General BMP's which include site cleanliness, preventative maintenance, security, daily inspections, facility improvement and record keeping.

OWTS specific BMP's will be implemented starting with the design/engineering of the system and it's various components to ensure simple failsafe operation and continue with the following:

1. Daily inspection of the OWTS.
2. Verifying the integrity of the ponds and pumping / piping components.
3. Removing any vegetation debris and or trash from the ponds.
4. Minimizing objectionable odors, weeds and algae growth.

5. Mosquito breeding prevention.
6. Scheduling pump outs of the (2) holding tanks primary compartments to remove the contained TSS.
7. Testing of the effluent to ensure that the system is operating within the established parameters. And modify the system as necessary if the test results reveal any deficiencies.

Additionally, DES will periodically assess and reevaluate our OWTS components and BMP plan to ensure that we are operating in the safest possible manner.

Technical Data

The Facultative pond design is based on calculations using the "Gloyna Method". Additional calculations were performed to validate the design based on Organic Loading, Hydraulic Loading, and evaporation. The Constructed Wetlands design was based on several studies including EPA documents EPA/625/R-99/010 and EPA 832-F-00-024.

Anticipated Discharge Chemical Compositions

Chemical Constituents	Monthly chemical concentrations tested at process discharge (anticipated)				
	Primary Holding Tank	Secondary Holding Tank	Facultative Pond	Constructed Wetlands	Leach Field
TKN (mg/L)	270	230	10	5	3
BOD (mg/L)	380	323	30	15	10
TSS (mg/L)	210	168	30	15	10

Submitted and signed by Kyle Vestermark, P.E., 6/15/2020



Colorado River Basin Regional Water Quality Control Board

January 5, 2020

Kyle Vestermark, P.E.
Dunes Edge Storage, LLC.
70 Hollyleaf Ave
Aliso Viejo, CA 92656

**SUBJECT: NOTICE OF APPLICABILITY FOR ENROLLMENT IN GENERAL
ORDER NO. 97-500(182)**

**FACILITY: DUNES EDGE STORAGE, LLC. WASTEWATER TREATMENT PLANT,
BRAWLEY, IMPERIAL COUNTY**

Dear Mr. Vestermark:

The California Regional Water Board Quality Control Board, Colorado River Basin Region (Regional Water Board) has reviewed the Report of Waste Discharge (ROWD) and Engineering Report dated March 23, 2020, and the revised ROWD dated August 18, 2020, submitted by Kyle Vestermark, (Discharger) for Dunes Edge Storage Wastewater Treatment Plant (WWTP or Facility).

This letter serves as a Notice of Applicability (NOA) to enroll the Facility in General Order No. 97-500(182), *General Waste Discharge Requirements For On-Site Subsurface Wastewater Disposal Systems For Mobile Home And Recreational Vehicle Parks And Other Similar Facilities* (General Order). The Facility is assigned Waste Discharger Identification (WDID) 7A131011001, and GeoTracker Global ID XXXXXXXXXXXXXXXX.

A copy of the General Order is available online at:

https://www.waterboards.ca.gov/coloradoriver/board_decisions/adopted_orders/orders/1997/97_500small_domestic_gen_order.pdf

You must familiarize yourself with the contents of the General Order. You must manage the discharge in accordance with the requirements contained in the General Order, the information submitted in the ROWD and supplemental correspondence, the requirements contained in this revised NOA, and the requirements of Monitoring and Reporting Program (MRP) 97-500(182).

FACILITY AND DISCHARGE DESCRIPTION

The Facility is located at 2496 E Hwy 78 Brawley, CA 92227, approximately 10 miles east of the Brawley city limits, at the intersection of State Route 78 and Green Rd in Imperial County (see **Attachment 1**). The Facility is owned and operated solely by Kyle Vestermark as an RV storage company that supports the Imperial Sand Dunes recreation community. The Discharger currently utilizes a 3rd party company to pump out the RV effluent from the on-site 10,000 gallon holding tank. The Assessor's Parcel Number is 039-120-27, 28 & 30. The Township and Range are a portion of Section 33, Township 13 South, Range 16 East, San Bernardino Meridian. The Latitude is 32°58'33.2" N and the Longitude is 115°19'26.1" W.

The current septic storage system is inadequate to support the growing Imperial Sand Dunes recreation community that utilizes the Facility. The Discharger plans to expand the current 10,000-gallon holding tank (Primary Tank) to a 5-stage onsite wastewater treatment system (OWTS). This tank also has an internal partition to facilitate the removal of primary solids. The new system will be capable of treating 1,500 gallons per day (gpd) of primarily domestic wastewater generated by RV's. **The system will be installed at the existing RV storage facility (Attachment 1).** The Facility is located in a remote area with no access to municipal water or wastewater systems. The property is relatively flat and is in an area of minimal flood hazard, Zone X, and not subject to a 100-year flood event, as defined by FEMA.

The expansion to the OWTS will include **a new 10,000-gallon (Primary) holding tank with an internal partition that will receive effluent from the (4) existing dump stations that will drain, by gravity, to the existing 10,000-gallon (Secondary) Tank.**

The existing Secondary Tank also has an internal partition for solids removal similar to the Primary Tank. The addition of the Secondary Tank will better allow the Discharger to maintain compliance with the daily limit by providing more space for periods of high traffic at the Facility. A pump will be installed to empty the 2nd chamber of the tank during the weeks prior to the (5) known "high RV dump" weekends. As needed, but at a severely reduced rate. Sludge and solid waste from the treatment facility will be periodically hauled away. **The pump in the Secondary Tank will feed into the 75,000-gallon Facultative pond.**

The Facultative pond will have a: trickle filter to maintain flow rates, pond divider to enhance the nitrification / de-nitrification process, and liner to eliminate any seepage. The Facultative Pond will have dimensions of approximately **32' wide x 62' long x 5.5' deep, with a surface area of 1,984'**. This includes 2 feet of freeboard and a **20%** safety factor (using the "Gloyna Method" calculation). The Facultative pond will also drain, by gravity, to a Constructed Wetlands (CW) Pond. The CW Pond will have a: Free Water Surface (FWS) design, liner, and will have a nitrogen filtration bed (NFB). The CW Pond will be approximately **24' wide x 32' long** with a varying depth of 18" to 24", with a surface area of **768'**. It will also have aquatic plants to further facilitate the treatment of the effluent. The CW pond will drain, by gravity, to a new Subsurface Wastewater

Infiltration System (SWIS) or leach field. The SWIS will be constructed with four high-capacity Infiltrator trenches with lengths of 50'. Vegetation will be planted around the SWIS to further facilitate the treatment of the effluent.

REGULATORY CONSIDERATIONS

With respect to groundwater quality objectives, the Water Quality Control Plan for the Colorado River Basin Region (Basin Plan) states that the Regional Water Board's goal is to maintain the existing water quality of all non-degraded groundwater basins. However, in most cases ground water pumped generally returns to the basin after use with an increase in mineral concentrations, such as total dissolved solids (TDS), nitrates, etc. Under these circumstances, the Regional Water Board's objective is to minimize the quantities of contaminants reaching any groundwater basin. Groundwater in the area of the discharge has a municipal (MUN) beneficial use designation. The Basin Plan further states that ground waters designated for use as domestic or municipal supply shall not contain concentrations of chemical constituents in excess of the limits specified in California Code of Regulations, title 22, chapter 15, article 4, section 64435, Tables 2, 3, and 4 as a result of human activity. While it is anticipated that some degradation of groundwater quality may occur due to the discharge, the increase in the concentrations of the constituents of concern is not expected to be significant. In addition, due to the low volume of the discharge, water quality objectives will not be violated.

CEQA EXEMPTION

The Regional Water Board has determined that the activities authorized by this NOA are exempt from review under the California Environmental Quality Act (CEQA) pursuant to California Code of Regulations, title 14, section 15061. Specifically, the activities authorized by this NOA meet the exemption criteria under California Code of Regulations, title 14, section 15301 (Existing Facilities), section 15302 (Replacement or Reconstruction), section 15303 (New Construction or Conversion of Small Facilities), and/or section 15311 (Accessory Structures). There is already an existing septic storage tank, which the Discharger plans on expanding with a new Secondary Tank, Facultative Pond, Constructed Wetlands Pond, and Subsurface Leachfield. There is no substantial evidence that any exceptions to the foregoing CEQA categorical exemptions apply. Additionally, the State Water Resource Control Board (State Water Board) considered the potential environmental impacts associated with new or expanding small domestic systems enrolled in the General Order in a Negative Declaration adopted on September 23, 2014 through State Water Board Resolution 2014-0054.

SITE SPECIFIC REQUIREMENTS

The operator of the WWTP shall be familiar with the requirements contained in the General Order, this NOA, and the Monitoring and Reporting Program No. 97-500(182) (MRP).

The General Order contains prohibitions and specifications that apply to all wastewater systems, and specifications that apply only to specific treatment and/or disposal systems.

The Discharger shall comply with the following specific requirements:

- a. Required Technical Reports/Plans—90 days after the system is completed, the Discharger shall submit to the Regional Water Board the following plans:
 - The As-Built Construction and Operation Details of the subsurface system for review within 90 days after system completion, consistent with the requirements of General Order Provision C.1;

MONITORING AND REPORTING

The Discharger shall comply with Monitoring and Reporting Program No. 97-500(182). The MRP is effective upon issuance of this NOA. The MRP requires the Discharger to monitor the OWTS, collect and analyze samples according to the following schedule, and report results quarterly and annually. Annual monitoring reports shall be submitted to the Regional Board by **January 15** and shall include, at a minimum, the following:

Waste Management Units

One septic tank/seepage pit or leach field disposal system for every 20 septic tank systems shall be sampled annually during November. The samples shall be analyzed for the following:

<u>Constituent</u>	<u>Units</u>	<u>Sample Type</u>	<u>Sample Frequency</u>	<u>Reporting Frequency</u>
Total Dissolved Solids	mg/L	Grab	Annually	Annually
Phenol Volatile Organics (EPA Methods) 601 and 602)	µg/L	Grab	Annually	Annually
Hydrogen Ion	pH units	Grab	Annually	Annually
Nitrate as NO ₃ -N	mg/L	Grab	Annually	Annually
Total Nitrogen	mg/L	Grab	Annually	Annually

mg/L denotes milligrams per liter.
µg/L denotes milligrams per liter.

Maintenance and Inspection

Septic tanks shall be inspected and pumped as described below:

<u>Parameter</u>	<u>Units</u>	<u>Sample Type</u>	<u>Minimum Inspection Frequency</u>	<u>Reporting Frequency</u>
Sludge depth and scum thickness in each compartment of each septic tank	feet	Staff Gauge	Annually	Annually
Distance between bottom of scum layer and bottom of outlet device	inches	Staff Gauge	Annually	Annually
Distance between top of sludge layer and bottom of outlet device	inches	Staff Gauge	Annually	Annually

Septic tanks shall be pumped when any one of the following conditions exist or may occur before the next inspection:

- a. The combined thickness of sludge and scum exceeds one-third of the tank depth of the first compartment; or,
- b. The scum layer is within three inches of the outlet device; or,
- c. The sludge layer is within eight inches of the outlet device.

In lieu of septic tank measuring, the septic tank may be pumped annually.

WATER CODE SECTION 13267 ORDER FOR TECHNICAL REPORTS

In order to ensure compliance with the specified design and compliance with the conditions of the General Order, the Discharger is hereby directed pursuant to section 13267 of the California Water Code to submit the information described below.

1. **Within 60-days** of issuance of this NOA, the Discharger shall submit a schedule for construction of the onsite wastewater treatment and disposal system.
2. **No later than 3 days** prior to the start of construction of the onsite wastewater treatment and disposal system, the Discharger shall submit copies of all local permits obtained for that purpose, and notify the Regional Water Board verbally and via email for the purpose of establishing appointments for inspections.
3. **Within 30-days** of project completion, the Discharger shall submit a copy of the contract with the operator contracted for the maintenance and operation of the

WWTF. The documentation shall include the detail necessary to demonstrate compliance to the General Order, including solids management and cite contact information and required operator certification.

- 4 **Within 6 months** of project completion, the Discharger shall submit as-built documents depicting the wastewater treatment and disposal **Facultative** pond.
- 5 **Within 3 months** prior to changes to the character of the wastewater or method or location of treated and disposal from that described in the ROWD, the Discharger must submit a new ROWD, or notification that the facility is connecting to a centralized sewer system.
- 6 **The Discharger shall pay** the required annual fee specified in the annual billing from the State Water Board until this NOA is officially terminated. The Discharger must notify the Regional Water Board in writing if the discharge regulated by this NOA ceases so that we may terminate coverage and avoid unnecessary billing.

In accordance with California Business and Professions Code Sections 6735, 7835, and 7835.1, engineering and geologic evaluations and judgments shall be performed by or under the direction of California registered professionals (i.e., civil engineer, engineering geologist, geologist, etc.) competent and proficient in the fields pertinent to the required activities. All technical reports that contain work plans, describe the conduct of investigations and studies, or that contain technical conclusions and recommendations concerning engineering and geology shall be prepared by or under the direction of appropriately qualified professional(s), even if not explicitly stated. The report must contain a statement of qualifications of the licensed professional(s) in responsible charge of this report, as well as the professional's signature and stamp.

All technical reports shall include a statement by the Discharger, or an authorized representative of the Discharger, certifying under penalty of perjury under the laws of the state of California, that the reports were prepared under his or her supervision in accordance with a system designed to assure that qualified personnel properly gather and evaluated the information submitted, and that based on his or her inquiry of the person or persons who manage the system, the information submitted is, to the best of his or her knowledge and belief, true, complete, and accurate.

OTHER REQUIREMENTS

Please review this NOA carefully to ensure that it completely and accurately reflects the proposed discharge. If the discharge violates the terms or conditions of the General Order or this NOA, the Regional Water Board may take enforcement action, including assessment of administrative civil liability of up to \$1,000 per day for late or inadequate reports. If the method or location of treated domestic wastewater disposal changes from that described in the ROWD, you must submit a new ROWD or Notice of Intent (NOI) to comply with the conditions of General Order No. 97-500(182).

Documents that are normally sent via mail by the Discharger, such as regulatory reports, documents, submissions, materials, data, and correspondence, to the Regional Water Board shall be converted to Portable Document Format (PDF) or other appropriate Microsoft application, such as Excel, and submit to the State Water Board GeoTracker database found at: <https://geotracker.waterboards.ca.gov/>. Documents that are too large (400 MB or larger) should be broken down into smaller electronic files, labelled properly and uploaded into GeoTracker. In the subject line, when submitting monitoring reports and documents, please reference General Order No. 97-500(182).

Should you have any questions concerning this NOA, please contact Zakary Owens, Engineering Geologist, at (760) 776-8962, zakary.owens@waterboard.ca.gov or Jose Cortez, Land Disposal Unit Chief, at (760) 776-8963 or at jose.cortez@waterboards.ca.gov.

Sincerely,

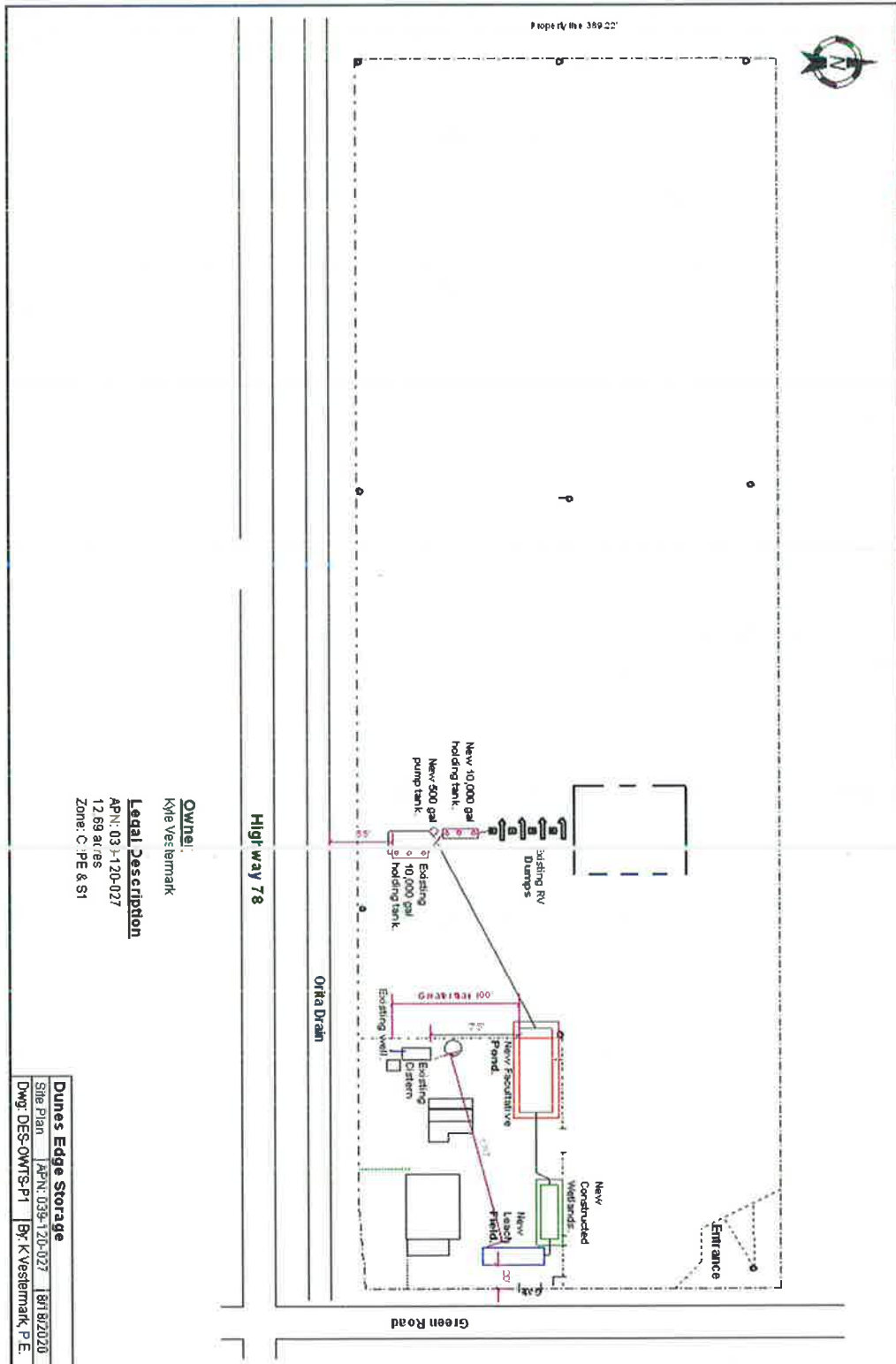
Paula Rasmussen
Executive Officer
Colorado River Basin
Regional Water Quality Control Board

ZO/

Enclosures: General Order No. 97-500(182)

File: 7A131011001, Dunes Edge Storage WWTP, General Order No. 97-500(182)

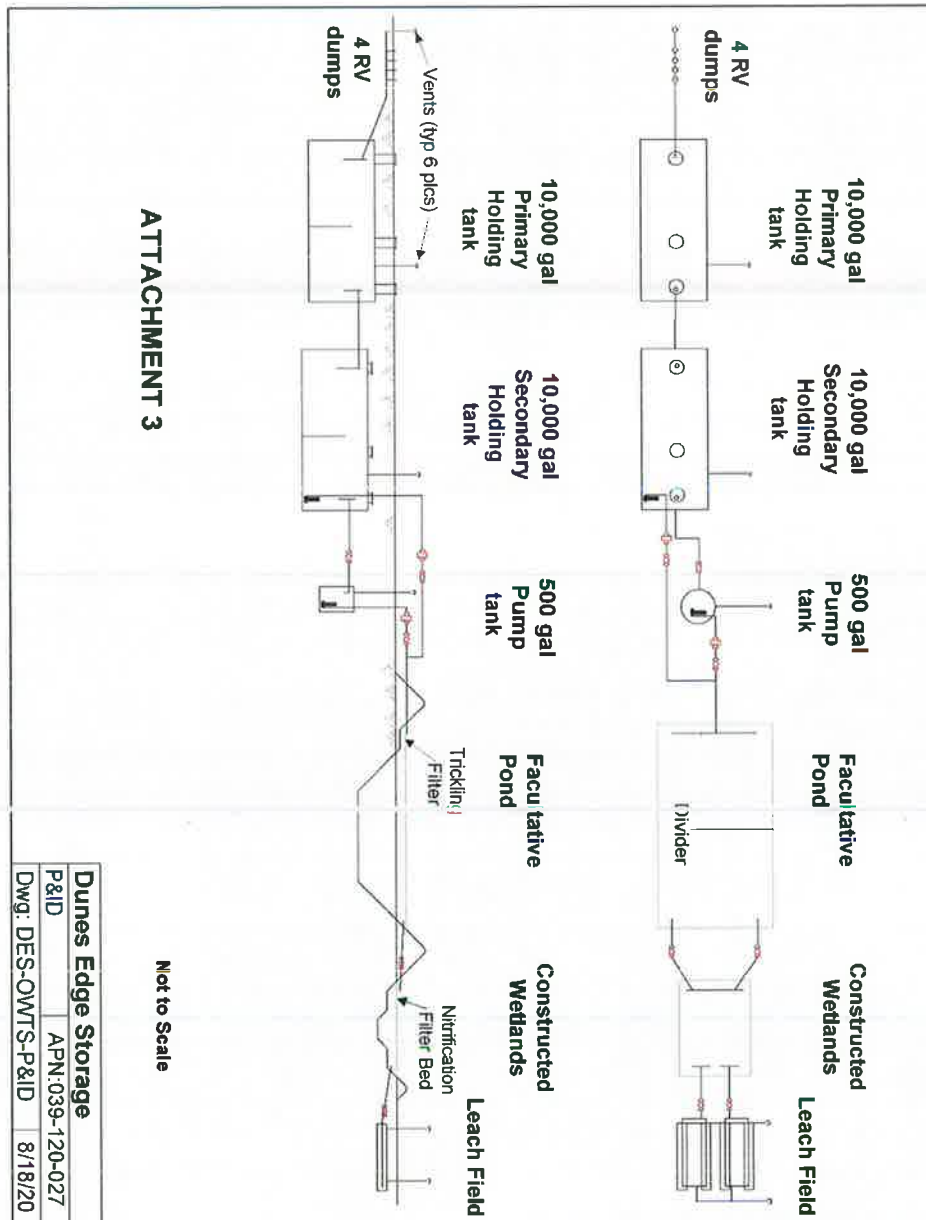
Attachment 1: Site Map



Attachment 2: Vicinity Map



Attachment 3: Wastewater Treatment Plant Process

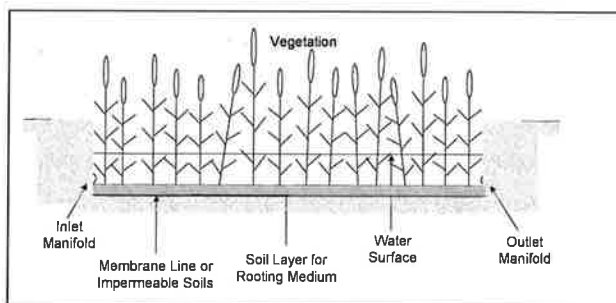




Wastewater Technology Fact Sheet Free Water Surface Wetlands

DESCRIPTION

Free water surface (FWS) wetlands are defined as wetland systems where the water surface is exposed to the atmosphere. Most natural wetlands are FWS systems, including bogs (primary vegetation mosses), swamps (primary vegetation trees), and marshes (primary vegetation grasses and emergent macrophytes.) The observation of water quality improvements in these natural wetlands for many years led to the development of constructed wetlands in an effort to replicate the water quality and habitat benefits of natural wetlands in a constructed ecosystem. The majority of FWS constructed wetlands designed for wastewater treatment are marshes, but a few operating examples of bogs and swamps exist. In FWS treatment wetlands, water flows over a vegetated soil surface from an inlet point to an outlet point. In some cases, water is completely lost to evapotranspiration and seepage within the wetland. A diagram of FWS wetland is shown in Figure 1.



Source: Adapted from drawing by S.C. Reed, 2000.

**FIGURE 1 FREE WATER SURFACE
WETLAND**

There are relatively few examples of the use of natural wetlands for wastewater treatment in the United States. Because any discharge to a natural wetland must satisfy National Pollutant Discharge Elimination System (NPDES) limits, these wetlands are typically used for advanced wastewater treatment (AWT) or tertiary polishing. The design goals for constructed wetlands range from an exclusive commitment for basic treatment functions to systems which provide advanced treatment and/or combine with enhanced wildlife habitat and public recreational opportunities. The size of the FWS wetland systems ranges from small on-site units designed to treat septic tank effluents to large units with more than 16,188 hectares (40,000 acres). A large system is being used to treat phosphorus from agricultural storm water drainage in south Florida. Operational FWS wetlands designed for municipal wastewater treatment in the United States range from less than 3785 liters per day (1,000 gallons per day) to more than 75,708 m³/day (20 million gallons per day).

Constructed FWS wetlands typically consist of one or more shallow basins or channels with a barrier to prevent seepage to sensitive ground waters and a submerged soil layer to support the roots of the selected emergent macrophyte vegetation. Each system has appropriate inlet and outlet structures to ensure uniform distribution and collection of the applied wastewater. The most commonly used emergent vegetations in constructed FWS wetlands include cattail (*Typha* spp.), bulrush (*Scirpus* spp.), and reeds (*Phragmites* spp.). In systems designed primarily for treatment, it is common to select only one or two species for planting. The plant canopy formed by the emergent vegetation shades the water surface, preventing growth and persistence of algae, and reduces wind-induced turbulence in the water

flowing through the system. Perhaps most important are the submerged portions of the living plants, the standing dead plants, and the litter accumulated from previous growth. These submerged surfaces provide the physical substrate for the periphytic-attached growth organisms responsible for much of the biological treatment in the system. The water depth in the vegetated portions of these systems ranges from a few inches to two feet or more.

The influent to these wetlands spreads over a large area of shallow water and emergent vegetation. The subsequent low velocity and essentially laminar flow provides for very effective particulate removal in the front part of the system. This particulate material, characterized as total suspended solids (TSS), contains Biochemical Oxygen Demand (BOD) components, fixed forms of total nitrogen (TN) and total phosphorus (TP), and trace levels of metals and more complex organics. The oxidation or reduction of these particulates releases soluble forms of BOD, TN, and TP to the wetland environment, which are available for adsorption by the soils and removal by the active microbial and plant populations throughout the wetland. Oxygen is available at the water surface, microsites on living plant surfaces, and on root and rhizome surfaces, allowing some aerobic activity the wetland. It is, however, prudent to assume that the bulk of the liquid in the FWS wetland is anoxic or anaerobic. The lack of oxygen can limit the biological removal of ammonia nitrogen ($\text{NH}_3/\text{NH}_4 - \text{N}$) via nitrification, but the FWS wetland is still effective for removal of BOD, TSS, trace metals, and some complex organics because the treatment of these occurs under both aerobic and anoxic conditions.

If nitrogen removal and/or enhancement of wildlife habitat is a project goal, consideration should be given to alternating shallow water emergent vegetated zones with deeper (greater than 1.83 meters or six feet) water zones containing selected submerged vegetation. Deeper water zones provide a completely exposed water surface for atmospheric re-aeration and submerged vegetation provides an additional source of oxygen for nitrification. The deeper water zones will also attract and retain a large variety of wildlife, particularly ducks and other water birds. This concept, in use at Arcata,

California, and Minot, North Dakota, can provide excellent treatment on a year-round basis in warm climates and on a seasonal basis in colder climates where low temperatures and ice formation occur. The hydraulic residence time (HRT) in each of the open water zones should be limited to about three days at design flow to prevent the re-emergence of algae. Such systems should always start and end with shallow emergent vegetation zones to ensure retention and treatment of particulate matter and to minimize wildlife toxicity in the open water zones. The use of FWS constructed wetlands has increased significantly since the late 1980's. The systems are widely distributed in the United States and are found in about 32 states.

Common Modifications

In the United States, it is routine to provide some preliminary treatment prior to a FWS wetland. The minimal acceptable level is the equivalent of primary treatment which can be achieved with septic tanks, with Imhoff tanks for smaller systems, or with deep ponds with a short HRT. About 45 percent of operational FWS wetland systems use facultative lagoons for preliminary treatment, but these systems have also been used behind other treatment systems. For example, some of the largest FWS systems, in Florida and Nevada, were designed for tertiary effluent polishing and receive effluent from mechanical AWT plants.

Non-discharging, total retention FWS systems have been used in arid parts of the United States where the water is completely lost through a combination of seepage and evapotranspiration. These systems require that attention be paid to the long term accumulation of salts and other substances which might become toxic to wildlife or plants in the system. While it is impossible to exclude wildlife from FWS wetlands, it is prudent to minimize their presence until the water quality approaches secondary levels of treatment. This can be accomplished by limiting open water zones to the latter part of the system and using dense stands of emergent vegetation in the front part of the wetland. Selecting vegetation with little food value for animals or birds may also help. In colder climates or where large land areas are not available for wetland removal of nitrogen, a smaller wetland system can

be designed for BOD/TSS removal. Nitrogen removal can be achieved with a separate process. Wetland systems in Kentucky and Louisiana successfully use an integrated gravel trickling filter for nitrification of wastewater ammonia. Seasonally operated FWS wetlands are also used in very cold climates, in which the wastewater is retained in a lagoon during the winter months and discharged to the wetland at a controlled rate during the warm summer months.

APPLICABILITY

FWS wetlands require a relatively large land area, especially if nitrogen or phosphorus removal is required. The treatment is effective and requires little in the way of mechanical equipment, energy, and skilled operator attention. Wetland systems can be a most cost effective treatment alternative where suitable land is available at reasonable cost. They also provide enhanced habitat and recreational values. Land requirements and costs tend to favor application of FWS technology in rural areas.

FWS wetland systems reliably remove BOD, Chemical Oxygen Demand (COD), and TSS. With a sufficiently long HRT, they can also produce low levels of nitrogen and phosphorus. Metals are also removed and a reduction in fecal coliforms of about a one log can be expected. In addition to municipal wastewaters, FWS systems are used to treat mine drainage, urban storm water, combined sewer overflows, agricultural runoff, livestock and poultry wastes, landfill leachates, and for mitigation purposes. Because the water is exposed and accessible to humans and animals, the FWS concept of receiving partially treated wastewater may not be suited for use in individual homes, parks, playgrounds, or similar public facilities. A gravel bed subsurface flow (SF) wetland is a choice for these applications.

ADVANTAGES AND DISADVANTAGES

Some advantages and disadvantages of FWS wetlands are listed below:

Advantages

- FWS wetlands offer effective treatment in a passive manner, minimizing mechanical equipment, energy, and skilled operator requirements.
- FWS wetlands may be less expensive to construct, and are less costly to operate and maintain than conventional mechanical treatment systems.
- Year-round operation for secondary treatment is possible in all but the coldest climates. Year-round operation for advanced or tertiary treatment is possible in warm to moderately temperate climates.
- Wetland systems provide a valuable addition to the "green space" in a community, and include the incorporation of wildlife habitat and public recreational opportunities.
- Wetland systems produce no residual biosolids or sludges requiring subsequent treatment and disposal.
- The removal of BOD, TSS, COD, metals, and persistent organics in municipal wastewaters can be very effective with a reasonable detention time. The removal of nitrogen and phosphorus can also be effective with a significantly longer detention time.

Disadvantages

- The land area required for FWS wetlands can be large, especially if nitrogen or phosphorus removal are required.
- The removal of BOD, COD, and nitrogen are biological processes and essentially continuously renewable. The phosphorus, metals, and some persistent organics removed by the system are bound in the wetland sediments and accumulate over time.

- In cold climates low winter temperatures reduce the rate of removal for BOD and the biological reactions responsible for nitrification and denitrification. An increased detention time can compensate for this, but the increased wetland size required in extremely cold climates may not be cost effective or technically feasible.
- The bulk water in most constructed FWS wetland systems is essentially anoxic, limiting the potential for rapid biological nitrification of ammonia. Increasing the wetland size and, therefore, the detention time, may compensate for this, but may not be cost effective. Alternate methods for nitrification in combination with a FWS wetland have performed successfully.
- Mosquitoes and other insect vectors can be a problem.
- The bird population in a FWS wetland can have adverse impacts if an airport is nearby.
- FWS constructed wetlands can remove fecal coliforms by at least one log from typical municipal wastewaters. This may not be sufficient to meet discharge limits in all locations and supplemental disinfection may be required. The situation is further complicated because birds and other wildlife in the wetland produce fecal coliforms.

DESIGN CRITERIA

Published models for the pollutant removal design of FWS wetland systems have been available since the late 1980's. More recent efforts have produced three textbooks containing design models for FWS wetlands (Reed, et al., 1995; Kadlec & Knight, 1996; Crites & Tchobanoglous, 1998) All three models are based on first order plug flow kinetics but provide different results based on the use of different databases. The Water Environment Federation (WEF) presents a comparison of the three approaches in the Manual of Practice on Natural Systems (WEF, 2000.) Another comparison is found in the U.S. EPA design manual on wetland systems (U.S. EPA, 2000.) This

manual also includes design models developed by Gearheart and Finney. The designer of a FWS wetland system should consult these references and select the method best suited for the project under consideration. A preliminary estimate of the land area required for an FWS wetland can be obtained from Table 1 of typical areal loading rates presented below. These values can also be used to check the results from other references.

The pollutant requiring the largest land area for

TABLE 1 TYPICAL AREAL LOADING RATES

Constituent	Typical Influent Conc. (mg/L)	Target Effluent Conc. (mg/L)	Mass Loading Rate (lb/ac/d)*
Hydraulic Load (in/d)	0.4 - 4**		
BOD	5 - 100	5 - 30	9 - 89
TSS	5 - 100	5 - 30	9 - 100
NH ₃ /NH ₄ as N	2 - 20	1 - 10	1 - 4
NO ₃ as N	2 - 10	1 - 10	2 - 9
TN	2 - 20	1 - 10	2 - 9
TP	1 - 10	0.5 - 3	1 - 4

removal determines the necessary treatment area for the wetland, which is the bottom surface area of the wetland cells. The wastewater flow must be uniformly distributed over the entire surface for that area to be 100 percent effective. This is possible with constructed wetlands by careful grading of the bottom surface and the use of appropriate inlet and outlet structures. Uniform distribution of wastewater is more difficult when natural wetlands are used for treatment or polishing. The existing configuration and topography are typically retained in these natural wetlands, which can result in significant short circuiting of flow. Dye tracer studies in such wetlands have shown that the effective treatment area can be as little as 10 percent of the total wetland area. The total treatment area should be divided into at least two cells for all but the smallest systems. Larger systems should have at

least two parallel trains of cells to provide flexibility for management and maintenance.

Wetland systems are living ecosystems. The life and death cycles of the biota produce residuals which can be measured as BOD, TSS, nitrogen, phosphorus, and fecal coliforms. As a result, regardless of the size of the wetland or the characteristics of the influent, there will always be a residual background concentration of these materials in wetland systems. Table 2 summarizes these background concentrations.

Because removal of BOD and various nitrogen forms is temperature dependent, the temperature of

TABLE 2 "BACKGROUND" FWS WETLAND CONCENTRATIONS

Constituent	Concentration Range
BOD ₅ (mg/L)	1 - 10
TSS (mg/L)	1 - 6
TN (mg/L)	1 - 3
NH ₃ /NH ₄ as N (mg/L)	< 0.1
NO ₃ as N (mg/L)	< 0.1
TP (mg/L)	< 0.2
Fecal Coliforms (MPN/100mL)	50 - 500

the wetland must be known for proper design. The water temperature in large systems with a long HRT (greater than 10 days) will approach the average air temperature except during subfreezing weather in the winter. Methods to estimate the water temperature for wetlands with a shorter HRT (less than 10 days) can be found in the references cited.

Because living plants and litter provide significant frictional resistance to flow through the wetland, it is necessary to consider the hydraulic aspects of system design. Manning's equation is generally accepted as the model for the flow of water through FWS wetlands. Descriptive information is found in the references cited. Flow resistance impacts the configuration selected for the wetland cell: the longer the flow path, the higher the resistance. To

avoid hydraulic problems, an aspect ratio (L:W) of 4:1 or less is recommended.

PERFORMANCE

A lightly loaded FWS wetland can achieve the "background" effluent levels shown in Table 2. In general, an FWS constructed wetland is designed to produce a specified effluent quality. Table 1 can be used to estimate the size of the wetland necessary to produce the desired effluent quality. The design models in the referenced publications provide a more precise estimate of required treatment area. Table 3 summarizes actual performance data for 27 FWS systems from a recent Technology Assessment (U.S. EPA, 2000).

In theory, the performance of a wetland system can be influenced by hydrological factors. High

TABLE 3 SUMMARY OF PERFORMANCE FOR 27 FWS WETLAND SYSTEMS

Constituent	Mean Influent (mg/L)	Mean Effluent (mg/L)
BOD ₅	70	15
TSS	69	15
TKN as N	18	11
NH ₃ /NH ₄ as N	9	7
NO ₃ as N	3	1
TN	12	4
TP	4	2
Dissolved P	3	2
Fecal Coliforms (#/100mL)	73,000	1320

Source: U.S. EPA, 2000.

evapotranspiration (ET) rates may increase effluent concentrations, but may also increase the HRT in the wetland. High precipitation rates dilute the pollutant concentrations but also shorten the HRT in the wetland. In most temperate areas with a moderate climate, these influences are not critical for performance. Hydrological aspects only need to

be considered for extreme values of ET and precipitation.

OPERATION AND MAINTENANCE

The routine operation and maintenance (O&M) requirements for FWS wetlands are similar to those for facultative lagoons. They include hydraulic and water depth control, inlet/outlet structure cleaning, grass mowing on berms, inspection of berm integrity, wetland vegetation management, mosquito and vector control (if necessary), and routine monitoring.

The water depth in the wetland may need adjustment on a seasonal basis or in response to increased resistance from the accumulating plant litter in the wetland channel. Mosquitoes may require control, depending on local conditions and requirements. The mosquito population in the treatment wetland should be no greater than in adjacent natural wetlands.

Vegetation management in FWS wetlands does not include the routine harvest and removal of the harvested material. Plant uptake of pollutants represents a relatively minor pathway, so harvest and removal on a routine basis does not provide a significant treatment benefit. Removal of accumulated litter may become necessary if there are severe restrictions to flow. Generally, this will only occur if the wetland channels have been constructed with very high aspect ratios (L:W > 10:1). Vegetation management may also include wildlife management, depending on the type of vegetation selected for the system. Animals such as nutria and muskrats have been known to consume all emergent vegetation in FWS constructed wetlands.

Routine water quality monitoring is required for all FWS systems with an NPDES permit. The permit specifies the monitoring requirements and frequency of monitoring. Sampling for NPDES monitoring is usually limited to untreated wastewater and the final system effluent. Since the wetland component is usually preceded by some form of preliminary treatment, the routine monitoring program does not document wetland influent characteristics. Periodic samples of the wetland influent should be obtained

and tested for all but the smallest systems to provide the operator with an understanding of wetland performance and a basis for adjustments, if necessary.

COSTS

The major items included in the capital costs for FWS wetlands are similar to those for lagoon systems, including land, site investigation, site clearing, earthwork, liner, rooting media, plants, inlet and outlet structures, fencing, miscellaneous piping, engineering, legal, contingencies, and contractor's overhead and profit. The liner can be the most expensive item. For example, a plastic membrane liner can approach 40 percent of construction costs. In many cases, compaction of the in-situ native soils provides a sufficient barrier for groundwater contamination. Table 4

TABLE 4 CAPITAL AND O&M COSTS FOR 100,000 GAL/D FWS WETLAND

Item	Cost (\$)*	
	Native Soil Liner	Plastic Membrane Liner
Land Cost	16,000	16,000
Site Investigation	3,600	3,600
Site Cleaning	6,600	6,600
Earthwork	33,000	33,000
Liner	0	66,000
Soil Planting Media	10,600	10,600
Plants	5,000	5,000
Planting	6,600	6,600
Inlets/Outlets	16,600	16,600
<i>Subtotal</i>	98,000	164,000
Engineering, legal, etc.	56,800	95,100
<i>Total Capital Cost</i>	154,800	259,100
O&M Costs (\$/year)	6,000	6,000

* June 1999 Costs, ENR CCI = 6039

Source: Water Environment Federation, 2000.

summarizes capital and O&M costs for a hypothetical 378,500 liters per day (100,000 gallon per day) FWS constructed wetland, required to achieve a 2 mg/L ammonia concentration in the effluent. Other calculation assumptions include the following: influent NH₃ = 25 mg/L; water temperature = 20°C (68°F); water depth = 0.46 meters (1.5 ft); porosity = 0.75; treatment area = 1.3 hectares (3.2 ac); and land cost = \$12,355/hectare (\$5,000/ac).

Table 5 compares the life cycle costs for this wetland to the cost of a conventional sequencing batch reactor (SBR) treatment system designed for

TABLE 5 COST COMPARISON FOR FWS WETLAND AND CONVENTIONAL WASTEWATER TREATMENT

Cost Item	Process	
	Wetland	SBR
Capital Cost (\$)	259,000	1,104,500
O&M Cost (\$)	6,000/yr	106,600/yr
Total Present Worth Costs* (\$)	322,700	2,233,400
Cost per 1000 gal treated ** (\$)	0.44	3.06

*Present worth factor 10.594 based on 20 years at 7 percent interest

**Daily flow rate for 365 d/yr for 20 yr, divided by 1000 gal.

Source: Water Environment Federation, 2000.

the same flow and effluent water quality.

REFERENCES

Other Related Fact Sheets

Wetlands: Subsurface Flow
EPA 832-F-00-023
September, 2000

Other EPA Fact Sheets can be found at the following web address:

<http://www.epa.gov/owmitnet/mtbfact.htm>

1. Crites, R.W. and G. Tchobanoglous, 1998, *Small and Decentralized Wastewater Management Systems*, McGraw Hill Co., New York, NY.
2. Kadlec, R.H. and R. Knight, 1996, *Treatment Wetlands*, Lewis Publishers, Boca Raton, FL.
3. Reed, S.C.; R.W. Crites; and E.J. Middlebrooks, 1995, *Natural Systems for Waste Management and Treatment - Second Edition*, McGraw Hill Co, New York, NY.
4. U.S. EPA, 2000, *Free Water Surface Wetlands for Wastewater Treatment: A Technology Assessment*, U.S. EPA, OWM, Washington, D.C.
5. U.S. EPA, 2000, *Design Manual Constructed Wetlands for Municipal Wastewater Treatment*, U.S. EPA, CERL, Cincinnati, OH.
6. Water Environment Federation, 2000, *Natural Systems for Wastewater Treatment*, MOP FD-16, WEF, Alexandria, VA.

ADDITIONAL INFORMATION

Billmayer Engineering
J.J. Billmayer
2191 Third Avenue East
Kalispell, MT 59901

City of Ouray
Carl Cockle
P.O. Box 468
Ouray, CO 81427

Joseph Ernest
Associate Engineer
P.O. Box 5015
Freemont, CA 94537-5015

Humbolt State University
Dept. of Environmental Resource Engineering
Dr. Robert Gearheart
Arcata, CA 95522

Mississippi Gulf Coast Regional Wastewater
Authority
William Rackley
3103 Frederick Street
Pascagoula, MS 39567

The mention of trade names or commercial products
does not constitute endorsement or recommendation
for use by the U.S. Environmental Protection
Agency.

For more information contact:

Municipal Technology Branch
U.S. EPA
Mail Code 4204
1200 Pennsylvania Avenue, NW
Washington, D.C. 20460



EEC ORIGINAL PKG

Patricia Valenzuela

From: Kyle Vestermark <kyle@dunesedgestorage.com>
Sent: Tuesday, March 30, 2021 10:45 AM
To: Monica Soucier; Patricia Valenzuela
Subject: Dunes Edge Storage CUP
Attachments: epa wetlands treatment.pdf; free_water_surface_wetlands.pdf

CAUTION: This email originated outside our organization; please use caution.

Patricia,

Per your request I have attached the (2) documents that were requested by APCD.

If you have any questions, please send me an email or text or give me a call.

Sincerely,
Kyle 714-396-3611

Billing Address:
Dunes Edge Storage
70 Hollyleaf
Aliso Viejo CA 92656

Storage address:
2496 E Hwy 78
Brawley CA 92227

Web: www.dunesedgestorage.com

United States
Environmental Protection
Agency

Office of Research and
Development
Cincinnati, Ohio 45268

EPA/625/R-99/010
September 2000
<http://www.epa.gov/ORD/NRMRL>



Manual

Constructed Wetlands Treatment of Municipal Wastewaters



EEO ORIGINAL PKG

Manual

Constructed Wetlands Treatment of Municipal Wastewaters

National Risk Management Research Laboratory
Office of Research and Development
U.S. Environmental Protection Agency
Cincinnati, Ohio 45268

Notice

This document has been reviewed in accordance with the U.S. Environmental Protection Agency's peer and administrative review policies and approved for publication. Mention of trade names or commercial products does not constitute endorsement or recommendation for use.

Foreword

The U.S. Environmental Protection Agency is charged by Congress with protecting the Nation's land, air, and water resources. Under a mandate of national environmental laws, the Agency strives to formulate and implement actions leading to a compatible balance between human activities and the ability of natural systems to support and nurture life. To meet this mandate, EPA's research program is providing data and technical support for solving environmental problems today and building a science knowledge base necessary to manage our ecological resources wisely, understand how pollutants affect our health, and prevent or reduce environmental risks in the future.

The National Risk Management Research Laboratory is the Agency's center for investigation of technological and management approaches for reducing risks from threats to human health and the environment. The focus of the Laboratory's research program is on methods for the prevention and control of pollution to air, land, water and subsurface resources; protection of water quality in public water systems; remediation of contaminated sites and ground water; and prevention and control of indoor air pollution. The goal of this research effort is to catalyze development and implementation of innovative, cost-effective environmental technologies; develop scientific and engineering information needed by EPA to support regulatory and policy decisions; and provide technical support and information transfer to ensure effective implementation of environmental regulations and strategies.

This publication has been produced as part of the Laboratory's strategic long-term research plan. It is published and made available by EPA's Office of Research and Development to assist the user community and to link researchers with their clients.

E. Timothy Oppelt, Director
National Risk Management Research Laboratory

Abstract

This manual discusses the capabilities of constructed wetlands, a functional design approach, and the management requirements to achieve the designed purpose. The manual also attempts to put the proper perspective on the appropriate use, design and performance of constructed wetlands. For some applications, they are an excellent option because they are low in cost and in maintenance requirements, offer good performance, and provide a natural appearance, if not more beneficial ecological benefits. In other applications, such as large urban areas with large wastewater flows, they may not be at all appropriate owing to their land requirements. Constructed wetlands are especially well suited for wastewater treatment in small communities where inexpensive land is available and skilled operators hard to find and keep.

Primary customers will be engineers who service small communities, state regulators, and planning professionals. Secondary users will be environmental groups and the academics.

Contents

Chapter 1 Introduction	1
1.1. Scope	1
1.2. Terminology	1
1.3. Relationship to Previous EPA Documents	2
1.4. Wetlands Treatment Database	2
1.5. History	4
1.6. Common Misperceptions	4
1.7. When to Use Constructed Wetlands	5
1.8. Use of This Manual	8
1.9. References	8
Chapter 2 Introduction to Constructed Wetlands	10
2.1. Understanding Constructed Wetlands	10
2.2. Ecology of Constructed Wetlands	12
2.3. Botany of Constructed Wetlands	12
2.4. Fauna of Constructed Wetlands	16
2.5. Ecological Concerns for Constructed Wetland Designers	16
2.6. Human Health Concerns	18
2.7. Onsite System Applications	19
2.8. Related Aquatic Treatment Systems	19
2.9. Frequently Asked Questions	20
2.10. Glossary	23
2.11. References	27
Chapter 3 Removal Mechanisms and Modeling Performance of Constructed Wetlands	30
3.1. Introduction	30
3.2. Mechanisms of Suspended Solids Separations and Transformations	30
3.3. Mechanisms for Organic Matter Separations and Transformations	35
3.4. Mechanisms of Nitrogen Separations and Transformations	42
3.5. Mechanisms of Phosphorus Separations and Transformations	46
3.6. Mechanisms of Pathogen Separations and Transformations	48
3.7. Mechanisms of Other Contaminant Separations and Transformations	49
3.8. Constructed Wetland Modeling	50
3.9. References	52
Chapter 4 Free Water Surface Wetlands	55
4.1. Performance Expectations	55
4.2. Wetland Hydrology	64
4.3. Wetland Hydraulics	65
4.4. Wetland System Design and Sizing Rationale	68
4.5. Design	69
4.6. Design Issues	78
4.7. Construction/Civil Engineering Issues	81
4.8. Summary of Design Recommendations	83
4.9. References	83

Contents (cont.)

Chapter 5 Vegetated Submerged Beds	86
5.1 Introduction	86
5.2 Theoretical Considerations	86
5.3 Hydrology	91
5.4 Basis of Design	93
5.5 Design Considerations	101
5.6 Design Example for a VSB Treating Septic Tank or Primary Effluent	103
5.7 On-site Applications	106
5.8 Alternative VSB Systems	106
5.9 References	107
Chapter 6 Construction, Start-Up, Operation, and Maintenance	111
6.1 Introduction	111
6.2 Construction	111
6.3 Start-Up	117
6.4 Operation and Maintenance	118
6.5 Monitoring	119
6.6 References	119
Chapter 7 Capital and Recurring Costs of Constructed Wetlands	120
7.1 Introduction	120
7.2 Construction Costs	120
7.3 Operation and Maintenance Costs	125
7.4 References	127
Chapter 8 Case Studies	128
8.1 Free Water Surface (FWS) Constructed Wetlands	128
8.2 Vegetated Submerged Bed (VSB) Systems	141
8.3 Lessons Learned	152

List of Figures

2-1	Constructed wetlands in wastewater treatment train	11
2-2	Elements of a free water surface (FWS) constructed wetland	11
2-3	Elements of a vegetated submerged bed (VSB) system	11
2-4	Profile of a 3-zone FWS constructed wetland cell	18
3-1	Mechanisms which dominate FWS systems	32
3-2	Weekly transect TSS concentration for Arcata cell 8 pilot receiving oxidation pond effluent	34
3-3	Variation in effluent BOD at the Arcata enhancement marsh	36
3-4	Carbon transformations in an FWS wetland	37
3-5	Dissolved oxygen distribution in emergent and submergent zones of a tertiary FWS	40
3-6	Nitrogen transformations in FWS wetlands	43
3-7	Phosphorus cycling in an FWS wetland	47
3-8	Phosphorus pulsing in pilot cells in Arcata	48
3-9	Influent versus effluent FC for the TADB systems	49
3-10	Adaptive model building	51
4-1	Effluent BOD vs areal loading	57
4-2	Internal release of soluble BOD during treatment	57
4-3	Annual detritus BOD load from Scirpus & Typha	58
4-4	TSS loading vs TSS in effluent	58
4-5	Effluent TKN vs TKN loading	59
4-6	Effluent TP vs TP areal loading	61
4-7	Total phosphorus loading versus effluent concentration for TADB systems	61
4-8	Hydraulic retention time vs orthophosphate removal	62
4-9	Influent versus effluent FC concentration for TADB systems	63
4-10	TSS, BOD and FC removals for Arcata Pilot Cell 8	63
4-11	Tracer response curve for Sacramento Regional Wastewater Treatment Plant Demonstration Wetlands Project Cell 7	67
4-12	Transect BOD data for Arcata Pilot Cell 8	71
4-13	Elements of a free water surface (FWS) constructed wetland	71
4-14	Generic removal of pollutants in a 3-zone FWS system	72
5-1	Seasonal cycle in a VSB	90
5-2	Preferential flow in a VSB	93
5-3	Lithium chloride tracer studies in a VSB system	94
5-4	Effluent TSS vs areal loading rate	95
5-5	Effluent TSS vs volumetric loading rate	95
5-6	Effluent BOD vs areal loading rate	96
5-7	Effluent BOD vs volumetric loading rate	96
5-8	Effluent TKN vs areal loading rate	98
5-9	Effluent TP vs areal loading rate	99
5-10	NADB VSBs treating pond effluent	100
5-11	Proposed Zones in a VSB	102
6-1	Examples of constructed wetland berm construction	112
6-2	Examples of constructed wetland inlet designs	114

List of Figures (cont.)

6-3	Outlet devices	115
8-1	Schematic diagram of wetland system at Arcata, CA	129
8-2	Schematic diagram of Phase 1&2 wetland systems at West Jackson County, MS	132
8-3	Schematic diagram of Phase 3 wetland expansion at West Jackson County, MS	132
8-4	Schematic diagrams of the wetland system at Gustine, CA	136
8-5	Schematic diagram of the wetland system at Ouray, CO	140
8-6	Schematic of Minoa, NY, VSB system	142
8-7	Schematic diagram of typical VSB (one of three) at Mesquite, NV	145
8-8	Schematic of VSB system at Mandeville, LA	147
8-9	Schematic of VSB system at Sorrento, LA	151

List of Tables

1-1. Types of Wetlands in the NADB	3
1-2. Types of Wastewater Treated and Level of Pretreatment for NADB Wetlands	3
1-3. Size Distribution of Wetlands in the NADB	4
1-4. Distribution of Wetlands in the NADB by State/Province	4
1-5. Start Date of Treatment Wetlands in the NADB	4
2-1 Characteristics of Plants for Constructed Wetlands	14
2-2 Factors to Consider in Plant Selection	15
2-3 Characteristics of Animals Found in Constructed Wetlands	16
3-1 Typical Constructed Wetland Influent Wastewater	30
3-2 Size Distributions for Solids in Municipal Wastewater	31
3-3 Size Distribution for Organic and Phosphorus Solids in Municipal Wastewater	31
3-4 Fractional Distribution of BOD, COD, Turbidity and TSS in the Oxidation Pond Effluent and Effluent from Marsh Cell 5	34
3-5 Background Concentrations of Contaminants of Concern in FWS Wetland Treatment System Effluents	35
3-6 Wetland Oxygen Sources and Sinks	41
4-1 Loading and Performance Data for Systems Analyzed in This Document	56
4-2 Trace Metal Concentrations and Removal Rates, Sacramento Regional Wastewater Treatment Plant	63
4-3 Fractional Distribution of BOD, COD and TSS in the Oxidation Pond Effluent and Effluent from Marsh Cell 5	64
4-4 Background Concentrations of Water Quality Constituents of Concern in FWS Constructed Wetlands	70
4-5 Examples of Change in Wetland Volume Due to Deposition of Non-Degradable TSS (V_{SS}) and Plant Detritus (V_p) Based on 100 Percent Emergent Plant Coverage	74
4-6 Lagoon Influent and Effluent Quality Assumptions	77
4-7 Recommended Design Criteria for FWS Constructed Wetlands	83
5-1 Hydraulic Conductivity Values Reported in the Literature	92
5-2 Comparison of VSB Areas Required for BOD Removal Using Common Design Approaches	97
5-3 Data from Las Animas, CO VSB Treating Pond Effluent	100
5-4 Summary of VSB Design Guidance	106
7-1 Cost Comparison of 4,645m ² Free Water Surface Constructed Wetland and Vegetated Submerged Bed	121
7-2 Technical and Cost Data for Wetland Systems Included in 1997 Case Study Visitations	121
7-3 Clearing and Grubbing Costs for EPA Survey Sites	122
7-4 Excavation and Earthwork Costs for EPA Survey Sites	122
7-5 Liner Costs for EPA Survey Sites	123
7-6 Typical Installed Liner Costs for 9,300m ² Minimum Area	123
7-7 Media Costs for VSBs from EPA Survey Sites	124
7-8 Costs for Wetland Vegetation and Planting from EPA Survey Sites	124
7-9 Costs for Inlet and Outlet Structures from EPA Sites	124
7-10 Range of Capital Costs for a 0.4 ha Membrane-Lined VSB and FWS Wetland	126
7-11 Annual O&M Costs at Carville, LA (570m ³ /d) Vegetated Submerged Bed	127
7-12 Annual O&M Costs for Constructed Wetlands, Including All Treatment Costs	127

List of Tables (cont.)

8-1	Summary of Results, Phase 1 Pilot Testing, Arcata, CA	130
8-2	Long-Term Average Performance, Arcata WWTP	131
8-3	Wetland Water Quality, West Jackson County, MS	134
8-4	Performance Results in Mature Vegetated vs Immature Vegetated FWS Cells, Gustine, CA	138
8-5	Wetland Effluent Characteristics, Gustine, CA	139
8-6	BOD & TSS Removal for Ouray, CO	141
8-7	Village of Minoa VSB Construction Costs	143
8-8	Summary Performance, Mesquite, NV, VSB Component	146
8-9	Monthly Effluent Characteristics, Mesquite, NV, VSB Component	146
8-10	Water Quality Performance, Mandeville, LA, Treatment System (June - Sept., 1991)	149
8-11	Water Quality Performance, Mandeville, LA, Treatment System (Jan. 1996 - July 1997)	150
8-12	VSB Effluent Water Quality, Sorrento, LA	152

Acknowledgments

Many people participated in the creation of this manual. Technical direction throughout the multi-year production process was provided by USEPA's National Risk Management Research Laboratory (NRMRL). Technical writing was carried out in several stages, but culminated into a final product as a cooperative effort between the NRMRL and the contractors named below. Significant technical reviews and contributions based on extensive experience with constructed wetlands were made by a number of prominent practitioners. Technical review was provided by a group of professionals with extensive experience with the problems specific to small community wastewater treatment systems. The production of the document was also a joint effort by NRMRL and contractual personnel. All of these people are listed below:

Primary Authors and Oversight Committee

Donald S. Brown, Water Supply and Water Resources Division, NRMRL, Cincinnati, OH
James F. Kreissl, Technology Transfer and Support Division, NRMRL, Cincinnati, OH
Robert A. Gearheart, Humboldt University, Arcata, CA
Andrew P. Kruzic, University of Texas at Arlington, Arlington, TX
William C. Boyle, University of Wisconsin, Madison, WI
Richard J. Otis, Ayres Associates, Madison, WI

Major Contributors/Authors

Sherwood C. Reed, Environmental Engineering Consultants, Norwich, VT
Richard Moen, Ayres Associates, Madison, WI
Robert Knight, Consultant, Gainesville, FL
Dennis George, Tennessee Technological University, Cookeville, TN
Brad Finney, Humboldt University, Arcata, CA
Jeff Anderson, Humboldt University, Arcata, CA
Margaret Lang, Humboldt University, Arcata, CA
Michael Ogden, Southwest Wetlands Group, Inc., Santa Fe, NM
Ronald Crites, Brown and Caldwell, Sacramento, CA
George Tchobanoglous, Consultant, Davis, CA

Contributing Writers/Production Specialists

Ian Clavey, CEP Inc., Cincinnati, OH
Vince Iacobucci, CEP Inc., Cincinnati, OH
Julie Hotchkiss, CEP Inc., Cincinnati, OH
Peggy Heimbrock, TTSD - NRMRL, Cincinnati, OH
Stephen E. Wilson, TTSD - NRMRL, Cincinnati, OH
Denise Ratliff, TTSD - NRMRL, Cincinnati, OH
Betty Kampsen, STD - NRMRL, Cincinnati, OH

Technical Reviewers

Arthur H. Benedict, EES Consulting, Inc., Bellevue, WA
Pio Lombardo, Lombardo Associates, Inc., Newton, MA
Rao Surampalli, USEPA - Region VII, Kansas City, KS
Robert K. Bastian, USEPA - Office of Wastewater Management, Washington, DC

Chapter 1 Introduction to the Manual

1.1. Scope

Constructed wetlands are artificial wastewater treatment systems consisting of shallow (usually less than 1 m deep) ponds or channels which have been planted with aquatic plants, and which rely upon natural microbial, biological, physical and chemical processes to treat wastewater. They typically have impervious clay or synthetic liners, and engineered structures to control the flow direction, liquid detention time and water level. Depending on the type of system, they may or may not contain an inert porous media such as rock, gravel or sand.

Constructed wetlands have been used to treat a variety of wastewaters including urban runoff, municipal, industrial, agricultural and acid mine drainage. However, the scope of this manual is limited to constructed wetlands that are the major unit process in a system to treat municipal wastewater. While some degree of pre- or post- treatment will be required in conjunction with the wetland to treat wastewater to meet stream discharge or reuse requirements, the wetland will be the central treatment component.

This manual discusses the capabilities of constructed wetlands, a functional design approach, and the management requirements to achieve the designed purpose. This manual also attempts to put the proper perspective on the appropriate use of constructed wetlands. For some applications, they are an excellent option because they are low in cost and in maintenance requirements, offer good performance, and provide a natural appearance, if not more beneficial ecological benefits. However, because they require large land areas, 4 to 25 acres per million gallons of flow per day, they are not appropriate for some applications. Constructed wetlands are especially well suited for wastewater treatment in small communities where inexpensive land is available and skilled operators are hard to find.

1.2 Terminology

A brief discussion of terminology will help the reader differentiate between the constructed wetlands discussed in this manual and other types of wetlands. Wetlands are defined in Federal regulations as "those areas that are inundated or saturated by surface or ground water at a frequency and duration sufficient to support, and that under

normal circumstances do support, a prevalence of vegetation typically adapted for life in saturated soil conditions. Wetlands generally include swamps, marshes, bogs and similar areas." (40 CFR 230.3(t)) Artificial wetlands are wetlands that have been built or extensively modified by humans, as opposed to natural wetlands which are existing wetlands that have had little or no modification by humans, such as filling, draining, or altering the flow patterns or physical properties of the wetland. The modification or direct use of natural wetlands for wastewater treatment is discouraged and natural wetlands are not discussed in this manual (see discussion of policy issues in Section 1.7.2).

As previously defined, constructed wetlands are artificial wetlands built to provide wastewater treatment. They are typically constructed with uniform depths and regular shapes near the source of the wastewater and often in upland areas where no wetlands have historically existed. Constructed wetlands are almost always regulated as wastewater treatment facilities and cannot be used for compensatory mitigation (see Section 1.7.2). Some EPA documents refer to constructed wetlands as constructed treatment wetlands to avoid any confusion about their primary use as a wastewater treatment facility (USEPA, 1999). Constructed wetlands which provide advanced treatment to wastewater that has been pretreated to secondary levels, and also provide other benefits such as wildlife habitat, research laboratories, or recreational uses are sometimes called enhancement wetlands.

Constructed wetlands have been classified by the literature and practitioners into two types. Free water surface (FWS) wetlands (also known as surface flow wetlands) closely resemble natural wetlands in appearance because they contain aquatic plants that are rooted in a soil layer on the bottom of the wetland and water flows through the leaves and stems of plants. Vegetated submerged bed (VSB) systems (also known as subsurface flow wetlands) do not resemble natural wetlands because they have no standing water. They contain a bed of media (such as crushed rock, small stones, gravel, sand or soil) which has been planted with aquatic plants. When properly designed and operated, wastewater stays beneath the surface of the media, flows in contact with the roots and rhizomes of the plants, and is not visible or available to wildlife.

The term "vegetated submerged bed" is used in this manual instead of subsurface flow wetland because it is a more accurate and descriptive term. The term has been used previously to describe these units (WPCF, 1990; USEPA, 1994). Some VSBs may meet the strict definition of a wetland, but a VSB does not support aquatic wildlife because the water level stays below the surface of the media, and is not conducive to many of the biological and chemical interactions that occur in the water and sediments of a wetland with an open water column. VSBs have historically been characterized as constructed wetlands in the literature, and so they are included in this manual.

Constructed wetlands should not be confused with created or restored wetlands, which have the primary function of wildlife habitat. In an effort to mimic natural wetlands, the latter often have a combination of features such as varying water depths, open water and dense vegetation zones, vegetation types ranging from submerged aquatic plants to shrubs and trees, nesting islands, and irregular shorelines. They are frequently built in or near places that have historically had wetlands, and are often built as compensatory mitigation. Created and restored wetlands for habitat or compensatory mitigation are not discussed in this manual.

Finally, the term vertical flow wetland is used to describe a typical vertical flow sand or gravel filter which has been planted with aquatic plants. Because successful operation of this type of system depends on its operation as a filter (i.e. frequent dosing and draining cycles), this manual does not discuss this type of system.

1.3 Relationship to Previous EPA Documents

Several Offices or Programs within USEPA have published documents in recent years on the subject of constructed wetlands. Some examples of publications and their USEPA sponsors are:

- Design Manual: Constructed Wetlands and Aquatic Plant Systems for Municipal Wastewater Treatment (1988) (Office of Research and Development, Cincinnati, OH, EPA 625-1-88-022)
- Subsurface Flow Constructed Wetlands for Wastewater Treatment: A Technology Assessment (1993) (Office of Wastewater Management, Washington, DC, EPA 832-R-93-008)
- Habitat Quality Assessment of Wetland Treatment Systems (3 studies in 1992 and 1993) (Environmental Research Lab, Corvallis, OR, EPA 600-R-92-229, EPA 600-R-93-117, EPA 600-R-93-222)
- Constructed Wetlands for Wastewater Treatment and Wildlife Habitat: 17 Case Studies (1993) (Office of Wastewater Management, Washington, DC, EPA 832-R-93-005)
- Guidance for Design and Construction of a Subsurface Flow Constructed Wetland (August 1993) (USEPA Region VI, Municipal Facilities Branch)

- A Handbook of Constructed Wetlands (5 volumes, 1995) (USEPA Region III with USDA, NRCS, ISBN 0-16-052999-9)
- Constructed Wetlands for Animal Waste Treatment: A Manual on Performance, Design, and Operation With Cases Histories (1997) (USEPA Gulf of Mexico Program)
- Free Water Surface Wetlands for Wastewater Treatment: A Technology Assessment (1999) (Office of Wastewater Management, Washington, DC, EPA/832/R-99/002)

Some information presented in this manual may contradict information presented in these other documents. Some contradictions are the result of new information and understanding developed since the publication of earlier documents; some contradictions are the result of earlier misconceptions about the mechanisms at work within constructed wetlands; and some contradictions are the result of differing opinions among experts when insufficient information exists to present a clear answer to issues surrounded by disagreement. As stated previously, this manual attempts to put an environmental engineering perspective on the use, design and performance of constructed wetlands as reflected by the highest quality data available at this time. In areas where there is some disagreement among experts, this manual assumes a conservative approach based on known treatment mechanisms which fit existing valid data.

1.4 Wetlands Treatment Database

Through a series of efforts funded by the USEPA, a Wetlands Treatment Database, "North American Wetlands for Water Quality Treatment Database or NADB" (USEPA, 1994) has been compiled which provides information about natural and constructed wetlands used for wastewater treatment in North America. Version 1 of the NADB was released in 1994 and contains information for treatment wetlands at 174 locations in over 30 US states and Canadian provinces. Information includes general site information, system specific information (e.g., flow, dimensions, plant species), contact people with addresses and phone numbers, literature references, and permit information. It also contains some water quality data (BOD, TSS, N-series, P, DO, and fecal coliforms), but the data is not of uniform quantity and quality, which makes it inappropriate for design or modeling purposes.

Version 2 of the NADB is currently undergoing Agency review and contains information on treatment wetlands at 245 locations in the US and Canada. Because each location may have multiple wetland cells, there are over 800 individual wetland cells identified in Version 2. Besides expanding the number of wetland locations from Version 1, Version 2 also contains information regarding vegetation, wildlife, human use, biomonitoring and additional water quality data. As with Version 1, the data is not adequate for design or modeling.

Data did not exist or were incomplete for many of the wetlands included in the NADB. Only existing information was collected for the NADB; no new measurements were made. Therefore, the NADB is very useful for obtaining general information about the status of constructed wetlands usage, as well as the locations of operating systems and people to contact. However, it is not useful as a source of water quality data for wetland design or prediction of treatment performance.

Tables 1.1 through 1.4 give an overview of Version 2 of the NADB. The size range and median size are shown in

several tables to give the reader a feel for the size of each type of wetland. The median size is shown because there are a few very large wetlands in some of the groups, which makes the median size more characteristic of the group than the mean size.

Tables 1.1 and 1.2 group the wetlands by type of wetland and type of wastewater being treated, respectively. In general FWSs are larger than VSBs, with the median size of FWS wetlands being twice that of VSBs. The summary statistics for "other water" wetlands in Table 1.2 are somewhat misleading because they are influenced by the large Everglades Nutrient Removal project in Florida.

Table 1-1. Types of Wetlands in the NADB

Type of Wetland	Qty.	Min.	Size (hectares) Median	Max.
Constructed Wetlands	205	0.0004	0.8	1406
Free Water Surface	138	0.0004	1	1406
Marsh*	125	0.0004	1	1406
Other	13	0.08	3	188
Vegetated Submerged Bed (all Marsh)	49	0.004	0.5	498
Combined FWS & VSB (all Marsh)	8	0.1	0.4	17
Other or Not Classified	10	0.01	1	14
Natural Wetlands (all Free Water Surface)	38	0.2	40	1093
Forest	18	1	40	204
Marsh	16	0.2	33	1093
Other or Not Classified	4	6	64	494
Not Classified	2			

*Marshes are characterized by soft-stemmed herbaceous plants, including emergent species, such as cattails, floating species, such as water lilies, and submerged species, such as pondweeds. (Niering, 1985)

Table 1-2. Types of Wastewater Treated and Level of Pretreatment for NADB Wetlands

Wastewater Type Pretreatment	Qty.	Min.	Size (hectares) Median	Max.
Agricultural	58	0.0004	0.1	47
None	8			
Primary	35			
Facultative	14			
Not classified	1			
Industrial	13	0.03	10	1093
Primary	1			
Facultative	2			
Secondary	6			
Advanced Secondary	1			
Not classified	3			
Municipal	159	0.004	2	500
Primary	9			
Facultative	78			
Secondary	49			
Advanced Secondary	9			
Tertiary	4			
Other	4			
Not classified	6			
Stormwater	6	0.2	8	42
None	4			
Secondary	1			
Other	1			
Other Water	7	3	376	1406
None	4			
Primary	1			
Facultative	1			
Secondary	1			
Not classified	2			

Table 1.3 groups all the wetlands, regardless of type of wetland or wastewater being treated, by size. In terms of area, the majority of the wetlands are less than 10 hectares (25 acres), and almost 90% are less than 100 hectares (250 acres). In terms of design flow rate, the majority are less than 1000 m³/d (about 0.25 mgd), and 82% are less than 4060 m³/d (1 mgd).

Table 1.4 groups all the wetlands, regardless of type of wetland or wastewater being treated, by location. Treatment wetlands are located in 34 US states and 6 Canadian provinces. The number of wetlands per state is probably more a function of having an advocate for treatment wetlands in the state than climate or some other favorable condition.

Table 1-3. Size Distribution of Wetlands in the NADB

Area (hectares)		Design Flow (m ³ /d)	
Size Range	Cumulative Percentage	Size Range	Cumulative Percentage
less than 1	46	less than 10	19
less than 10	75	less than 100	31
less than 100	93	less than 1000	62
less than 1000	99	less than 10,000	93

Table 1-4. Distribution of Wetlands in the NADB by State/Province

State or Province*	Number of Wetlands	Size (hectares)		
		Min.	Median	Max.
SD	42	0.3	2	134
FL	24	0.2	44.5	1406
AR	21	0.3	0.8	4
KY	10	0.01	0.1	5
LA	15	0.02	0.3	17
MS	11	0.02	0.9	101
CA	9	0.1	14	59
AL	8	0.04	0.2	6
ONT	8	0.02	0.09	0.4
MD	5	0.1	0.2	2
OR	5	0.1	4	36
SC	5	20	36	185
IN	4	0.002	0.12	1
MI	4	5	56.5	110
MO	4	0.04	0.25	37
NY	4	0.03	0.25	2
PA	4	0.01	0.055	0.2
TX	4	0.1	0.2	0.5
AZ	3	2	38	54
GA	3	0.01	0.3	0.4
ND	3	14	17	33
NVS	3	0.1	0.1	0.4
TN	3	0.1	0.2	0.3
WI	3	0.01	6	156
ALB, IA, ME, MN, NC, NM, NV, QUE	2			
CT, IL, MA, NJ, NWT, PEI, VA, WA	1			

*Two-letter abbreviations are states; three-letter abbreviations are provinces.

1.5 History

Kadlec and Knight (1996) give a good historical account of the use of natural and constructed wetlands for wastewater treatment and disposal. As they point out, natural wetlands have probably been used for wastewater disposal for as long as wastewater has been collected, with documented discharges dating back to 1912. Some early constructed wetlands researchers probably began their efforts based on observations of the apparent treatment capacity of natural wetlands. Others saw wastewater as a source of water and nutrients for wetland restoration or creation. Research studies on the use of constructed wetlands for wastewater treatment began in Europe in the 1950's, and in the US in the late 1960's. Research efforts in the US increased throughout the 1970's and 1980's, with significant Federal involvement by the Tennessee Valley Authority (TVA) and the U.S. Department of Agriculture in the late 1980's and early 1990's. USEPA has had a limited role in constructed wetlands research which might explain the dearth of useful, quality-assured data.

Start dates for constructed wetlands in the NADB are shown in Table 1.5, with the start dates for natural wetlands used for treatment included for comparison. The table shows that the use of FWS wetlands and VSBs in North America really began in the early and late 1980's, respectively, and the number continues to increase. No new natural wetland treatment systems have begun since 1990, and at least one-third of the natural wetland treatment systems included in the NADB are no longer operating.

1.6 Common Misconceptions

Many texts and design guidelines for constructed wetlands, in addition to those listed above sponsored by the various offices of USEPA, have been published since USEPA's 1988 design manual (EC/EWPCA (1990); WPCF (1990); Tennessee Valley Authority (1993); USDA (1993); Reed, et al (1995); Kadlec and Knight (1996); Campbell and Ogden (1999)). Also, a number of international conferences have been convened to present the findings of constructed wetlands research from almost every continent (Hammer (1989); Cooper and Findlater (1990); Moshiri

Table 1-5. Start Date of Treatment Wetlands in the NADB

Type	before 1950	1950's & 60's	1970's	'80-'84	'85-'89	1990's (latest*)
Constructed, FWS	1	0	3	8	33	85 ('96)
Constructed, VSB	0	0	0	0	21	31 ('94)
Constructed, hybrid	0	0	0	1	4	6 ('94)
Natural, FWS	4	3	9	5	8	1 ('90)

*Year of last wetland included in database for this type of wetland - other wetlands may have started after this date, but are not in the database.

(1993); IAWQ (1994)(1995) (1997)). However, in spite of the great amount of resources devoted to constructed wetlands, questions and misconceptions remain about their application, design, and performance. This section briefly describes four common misconceptions; further discussion of these items is found in other chapters.

Misconception #1: Wetland design has been well-characterized by published design equations. Constructed wetlands are complex systems in terms of biology, hydraulics and water chemistry. Furthermore, there is a lack of quality data of sufficient detail, both temporally and spatially, on full-scale constructed wetlands. Due to the lack of data, designers have been forced to derive design parameters by aggregating performance data from a variety of wetlands, which leads to uncertainties about the validity of the parameters. Data from wetlands with detailed research studies with rigorous quality control (QC) might be combined with data from wetlands with randomly collected data with little QC. Data from small wetlands with minimal pretreatment might be combined with data from large wetlands used for polishing secondary effluent. Additional problems with constructed wetlands data include: lack of paired influent-effluent samples; grab samples instead of composited samples; lack of reliable flow or detention time information; and lack of important incidental information such as temperature and precipitation. The resulting data combinations, completed to obtain larger data sets, have sometimes been used to create regression equations of questionable value for use in design. Finally, data from constructed wetlands treating relatively high quality (but inadequately characterized) wastewater has sometimes been used to derive design parameters for more concentrated municipal treatment applications, which is less than assuring for any designer.

Misconception #2: Constructed wetlands have aerobic as well as anaerobic treatment zones. Probably the most common misconception concerns the ability of emergent wetland plants to transfer oxygen to their roots. Emergent aquatic plants are uniquely suited to the anaerobic environment of wetlands because they can move oxygen from the atmosphere to their roots. Research has shown that some oxygen "leaks" from the roots into the surrounding soils (Brix, 1997). This phenomenon, and early work with natural and constructed wetlands that treated wastewater with a low oxygen demand, has led to the assumption that significant aerobic micro-sites exist in all wetland systems. Some constructed wetlands literature states or implies that aerobic biodegradation is a significant treatment mechanism in fully vegetated systems, which has led some practitioners to believe that wetlands with dense vegetation, or many sources of "leaking" oxygen, are in fact aerobic systems. However, the early work with tertiary or polishing wetlands is not directly applicable to wetlands treating higher strength wastewater because it fails to account for the impacts of the wastewater on the characteristics of the wetland. Treatment mechanisms that function under light loads are impaired or overwhelmed due to changes imparted by the large oxygen demand of more contaminated municipal wastewater. Field experience and research have shown that the small amount

of oxygen leaked from plant roots is insignificant compared to the oxygen demand of municipal wastewater applied at practical loading rates.

Misconception #3: Constructed wetlands can remove significant amounts of nitrogen. Related to the misconception about the availability of oxygen in constructed wetlands is the misconception about the ability of constructed wetlands to remove significant amounts of nitrogen. Harvesting removes less than 20% of influent nitrogen (Reed, et al, 1995) at conventional loading rates. This leaves nitrification and denitrification as the primary removal mechanisms. If it is assumed that wetlands have aerobic zones, it then follows that nitrification of ammonia to nitrate should occur. Furthermore, if the aerobic zone surrounds only the roots of the plants, it then follows that anaerobic zones dominate, and denitrification of nitrate to nitrogen gas should also occur. Unfortunately, the nitrogen-related misconceptions have been responsible for the failure of several constructed wetlands that were built to remove or oxidize nitrogen. Because anaerobic processes dominate in both VSBs and fully vegetated FWS wetlands, nitrification of ammonia is unlikely to occur in the former and will occur only if open water zones are introduced to the latter. Constructed wetlands can be designed to remove nitrogen, if sufficient aerobic (open water) and anaerobic (vegetated) zones are provided. Otherwise, constructed wetlands should be used in conjunction with other aerobic treatment processes that can nitrify to remove nitrogen.

Misconception #4: Constructed wetlands can remove significant amounts of phosphorus. Phosphorus removal in constructed wetlands is limited to seasonal uptake by the plants, which is not only minor compared to the phosphorus load in municipal wastewater, but is negated during the plants' senescence, and to sorption to influent solids which are captured, soils or plant detritus, all of which have a limited capacity. Two problems have been associated with phosphorus data in the literature. First, some phosphorus removal data has been reported in terms of percent removal. However, many of the early phosphorus studies were for natural wetlands or constructed wetlands that received wastewater with a low phosphorus concentration. Because of low influent concentrations, removal of only a single mg/L of phosphorus was reported as a large percent removal. Second, for studies evaluating the performance of newly constructed wetlands, phosphorus removal data will be uncharacteristic of long-term performance. New plants growing in a freshly planted wetland will uptake more phosphorus than a mature wetland, which will have phosphorus leaching from dying (senescent) plants as well as uptake by growing plants. Also, newly placed soils or media will have a greater phosphorus sorption capacity than a mature system which will have most sorption sites already saturated.

1.7 When to Use Constructed Wetlands

1.7.1 Appropriate Technology for Small Communities

Appropriate technology is defined as a treatment system which meets the following key criteria:

Affordable - Total annual costs, including capital, operation, maintenance and depreciation are within the user's ability to pay.

Operable - Operation of the system is possible with locally available labor and support.

Reliable - Effluent quality requirements can be consistently meet.

Unfortunately, many rural areas of the U.S. with small treatment plants (usually defined as treating less than 3,800 m³/d (1 mgd)) have failed to consider this appropriate technology definition, and have often adopted inappropriate technologies such as activated sludge. In 1980, small, activated sludge systems constituted 39% of the small publicly owned treatment facilities (GAO, 1980). Recent information from one state showed that 73% of all treatment plants of less than 3,800m³/d capacity used some form of the activated sludge process. Unfortunately, the activated sludge process is considered by almost all U.S. and international experts to be the most difficult to operate and maintain of the various wastewater treatment concepts. Presently, small treatment plants constitute more than 90% of the violations of U.S. discharge standards. At least one U.S. state, Tennessee, has required justification for the use of activated sludge package plants for very small treatment plant applications (Tennessee Department of Public Health, 1977).

Small community budgets become severely strained by the costs of their wastewater collection and treatment facilities. Inadequate budgets and poor access to equipment, supplies and repair facilities preclude proper operation and maintenance (O&M). Unaffordable capital costs and the inability to reliably meet effluent quality requirements add up to a prime example of violating the prior criteria for appropriate technology. Unfortunately, no consideration for reuse, groundwater recharge, or other alternatives to stream discharge has heretofore been common, except in a few states where water shortages exist.

Presently there are a limited number of appropriate technologies for small communities which should be immediately considered by a community and their designer. These include stabilization ponds or lagoons, slow sand filters, land treatment systems, and constructed wetlands. All of these technologies fit the operability criterion, and to varying degrees, are affordable to build and reliable in their treatment performance. Because each of these technologies has certain characteristics and requirements for pre- and post- treatment to meet a certain effluent quality, they may be used alone or in series with others depending on the treatment goals.

For example, the designer may wish to supplement stabilization ponds with a tertiary system to meet reuse or discharge criteria consistently. Appropriate stabilization pond upgrading methods to meet effluent standards include FWS wetlands, which can provide the conditions for enhanced settling to attain further reduction of fecal

coliforms and removal of the excess algal growth which characterizes pond system effluents. FWS wetlands are normally used after ponds because of their ability to handle the excess algal solids generated in the ponds. Although VSBs have been employed after ponds, excess algal solids have caused problems at some locations, thus defeating the operability factor in the appropriate technology definition. VSBs are more appropriately applied behind a process designed to minimize suspended and settleable solids, such as a septic or Imhoff tank or anaerobic lagoon.

Constructed wetlands may also require post-treatment processes, depending on the ultimate goals of the treatment system. More demanding effluent requirements may require additional processes in the treatment train or may dictate the use of other processes altogether. For example, the ability of constructed wetlands to remove nitrogen and phosphorus has frequently been overestimated. Two appropriate technologies that readily accomplish ammonium oxidation are intermittent and recirculating sand filters. There is at least one case study of the successful use of a recirculating gravel filter in conjunction with a VSB (Reed, et al, 1995). FWS systems can both nitrify and denitrify, thus removing significant portions of nitrogen from the wastewater, by alternating fully vegetated and open water zones in proper proportions. If the municipal facility is required to have significant phosphorus removal (e.g., to attain 1 mg/L from a typical influent value of 6 to 7 mg/L), constructed wetlands will need to be accompanied by some process or processes that can remove the phosphorus.

In conclusion, constructed wetlands are an appropriate technology for areas where inexpensive land is generally available and skilled labor is less available. Whether they can be used essentially alone or in series with other appropriate technologies depends on the required treatment goals. Additionally, they can be appropriate for onsite systems where local regulators call for and allow systems other than conventional septic tank - soil absorption systems.

1.7.2 Policy and Permitting Issues

An interagency workgroup, including representatives from several Federal agencies, is presently developing Guiding Principles for Constructed Treatment Wetlands: Providing Water Quality and Wildlife Habitat (USEPA, 1999). The essence of the current draft of the guidelines is that constructed treatment wetlands will:

- receive no credit as mitigation wetlands;
- be subject to the same rules as treatment lagoons regarding liner requirements;
- be subject to the same monitoring requirements as treatment lagoons;
- should not be constructed in the waters of the United States, including existing natural wetlands; and
- will not be considered Waters of the United States upon abandonment if the first and the fourth conditions are met.

The guidance encourages use of local plant species and expresses concern about permit compliance during lengthy startup periods and vector attraction and control issues.

To avoid additional permitting and regulatory requirements, constructed wetlands should be designed as a treatment process and built in uplands as opposed to wetlands or flood plains, i.e., outside of waters of the U.S.. Consider the following from the draft guidelines.

If your constructed treatment wetland is constructed in an existing water of the U.S., it will remain a water of the U.S. unless an individual CWA section 404 permit is issued which explicitly authorizes it as an excluded waste treatment system designed to meet the requirements of the CWA. ... Once constructed, if your treatment wetland is a water of the U.S., you will need a NPDES permit for the discharge of pollutants ... into the wetland. ... [Additionally,] if you wish to use a degraded wetland for wastewater treatment and plan to construct water control structures, such as berms or levees, this construction will ... require a Section 404 permit. Subsequent maintenance may also require a permit.

As stated in the guidelines:

If the constructed wetland is abandoned or is no longer being used as a treatment system, it may revert to a water of the U.S. if ... the following conditions exist: the system has wetland characteristics (i.e., hydrology, soils, vegetation) and it is either (1) an interstate wetland, (2) is adjacent to another water of the U.S. (other than waters which are themselves wetlands), or (3) if it is an isolated intrastate water which has a nexus to interstate commerce (e.g., it provides habitat for migratory birds).

None of preceding discussion precludes designing and building a wetland which provides water reuse, habitat or public use benefits in addition to wastewater treatment. Constructed wetlands built primarily for treatment will generally not be given credit as compensatory mitigation to replace wetland losses. However, in limited cases, some parts of a constructed wetland system may be given credit, especially if additional wetland area is created beyond that needed for treatment purposes. Also, current policy encourages the use of properly treated wastewater to restore degraded wetlands. For example, restoration might be possible if:

1 the source water meets all applicable water quality standards and criteria, (2) its use would result in a net environmental benefit to the aquatic system's natural functions and values, and if applicable, (3) it would help restore the aquatic system to its historical condition. Prime candidates for restoration may include wetlands that were degraded or destroyed through the diversion of water supplies, ... For example, in the arid west, there are often historic wetlands that no longer have a reliable water source due to upstream water allocations or sink-

ing groundwater tables. Pre-treated effluent may be the only source of water available for these areas and their dependent ecosystems. ... EPA has developed regional guidance to assist dischargers and regulators in demonstrating a net ecological benefit from maintenance of a wastewater discharge to a waterbody.

This discussion of policy and permitting issues is very general and regulatory decisions regarding these issues are made on a case-by-case basis. Planners and designers should seek guidance from State and Regional regulators about site specific constructed wetland criteria including location, discharge requirements, and possible long-term monitoring requirements.

1.7.3 Other Factors

Probably the most important factor which impacts all aspects of constructed wetlands is their inherent aesthetic appeal to the general public. The desire of people to have such an attractive landscape enhancement treat their wastewater and become a valuable addition to the community is a powerful argument when the need for wastewater treatment upgrading becomes a matter of public debate. The appeal of constructed wetlands makes the need to accurately assess the capability of the technology so important and so difficult. The engineering community often fails to appreciate this inherent appeal, while the environmental community often lacks the understanding of treatment mechanisms to appreciate the limitations of the technology. The natural attraction of constructed wetlands and the potential for other aesthetic benefits may sometimes offset the treatment or cost advantages of other treatment options, and public opinion may dictate that a constructed wetland is the preferred option. In other situations, constructed wetlands will be too costly or unable to produce the required effluent water quality, and the designer will have to convince the public that wetlands are not a viable option, in spite of their inherent appeal.

The use of constructed wetlands as a treatment technology carries some degree of risk for several reasons. First, as noted in a review of constructed wetlands for wastewater treatment by Cole (1998), constructed wetlands are not uniformly accepted by all state regulators or EPA regions. Some authorities encourage the use of constructed wetlands as a proven treatment technology, due in part to the misconceptions noted in Section 1.6. Others still consider them to be an emerging technology. As with any new treatment technology, uniform acceptance of constructed wetlands will take some time. Other natural treatment processes which are now generally accepted, such as slow rate or overland flow land treatment systems, went through a similar course of variable acceptance.

Second, although there is no evidence of harm to wildlife using constructed wetlands, some regulators have expressed concern about constructing a system which will treat wastewater while it attracts wildlife. Unfortunately, there has not been any significant research conducted on the risks to wildlife using constructed wetlands. Although

they are a distinctly different type of habitat, the lack of evidence of risks to wildlife using treatment lagoon systems for many years suggests that there may not be a serious risk for wetlands treating municipal wastewater. Of course, if a wetland is going to treat wastewater with high concentrations of known toxic compounds, the designer will need to use a VSB system or incorporate features in a FWS wetland which restrict access by wildlife.

Finally, as noted earlier, due to the lack of a large body of scientifically valid data, the design process is still empirical, that is, based upon observational data rather than scientific theories. Due to the variability of many factors at constructed wetlands being observed by researchers (e.g., climatic effects, influent wastewater characteristics, design configurations, construction techniques, and O&M practices), there will continue to be disagreement about some design and performance issues for some period of time.

1.8 Use of This Manual

Chapters 1, 2, 7 and 8 provide information for non-technical readers, such as decision-makers and stakeholders, to understand the capabilities and limitations of constructed wetlands. These chapters provide the type of information required to question designers and regulators in the process of determining how constructed wetlands may be used to expand, upgrade or develop wastewater treatment infrastructure.

Chapters 3 through 6 provide information for technical readers, such as design engineers, regulators and planners, to plan, design, build and manage constructed wetlands as part of a comprehensive plan for local and regional management of municipal wastewater collection, treatment, and reuse.

Chapter 2 describes constructed wetland treatment systems and their identifiable features. It answers the most frequently asked questions about these systems and includes a glossary of terms which are used in this manual and generally in discussion of constructed wetland systems. There are brief discussions of other aquatic treatment systems that are in use or are commercially available and an annotated introduction to specific uses for constructed wetlands outside the purview of this manual.

Chapter 3 discusses the treatment mechanisms occurring in a constructed wetland to help the reader understand the most important processes and what climatic conditions and other physical phenomena most affect these processes. A basic understanding of the mechanisms involved will allow the reader to more intelligently interpret information from other literature sources as well as information in chapters 4 and 5 of this manual.

Chapters 4, 5, and 6 describe the design, construction, startup and operational issues of constructed wetlands in some detail. It will be apparent to the reader that there are presently insufficient data to create treatment models in which there can be great confidence. Most data in the lit-

erature has been generated with inadequate quality assurance and control (Qa/Qc), and most research studies have not measured or focused on documentation of key variables which could explain certain performance characteristics. Chapters 4 and 5 use the existing data of sufficient quality to create a viable approach to applicability and design of both FWS and VSB systems and sets practical limits on their performance capabilities. Chapter 6 deals with the practical issues of construction and start-up of these systems which have been experienced to date.

Chapter 7 contains cost information for constructed wetlands. Subsequent to standardizing the costs to a specific time, it becomes clear that local conditions and requirements can dominate the costs. However, the chapter does provide a reasonable range of expected costs which can be used to evaluate constructed wetlands against other alternatives in the facility planning stage. Also, there is sufficient information presented to provide the user with a range of unit costs for certain components and to indicate those components that dominate system costs and those that are relatively inconsequential.

Chapter 8 presents eight case studies to allow readers to become familiar with sites that have used constructed wetlands and their experiences. The systems in this chapter are not ones which are superior to other existing facilities, but they are those which have been observed and from which lessons can be learned by the reader about either successful or unsuccessful design practices.

1.9 References

- Brix, H. 1997. Do Macrophytes Play a Role in Constructed Treatment Wetlands?. *Water Science & Technology*, Vol 35, No. 5, pp.11-17.
- Campbell, C.S. and M.H. Ogden. 1999. *Constructed Wetlands in the Sustainable Landscape*. John Wiley and Sons, New York, New York.
- Cole, Stephen. 1998. The Emergence of Treatment Wetlands. *Environmental Science & Technology*, Vol. 3, No.5, pp 218A-223A.
- Cooper, P.F., and B.C. Findlater, eds. 1990. *Constructed Wetlands in Water Pollution Control*. Pergamon Press, New York, New York.
- EC/EWPCA. 1990. *European Design and Operations Guidelines for Reed Bed Treatment Systems*. Prepared for the EC/EWPCA Expert Contact Group on Emergent Hydrophyte Treatment Systems. P.F. Cooper, ed., European Community/European Water Pollution Control Association.
- Government Accounting Office. 1980. *Costly wastewater treatment plants fail to perform as expected*. CED-81-9. Washington, D.C.
- Hammer, D.A., ed. 1989. *Constructed Wetlands for Wastewater Treatment*. Lewis Publishers, Inc. Chelsea, Michigan.

-
- IAWQ. 1992. Proceedings of international conference on treatment wetlands, Sydney, Australia. *Water Science & Technology*. Vol. 29, No. 4.
- IAWQ. 1995. Proceedings of international conference on treatment wetlands, Guangzhou, China. *Water Science & Technology*. Vol. 32, No. 3.
- IAWQ. 1997. Proceedings of international conference on treatment wetlands, Vienna, Austria. *Water Science & Technology*. Vol. 35, No. 5.
- Kadlec, R.H. and R.L. Knight. 1996. *Treatment Wetlands*. CRC Press LLC. Boca Raton, FL.
- Moshiri, L., ed. 1993. *Constructed Wetlands for Water Quality Improvement*. Lewis Publishers, Inc., Chelsea, MI.
- Niering, W.A. 1985. *Wetlands*. Alfred A. Knopf, Inc., New York, NY.
- Reed, S.C., R.W. Crites, and J.E. Middlebrooks. 1995. *Natural Systems for Waste Management and Treatment*. Second edition. McGraw-Hill, Inc., New York, NY.
- Tennessee Department of Public Health. 1977. Regulations for plans, submittal, and approval; Control of construction; Control of operation. Chapter 1200-4-2, State of Tennessee Administrative Rules. Knoxville, TN.
- Tennessee Valley Authority. 1993. *General Design, Construction, and Operation Guidelines: Constructed Wetlands Wastewater Treatment Systems for Small Users Including Individual Residences*. G.R. Steiner and J.T. Watson, eds. 2nd edition. TVA Water Management Resources Group. TVA/WM--93/10. Chattanooga, TN.
- U.S. Department of Agriculture. 1995. *Handbook of Constructed Wetlands*. 5 volumes. USDA-Natural Resources Conservation Service/US EPA-Region III/Pennsylvania Department of Natural Resources. Washington, D.C.
- U.S. Environmental Protection Agency. 1988. *Design Manual: Constructed Wetlands and Aquatic Plant Systems for Municipal Wastewater Treatment*. EPA/625/1-88/022. US EPA Office of Research and Development, Cincinnati, OH.
- U.S. Environmental Protection Agency. 1993. *Subsurface Flow Constructed Wetlands for Wastewater Treatment: A Technology Assessment*. S.C. Reed, ed., EPA/ 832/R-93/008. US EPA Office of Water, Washington, D.C.
- U.S. Environmental Protection Agency. 1994. *Wetlands Treatment Database (North American Wetlands for Water Quality Treatment Database)*. R.H. Kadlec, R.L. Knight, S.C. Reed, and R.W. Ruble eds., EPA/ 600/C-94/002. US EPA Office of Research and Development, Cincinnati, OH.
- U.S. Environmental Protection Agency. 1999. *Final Draft -- Guiding Principles for Constructed Treatment Wetlands: Providing Water Quality and Wildlife Habitat*. Developed by the Interagency Workgroup on Constructed Wetlands (U.S. Environmental Protection Agency, Army Corps of Engineers, Fish and Wildlife Service, Natural Resources Conservation Services, National Marine Fisheries Service, and Bureau of Reclamation). Final Draft 6/8/1999. <http://www.epa.gov/owow/wetlands/constructed/guide.html>
- Water Pollution Control Federation. 1990. *Natural Systems for Wastewater Treatment. Manual of Practice FD-16*, S.C. Reed, ed., Water Pollution Control Federation, Alexandria, VA.

Chapter 2 Introduction to Constructed Wetlands

2.1 Understanding Constructed Wetlands

Constructed wetlands are wastewater treatment systems composed of one or more treatment cells in a built and partially controlled environment designed and constructed to provide wastewater treatment. While constructed wetlands have been used to treat many types of wastewater at various levels of treatment, the constructed wetlands described in this manual provide secondary treatment to municipal wastewater. These are treatment systems that receive primary effluent and treat it to secondary effluent standards and better, in contrast to enhancement systems or polishing wetlands, which receive secondary effluent and treat it further prior to discharge to the environment.

This distinction emphasizes the degree of treatment more than the means of treatment, because the constructed wetlands described in this manual receive higher-strength wastewater than the polishing wetlands that have been widely used as wastewater treatment systems for the last 20 years.

While constructed wetlands discussed in this manual provide secondary treatment in a community's wastewater treatment system, this technology also can be used in combination with other secondary treatment technologies. For example, a constructed wetland could be placed upstream in the treatment train from an infiltration system to optimize the cost of secondary treatment. In other uses, constructed wetlands could discharge secondary effluent to enhancement wetlands for polishing. Constructed wetlands are not recommended for treatment of raw wastewater. Figure 2-1 portrays a hypothetical wastewater treatment train utilizing constructed wetlands in series.

The distinction between constructed wetlands for secondary treatment and enhancement systems for tertiary treatment is critical in understanding the limitations of earlier accounts of wetland-based treatment systems and databases of system performance. Most of the commonly available information on constructed wetland treatment systems is derived from data gathered at many larger polishing wetlands and a relatively few smaller constructed wetlands for secondary treatment. In the past, largely unverified data from these disparate sources has been aggregated, statistically rendered, and then applied as guidance for constructed wetland systems, with predictably

inconsistent results. In contrast, guidance offered in this manual is drawn from reliable research data and practical application in constructed wetlands for secondary treatment of higher-strength municipal wastewater.

Constructed wetlands comprise two types of systems that share many characteristics but are distinguished by the location of the hydraulic grade line. Design variations for both types principally affect shapes and sizes to fit site-specific characteristics and optimize construction, operation, and performance. Both types of constructed wetlands typically may be fitted with liners to prevent infiltration, depending on local soil conditions and regulatory requirements.

Free water surface (FWS) constructed wetlands closely resemble natural wetlands in appearance and function, with a combination of open-water areas, emergent vegetation, varying water depths, and other typical wetland features. Figure 2-2 illustrates the main components of a FWS constructed wetland. A typical FWS constructed wetland consists of several components that may be modified among various applications but retain essentially the same features. These components include berms to enclose the treatment cells, inlet structures that regulate and distribute influent wastewater evenly for optimum treatment, various combinations of open-water areas and fully vegetated surface areas, and outlet structures that complement the even distribution provided by inlet structures and allow adjustment of water levels within the treatment cell. Shape, size, and complexity of design often are functions of site characteristics rather than preconceived design criteria.

Vegetated submerged bed (VSB) wetlands consist of gravel beds that may be planted with wetland vegetation. Figure 2-3 provides a schematic drawing of a VSB system. A typical VSB system, like the FWS systems described above, contains berms and inlet and outlet structures for regulation and distribution of wastewater flow. In addition to shape and size, other variable factors are choice of treatment media (gravel shape and size, for example) as an economic factor, and selection of vegetation as an optional feature that affects wetland aesthetics more than performance.

The apparent simplicity and natural function of constructed wetlands may obscure the complexity of interac-



Figure 2-1. Constructed wetlands in wastewater treatment train

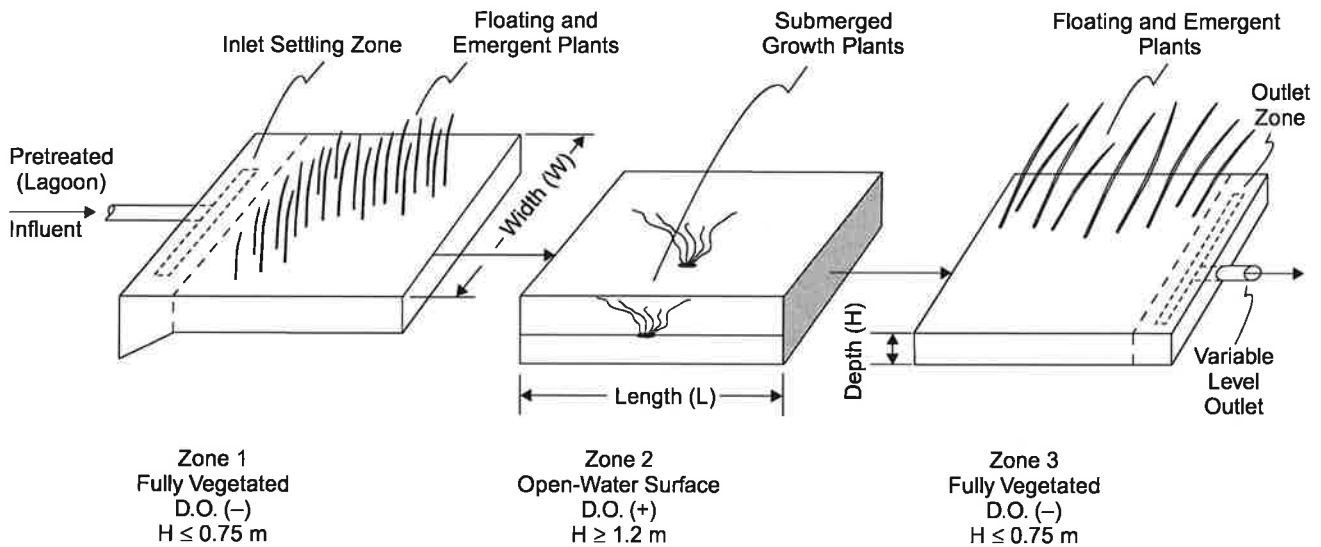


Figure 2-2. Elements of a free water surface (FWS) constructed wetland

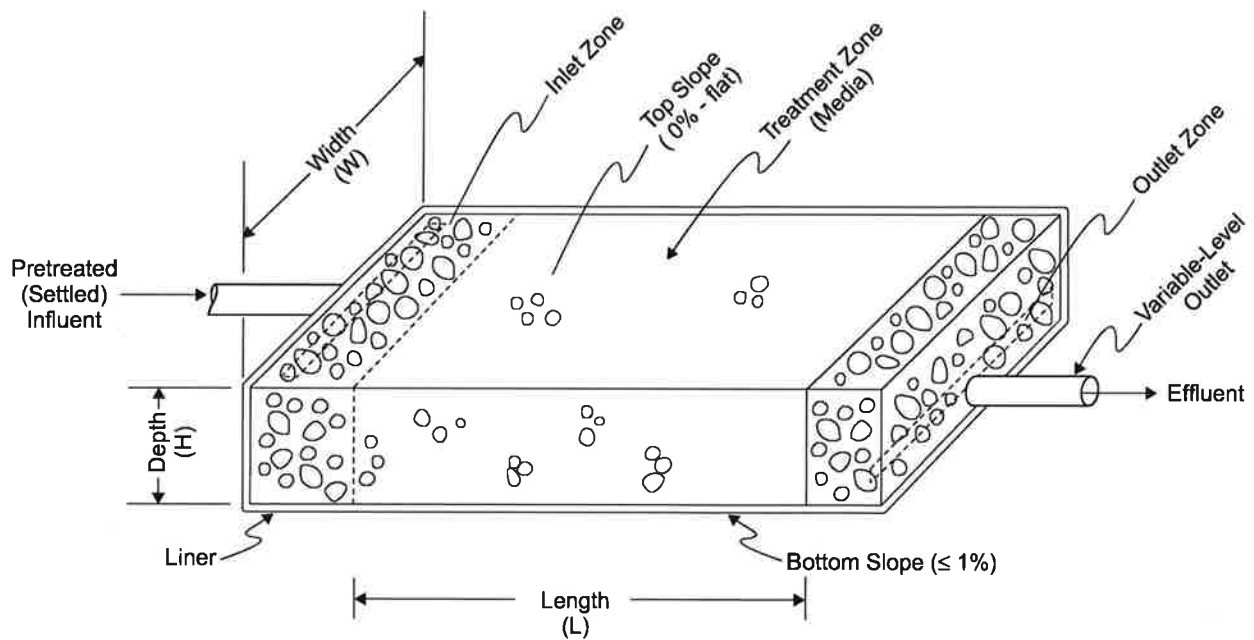


Figure 2-3. Elements of a vegetated submerged bed (VSB) system

tions required for effective wastewater treatment. Unlike natural wetlands, constructed wetlands are designed and operated to meet certain performance standards. Once a constructed wetland is designed and becomes operational, the system requires regular monitoring to ensure proper operation. Based on monitoring results, these systems may need minor modifications, in addition to routine management, to maintain optimum performance.

In this chapter, a basic understanding of constructed wetland ecology is presented for planners, policy makers, local government officials, and others involved in the application of constructed wetlands for wastewater treatment. Basic ecological components and functions of wetlands are briefly described to bring readers to a common level of understanding, but detailed descriptions are purposely omitted for the sake of focus and relative correlation to treatment performance. To enhance one's knowledge of wetland ecology, many publications are commonly available. For designers and operators, general knowledge of wetland ecology is assumed, and detailed information on constructed wetlands is offered in succeeding chapters. While municipal wastewater treatment systems utilizing constructed wetlands modeled on the functions of natural wetlands systems are the focus of this manual, related systems utilizing components of natural wetland systems also are briefly described. In addition, constructed wetlands for on-site domestic wastewater systems and non-municipal wastewater treatment are introduced.

Because VSB wetlands are not dependent on wetland vegetation for treatment performance and do not require open-water areas, portions of this chapter describe design and management considerations that pertain only to FWS wetlands. For reference purposes, important terms are highlighted in bold type and are explained in a glossary at the end of the chapter.

2.2 Ecology of Constructed Wetlands

Constructed wetlands are ecological systems that combine physical, chemical, and biological processes in an engineered and managed system. Successful construction and operation of an ecological system for wastewater treatment requires a basic knowledge and understanding of the components and the interrelationships that compose the system.

The treatment systems of constructed wetlands are based on ecological systems found in natural wetlands. A main distinction between constructed wetlands and natural wetlands is the degree of control over natural processes. For example, a constructed wetland operates with a relatively stable flow of water through the system, in contrast to the highly variable water balance of natural wetlands, mostly due to the effects of variable precipitation. As a result, wetland ecology in constructed wetlands is affected by continuous flooding and concentrations of total suspended solids (TSS), biochemical oxygen demand (BOD), and other wastewater constituents at consistently higher levels than would otherwise occur in nature.

In a constructed wetland, most of the inflow is a predictable volume of wastewater discharged through sewers. Lesser volumes of precipitation and surface runoff are subject to seasonal and annual variations. Losses from these systems can be calculated by measuring outflow and estimating evapotranspiration as well as by accounting for seepage in unlined systems. Even with predictable inflow rates, however, modeling the water balance of constructed wetlands must comprehend weekly and monthly variations in precipitation and runoff and the effects of these variables on wetland hydraulics, especially detention time required for treatment. See Chapter 3 for a more thorough discussion of modeling concerns.

Temperature variations also affect the treatment performance of constructed wetlands, although not consistently for all wastewater constituents. Treatment performance for some constituents tends to decrease with colder temperatures, but BOD and TSS removal through flocculation, sedimentation, and other physical mechanisms is less affected. In colder months, the absence of plant cover would allow atmospheric reaeration and solar insolation to occur without the shading and surface covering that plant cover provides during the growing season. Ice cover is another seasonal variable that affects constructed wetlands by altering wetland hydraulics and restricting solar insolation, atmospheric reaeration, and biological activity; however, the insulating layer provided by ice cover would slow down the rate and degree of cooling in the water column but would not affect physical processes such as settling, filtration, and flocculation. Plant senescence and decay also decreases under ice cover, with a corresponding decrease in effluent BOD.

2.3 Botany of Constructed Wetlands

Successful performance of constructed wetlands depends on ecological functions that are similar to those of natural wetlands, which are based largely on interactions within plant communities. Research has confirmed that treatment of typical wastewater pollutants (TSS and BOD) in FWS constructed wetlands generally is better in cells with plants than in adjoining cells without plants (Bavor et al., 1989; Burgoon et al., 1989; Gearheart et al., 1989; Thut, 1989). However, the mechanisms by which plant populations enhance treatment performance have yet to be determined fully. Some authors have hypothesized a relationship between plant surface area and the density and functional performance of attached microbial populations (EPA, 1988; Reed et al., 1995), but demonstrations of this relationship have yet to be proven.

Plant communities in constructed wetlands undergo significant changes following initial planting. Very few constructed wetlands maintain the species composition and density distributions envisioned by their designers. Many of these changes are foreseeable, and many have little apparent effect on treatment performance. Other changes, however, may result in poor performance and the consequent need for increased management. The following sections summarize basic principles of plant ecology that may aid in understanding of constructed wetlands.

2.3.1 Wetland Microbial Ecology

In any wetland, the ecological food web requires microscopic bacteria, or microbes, to function in all of its complex transformations of energy. In a constructed wetland, the food web is fueled by influent wastewater, which provides energy stored in organic molecules. Microbial activity is particularly important in the transformations of nitrogen into varying biologically useful forms. In the various phases of the nitrogen cycle, for example, different forms of nitrogen are made available for plant metabolism, and oxygen may be either released or consumed. Phosphorus uptake by plants also is dependent in part on microbial activity, which converts insoluble forms of phosphorus into soluble forms that are available to plants. Microbes also process the organic (carbon) compounds, and release carbon dioxide in the aerobic areas of a constructed wetland and a variety of gases (carbon dioxide, hydrogen sulfide, and methane) in the anaerobic areas. Plants, plant litter, and sediments provide solid surfaces where microbial activity may be concentrated.

Microbial activity varies seasonally in cold regions, with lesser activity in colder months, although the performance differential in warm versus cold climates is less in full-scale constructed wetlands than in small-scale, controlled experiments (Wittgren and Maehlum, 1996), apparently because of the multiplicity of physical, chemical, and biological transformations taking place simultaneously over a larger contiguous area.

2.3.2 Algae

Algae are ubiquitous in wet habitats, and they inevitably become components of FWS systems. While algae are a major component in certain treatment systems (for example, lagoons), algae can affect treatment performance of FWS constructed wetlands significantly. As a result, the presence of algae must be anticipated in the design stage.

Algae in open areas, especially in areas of submergent vegetation, can form a living canopy that blocks sunlight from penetrating the water column to that vegetation, which results in reduced dissolved oxygen (DO) levels. The presence of open, unshaded water near the outlet of a constructed wetland typically promotes seasonal blooms of phytoplanktonic algal species, which results in elevated concentrations of suspended solids and particulate nutrient forms in the effluent.

Several floating aquatic plant species, especially duckweed, have very high rates of primary production, which result in large quantities of biomass and trapped nonliving elements accumulating within the fully vegetated portion of the FWS wetland and pond systems (Table 2-1). Water hyacinth can also perform well in pond systems in tropical climates to enhance TSS and algal removal. However, both species block sunlight and lower DO levels by eliminating atmospheric reaeration at the water/air interface.

High growth rates of these plants have led to specialized wastewater treatment systems that use these plants for harvesting nutrients from wastewater. The disadvan-

tages of harvesting these plants arise from their low % solids (typically less than 5% on a wet-weight basis) and the consequent need for drying prior to disposal, which simultaneously creates secondary odor and water-quality problems. For disposal, harvested duckweed, which has a high protein content, typically has been incorporated into agricultural soils as green manure, and water hyacinths have been partially dried and landfilled or allowed to decompose in a controlled environment to produce methane as a useful by-product. However, numerous attempts to demonstrate beneficial and cost-effective by-product recovery have been mostly unsuccessful under North American social and economic conditions.

2.3.3 Emergent Herbaceous Plants

Emergent herbaceous wetland plants are very important structural components of wetlands. Their various adaptations allow competitive growth in saturated or flooded soils. These adaptations include one or more of the following traits: lenticels (small openings through leaves and stems) that allow air to flow into the plants; aerenchymous tissues that allow gaseous convection throughout the length of the plant, which provides air to plant roots; special morphological growth structures, such as buttresses, knees, or pneumatophores, that provide additional root aeration; adventitious roots for absorption of gases and plant nutrients directly from the water column; and extra physiological tolerance to chemical by-products resulting from growth in anaerobic soil conditions.

The primary role of emergent vegetation in FWS systems is providing structure for enhancing flocculation, sedimentation, and filtration of suspended solids through idealized hydrodynamic conditions. Emergent wetland plant species also play a role in winter performance of FWS constructed wetlands by insulating the water surface from cold temperatures, trapping falling and drifting snow, and reducing the heat-loss effects of wind (Wittgren and Maehlum, 1996).

Limited information is available to demonstrate significant or consistent effects of plant species selection on constructed wetland performance. For example, in two similar FWS treatment cells at the Iron Bridge Wetland in Florida, the major difference between the cells was the dominant plant species. Bulrush appeared to perform nearly the same as cattail in treatment of BOD, TSS, total nitrogen (TN), and total phosphorus (TP). As research and application of constructed wetlands have expanded, documentation of actual performance differences between emergent marsh plant species in constructed wetlands has become increasingly less valuable to constructed wetland designers.

The wetland designer is strongly encouraged to seek information from experienced local wetland practitioners when selecting emergent herbaceous species to ensure selection of locally successful species. Table 2-2 provides guidelines for initial selection and establishment of plant species adapted to wetland environments.

Table 2.1 Characteristics of plants for constructed wetlands

General Types of Plants	General Characteristics and Common Examples	Function or Importance to Treatment Process	Function or Importance for Habitat	Design & Operational Considerations
Free-Floating Aquatic	Roots or root-like structures suspended from floating leaves. Will move about with water currents. Will not stand erect out of the water. Common duckweed (<i>Lemna</i>), Big duckweed (<i>Spirodela</i>).	Primary purposes are nutrient uptake and shading to retard algal growth. Dense floating mats limit oxygen diffusion from the atmosphere. Duckweed will be present as an invasive species.	Dense floating mats limit oxygen diffusion from the atmosphere and block sunlight from submerged plants. Plants provide shelter and food for animals.	Duckweed is a natural invasive species in North America. No specific design is required.
Rooted Floating Aquatic	Usually with floating leaves, but may have submerged leaves. Rooted to bottom. Will not stand erect out of the water. Water lily (<i>Nymphaea</i>), Pennywort (<i>Hydrocotyle</i>).	Primary purposes are providing structure for microbial attachment and releasing oxygen to the water column during daylight hours. Dense floating mats limit oxygen diffusion from the atmosphere.	Dense floating mats limit oxygen diffusion from the atmosphere and block sunlight from submerged plants. Plants provide shelter and food for animals.	Water depth must be designed to promote the type of plant (i.e. floating, submerged, emergent) desired while hindering other types of plants.
Submerged Aquatic	Usually totally submerged; may have floating leaves. Rooted to bottom. Will not stand erect in air. Pondweed (<i>Potamogeton</i>), Water weed (<i>Elodea</i>).	Primary purposes are providing structure for microbial attachment and providing oxygen to the water column during daylight hours.	Plants provide shelter and food for animals (especially fish).	Retention time in open water zone should be less than necessary to promote algal growth which can destroy these plants through sunlight blockage.
Emergent Aquatic	Herbaceous (i.e. non-woody). Rooted to the bottom. Stand erect out of the water. Tolerate flooded or saturated conditions. Cattail (<i>Typha</i>), Bulrush (<i>Scirpus</i>), Common Reed (<i>Phragmites</i>).	Primary purpose is providing structure to induce enhanced flocculation and sedimentation. Secondary purposes are shading to retard algal growth, windbreak to promote quiescent conditions for settling, and insulation during winter months.	Plants provide shelter and food for animals. Plants provide aesthetic beauty for humans.	Water depths must be in the range that is optimum for the specific species chosen (planted).
Shrubs	Woody, less than 6 m tall. Tolerate flooded or saturated soil conditions. Dogwood (<i>Cornus</i>), Holly (<i>Ilex</i>).	Treatment function is not defined; it is not known if treatment data from unsaturated or occasionally saturated phytoremediation sites in upland areas is applicable to continuously saturated wetland sites.	Plants provide shelter and food for animals (especially birds). Plants provide aesthetic beauty for humans.	Possible perforation of liners by roots.
Trees	Woody, greater than 6 m tall. Tolerate flooded or saturated soil conditions. Maple (<i>Acer</i>). Willow (<i>Salix</i>).	(same as for shrubs)	(same as for shrubs)	(same as for shrubs)

2.3.4 Plant Nutrition and Growth Cycles

Wetland plants require optimum environmental conditions in each phase of their life cycles, including germination and initial plant growth, adequate nutrition, normal seasonal growth patterns, and rates of plant senescence and decay. For more detailed information on wetland plant ecology, the nonbiologist is referred to the wetland ecology text by Mitsch and Gosselink (1993) and portions of the constructed wetland text by Kadlec and Knight (1996).

A wide variety of references describe growth cycles, timing of seed release, overwintering ability, energy cycling, and other characteristics and processes that provide wetland plant species with a competitive advantage in their

natural habitats; the reader is referred to other sources for detailed information. An overview of important characteristics follows.

Emergent herbaceous wetland species planted early in the growing season in temperate climates generally multiply by vegetative reproduction to a maximum total standing biomass in late summer or early fall within a single growing season. This biomass may represent multiple growth and death periods for individual plants during the course of the growing season, or it may represent a single emergence of plant structures, depending on the species. For many species, seeds are produced along with maximum standing crop and released with maturation in the fall for early germination in the spring.

Table 2.2 Factors to Consider in Plant Selection (adapted from Thunhorst, 1993)

Factors	Comments
Consult local experts	The number of professional wetland scientists, practitioners, and plant nurseries has increased dramatically in the past 10 years. Help from an experienced, local person should be available from a variety of sources, including government agencies and private companies.
Native species	Using plants that grow locally increases the likelihood of plant survival and acceptance by local officials.
Invasive or aggressive species	Plants that have extremely rapid growth, lack natural competitors, or are allelopathic* can crowd out all other species and destroy species diversity. State or local agencies may ban the use of some species.
Tolerant of high nutrient load	Unlike natural wetlands, constructed wetlands will receive a continuous inflow of wastewater with high nutrient concentrations. Plants that can not tolerate this condition will not survive.
Tolerant of continuous flooding	Unlike natural wetlands, which may experience periodic or occasional dry periods, constructed wetlands will receive a continuous inflow of wastewater. Plants that require periodic or occasional drying as part of their reproductive cycle will not survive.
Growth characteristics	Perennial plants are generally preferred over annual plants because plants will continue growing in the same area and there is no concern about seeds being washed or carried away. For emergent species, persistent plants are generally preferred over semi- or non-persistent plants because the standing plant material provides added shelter and insulation during the winter season.†
Available form for planting	Costs of obtaining and planting the plants will vary depending on the form of planting material, which may be available in a variety of forms depending on the plant species. Entire plant forms (e.g. bare root plants or plugs) will usually cost more than partial plant material (e.g. seeds or rootstock), but the plant supplier may guarantee a higher survival rate.‡
Rate of growth	Slower growing plants will require a greater number of plants, planted closer together, at start-up to obtain the same density of plant coverage in the initial growing season.
Wildlife benefits	If the wetland is to be used for habitat, plants that provide food, shelter/cover and nesting/nursery for the desired animals should be chosen.
Plant diversity	Mono-cultures of plants are more susceptible to decimation by insect or disease infestations; catastrophic infestations will temporarily affect treatment performance. Greater plant diversity will also tend to encourage a greater diversity of animals.

* Allelopathic - plants that have harmful effects on other plants by secreting toxic chemicals

† Perennial - aboveground portion dies, but below-ground portion remains dormant and sprouts in the next growing season.

Annual - entire plant dies and reproduction is only by seed produced before the plant dies.

Persistent - aboveground dead portions remain upright through the dormant season.

Semi-persistent - aboveground dead portions may remain standing for some part of the dormant season before falling into clumps.

Non-persistent - aboveground dead portions decay and wash away at the end of the growing season.

‡ Bare root plant - seedling with soil washed from roots. Plug - seedling with soil still on roots. Rootstock - piece of underground stem (rhizome).

For some species with high lignin content, particularly cattail, bulrush, and common reed, much of the plant remains standing as dead biomass that slowly decays during the winter season. In FWS systems, this standing dead biomass provides additional structure for enhanced flocculation and sedimentation that is important in wetland treatment performance throughout the annual cycle. Dead biomass, both standing and fallen, also is important to root viability under flooded, winter conditions because of the insulating layer it provides, in addition to its contribution to the internal load on the system.

Like all plants, wetland plants require many macro- and micronutrients in proper proportions for healthy growth. While municipal wastewater can supply adequate quantities of these limiting nutrients, other types of wastewater, including industrial wastewater, acid mine drainage, and stormwater, may not.

Nitrogen and phosphorus are key nutrients in the life cycles of wetland plants. However, plant uptake of nitrogen and phosphorus is not a significant mechanism for removal of these elements in most wetlands receiving partially treated municipal wastewater because nitrogen and phosphorus are taken up and released in the cycle of plant growth and death. Nonetheless, undecomposed litter from dead biomass provides storage for phosphorus, metals, and other relatively conservative elements (Kadlec and Knight, 1996).

While uptake rates of nitrogen and phosphorus are potentially high, harvesting plant biomass to remove these nutrients has been limited to floating aquatic plant communities, in which the plants can be harvested with only brief altering of system performance. Although common reed is harvested annually from certain European constructed wetlands as a by-product (and not for nutrient reduction), full-scale constructed wetlands where plants are

routinely harvested have not been documented in the United States.

2.4 Fauna of Constructed Wetlands

The role that animal species may play in constructed wetlands is a consideration for management of FWS wetlands. Animals typically compose less biomass than do wetland plants, but animals are able to alter energy and mass flows disproportionately to their biomass contribution. During outbreaks of insect pests in constructed wetlands, for example, entire marshes and floating aquatic plant systems can be defoliated, which interrupts mineral cycles and upsets water-quality treatment performance. In another example, the rooting action of bottom-feeding fish (primarily carp) causes sediment resuspension, which affects performance of constructed wetlands in removing suspended solids and associated pollutants. The presence of large seasonal waterfowl populations has had similar results in constructed wetlands at Columbia, Missouri, and elsewhere. In VSB wetlands, only avian species play a significant role.

While wildlife species play generally positive, secondary roles in constructed wetlands, their presence also may generate unintended consequences. Bird species common to wetland environments, for example, typically attract birdwatchers, who may provide public support for municipi-

ties and industries employing this treatment technology. The presence of the public at constructed wetlands for secondary treatment, however, necessitates management efforts to ensure adequate protection from human health and safety risks presented by exposure to primary effluent (see also section 2.6). Conversely, regulatory concern for potentially vulnerable wildlife species has impeded plans for constructed wetlands at certain sites and for certain wastewaters with toxic constituents.

Free water surface wetlands closely resemble the ecology of natural wetlands and aquatic habitats, and they inevitably attract animal species that rely on wet environments during some or all of their life history. All animal groups are represented in constructed wetlands: protozoans, insects, mollusks, fish, amphibians, reptiles, birds, and mammals. Table 2-3 summarizes animal species that may be found in constructed wetlands.

2.5 Ecological Concerns for Constructed Wetland Designers

Wetland ecology is integral to the success of constructed wetlands because of their complexity and their accessibility to wildlife. While the ecology of VSB systems relates more to its subsurface than its surface environment, wetland plants and other surface features that are characteristic of VSB wetlands also require consideration.

Table 2.3 Characteristics of Animals Found in Constructed Wetlands

Animal Group	Members of Group Commonly Found in Treatment Wetlands	Function or Importance to Treatment Process	Design & Operational Considerations
Invertebrates, including protozoa, insects, spiders, and crustaceans	A wide variety will be present, but diversity and populations will vary seasonally and spatially.	Undoubtedly play a role in chemical and biological cycling and transformations and in supporting food web for higher organisms, but exact functions have not been defined	Mosquito control must be considered; mono-cultures of plants are more susceptible to decimation by insect infestations
Fish	Species adapted to living at or near the surface (mosquitofish, mudminnow); species adapted to living in polluted waters (bowfin, catfish, killifish, carp).	Consumers of insects and decaying material (e.g. mosquitofish eat mosquito larvae).	Anaerobic conditions will limit populations; nesting areas required; bottom-feeders can uproot plants and resuspend sediments.
Amphibians and Reptiles	Frogs, alligators, snakes, turtles	Consumers of lower organisms	Turtles have an uncanny ability to fall into water control structures and to get caught in pipes, so turtle exclusion devices are needed; monitoring of control structures and levees for damage or obstruction is needed.
Birds	A wide variety (35-63 species*) are present, including forest and prairie species as well as waterfowl, but diversity and populations vary seasonally and spatially.	Consumers of lower organisms	Heavy use, especially by migratory waterfowl, can contribute to pollutant load on a seasonal basis.
Mammals	Small rodents (shrews, mice, voles); large rodents (rabbits, nutria, muskrats, beaver); large grazers (deer); large carnivores (opossums, raccoons, foxes).	Consumers of plants and lower organisms	Nutria and muskrat populations can reach nuisance levels, removing vegetation and destroying levees; structural controls and animal removal may be required.

* McAllister, 1992, 1993a, 1993b

Constructed wetlands invariably attract wildlife, a factor that must be considered in the design and management of constructed wetlands. As components of an ecological community, animals in general perform vital ecological functions in constructed wetlands. Specific roles of animals in the development and operation of constructed wetlands, however, are not well researched. Experience has shown that many animals are beneficial elements in constructed wetlands, but many other are nuisance species. Proper attention to desirable and undesirable wildlife species, as well as primary and ancillary functions of constructed wetlands, will aid the success of a constructed wetland.

2.5.1 Primary and Ancillary Functions of Constructed Wetlands

Primary functions of most constructed wetlands include water storage and water-quality improvement. Some of these constructed wetlands are designed intentionally for ground water recharge. Numerous other functions attributed to natural wetlands are important in constructed wetlands and are described in succeeding chapters.

Ancillary functions include primary production of organic carbon by plants; oxygen production through photosynthesis; production of wetland herbivores, as well as predator species that range beyond the wetland boundaries; reduction of export of organic matter and nutrients to downstream ecosystems; and creation of cultural values in terms of educational and recreational resources. One or more of these ancillary functions may be an important goal in some constructed wetland projects. For detailed descriptions of ancillary functions, the reader is referred to information presented elsewhere (Feierabend, 1989; Sather, 1989; Knight, 1992).

2.5.2 Wildlife Access Controls

Successful wildlife management in FWS wetlands requires maintaining a balance between attracting beneficial species and controlling pest species (EPA, 1993a). While most wildlife species in wetlands are attractive but often unnoticed, many species are attractive for aesthetic reasons but are impediments to the success of constructed wetlands. Nuisance species in constructed wetlands include burrowing rodents, especially beavers, nutria, and muskrats, which burrow through berms and levees and consume beneficial emergent vegetation; mosquitoes, which cause annoyance and health concerns; and certain bottom-feeding fish, such as carp, which uproot aquatic vegetation and cause increases in effluent TSS and associated pollutants by stirring up sediments and resuspending them in the water column. Waterfowl in large numbers also may be undesirable because they cause similar problems, and their nutrient-rich droppings place additional demands on the water-quality performance of constructed wetlands.

Control of wildlife access in constructed wetlands is highly site-specific; as a result, control measures must be based on geographic location, nuisance species, wetland design, and preferred levels of management. Control methods are

applied throughout the planning, construction, and operation of constructed wetland projects. Control of carp, for example, can be anticipated during design and managed with winter drawdown of water levels and subsequent in-depth freezing in northern climates. Also effective is drawdown and physical removal of stranded individuals, but this method is more labor intensive and less effective in eradicating carp populations. Large rodents can be screened out of culverts to limit access and prevent damming; however, trapping and physical removal may be needed to prevent burrowing and subsequent undermining of banks and other damage. For waterfowl control, limited open-water areas will discourage many species, but treatment requirements will dictate the size and use of these zones. Netting suspended over unavoidable open-water areas can prevent their use for feeding, but this method deviates from the intent to incorporate natural methods of wildlife control.

Wetland wildlife species frequently have home ranges well outside the borders of an individual constructed wetland cell; consequently, they can become a public resource that may need to be protected and promoted for reasons unrelated to their perceived value to constructed wetlands. Although the values of constructed wetlands for wildlife habitat may be subject to public and scientific debate, this topic nonetheless must be considered in all project phases to determine optimum design and management features to promote or discourage the presence of wildlife (Knight, 1997; Worrall et al., 1996).

2.5.3 Mosquito Habitat Controls

Mosquitoes may be integral components of the ecological food web, but mosquitoes generally are considered a pest species. While a constructed wetland's attractiveness to wildlife may be regarded as a benefit to the human community, the potential for breeding mosquitoes can be an obstacle to permitting, funding, and other steps essential to the siting of a constructed wetland.

Several methods of mosquito control can be employed in the planning, construction, and operation of constructed wetlands. Predation is one means. Mosquito fish have been found to be effective in reducing mosquito populations when habitat conditions are optimized by manipulating water levels and when channels are kept free of dead vegetation. Drawdown of water levels aids mosquito fish spawning in spring and provides the fish with better access to mosquito larvae during mosquito breeding season (Dill, 1989). In warm climates, mosquito fish habitat must be monitored for excessive water temperatures and fluctuations in effluent strength and content. Bats and several avian species also are effective predators, but planning and managing optimum conditions have yet to be standardized.

In the planning and construction stages, management of mosquito habitat can be enabled with steep slopes on water channels that reduce standing water area in shallow areas. In contrast to this design is the use of more natural, undulating banks that have been popular in polishing wet-

lands. This natural appearance is more visually appealing but is ineffective for mosquito-control purposes. A channel profile that has been effective in mosquito control is a steep-sided channel flanked by relatively flat aprons leading outward to steep-sided banks (Dill, 1989). This profile allows the facility operator to draw down water levels to the lower channel during the mosquito-breeding season. Figure 2-4 illustrates this design. With standing water eliminated from emergent vegetation in the shallow flanks of the channel, deeper water in the lower channel provides an environment more conducive to mosquito predation by fish species. Flexible drainage capability is essential to this means of control.

Water spray systems also have been used for mosquito control, but such mechanical systems are inconsistent with the passive nature of constructed wetlands, which utilize natural systems to accomplish wastewater treatment and manage ancillary concerns.

Vegetation management is another approach to mosquito control, especially in the absence of water-level control features (Dill, 1989). Taller vegetation especially needs management. Cattails and bulrushes, for example, tend to fall over late in the growing season, which creates conditions favorable for mosquito reproduction in the following growing season, as well as unfavorable conditions for predation by mosquito fish (Martin and Eldridge, 1989). Channels planted with lower-growing vegetation and cleared annually of dead standing stock can reduce mosquito populations and optimize predation, providing that this vegetation imparts the same structural role beneath the water surface.

Larvicide is a proven means of active mosquito control when employed in conjunction with other management techniques. A bacterium (*Bacillus sphaericus*) has been

found effective in reducing culex mosquitoes, one of the most common species in the United States. Tests have indicated that a commercial larvicide containing the bacteria may be capable of eliminating most of the populations of culex in treatment lagoons (WaterWorld, 1996). The concentrated bacteria in powdered form is applied to standing water as a coating on granulated corncobs, which quickly releases protein crystals and bacteria spores to the water surface. Upon ingestion, the bacteria enter mosquito larvae tissues through pores in the gut wall and multiply rapidly, and the infected larvae typically die within two days. However, fully vegetated zones are more difficult to treat than open water zones or lagoons.

2.6 Human Health Concerns

Many studies of constructed wetlands' biological effectiveness and attractiveness to humans for aesthetic and cultural reasons have focused on polishing wetlands that receive secondary effluent, which are outside the focus of this manual. At many of these successful polishing wetlands for tertiary treatment, interpretive centers and signage invite visitors, and boardwalks and naturalists guide them through the outdoor experience. Constructed wetlands that receive primary effluent for secondary treatment, on the other hand, may not be visitor-friendly places, and human visitors may best enjoy them from the periphery for several reasons.

Partially treated wastewater in a constructed wetland for secondary treatment, despite the proven effectiveness of this ecological approach to treatment, presents essentially the same risks to human health as wastewater in primary treatment and lagoons. Risk of dermal contact and possible transmission of disease is equally unappealing in FWS wetlands for secondary treatment as it is in open lagoons. This concern is distinguished from human interaction with

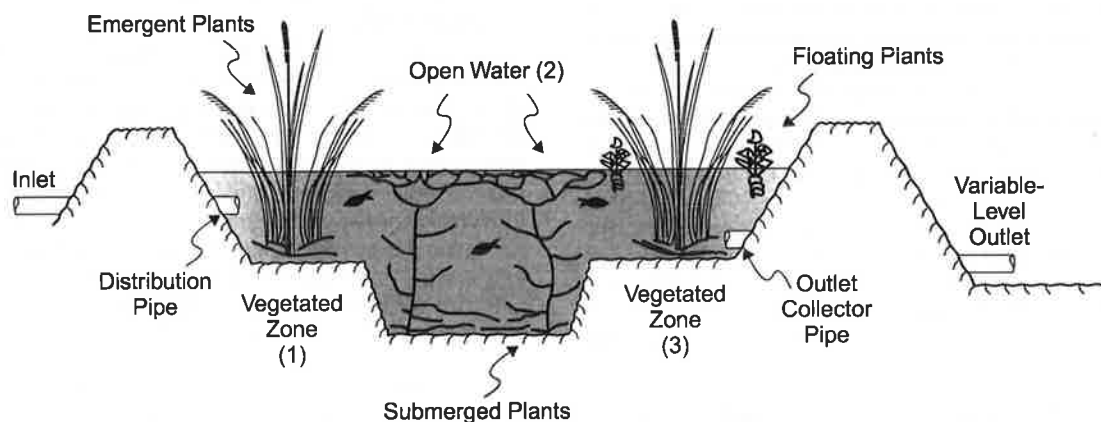


Figure 2-4. Profile of a three-zone FWS constructed wetland cell

polishing systems, where influent wastewater has already met effluent quality requirements which are set by regulatory authorities.

In constructed wetlands receiving primary effluent, human exposure to wastewater is a greater concern at the inlet end of the system, where influent has achieved primary treatment only. Lesser concern for human exposure is warranted at the outlet end, where wastewater has been treated to the quality of secondary treatment or better, which is the quality of wastewater entering the polishing wetlands that have been popular for environmental awareness and education activities.

As a result, humans must be considered an unwanted species in most areas of FWS wetlands treating municipal wastewater to meet secondary treatment (defined as 30 mg/L of BOD and TSS). Nonetheless, constructed wetlands can serve as recreational areas and outdoor laboratories, especially at the outlet end where wastewater has been treated to secondary effluent standards. Management considerations may include the public's access, perceptions, and exposure to health threats (Knight, 1997). To effectively address these concerns, fencing, signage, and other controls must be considered in the proposal stage as well as in design and operation of the system.

Mosquito populations may represent merely an annoyance factor to be managed, as described above, but some species of mosquitoes also carry a health risk that must be addressed. In warmer climates, including the southern United States, the encephalitis mosquito (*Culex tarsalis*) thrives in the extended breeding season provided by constructed wetlands, but water-level manipulation and mosquito fish predation in the two-tiered pond design described previously have been effective in controlling these mosquito populations (Dill, 1989). The two-tiered design allows water levels to be drawn down to concentrate prey species (mosquitoes) in smaller areas for more efficient consumption by predators (mosquito fish).

Most of the health concerns described above do not apply to VSB systems, in which wastewater typically is not exposed at the land surface.

2.7 On-site System Applications

On-site constructed wetland systems may also be applied to wastewater treatment and disposal at individual properties. On-site constructed wetlands generally utilize the same technologies as the municipal VSB systems described in this manual, and they share with municipal systems the advantages of cost-effectiveness and low-maintenance requirements. However, on-site constructed wetlands are distinguished typically by final effluent discharge to soils instead of surface water. For purposes of this discussion, on-site constructed wetland systems treat septic tank effluent, or primary effluent, in small-scale VSB systems for subsurface disposal to soils.

On-site constructed wetlands also differ from municipal systems in scale. On-site constructed wetlands typically

occupy only a few hundred square feet. Municipal VSB systems may serve hundreds of residential, commercial, and industrial properties, while on-site systems would serve a single home or several residences in a cluster.

An on-site VSB system typically consists of a lined VSB that receives primary effluent from a septic tank, and in some designs, a second VSB that receives effluent from the upstream VSB system. The second VSB can be unlined to allow treated wastewater to infiltrate to soil for disposal. Variations of this treatment train include use of supplemental absorption trenches to facilitate soil absorption and direct surface discharge with or without subsequent disinfection. Each VSB typically is planted with wetland vegetation.

Applied studies and research experiments of on-site constructed wetland systems have shown adequate treatment performance for most wastewater constituents, including BOD, TSS, and fecal coliforms, with variations in performance for removal of ammonia nitrogen (Burgan and Sievers, 1994; Huang et al., 1994; Johns et al., 1998; Mankin and Powell, 1998; Neralla et al., 1998; White and Shirk, 1998).

2.8 Related Aquatic Treatment Systems

Several types of aquatic treatment systems have been constructed to treat municipal and other wastewaters, and most of these systems fall outside the definition of constructed wetlands discussed in this manual. These other types of systems are briefly described to provide the reader with additional background and references to source material.

Polishing wetlands have been used also to remove trace metals, including cadmium, chromium, iron, lead, manganese, selenium, and zinc in a variety of situations. The primary removal mechanism for metals in wastewater appears to be sedimentation. Plant uptake results in deposition of metals to soil via plant roots and requires harvest of plants to partially remove metals from the system. In some cases, however, effluent concentrations of metals have exceeded influent levels, apparently due to evaporation of wastewater.

One proprietary treatment system, which among its many manifestations has used both FWS-like and VSB-like treatment units as part of its treatment train, is known as the Advanced Ecologically Engineered System (AEES), or "Living Machine." This system incorporates conventional treatment system components, including sedimentation/anaerobic bioreactors, extended aeration, clarifiers, fixed-film reactors, and a final clarifier, sometimes with a VSB for polishing, in a greenhouse setting. The AEES was applied to four demonstration projects funded with federal grants. The four projects underwent evaluation of treatment performance for various wastewater types and settings (e.g., raw wastewater in a moderate climate, raw wastewater at higher flow rates in a colder climate, in situ water-quality improvements to pond water, and polishing

of secondary effluent). One of the demonstration projects also was evaluated by an independent firm under contract to the U.S. EPA (EPA, 1997b). Results of performance evaluations indicated that wastewater treatment met performance goals for certain wastewater constituents; other goals were unmet. Although this technology is presented by its developers as a type of natural system, the use of wetland plants appears to influence aesthetics more than treatment performance. The reader is directed to other sources for further information (EPA, 1993b; EPA, 1997b; Living Technologies, 1996; Reed et al., 1995; Todd and Josephson, 1994).

Floating macrophyte systems rely only partially on treatment processes provided by wetlands and require mechanized components to achieve the intended treatment performance. Larger duckweed systems and water hyacinth systems utilize mechanical systems to remove floating macrophytes. Both have been employed to treat wastewater by removing some of the wastewater constituents, primarily BOD and TSS. In both systems, removal of plants usually requires additional mechanical systems for drying, disposal, and other residuals handling (Zirschky and Reed, 1988).

2.9 Frequently Asked Questions

1. What are constructed wetlands?

The term "constructed wetlands" refers to a technology designed to employ ecological processes found in natural wetland ecosystems. These systems utilize wetland plants, soils, and associated microorganisms to remove contaminants from wastewater. As with other natural biological treatment technologies, wetland treatment systems are capable of providing additional benefits. They are generally reliable systems with no anthropogenic energy sources or chemical requirements, a minimum of operational requirements, and large land requirements. The treatment of wastewater using constructed wetland technology also provides an opportunity to create or restore wetlands for environmental enhancement, such as wildlife habitat, greenbelts, passive recreation associated with ponds, and other environmental amenities.

2. What are wetland treatment systems?

The term "wetland treatment system" generally refers to two types of passive treatment systems. One type of system is a free water surface (FWS) constructed wetland, which is a shallow wetland with a combination of emergent aquatic plants (cattail, bulrush, reeds, and others), floating plants (duckweed, water hyacinth, and others), and submergent aquatic plants (sago pondweed, widgeon grass, and others). A FWS wetland may have open-water areas dominated by submergent and floating plants, or it may contain islands for habitat purposes. It may be lined or unlined, depending on regulatory and/or performance requirements. These systems exhibit com-

plex aquatic ecology, including habitat for aquatic and wetland birds.

A second type of system is termed "vegetated submerged bed (VSB)" and is known to many as a subsurface flow wetland. A VSB is not an actual wetland because it does not have hydric soils. Emergent wetland plants are rooted in gravel, but wastewater flows through the gravel and not over the surface. This system is also shallow and contains sufficiently large gravel to permit long-term subsurface flow without clogging. Roots and tubers (rhizomes) of the plants grow into pore spaces in the gravel. Most current data indicate that these systems perform as well without plants as with plants; as a result, wetland ecology is not a critical factor in VSB systems.

3. Are constructed wetlands reliable? What do they treat?

Constructed wetlands are an effective and reliable water reclamation technology if they are properly designed, constructed, operated, and maintained. They can remove most pollutants associated with municipal and industrial wastewater and stormwater and are usually designed to remove contaminants such as biochemical oxygen demand (BOD) and suspended solids. Constructed wetlands also have been used to remove metals, including cadmium, chromium, iron, lead, manganese, selenium, zinc, and toxic organics from wastewater.

4. How does a constructed wetland treat wastewater?

A natural wetland acts as a watershed filter, a sink for sediments and precipitates, and a biogeochemical engine that recycles and transforms some of the nutrients. A constructed wetland performs the same functions for wastewater, and a constructed wetland can perform many of the functions of conventional wastewater treatment trains (sedimentation, filtration, digestion, oxidation, reduction, adsorption, and precipitation). These processes occur sequentially as wastewater moves through the wetland, with wastewater constituents becoming comingled with detritus of marsh plants.

5. What is the difference between treatment and enhancement wetlands?

Constructed wetlands generally are designed to treat municipal or industrial effluents as well as stormwater runoff. Enhancement marshes, or polishing wetlands, are designed to benefit the community with multiple uses, such as water reclamation, wildlife habitat, water storage, mitigation banks, and opportunities for passive recreation and environmental education. Both types of wetland systems can be designed as separate systems, or

important attributes of each can be integrated into a single design with multiple treatment and enhancement objectives.

6. Can a constructed wetland be used to meet a secondary effluent standard?

Both FWS and VSB constructed wetlands can be used to meet a 30/30 mg/L BOD and TSS discharge standard. It is not advisable to put raw wastewater into a constructed wetland.

7. Can a constructed wetland be used to meet an advanced secondary/tertiary discharge standard?

With sufficient pretreatment and wetland area, FWS constructed wetlands can meet discharge standards of less than 10 mg/L BOD, TSS, and TN on a monthly average basis. Many examples of FWS wetland systems meeting these standards on a monthly average basis can be found in the United States (EPA, 1999). VSB systems have been used extensively in England for polishing secondary effluents and treating effluent from combined sanitary and storm sewers. In the U.S., they have generally not performed well in consistently reaching advanced treatment goals with primary treatment influent.

8. How much area is required for constructed wetlands?

As a general rule, a constructed wetland receiving wastewater with greater degrees of pretreatment (for example, primary clarification, oxidation pond, trickling filter, etc.) requires less area than a constructed wetland receiving higher-strength wastewater. Historically, constructed wetlands designers have employed from <2 to over 200 acres/MGD (4 to 530 L/m²-d). However, there is no generic answer to the question since it depends on the effluent criteria to be met and buffer areas required.

9. Do these systems have to be lined?

The requirement for liners in constructed wetlands depends on each state's regulatory requirements and/or the characteristics of surface and subsurface soils. In a general sense, if soils are porous (e.g., sands), well-drained, and contain small amounts of loams, clays, and silts, lining is likely to be a requirement for constructed wetlands. On the other hand, if soils are poorly drained and composed mostly of clays, then lining might not be required. These systems would tend to produce a layer of peat on the bottom that would reduce infiltration with time. The concept of a "leaky wetland," which may take advantage of natural processes to purify wastewater as it moves downward through soil to recharge the ground water, may be considered a potential benefit in certain areas.

10. What is the role of the plants in constructed wetlands?

In FWS constructed wetlands, plants play several essential roles. The most important function of emergent and floating aquatic plants is providing a canopy over the water column, which limits production of phytoplankton and increases the potential for accumulation of free-floating aquatic plants (e.g., duckweed) that restrict atmospheric reaeration. These conditions also enhance reduction of suspended solids within the FWS constructed wetland. Emergent plants play a minor role in taking up nitrogen and phosphorus. The effect of litter fall from previous growing seasons as it moves through the water column and eventually decomposes into humic soil and lignin particles may be significant in terms of effluent quality.

The role of plants in VSB systems is not clear. Initially it was believed that translocation of oxygen by plants was a major source of oxygen to microbes growing in the VSB media, and therefore plants were critical components in the process. However, side-by-side comparisons of planted and unplanted systems have not confirmed this belief. Nevertheless, planted VSB systems are more desirable aesthetically than unplanted horizontal rock-filter systems, and plants do not appear to hinder performance of VSB systems.

11. How much time is needed for a constructed wetland to become fully operational and meet discharge requirements?

For FWS wetland systems, several growing seasons may be needed to obtain the optimum vegetative density necessary for treatment processes. The length of this period is somewhat dependent on the original planting density and the season of the initial planting. Effluent quality has been observed to improve with time, suggesting that vegetation density and accumulated plant litter play an important role in treatment effectiveness.

VSB systems also require more than one growing season to achieve normal wetland plant densities. However, the time required for VSB systems to become fully operational is considerably less than FWS systems because of the minor role of plants in the treatment process. Development of the microbial biomass in the media of a VSB system typically requires from three to six months.

12. How long can a FWS wetland operate before accumulated plant material and settled solids need to be removed?

FWS wetland systems receiving oxidation pond effluent may operate for 10 to 15 years without the need to remove accumulated litter and settled

nondegradable influent solids. Treatment capacities of these wetlands have not shown a decrease in treatment effectiveness with time. However, it is assumed that further experience will reveal that there is a finite period of accumulation that will result in the need to remove solids. In both types of systems, the bulk of the solids accumulation occurs at the influent end of the system. As a result, solids may need to be removed from only a portion of the system that may be as small as 10 to 25% of the surface area.

13. How much effort is required to operate and maintain a constructed wetland?

These systems require a minimum of operational control. Monthly or weekly inspection of weirs and weekly sampling typically are required at the effluent end, and periodic sampling between multiple cells is recommended.

Maintenance of constructed wetlands generally is limited to the control of unwanted aquatic plants and control of disease vectors, especially mosquitoes. Harvesting of plants generally is not required, but annual removal or thinning of vegetation or replanting of vegetation may be needed to maintain flow patterns and treatment functions.

Effective vector control can be achieved by appropriately applying integrated pest management practices, such as introducing mosquito fish or providing habitat for mosquito-eating birds and bats. Bi-monthly monitoring of mosquito larvae and pupae and applications of larvicides may be required on an as-needed basis.

Sediment accumulation typically is not a problem in a well-designed and properly operated constructed wetland, thus partial dredging is required only rarely.

These tasks would require approximately one day per week of labor for a wetland system treating a flow of one million gallons per day (MGD) (3,880 m³/d) or less, and monitoring may be the most demanding task.

14. Do constructed wetlands produce odors?

Conventional wastewater treatment processes produce odors mostly associated with anaerobic decomposition of human waste and food waste found in sewage. These odors usually are concentrated in areas of small confinement and point discharges, like influent pump stations, anaerobic digesters, and sludge-handling processes. Wetlands, in contrast, incorporate normal processes of decomposition over a relatively large area, potentially diluting odors associated with the natural decomposition of plant material, algae, and other biological solids. How-

ever, wetland treatment systems receiving septic tank and primary effluents can release anaerobic odors around the inlet piping, and both types are generally anaerobic, which makes odor generation a major operational concern.

15. Are mosquitoes a potential problem with constructed wetlands? If so, how are they managed?

Mosquitoes generally are not a problem in properly designed and operated VSB systems. However, mosquitoes can be a problem in FWS constructed wetlands. If a FWS wetland is designed with sufficient open water (40 to 60% of the surface area) to permit effective control with mosquito fish, and inlet and outlet weirs are placed to allow level control and drainage of wetland cells, the potential for mosquito populations to thrive is reduced. This latter concept provides for isolation of various wetland cells to allow them to be drained and/or to allow predators and mosquitoes to become concentrated in pools and channels.

Along with these physical factors, the development of a balanced ecosystem that includes other aquatic invertebrates (beetles), aquatic insects (dragon flies and damsel flies), fish (top-feeding minnows, sticklebacks, gobies, and others), birds (swallows, ducks, and others), and mammals (bats) will help maintain acceptable levels of mosquitoes. Under these conditions, the mosquito is simply a component in a balanced food web. If an imbalance develops, then intervention with certain biological and chemical agents may be required.

A successful intervention method has been the use of Bti, a bacterium spore that interferes with development of the adult. In essence, Bti kills the larva via physical actions. Several applications over the mosquito season are needed to interfere with the mosquito's natural growth cycle, which may be three to four months in length. Other larvicides, such as methoprene, are chemicals that are not selective for certain stages of mosquitoes' life cycle. Adulticides also are not selective for life cycles but could be used at critical times.

In general, proper design that supports a healthy wetland ecosystem produces conditions that maintain sufficiently low mosquito populations.

16. What is the present level of application of this technology?

As of late 1999, more than 200 communities in the United States were reported to be utilizing constructed wetlands for wastewater treatment. Most of these communities use wetlands for polishing lagoon effluent. In addition, communities in a wide range of sizes use this technology, including large cities such as Phoenix, Arizona, and Orange

County, Florida. For the most part, however, FWS technology has been utilized by small- to medium-sized communities ranging from 5,000 to 50,000 in population.

Even though constructed wetlands for municipal wastewater treatment have been around for as long as 40 years, there have been widespread problems in their performance with respect to nitrogen transformations and removal as well as phosphorus removal (WRC, 2000). This manual has been created to help future owners and designers avoid unrealistic expectations from these systems.

17. Can these systems operate at elevations other than sea level?

FWS and VSB systems are found in a wide range of elevations extending, for example, from the desert Southwest to New England, and from the southeast United States to the Rocky Mountains and Pacific coast regions. The common wetland plants used in these systems are found in all areas of the United States and Canada. There is no inherent biological or ecological basis for these types of systems to not work in the normal range of physiographic conditions in the United States, Canada, and Mexico.

18. Can constructed wetlands work in cold temperatures?

Constructed wetlands are found in a wide range of climatological settings, including cold climates where ice forms on the surface for four to six months of the year. For example, these systems are found in Canada, North Dakota, Montana, Vermont, Colorado, and other cold-climate areas. Special considerations must be included in the design of these systems for the formation of an ice layer and the effect of cold temperatures on mechanical systems, such as the influent and effluent works. The absence of living plants that have died back for the winter and the presence of a layer of ice approximately 0.5 to 1.0 ft. thick have not been shown to severely affect the secondary treatment capabilities of these systems. Nitrogen transformation and removal is, however, impaired during very cold periods.

19. Can you receive full treatment benefits from a constructed wetland that also provides ancillary benefits such as wildlife habitat?

Multiple benefits can accrue from a FWS constructed wetland if it is properly sited and designed. For example, FWS wetlands that have a significant portion of surface area occupied by submergent aquatic plants and deeper water have been found to produce higher-quality effluent and provide greater habitat value than other configurations. This

open space is used by aquatic fowl for feeding, access to refugia, and as a source of fresh water. The same submerged aquatic plants that provide wastewater treatment also serve as a food source for aquatic birds and mammals.

Because reduced human health risk is associated with tertiary treatment or "polishing" wetlands, they have commonly enjoyed full recreational access to the FWS systems, but they provide minimal removal of several key pollutants in comparison to the treatment wetlands that are the focus of this manual. Therefore, human access to these systems entails greater health risks because the wastewater is actively being treated. The wildlife and other natural ecological populations may be equally abundant in these systems as in the polishing systems, but human access may be restricted, at least in the inlet environs.

The potential for ancillary benefits is reduced with VSB systems. Depending on its size and degree of vegetation, a VSB system could provide wildlife habitat. VSB wetlands also can be used for environmental education and awareness activities.

2.10 Glossary

Abiotic Nonbiological processes or treatment mechanisms in a constructed wetland.

Adsorption Adherence by chemical or physical bonding of a pollutant to a solid surface.

Adventitious roots provide a competitive advantage to a plant by growing from stems into the surrounding air (around terrestrial plants) or water (around aquatic plants) before entering the soil substrate to provide additional uptake or absorption directly from the surrounding medium.

Aerenchymous tissues in aquatic plants provide for transfer of gases within a plant. In wastewater treatment systems, emergent aquatic plants rely on aerenchymous tissues for transfer of oxygen to their roots.

Aerobic processes in wastewater treatment systems take place in the presence of dissolved oxygen.

Algae are single-celled to multicelled organisms that rely on photosynthesis for growth. Most algae are classified as plants.

Anaerobic processes in wastewater treatment systems take place in the absence of dissolved oxygen and instead rely on molecular oxygen available in decomposing compounds.

Aspect ratio The length of a constructed wetland divided by its width (L/W).

Atmospheric reaeration introduces atmospheric oxygen into the water at the water's surface, which provides dissolved oxygen to the aquatic environment.

Autotrophic Types of reactions that generally require only inorganic reactants; for example, nitrification.

Biochemical oxygen demand (BOD) is the demand for dissolved oxygen that decomposition of organic matter places on a wastewater treatment process. BOD as expressed in milligrams per liter (mg/L) is used as a measure of wastewater organic strength and as a measure of treatment performance. This constituent is represented throughout the text of this manual as "BOD," which stands for the U.S. standard 5-day BOD test result.

Biomass is the total amount of living material, including plants and animals, in a unit volume.

Biotic is a term which implies microbiological or biological mechanisms of treatment.

BOD removal is the lowering of demand for dissolved oxygen required for biological decomposition processes in the water column; hence, BOD removal can be accomplished by biological decomposition in open-water zones and by flocculation and sedimentation in fully vegetated zones and in VSBs.

Bulrush is the common name for a number of plants of the genus *Scirpus* found in wetlands. Several species of bulrush commonly used in constructed wetlands thrive in the wide range of environmental conditions in constructed wetlands, including varying levels of water depth and quality. The large, terete bulrush species include *S. validus*, *S. californicus*, and *S. acutus*, all of which form dense stands with large numbers of round-sectioned stems that maintain an upright posture for one or more years. Other species of *Scirpus* include the three-square varieties, such as *S. americanus (olynei)*, *S. fluviatilis*, and *S. robustus*, which offer tolerance to salinity, a variety of color shades, and attractiveness to various animal species.

Canopy Uppermost or tallest vegetation in a plant community.

Cattail is the common name for a number of plants of the genus *Typha* that are common in constructed wetlands in the United States, with at least three species predominant: *T. latifolia*, *T. domingensis*, and *T. angustifolia*. Along with their hybridized forms, these species occupy numerous water-depth and water-quality niches within constructed wetlands. The wetland designer is advised to consult local botanists and geographic references to determine which local cattail species or hybrid is best adapted to the specific water quality, water depth, and substrate planned for a constructed wetland.

Common reed (*Phragmites*) probably is the most widely used plant in constructed wetlands on a worldwide basis, but it typically is not used in the United States. Although this plant has excellent growth characteristics in very shallow constructed wetlands, it is an invasive species in some natural wetlands, and its transport and intentional introduction to some localities are discouraged. Common reed

is considered to offer little value as food or habitat for wetland wildlife species (Thunhorst, 1993).

Constructed wetlands are wastewater treatment systems that rely on physical, chemical, and biological processes typically found in natural wetlands to treat a relatively constant flow of pretreated wastewater.

Deciduous Woody plants that shed their leaves in cold seasons.

Dentrification Biotic conversion of nitrate-nitrogen to nitrogen gases.

Detritus Loose, dead leaves and stems from dead vegetation.

Dike A wall of mounded soil that contains or separates constructed wetlands from surrounding areas. Dissolved oxygen (DO) is required in the water column of a wastewater treatment system for aerobic biochemical processes that take place in constructed wetlands.

Dominant plant species The plant species that exerts a controlling influence on the function of the entire plant community.

Duckweed Duckweed naturally moves on a large water surface by movement induced by wind action unless it is protected from the wind and held in place by dense stands of emergent plants (e.g., macrophytes) or artificial barriers. In FWS systems, this results in dense growths of duckweed within the fully vegetated zones. Duckweed effectively seals the water surface and prevents atmospheric reaeration. This action combined with the inherent oxygen demand of the incompletely treated municipal wastewater results in anaerobic conditions in these fully vegetated zones.

Emergent herbaceous wetland plants grow rooted in the soil, with plant structures extending above the surface of the water. These plants are herbaceous by virtue of their relatively decomposable (leafy) plant structures, but they also have sufficient internal structure to maintain their upright growth, even without the support of surrounding waters. Most emergent wetland plants grow with or without the presence of surface water; however, they generally grow in shallow water near the banks of a water body.

Emergent vegetation (see macrophytes).

Evapotranspiration Loss of water to the atmosphere through water surface and vegetation.

Exotic species A plant not indigenous to the region.

Fecal coliform A common measure for pathogenicity of wastewater. This analytical test reveals the number of these types of organisms in counts/100 milliliters (#/100mL)

Filtration is the process of filtering influent solids from the wastewater and typically is provided by plant stems and leaves and other vegetation in the water column.

Floating aquatic plants are commonly found in FWS systems, including water hyacinth (*Eichhornia crassipes*), duckweed (*Lemna spp.*, *Spirodela spp.*, and *Wolffia spp.*), water fern (*Azolla caroliniana* and *Salvinia rotundifolia*), and water lettuce (*Pistia stratiotes*). Also common are rooted plants growing in a floating form, including pennywort (*Hydrocotyle spp.*), water lily (*Nymphaea spp.*), frog's bit (*Limnobium spongia*), spatterdock (*Nuphar spp.*), and pondweed (*Potamogeton spp.*).

Floating aquatic systems are in essence shallow basins covered with floating aquatic plants. One type of plant that can remain in place is the water hyacinth, but it is very sensitive to other than tropical temperatures and is considered to be an invasive species. Duckweed has been held in place with artificial barriers in these types of systems.

Flocculation is the process of very small particles of matter clumping together to reach a collectively larger size. In wastewater treatment processes, flocculation typically agglomerates colloidal particulates into larger, settleable solids that are then removed by sedimentation processes.

Free water surface (FWS) wetlands are constructed wetlands that provide wastewater treatment through flocculation and sedimentation during the flow of wastewater through stands of aquatic plants growing in shallow water. In some FWS wetlands, there are also open areas where aerobic bio-oxidation complements the physical removal processes. FWS systems resemble natural wetlands in function and appearance. FWS systems have also been termed "surface flow systems."

Function refers to the purpose, role, or actions expected of constructed wetlands in the process of wastewater treatment. Function is expressed in terms of expected results, such as nutrient uptake, removal of TSS and BOD, maintenance of dissolved oxygen in open water zones, and reduction of wastewater constituents to acceptable levels, waterfowl habitat, and water storage.

Habitat value The suitability of an area to support a given species.

Herbaceous Plant material that has no woody parts.

Herbivores are members of the animal kingdom that consume plant matter.

Hydric soils, or wetland soils, exhibit distinct chemical and physical changes that result from periodic inundation and saturation. Flooding and subsequent decomposition and oxidation of soil chemicals typically result in anaerobic soil conditions.

Hydrophyte Any plant growing in a soil that is deficient in oxygen.

Indigenous species Species of plants that are native to an area.

Inorganics Compounds that do not contain organic carbon.

Lagoons are also called stabilization ponds, oxidation ponds, etc. In conventional wastewater treatment systems, they typically are used to provide intermediate treatment of wastewater through a variety of physical, chemical, and biological processes.

Limiting nutrient is the nutrient that controls a particular plant's growth. When present in insufficient amounts relative to a given plant's needs, a limiting nutrient limits that plant's growth.

Limnetic The open water zone of a FWS system where light can penetrate to induce photosynthesis.

Macrophytes are plants that are readily visible to the unaided eye and include vascular or higher plants. Vascular plants include mosses, ferns, conifers, monocots, and dicots. Macrophytes also may be categorized by a variety of ecological growth forms.

Marsh A common term applied to treeless wetlands.

Microbes or **microorganisms** are microscopic organisms (only viewed with a microscope), such as bacteria, protozoans, and certain species of algae, which are responsible for many of the biochemical transformations necessary in wastewater treatment processes.

Nitrification Biotic conversion of ammonium nitrogen to nitrite and nitrate-nitrogen.

Nuisance species Plants that detract from or interfere with the designated purpose(s) of constructed wetlands.

On-site constructed wetland systems are wastewater systems for treatment and disposal at the site where wastewater is generated. For example, a residential septic system is an on-site system.

Organics Compounds that contain organic carbon (also volatile solids).

Oxygen demand Generally expressed through relatively high BOD concentrations, the property of municipal wastewater that removes dissolved oxygen from the water column.

Photosynthesis is the conversion of sunlight into organic matter by plants through a process of combining carbon dioxide and water in the presence of chlorophyll and light, which releases oxygen as a by-product.

Phytoplankton are algae that are microscopic in size which float or drift in the upper layer of the water column and depend on photosynthesis and the presence of phosphorus and nitrogen in the water.

Pneumatophores are structures that provide air channels for emergent plants growing in water environments.

Polishing wetlands are designed to provide tertiary treatment to secondary effluent to meet performance standards

required by National Pollutant Discharge Elimination System (NPDES) permits. Design considerations for polishing wetlands are outside the scope of this manual.

Primary effluent is the product of primary treatment of wastewater that typically involves settling of solids in a containment structure, such as a septic tank, settling pond, or lagoon.

Primary production is the production of biomass (organic carbon) by plants and microscopic algae, typically through photosynthesis, as the first link in the food chain.

Primary treatment of wastewater is a settling process for removal of settleable solids from wastewaters.

Rhizome Root-like stem that produces roots and stems to propagate itself in a surrounding zone.

Secondary effluent is wastewater that has undergone secondary treatment and is discharged to the environment or receives further treatment in tertiary treatment processes.

Secondary treatment continues the process begun in primary treatment by removing certain constituents, such as biochemical oxygen demand (BOD) and total suspended solids (TSS) from primary effluent to prescribed treatment levels; typically, 30 mg/L in the United States.

Sediment Organic and mineral particulates that have settled from the overlying water column (also sludge).

Seepage Loss of water from a constructed wetland to the soil through infiltration below the system. Senescence is the phase at the end of a plant's life that leads to death and, finally, decay.

Solar insolation refers to the amount of solar radiation that reaches the constructed wetland. Solar radiation in the summer months may play an important role in photosynthesis in open-water zones of a FWS system.

Standing biomass in a constructed wetland is the total amount of plant material that stands erect. This term typically is used as "dead standing biomass" to refer to dead, standing plants, in contrast to green plants and plant litter composed of broken and fallen dead plant parts.

Structure refers to the form and amount of living and nonliving components of an ecosystem. For example, emergent vegetation provides the structure to perform wetland functions. Wetland structure is expressed in qualitative terms such as species of flora and fauna, or type of wetland such as marsh, bog, or bottomland forest.

Submerged aquatic plants or submergent vegetation are rooted plants that grow in open water zones within the water column of an aquatic environment (compare to emergent aquatic plants) and provide dissolved oxygen for aerobic biochemical reactions. They lie below the water surface, except for flowering parts in some species.

Subsurface flow (SF) wetlands (see vegetated submerged bed (VSB) systems).

Tertiary treatment (see polishing wetlands).

Total nitrogen (TN) is the sum of all the forms of nitrogen, including nitrate, nitrite, ammonia, and organic nitrogen in wastewater, and is typically expressed in milligrams per liter (mg/L).

Total phosphorus (TP) is a measure of all forms of phosphorus in wastewater, typically expressed in milligrams per liter (mg/L).

Total suspended solids (TSS) are particulate matter in wastewater consisting of organic and inorganic matter that is suspended in the water column. The numeric value is provided by specific analytical test. Typically, municipal wastewaters include the settleable solids and some portion of the colloidal fraction.

Vascular plant Plant that readily conducts water, minerals and foods throughout its boundaries.

Vegetated submerged bed (VSB) systems provide wastewater treatment in filter media that is not directly exposed to the atmosphere but may be slightly influenced by the roots of surface vegetation. VSB systems also have been termed subsurface flow (SF) wetlands, rock reed filters, submerged filters, root zone method, reed bed treatment systems, and microbial rock plant filters. In this manual, the term "vegetated submerged bed systems" is used because gravel beds rather than hydric soils are the support media for wetland plants; as a result, the systems are not truly wetlands.

Vegetative reproduction is the process of asexual reproduction, in which new plants develop from roots, stems, and leaves of the parent plant.

Wastewater treatment is the process of improving the quality of wastewater. The term can refer to any parts or all parts of the process by which raw wastewater is transformed through biological, biochemical, and physical means to reduce contaminant concentrations to prescribed levels prior to release to the environment. A wastewater treatment process typically consists of primary, secondary, and tertiary treatment.

Wetland hydraulics refers to movement of water through constructed wetlands, including volumes, forces, velocities, rates, flow patterns, and other characteristics.

Woody plants are plants that produce bark and vascular structures that are not leafy in nature. Woody plants have trunks, stems, branches, and twigs that allow them to occupy a greater variety of available niches than herbaceous plants can occupy. General terms that describe categories of woody plants found in wetlands are shrubs, trees (canopy or subcanopy), and woody vines.

Wrack Plant debris carried by water.

Zooplankton Microscopic and small animals that live in the water column.

2.11 References

- Arizona Department of Environmental Quality (ADEQ). 1995. Arizona guidance manual for constructed wetlands for water quality improvement. Prepared by R.L. Knight, R. Randall, M. Girts, J.A. Tress, M. Wilhelm, and R.H. Kadlec. ADEQ TM 95-1.
- Armstrong, W. 1978. Root aeration in the wetland environment. In: D.D. Hook and R.M.M. Crawford (eds.) *Plant life in anaerobic environments*. Ann Arbor, MI: Ann Arbor Science, Chapter 9, pp. 269–297.
- Bavor, H.J., D.J. Roser, P.J. Fisher, and I.C. Smalls. 1989. Performance of solid-matrix wetland systems viewed as fixed-film bioreactors. In: D.A. Hammer (ed.) *Constructed wetlands for wastewater treatment, municipal, industrial, and agricultural*. Chelsea, MI: Lewis Publishers, Chapter 39k, pp. 646–656.
- Burgan, M.A. and D.M. Sievers. 1994. On-site treatment of household sewage via septic tank and two-stage submerged bed wetland. In: *Proceedings of the Seventh International Symposium on Individual and Small Community Sewage Systems*. American Society of Agricultural Engineers, Atlanta, GA: pp. 77–84.
- Burgoon, P.S., K.R. Reddy, and T.A. DeBusk. 1989. Domestic wastewater treatment using emergent plants cultured in gravel and plastic substrates. In: D.A. Hammer (ed.) *Constructed wetlands for wastewater treatment, municipal, industrial, and agricultural*. Chelsea, MI: Lewis Publishers, Chapter 38f, pp. 536–541.
- Dennison, M.S. and J.F. Berry. 1993. *Wetlands: guide to science, law, and technology*. Park Ridge, NJ: Noyes Publications, 439 pp.
- Dill, C.H. 1989. Wastewater wetlands: user friendly mosquito habitats. In: D.A. Hammer (ed.) *Constructed wetlands for wastewater treatment, municipal, industrial, and agricultural*. Chelsea, MI: Lewis Publishers, Chapter 39m, pp. 664–667.
- Feierabend, J.S. 1989. Wetlands: the lifeblood of wildlife. In: D.A. Hammer (ed.) *Constructed wetlands for wastewater treatment, municipal, industrial, and agricultural*. Chelsea, MI: Lewis Publishers, Chapter 7, pp. 107–118.
- Friend, M. 1985. Wildlife health implications of sewage disposal in wetlands. In: P.J. Godfrey, E.R. Kaynor, S. Pelczarski, and J. Benforado (eds.) *Ecological considerations in wetlands treatment of municipal wastewaters*. New York, NY: Van Nostrand Reinhold, Chapter 17, pp. 262–269.
- Gearheart, R.A., F. Klopp, and G. Allen. 1989. Constructed free surface wetlands to treat and receive wastewater: pilot project to full scale. In: D.A. Hammer (ed.) *Constructed wetlands for wastewater treatment, municipal, industrial, and agricultural*. Chelsea, MI: Lewis Publishers, Chapter 8, pp. 121–137.
- Hammer, D.A. 1992. *Creating freshwater wetlands*. Boca Raton, FL: Lewis Publishers, 298 pp.
- Huang, J., R.B. Renau, Jr., and C. Hagedorn. 1994. Constructed wetlands for domestic wastewater treatment. In: *Proceedings of the Seventh International Symposium on Individual and Small Community Sewage Systems*. American Society of Agricultural Engineers, Atlanta, GA, pp. 66–76.
- Johns, M.J., B.J. Lisidar, A.L. Kenimer, and R.W. Weaver. 1998. Nitrogen fate in a subsurface flow constructed wetland for on-site wastewater treatment. In: *Proceedings of the Eighth National Symposium on Individual and Small Community Sewage Systems*. American Society for Agricultural Engineers, Orlando, FL, pp. 237–246.
- Kadlec, R.H. and R.L. Knight. 1996. *Constructed wetlands*. Boca Raton, FL: Lewis Publishers, 893 pp.
- Kadlec, R.H., D.A. Hammer, and M.A. Girts. 1990. A total evaporative constructed wetland treatment system. In: P.F. Cooper and B.C. Findlater (eds.) *Constructed wetlands in water pollution control*. Oxford, UK: Pergamon Press, pp. 127–138.
- Kent, D.M. 1994. *Applied wetlands science and technology*. Boca Raton, FL: Lewis Publishers, 436 pp.
- Knight, R.L. 1992. Ancillary benefits and potential problems with the use of wetlands for nonpoint source pollution control. *Ecological Engineering*, 1:97–113.
- Knight, R.L. 1997. Wildlife habitat and public use benefits of constructed wetlands. In: R. Haberl, R. Perfler, J. Laber, and P. Cooper (eds.) *Wetland systems for water pollution control 1996*. *Water Science & Technology* 35(5). Oxford, UK: Elsevier Science Ltd., pp. 35–43.
- Kroodsma, D.E. 1978. Habitat values for nongame wetland birds. In: P.E. Greeson, J.R. Clark, and J.E. Clark (eds.) *Wetland functions and values: the state of our understanding*. Minneapolis, MN: American Water Resources Association, pp. 320–326.
- Living Technologies, Inc. 1996. Interim performance report for the South Burlington, Vermont "Living Machine," January–August 1996. Burlington, VT: Living Technologies, Inc., September 1996.

- Majumdar, S.K., R.P. Brooks, F.J. Brenner, and R.W. Tiner (eds.) 1989. *Wetlands ecology and conservation: Emphasis in Pennsylvania*. Easton, PA: The Pennsylvania Academy of Science, 394 pp.
- Mankin, K.R. and G. M. Powell. 1998. Onsite rock-plant filter monitoring and evaluation in Kansas. In: *Proceedings of the Eighth National Symposium on Individual and Small Community Sewage Systems*. American Society for Agricultural Engineers, Orlando, FL, pp. 228–236.
- Marble, A.D. 1992. *A guide to wetland functional design*. Boca Raton, FL: Lewis Publishers, 222 pp.
- Martin, C.V. and B.F. Eldridge. 1989. California's experience with mosquitoes in aquatic wastewater treatment systems. In: D.A. Hammer (ed.) *Constructed wetlands for wastewater treatment, municipal, industrial, and agricultural*. Chelsea, MI: Lewis Publishers, pp. 393–398.
- McAllister, L.S. 1992. *Habitat quality assessment of two wetland treatment systems in Mississippi—A pilot study*. EPA/600/R-92/229. U.S. Environmental Protection Agency, Environmental Research Laboratory, Corvallis, OR. November 1992.
- McAllister, L.S. 1993a. *Habitat quality assessment of two wetland treatment systems in the arid west—A pilot study*. EPA/600/R-93/117. U.S. Environmental Protection Agency, Environmental Research Laboratory, Corvallis, OR. July 1993.
- McAllister, L.S. 1993b. *Habitat quality assessment of two wetland treatment systems in Florida—A pilot study*. EPA/600/R-93/222. U.S. Environmental Protection Agency, Environmental Research Laboratory, Corvallis, OR. November 1993.
- Merritt, A. 1994. *Wetlands, industry & wildlife: A manual of principles and practices*. Gloucester, UK: The Wildfowl Trust, 182 pp.
- Mitsch, W.J. and J.G. Gosselink. 1993. *Wetlands*. 2d ed. New York, NY: Van Nostrand Reinhold, 722 pp.
- Neralla, S., R.W. Weaver, and B.J. Lesikar. 1998. Plant selection for treatment of septic effluent in subsurface wetlands. In: *Proceedings of the Eighth National Symposium on Individual and Small Community Sewage Systems*. American Society for Agricultural Engineers, Orlando, FL, pp. 247–253.
- Niering, W.A. 1985. *Wetlands*. New York, NY: Alfred A. Knopf, 638 pp.
- Payne, N.F. 1992. *Techniques for wildlife habitat management of wetlands*. New York, NY: McGraw-Hill.
- Post, Buckley, Schuh & Jernigan, Inc. 1993. *Compliance and performance review for the City of Orlando's easterly wetland treatment system*. Prepared for the City of Orlando, FL.
- Reed, S.C., R.W. Crites, and E.J. Middlebrooks. 1995. *Natural systems for waste management and treatment*. 2d ed. New York, NY: McGraw-Hill, 433 pp.
- Reed, S.C., J. Salisbury, L. Fillmore, and R. Bastian. 1996. An evaluation of the "Living Machine" wastewater treatment concept. In: *Proceedings, WEFTEC '96, 69th Annual Conference and Exhibition*, Dallas, TX. Water Environment Federation, Alexandria, VA, October 1996.
- Sather, J.H. 1989. Ancillary benefits of wetlands constructed primarily for wastewater treatment. In: D.A. Hammer (ed.) *Constructed wetlands for wastewater treatment, municipal, industrial, and agricultural*. Chelsea, MI: Lewis Publishers, Chapter 28a, pp. 353–358.
- Schueler, T.R. 1992. *Design of stormwater wetland systems: Guidelines for creating diverse and effective stormwater systems in the mid-Atlantic region*. Anacostia Restoration Team, Metropolitan Washington Council of Governments, Washington, DC. 133 pp.
- Snoddy, E.L., G.A. Brodie, D.A. Hammer, and D.A. Tomljanovich. 1989. Control of the armyworm, *Simyra henrici* (Lepidoptera: Noctuidae), on cattail plantings in acid drainage constructed wetlands at Widows Creek Steam-Electric Plant. In: D.A. Hammer (ed.) *Constructed wetlands for wastewater treatment, municipal, industrial, and agricultural*. Chelsea, MI: Lewis Publishers, Chapter 42I, pp. 808–811.
- Stowell, R., S. Weber, G. Tchobanoglous, B.A. Wilson, and K.R. Townzen. 1985. Mosquito considerations in the design of wetland systems for the treatment of wastewater. In: P.J. Godfrey, E.R. Kaynor, S. Pelczarski, and J. Benforado (eds.) *Ecological considerations in wetlands treatment of municipal wastewaters*. New York, NY: Van Nostrand Reinhold, Chapter 3, pp. 38–47.
- Thunhorst, G.A. 1993. *Wetland planting guide for the northeastern United States: Plants for wetland creation, restoration, and enhancement*. St. Michaels, MD: Environmental Concern, Inc., 179 pp.
- Thut, R.N. 1989. Utilization of artificial marshes for treatment of pulp mill effluents. In: D.A. Hammer (ed.) *Constructed wetlands for wastewater treatment, municipal, industrial, and agricultural*. Chelsea, MI: Lewis Publishers, Chapter 19, pp. 239–244.
- Todd, J. and B. Josephson. 1994. *Living machines: Theoretical foundations and design precepts*. Falmouth, MA: Ocean Arks International.

- U.S. Environmental Protection Agency (EPA). 1988. Design manual: Constructed wetlands and aquatic plant systems for municipal wastewater treatment. Center for Environmental Research Information, Cincinnati, OH.
- U.S. Environmental Protection Agency (EPA). 1993a. Constructed wetlands for wastewater treatment and wildlife habitat. EPA 832-R-005. Office of Water, Washington, DC.
- U.S. Environmental Protection Agency (EPA). 1993b. Sub-surface flow constructed wetlands for wastewater treatment: A technology assessment. EPA 832-R-93-008. Office of Water, Washington, DC.
- U.S. Environmental Protection Agency (EPA). 1997a. Response to Congress on use of decentralized wastewater treatment systems. EPA 832-R-97-001b. Office of Water, Washington, DC.
- U.S. Environmental Protection Agency (EPA). 1997b. Response to Congress on the AEES "Living Machine" Wastewater Treatment Technology. EPA 832-R-97-002. Office of Water, Washington, DC.
- U.S. Environmental Protection Agency (EPA). 1999. Free water surface wetlands for wastewater treatment: A technology assessment. EPA 832/R-99/002. Office of Water, Washington, DC.
- Visher, S.S. 1954. Climatic atlas of the United States. Cambridge, MA: Harvard University Press.
- Vymazal, J. 1995. Algae and element cycling in wetlands. Boca Raton, FL: Lewis Publishers, 689 pp.
- Water Research Commission (South Africa). 2000. Constructed wetlands: The answer to small scale wastewater treatment in South Africa.
- WaterWorld. 1996. Product focus, June.
- Weller, M.W. 1978. Management of freshwater marshes for wildlife. In: R.E. Good, D.F. Whigham, and R.L. Simpson (eds.) Freshwater wetlands: Ecological processes and management potential. New York, NY: Academic Press, pp. 267-284.
- White, K.D. and C.M. Shirk. 1998. Performance and design recommendations for on-site wastewater treatment using constructed wetlands. In: Proceedings of the Eighth National Symposium on Individual and Small Community Sewage Systems. American Society for Agricultural Engineers, Orlando, FL, pp. 195-201.
- Williams, C.R., R.D. Jones, and S.A. Wright. 1996. Mosquito control in a constructed wetland. In: Proceedings, WEFTEC '96, 69th Annual Conference and Exposition, Dallas, TX. Water Environment Federation, Alexandria, VA, October 1996, pp. 333-344.
- Wittgren, H.B. and T. Maehlum. 1996. Wastewater constructed wetlands in cold climates. In: R. Haberl, R. Perfler, J. Laber, and P. Cooper (eds.) Water Science & Technology 35(5), Wetland systems for water pollution control 1996. Oxford, UK: Elsevier Science Ltd., pp. 45-53.
- Wolverton, B.C. 1987. Aquatic plants for wastewater treatment: An overview. In: K.R. Reddy and W.H. Smith (eds.) Aquatic plants for water treatment and resource recovery. Orlando, FL: Magnolia Publishing, pp. 3-15.
- Worrall, P., K.J. Peberdy, and M.C. Millett. 1996. Constructed wetlands and nature conservation. In: R. Haberl, R. Perfler, J. Laber, and P. Cooper (eds.) Water Science & Technology 35(5), Wetland systems for water pollution control 1996. Oxford, UK: Elsevier Science Ltd., pp. 205-213.
- Zirschky, J. and S.C. Reed. 1988. The use of duckweed for wastewater treatment. Journal of the Water Pollution Control Foundation, 60:1253-1258.

Chapter 3

Removal Mechanisms and Modeling Performance of Constructed Wetlands

3.1 Introduction

Constructed wetlands are highly complex systems that separate and transform contaminants by physical, chemical, and biological mechanisms that may occur simultaneously or sequentially as the wastewater flows through the system. In a qualitative sense, the processes that occur are known, but in only a few cases have they been adequately measured to provide a more quantitative assessment. The predominant mechanisms and their sequence of reaction are dependent on the external input parameters to the system, the internal interactions, and the characteristics of the wetland. The external input parameters most often of concern include the wastewater quality and quantity and the system hydrological cycle.

Typical characteristics of municipal wastewaters most often treated in constructed wetlands are described in Table 3-1. The emphasis of this manual is on the treatment of municipal wastewater with the objectives of achieving target levels of suspended solids, organic matter, pathogens, and in some instances, nutrients (specifically total nitrogen) and heavy metals. Wastewaters that will be considered include septic tank effluent, primary effluent, pond effluents, and some secondary effluents from overloaded or poorly controlled systems. Table 3-1 shows that the character of the wastewater is dependent on pretreatment and

may contain both soluble and particulate fractions of organic and inorganic constituents in reduced or oxidized forms. As will be seen later, these characteristics play an important role in the major mechanisms of removal.

The two major mechanisms at work in most treatment systems are liquid/solid separations and constituent transformations. Separations typically include gravity separation, filtration, absorption, adsorption, ion exchange, stripping, and leaching. Transformations may be chemical, including oxidation/reduction reactions, flocculation, acid/base reactions, precipitation, or a host of biochemical reactions occurring under aerobic, anoxic, or anaerobic conditions. Both separations and transformations may lead to contaminant removal in wetlands but often only result in the detention of the contaminant in the wetland for a period of time. There may be changes in the contaminant composition that will effectively achieve treatment objectives, such as the biochemical transformation of organic compounds to gases such as CO₂ or CH₄. A biochemical transformation, however, may produce biomass or organic acids that may not achieve the treatment objective if these materials escape in the effluent. In the case of biomass, it may escape as volatile suspended solids, or it may undergo further bacterial reaction, which may result in the leaching of a soluble carbon compound back into the water column.

The remainder of this chapter will review potential mechanisms that may be at work in constructed wetlands. These reactions may occur in the water column, on the surfaces of plants, within the litter and detritus accumulating at the wetland surface or on the bottom, or within the root zone of the system. The reactions unique to the wetland type will also be delineated.

3.2 Mechanisms of Suspended Solids Separations and Transformations

3.2.1 Description and Measurement

Suspended solids in waters are defined by the method of analysis. Standard Methods (1998) defines total suspended solids as those solids retained on a standard glass fiber filter that typically has a nominal pore size of 1.2µm. The type of filter holder, the pore size, porosity, area and thickness of the filter, and the amount of material depos-

Table 3-1. Typical Constructed Wetland Influent

Constituent (mg/L)	Septic Tank Effluent ¹	Primary Effluent ²	Pond Effluent ³
BOD	129-147	40-200	11-35
Sol. BOD	100-118	35-160	7-17
COD	310-344	90-400	60-100
TSS	44-54	55-230	20-80
VSS	32-39	45-180	25-65
TN	41-49	20-85	8-22
NH ₃	28-34	15-40	0.6-16
NO ₃	0-0.9	0	0.1-0.8
TP	12-14	4-15	3-4
OrthoP	10-12	3-10	2-3
Fecal coli (log/100ml)	5.4-6.0	5.0-7.0	0.8-5.6

¹EPA (1978), 95% confidence interval. Prior to major detergent reformulations which reduce P species by ~50%.

²Adapted from Metcalf and Eddy, (1991) assuming typical removal by primary sedimentation-soluble BOD = 35 to 45% total.

³EPA (1980).

ited on the filter are the principal factors affecting the separation of suspended from dissolved solids. As a result, the measurement reported for total suspended solids may include particle sizes ranging from greater than 100µm to about 1µm. Soluble (dissolved) solids would therefore include colloidal solids smaller than 1µm and molecules in true solution. A classical method of solids classification by size would include the following:

Settleable Solids	>100µm
Supracolloidal Solids	1–100µm
Colloidal Solids	10–3–1µm
Soluble Solids	<10–3µm

Solids are also classified as volatile or fixed, again based on the method of analysis. Standard Methods (1998) defines a volatile solid as one that ignites at 550°C. Although the method is intended to distinguish between organic solids and inorganic solids, it is not precise since volatile solids will include losses due to the decomposition or volatilization

of some mineral salts depending on the time of exposure to the ignition temperature.

Wastewater influents to wetlands may contain significant quantities of suspended solids (Table 3-1). The composition of these solids is quite different, however. Septic tank and primary effluents will normally contain neutral density colloidal and supracolloidal solids emanating from food wastes, fecal materials, and paper products. Pond effluent suspended solids are likely to be predominantly algal cells. All three will be high in organic content. Size distribution is also different among the waste streams. Tables 3-2 and 3-3 present information on size distributions of suspended solids, organic matter, and phosphorus in domestic wastewaters with various levels of pretreatment. It should be noted that methods differed between investigators on estimating size ranges. High settleable fractions are not surprising for raw wastewater samples or for the pond effluent containing algal cells. It is important to note the association of organic matter and phosphorus with the various solid fractions.

Table 3-2. Size Distributions for Solids in Municipal Wastewater

Size Range (µm)	Type of Sample (% by Weight)				
	Primary Eff. ¹	Primary Eff. ²	Primary Eff. ³	Raw Sewage ⁴	Raw Sewage ⁵
<10 ⁻³	-	-	-	31	48
10 ⁻³ -1.0	20	22(10-30)	-	14	9
1.0-12	54	35(24-51)	-	-	-
>12	26	43(30-60)	-	-	-
1.0-100	-	-	81	24	18
>100	-	-	19	31	23

¹ Levine et al. (1984).

² Tchobanoglous et al. (1983).

³ Gearheart, et al. (1993).

⁴ Heukelekian and Balmat (1959).

⁵ Rickert and Hunter ((1972).

Table 3-3. Size Distribution for Organic and Phosphorus Solids in Municipal Wastewater

Size Range (µm)	Type of Solids (% by Weight)							
	Organic Solids ¹ (primary effluent)	Organic Solids ² (primary effluent)	Organic Solids ² (primary effluent)	Organic Solids ² (primary effluent)	Organic Solids ² (primary effluent)	Organic Solids ³ (raw sewage)	Total Phos. ⁴ (primary effluent)	Total Phos. ⁴ (primary effluent)
<10 ⁻³	9	-	-	-	-	42	-	-
<0.1	-	51	50	25	35	-	17.2	15.7
10 ⁻³ -1.0	?	-	-	-	-	11	-	-
0.1-1.0	-	8	19	2	1	-	54.6	67.0
1.0-12	-	34	26	13	13	-	7.1 ⁵	6.7 [*]
>12	-	7	5	60	41	-	21.0 ⁶	8.5 ^{**}
1.0-100	15	-	-	-	-	20	-	-
>100	28	-	-	-	-	27	-	-

¹ Munch et al. (1980).

² Levine et al. (1991).

³ Rickert and Hunter (1972).

⁴ Levine et al. (1984).

⁵ Range: 1-5 µm

⁶ Range: >5 µm

3.2.2 Suspended Solids in Free Water Surface Wetlands

Total suspended solids are both removed and produced by natural wetland processes. The predominant physical mechanisms for suspended solids removal are flocculation/sedimentation and filtration/interception, whereas suspended solids production within the wetland may occur due to death of invertebrates, fragmentation of detritus from plants, production of plankton and microbes within the water column or attached to plant surfaces, and formation of chemical precipitates such as iron sulfide. Figure 3-1 illustrates the most important of these processes as they occur in a FWS system. Resuspension of solids may occur due primarily to turbulence created by animals, high inflows, or winds. A brief discussion of some of these processes and how they may affect free water surface systems follows.

3.2.2.1 Discrete and Flocculant Settling

Typically, particulate settling produced by gravity may be categorized as discrete or flocculant settling. Both separation processes exploit the properties of particle size, specific gravity, shape, and fluid specific gravity and viscosity. Discrete settling implies that the particle settles indepen-

dently and is not influenced by other particles or changes in particle size or density. A mathematical expression for the terminal settling velocity of the discrete particle may be derived from Newton's Law. Under laminar flow conditions, which exist in fully vegetated zones of a FWS and in VSBs, the velocity of a spherical particle can be estimated by Stokes' Law, which states that the settling velocity is directly proportional to the square of the nominal diameter and the difference in particle and fluid densities and is inversely proportional to fluid viscosity. Drag on the particle that influences settling velocity is affected by particle shape, fluid/particle turbulence, and fluid viscosity.

Whereas discrete settling can be estimated given the independent variables discussed previously, flocculant settling cannot be so easily determined, requiring experimental measurement. It occurs as the result of particle growth and, perhaps, change in characteristics over time. As a result, particle settling velocity typically increases with time. Flocculant settling is promoted by the relative movement of target particles in such a fashion as to cause an effective collision. This relative velocity (velocity gradient) is often calculated as G , the mean velocity gradient, which is a function of power input, dynamic viscosity, and system volume (Camp and Stein, 1943). Effective velocity gradi-

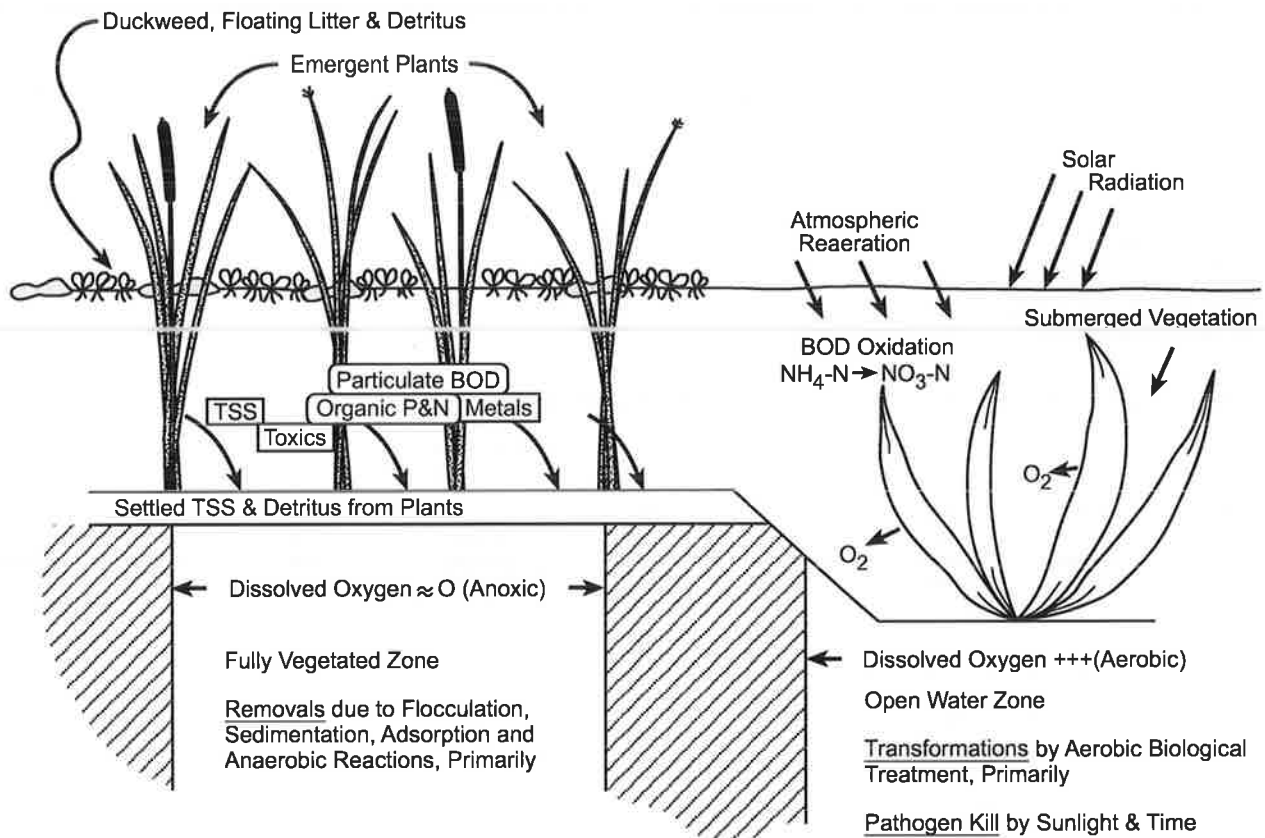


Figure 3-1. Mechanisms that dominate FWS systems

ents for flocculation range from 10 to 75 sec⁻¹. Flocculation may occur naturally, as when fresh water flows into saline water forming a delta, or it may require chemical (coagulant) addition. It may affect large particles (100µm to 1000µm) of low to moderate specific gravity (1.001 to 1.01) and small particles (1.0µm to 10µm) with high specific gravity (1.5 to 2.5). The formation of larger flocculant particles is dependent on the electric charge on the particle surface. Like electrical charges on the double layer surrounding particles may produce particle stability that hinders attachment even if collisions take place. This charge is sensitive to the composition of the fluid. Adsorption of solutes to the surface occurs as a result of a variety of binding mechanisms, which may eventually result in the destabilization of the particles and result in particle adhesion. There has been little work done on the evaluation of natural flocculation phenomena with primary effluent or algal cells. The existence of emergent plant stems in FWS wetlands will promote effective velocity gradients for particle collisions, but the adhesion of these particles would be dependent on surface properties that would be influenced by water column quality.

In wetland systems treating primary or septic tank effluents (or secondary effluents), particle sizes are mostly in the colloidal to low supracolloidal range (Table 3-2). Typically sedimentation processes will remove material larger than about 50µm with specific gravity of about 1.20. The remaining particles are normally the lower density materials. Using Stokes' Law to approximate discrete settling velocity, particles ranging from 1.0µm to 10µm with a specific gravity ranging from 1.01 to 1.10 will settle at a rate of from 0.3 to 4 x 10⁻⁴m/d. Typical hydraulic loads to FWS wetlands are in the range of 0.01 to 0.5 m/d (note that the hydraulic load is equivalent to the mean settling velocity of a particle that will be removed exactly at that loading). Assuming the higher settling velocity of 0.3 m/d and a typical FWS system velocity of 50 m/d and depth of 0.8m, the larger particles would settle by gravity in approximately 2.7 days, or 133 m along the wetland longitudinal axis. The smaller, less dense particles would require over 200 days and a length of over 11,000 m. Therefore it can be concluded that the larger, denser particles could be removed in the primary zone of a wetland based on simple discrete settling theory (see Chapter 4 for more details on design). The smaller, neutral-density particles, which make up a significant fraction of septic tank and primary effluent, are not likely removed in this primary zone by simple discrete sedimentation, but may be flocculated due to the velocity gradients imposed by emergent plant stems in the water column. It is also possible that some particles may be intercepted by angular emergent plant tissue as would occur in settling basins equipped with plate or tube settlers. Clearly, removal of TSS by a FWS wetland is more complex than predicted by discrete settling theory. There is currently insufficient transect data available on wastewater influents of interest to develop a rational separation model, either qualitatively or quantitatively, for TSS removal from primary or septic tank effluents in FWS systems.

For wetland systems receiving pond effluents, the primary source of suspended solids for much of the season is algal cells. These cells include green algae, pigmented flagellates, blue-greens, and diatoms. Sizes range from 1µ to 100µm, and shapes may range from coccoid to filamentous. Specific gravity of actively growing algal cells may be close to that of water insofar as they must remain suspended high up within the water column in order to survive. Flotation may be accomplished by gas vacuoles (blue-green algae), gelatinous sheathes, or shapes that increase particle drag. It is believed that wind-induced turbulence and vertical water motion greatly influence algae distribution in ponds (Bella, 1970). Motile algae are not typically predominant in wastewater pond systems. Once algal cells die for lack of nutrients and/or sunlight, they lose this flotation characteristic and will settle. Settling velocities range from 0.0 to 1.0 m/s (typically, 0.1 to 0.3 m/s) depending on species and physiological condition (Hutchinson, 1967). It is likely that many of these cells will be removed by sedimentation in wetlands covered by emergent vegetation providing shading and reducing wind action. Flocculation of the cells within the wetland is also possible although little experimental evidence has been presented to date. Table 3-4 was generated by Gearheart and Finney (1996), and it represents the only known application of the particle-size theory to show that colloidal fractions are flocculated in FWS systems (see Chapter 4 for further explanation). Figure 3-2 illustrates the removal of TSS observed for a fully vegetated FWS wetland treating pond effluent. Attempts to settle algae from ponds in open settling basins have not been successful, however, likely due to the presence of light and wind action.

3.2.2.2 Filtration/Interception

Filtration, in the usual sense of this unit process, is not likely to be significant in surface wetlands. Stems from emergent plants are too far apart to effect significant entrapment of the particle sizes found in influent to these wetlands. Furthermore, plant litter and detritus at the surface and bottom of the wetland are high in void fraction such that filtration is not likely an important mechanism. On the other hand, interception and adhesion of particles on plant surfaces could be significant mechanisms for removal. The efficiency of particle collection would be dependent on particle size, velocity, and characteristics of the particle and the plant surfaces that are impacted. In wetlands, plant surfaces in the water column are coated with an active biofilm of periphyton. This biofilm can adsorb colloidal and supracolloidal particles as well as absorb soluble molecules. Depending on the nature of the suspended solids, they may be metabolized and converted to soluble compounds, gases, and biomass or may physically adhere to the biofilm surfaces to eventually be sloughed off into the surrounding water column. Similar reactions may occur in the surface detritus or at the surficial bottom sediment. To date, there have been no definitive studies reported on the importance of this mechanism in suspended solids removal in free surface wetlands.

3.2.2.3 Resuspension

In FWS wetlands, velocity induced resuspension is minimal. Water velocities are too low to resuspend settled par-

Table 3-4. Fractional Distribution of Bod, COD, Turbidity, and SS in the Oxidation Pond Effluent and Effluent from Marsh Cell 5 (Gearheart and Finney, 1996)

	BOD		COD		Turbidity		SS	
	mg/l	%	mg/l	%	NTU	%	MG/L	%
Oxidation Pond Fraction								
Total	27.5	100	80	100	11.0	100	31.0	100
Settleable	3.7	13	5	6	2.5	23	5.8	19
Supracolloidal	13.7	50	23	29	5.3	48	25.2	81
Colloidal, soluble	10.1	37	52	65	3.2	29	-	-
Marsh Fraction								
Total	4.8	100	50	100	3.9	100	2.3	100
Settleable	0	0	0	0	0.6	15	0.3	13
Supracolloidal	1.2	24	4	8	1.6	42	2.0	87
Colloidal, soluble	3.6	76	46	92	1.7	43	-	-

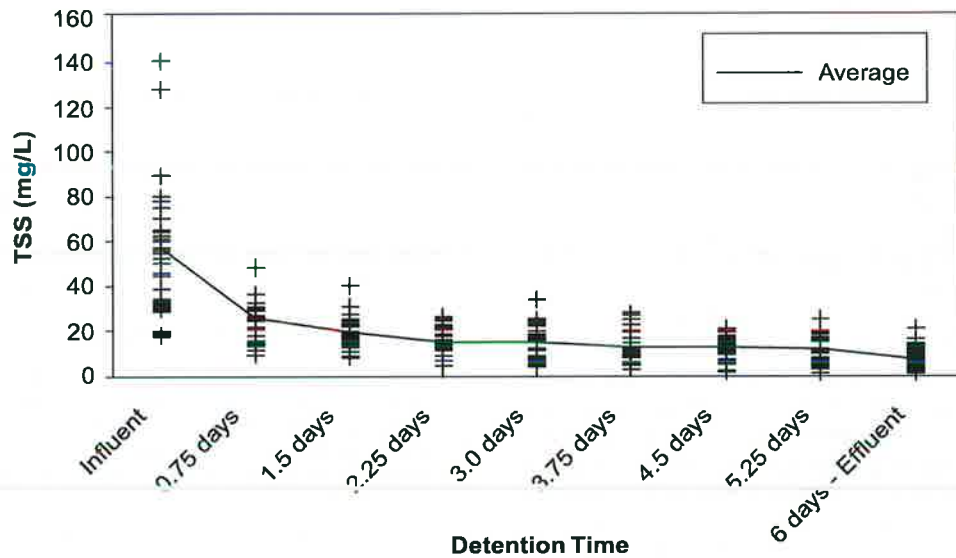


Figure 3-2. Weekly transect TSS concentration for Arcata cell 8 pilot receiving oxidation pond effluent (EPA, 1999)

ticles from bottom sediments or from plant surfaces. Furthermore, fully vegetated wetlands provide excellent stabilization of sediments by virtue of sediment detritus and root mats. The reintroduction of settled solids in wetlands is most likely due to gas-lift in vegetated areas or bioturbation or wind-induced turbulence in open water areas. Wetland sediments and microdetritus are typically near neutral buoyancy, flocculant, and easily disturbed. Bioturbation by fish, mammals, and birds can resuspend these materials and lead to increases in wetland suspended solids. The oxygen generated by algae and submerged plants, nitrogen oxides and nitrogen gas from denitrification, or methane formed in anaerobic process may cause flotation of particulates (Kadlec and Knight, 1996).

As discussed previously, the generation of new biomass by primary production or through the metabolism of influent wastewater constituents will eventually result in the return of some suspended materials back into the water column. The magnitude of wetland particulate cycling is large, with high internal levels of gross sedimentation and resuspension, and almost always overshadows influent TSS loading in natural or tertiary treatment wetlands. The effluent TSS from a wetland rarely results directly from nonremovable TSS in the influent wastewater and is often dictated by the wetland processes that generate TSS in the wetland. Typical background TSS concentrations expected in FWS wetlands appear in Table 3-5. It should be noted that large expanses of open wetland prior to dis-

charge structures could result in unusually high effluent TSS concentrations due to the production of excessive amounts of algae and induced high levels of wildlife activities that could produce effluent variations as typified in Figure 3-3.

High incoming TSS or organic loading will result in a measurable increase in bottom sediments near the inlet structure (Van Oostrom and Cooper, 1990; EPA, 1999). However, no FWS treatment wetland has yet required maintenance because of sediment accumulation, including some that have been in service for over 20 years.

3.2.3 Suspended Solids in Vegetated Submerged Beds

One of the primary intermediate mechanisms in the removal of suspended solids by VSB systems is the flocculation and settling of colloidal and supracolloidal particulates. These systems are relatively effective in TSS removal because of the relatively low velocity and high surface area in the VSB media. VSBs act like horizontal gravel filters and thereby provide opportunities for TSS separations by gravity sedimentation (discrete and flocculant), straining and physical capture, and adsorption on biomass film attached to gravel and root systems. Clogging of the filter media has been of some concern especially with high TSS loading, but documentation of this phenomenon has not been forthcoming. The accumulation of recalcitrant or slowly degradable solids may eventually lead to increased headlosses near the influent end of the system. Design features to overcome this are described in Chapter 5.

The importance of vegetation in VSB systems has been debated for some time. Several recent studies have com-

pared pollutant removal performance of planted and unplanted VSB systems and have shown no significant difference in performance (Liehr, 2000; Young et al., 2000). The importance of plant type has also been evaluated (Gersberg et al., 1986; Young et al., 2000). Maximum root length and growth rates have been reported. Although some investigators claimed that certain treatment goals are likely to benefit from certain plants, these claims have not been sustained by others (Young et al., 2000). The extension of root system within the gravel bed is dependent on system loading, plant type, climate, and wastewater characteristics, among other variables. It appears that a dominant fraction of the flow passes below the root system in VSB facilities. The role of root surfaces in TSS removal has not been proven experimentally.

The contributions of internal biological processes to effluent TSS is likely similar to that found in FWS systems, although algal contributions should be negligible. Resuspension of separated solids is not likely since system velocities are low and scouring should not be significant. Furthermore, bioturbation in these systems should be minimal. Background concentrations for VSB systems have not yet been definitively documented with reliable information.

3.3 Mechanisms for Organic Matter Separations and Transformations

3.3.1 Description and Measurement

Organic matter in wastewater has been measured in a number of ways over the years. Because the organic fraction in wastewater is often complex and the concentrations of the individual components relatively low, analyses

Table 3-5. Background Concentrations of Contaminants of Concern in FWS Wetland Treatment System Effluents

Constituent	Range (mg/L)	Typical (mg/L)	Factors Governing Value	Reference
TSS	2-5	3	Plant types, coverage, Climate, wildlife	Reed et al., 1995; Kadlec and Knight, 1996
BOD ₅ ¹	2-8	5	Plant types, coverage, Climate, plant density	Reed et al., 1995 Gearheart, 1992
BOD ₅ ²	5-12	10	Plant types, coverage, Climate, plant density	Kadlec and Knight, 1996
TN	1-3	2	Plant types, coverage, Climate, oxic/anoxic	Kadlec and Knight, 1996; Reed et al., 1995
NH ₄ ⁺ N	0.2-1.5	1.0	Plant types, coverage, Climate, oxic/anoxic	Kadlec and Knight, 1996; Reed et al., 1995
TP	0.1-0.5	0.3	Plant types, coverage, Climate, soil type	Kadlec and Knight, 1996; Reed et al., 1995
Fecal Coli CFU/100 ml	50-5,000	200	Plant types, coverage, Climate, wildlife	Watson et al, 1987; Gearheart et al., 1989

¹Wetland system with significant open water and submergent vegetation

²Wetland system fully covered by emergent vegetation

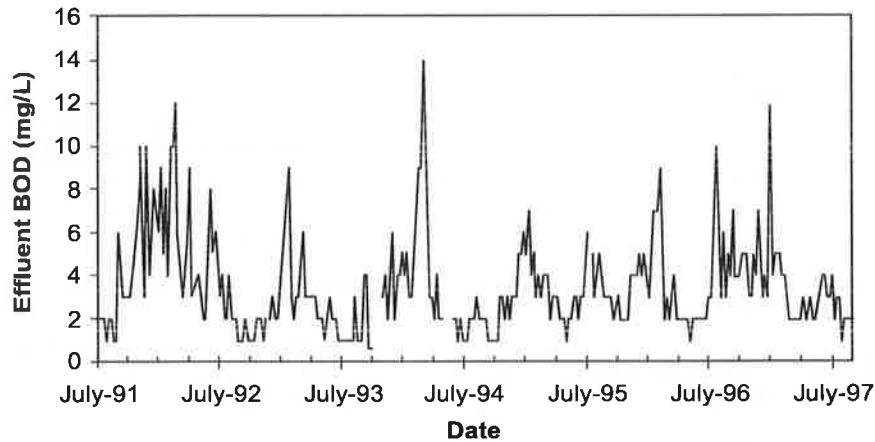


Figure 3-3. Variation in effluent BOD at the Arcata enhancement marsh (EPA, 1999)

are often performed on the aggregate amount of organic matter comprising organic constituents with common characteristics. Methods for total organic carbon (TOC) and volatile solids (VS) measure the total amount of organic matter present. Chemically oxidizable organic matter is often measured as Chemical Oxygen Demand (COD), expressed in units of oxygen, and biodegradable organic matter is determined by the Biochemical Oxygen Demand (BOD) procedure. All of these aggregate methods have a place in assessing pollutant levels in water, but none will provide information on specific organic molecules or their fate in treatment processes. As a result, any qualitative or quantitative model attempting to express mechanistic behavior of organic matter in a system is an empirical model based on observation of the parameter of interest. In wetlands, physical, chemical, and biochemical reactions will transform and/or separate organic matter, often leading to different species of organic molecules. Thus the BOD (or COD, or TOC) of the influent to a wetland does not measure the same organic constituents that appear in the effluent. This phenomenon is no different than what has already been discussed for TSS.

Most regulatory agencies today establish wastewater discharge permit limits based on BOD values; thus much of the data available is expressed as that parameter. It is difficult to use BOD in mass balance calculations insofar as it is a dynamic measure conducted over a finite time (usually five days) and at a specified temperature (usually 20°C). One can use it to estimate roughly the oxygen requirements for aerobic systems if the rate of oxygen demand exertion (expressed by the biodegradation constant, k) is known. To further complicate the use of this parameter, the analysis of BOD may or may not include the nitrogenous oxygen demand (NOD), which may be expressed concurrently or simultaneously with the carbonaceous oxygen demand. Thus primary influent BOD_5 may measure carbonaceous organic matter, whereas effluent from the wetland may include both carbonaceous and ni-

trogenous (ammonia) matter depending on the system. Table 3-1 presents typical values of total and soluble BOD for primary and septic tank effluents as well as lagoon effluents. Values of COD and VSS (volatile suspended solids) are also provided. There is no simple way to relate BOD and COD values for wastewater insofar as the differences that exist between degradable and chemically oxidizable fractions.

3.3.2 Organic Matter in Free Water Surface Wetlands

3.3.2.1 Physical Separations of Organic Matter

Table 3-4 illustrates that influents typically received by FWS systems contain some particulate organic matter. A significant amount of the influent from septic and primary effluents is in the dissolved and colloidal fraction as would be expected, whereas pond effluents may contain a sizeable fraction of supracolloidal material represented by algal cells. Separation of particulate organic matter would occur by the same mechanisms as those described for TSS. It is not uncommon to find organic matter removal in the influent end of a FWS system that parallels TSS removal. Figure 3-4 illustrates predominant organic matter separations and transformations that occur in FWS systems. As noted in section 3.3.2.2, biochemical transformations of the entrapped and settled organic matter will greatly influence the apparent removal of total organic matter within the water column.

Soluble organic matter may also be removed by a number of separation processes. Adsorption/absorption (the movement of contaminants from one phase to another) is an important process affecting some organic molecules. The process is often referred to as sorption to cover both adsorption and absorption processes in natural systems because the exact manner in which partitioning to the solids occurs is often not known. Partitioning of organic matter between solids can be understood and predicted to

some degree using physiochemical properties of the organic (e.g., water solubility, octanol-water partition coefficient). Sorption is often described by an isotherm (Freundlich) relationship. The degree of sorption and its rate are dependent on the characteristics of both the organic and the solid. In wetlands, the important solid surfaces would include the plant litter and detritus occurring at the wetland surface or on the bottom and plant stems and leaves often covered by a periphyton biofilm. The sorption process may be reversible or irreversible depending on the organic and solid. Sorbents may eventually become "saturated" with sorbate although often the sorbed organic is biochemically transformed, renewing the sorbent capacity. Many of the wetland solid surfaces are also renewed by continuous turnover of biomass that makes up the major component of the sorbent. It is believed that sorption processes play an important role in organic separation in wetlands, but the processes have not been adequately quantified at this time.

Volatilization may also account for loss of certain organics. In this reaction, the organic partitions to the air. The propensity for a given compound to move from liquid to gaseous phase is measured by Henry's constant. The higher the value for a compound, the more likely it will partition to the gaseous phase. Generally, organic matter entering a wetland receiving pretreatment will not contain sig-

nificant quantities of volatile compounds (VOCs). Facultative lagoons have been shown to remove 80 to 96% of volatile organics from municipal wastewater (Hannah et al., 1986). However, some of these organic materials may be produced by biological transformations. Precipitation reactions with organic matter found in wetland influents have not been documented for municipal wastewater.

3.3.2.2 Biological Conversions of Organic Matter

The Biochemistry

Biochemical conversions are important mechanisms accounting for changes in concentration and composition of biodegradable organic matter in wetlands. They may account for removal of some organic constituents by virtue of mineralization or gasification and the production of organic matter through synthesis of new biomass. Organisms will consume organic matter (and inorganic matter as well) in order to sustain life and to reproduce. The organic matter in wastewater serves as an energy source as well as a source of molecular building blocks for biomass synthesis. The reactions occurring therefore are ones that prepare the molecule for use by the organism or are directly involved in the extraction of energy or incorporation of building blocks in the synthesis reaction. End products of the reaction are waste products of the system. These

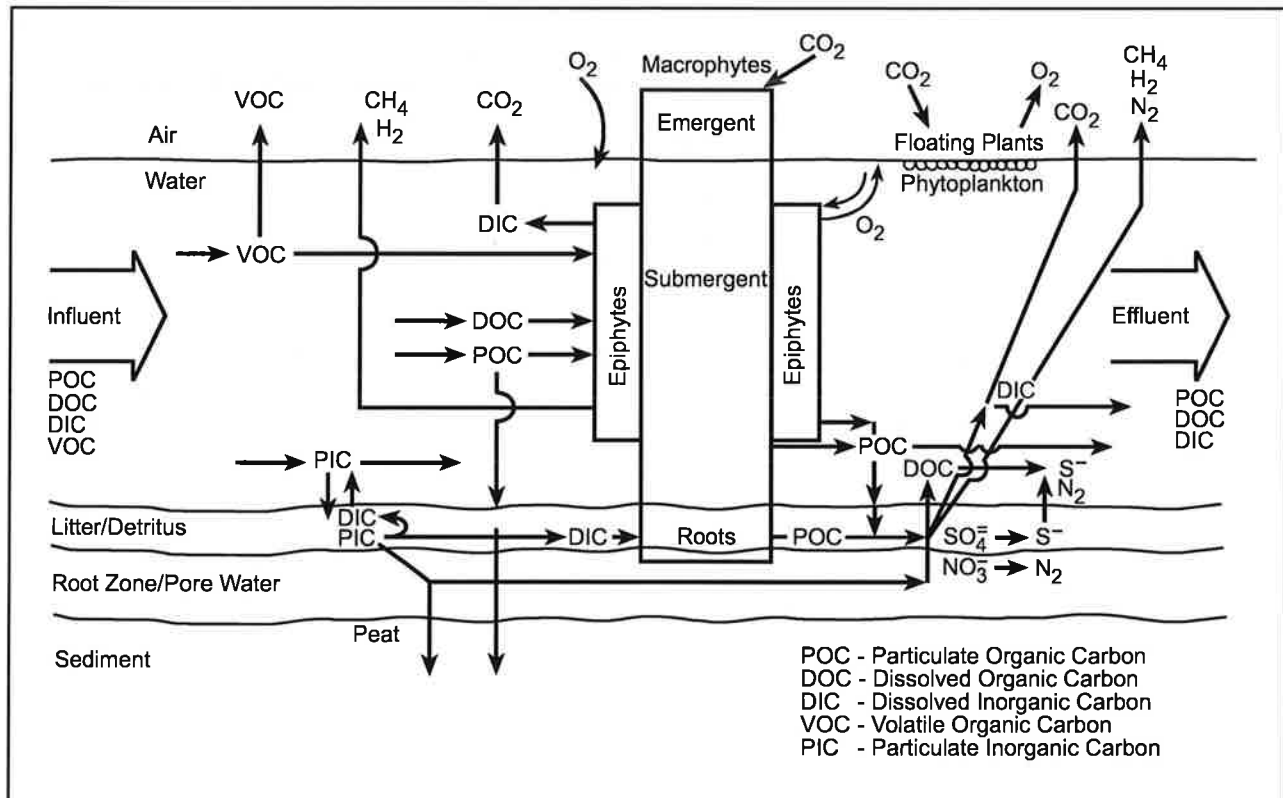


Figure 3-4. Carbon transformations in a FWS wetland

reactions include oxidation/reduction processes, hydrolysis, and photolysis.

Since energy is a key element in the biochemical system, the reaction is classified as chemotrophic or phototrophic depending on whether the reaction utilizes a chemical source of energy or light energy. The environment greatly influences the energetics of the reaction that is driven by electron transfers. If the element at the end of this set of transfers is oxygen, the reaction is referred to as an aerobic reaction. Aerobic metabolism requires dissolved oxygen and results in the most efficient conversion of biodegradable materials to mineralized end products, gases, and biomass. Anoxic (anaerobic respiration) reactions use nitrates, carbonates, or sulfates as terminal electron acceptors (in place of oxygen). Terminal electron acceptors are subsequently reduced in these reactions, producing end products such as nitrogen oxides, free nitrogen, sulfur, thiosulfate, and so forth. These reactions are typically less efficient (biomass produced per unit substrate utilized) than aerobic reactions and produce mineralized end products and gases, but less biomass per unit of substrate converted. Anaerobic metabolism takes place in the absence of dissolved oxygen and uses organic matter as the terminal electron acceptor as well as the electron donor. These transformations are the least efficient of the biochemical reactions and will not result in the reduction in BOD (or COD) unless hydrogen or methane is produced, since electrons released in the oxidation of the organic are passed to electron acceptors (reduced products such as alcohols and organic acids) that remain in the medium. The only energy loss in the system is that due to microbial inefficiencies.

The transformations described previously rely on chemical energy to drive them. A very important transformation that takes place in open water areas of FWS wetlands uses sunlight energy to drive the reaction (photosynthesis). In these reactions, inorganic carbon (CO_2 and carbonates) is synthesized to form biomass (primary production), releasing oxygen. Thus both oxygen and organic matter are produced within the system.

The previous reactions and their stoichiometry, equilibrium, and rates are dependent on environmental variables including dissolved oxygen, temperature, oxidation/reduction potential, and chemical characteristics, to name a few. An excellent reference on microbial metabolism in wastewater systems can be found in Grady and Lim (1980).

The Organisms

Biochemical reactions of importance in FWS constructed wetlands are carried out by a large number of organism classes. They may be classified based on their position in the energy or food chain (producers, consumers, or decomposers) or on their life form or habitat. A classical description relative to a wetland habitat would include

- Benthos—organisms attached or resting on the bottom within the plant litter and detritus or living within the sediments

- Periphyton—both plants and animals attached to stems and leaves of rooted plants
- Plankton—floating plants or animals whose movements are generally dictated by currents
- Neuston—plants or animals resting or swimming on the wetland surface
- Nekton—swimming organisms able to navigate at will

Although no quantitative assessments have been reported, it is believed that the decomposers (bacteria, actinomycetes, and fungi) play the most important role in wetlands relative to the removal of organic matter by way of mineralization and gasification. They are associated with all habitats listed. They are also responsible for the synthesis of biomass and the production of organic metabolic end products that may leach into the water column. These organisms are often classified as aerobic, facultative, or anaerobic, depending on the type of reactions that they perform. They may also be classified with respect to their source of energy and the type of chemical compound that they use as a source of carbon.

The primary producers generate organic residues within the wetland and add dissolved oxygen to the system. They also play an important role in the removal and recycling of nutrients in the wetland. The macrophytes will also prevent incoming radiation from entering the water column. This shading will affect the growth of plant periphyton, phytoplankton, and submerged macrophytes, will interfere with surface mass transfer of oxygen, and will moderate wetland water temperatures. These rooted plants provide significant submerged surfaces for growth of periphyton. The submerged surface area provided by selected FWS vegetation varies from 2.2 to 6.5 m^2/m^2 for a wetland 0.5 m deep, depending on plant species and coverage (EPA, 1999).

Oxygen Transfer to FWS Wetlands

Oxygen is a critical element in the biochemical transformation of organic matter (as well as other compounds to be described later). As briefly discussed previously, biochemical reactions that use dissolved oxygen (DO) are efficient processes and yield mineralized end products. An aerobic environment is highly desirable in wastewater treatment systems in which the target is effective removal of BOD. There are three possible sources of DO in wetland systems—surface aeration, photosynthesis, and plant oxygen transfer.

When a gas is dissolved in water, the process is generally treated as a mass transfer occurring over four steps (two-film theory). It presumes a thin but finite gaseous and liquid film at the air-water interface. The gas must pass through the bulk gas phase, then through the gas film, to the liquid film, and then into the bulk liquid. For oxygen, the liquid film is the rate-limiting step and controls the rate of mass transfer, although for a quiescent water body, the bulk liquid transport may control the process. By use of Fick's Law, the diffusional process can be modeled pro-

ducing the commonly used oxygen mass transfer relationship:

$$dC/dt = K_L a (C_s - C_o) \quad (3-1)$$

Where C = concentration of oxygen in water (M/L^3)
 t = time (T)
 $K_L a$ = overall mass transfer coefficient for oxygen in water ($1/T$)
 C_s = steady-state oxygen saturation concentration in water (M/L^3)
 C_o = the dissolved oxygen concentration in the bulk water (M/L^3)

This equation indicates that the rate of oxygenation is dependent on the overall mass transfer coefficient, the steady-state DO saturation concentration for oxygen in water, and the bulk water DO. Generic symbols for mass (M), time (T), and length (L) are employed for units. The value of $K_L a$ is a function of the physical characteristics of the wetland. For typical FWS systems, isotropic turbulence would occur whereby there is neither a significant velocity gradient nor shearing stress. For this system, the value of $K_L a$ would be a direct function of wetland velocity and the oxygen molecular diffusion coefficient and an indirect function of system depth (O'Connor and Dobbins, 1958) according to the following equation:

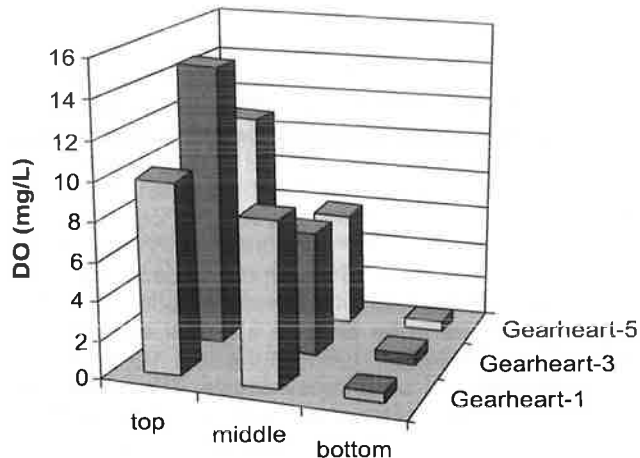
$$K_2 = [D_L U]^{1/2} / H^{3/2} \quad (3-2)$$

Where K_2 = surface reaeration coefficient ($1/T$)
 D_L = oxygen molecular diffusion coefficient (L^2/T)
 U = velocity of flow (L/T)
 H = depth (L)

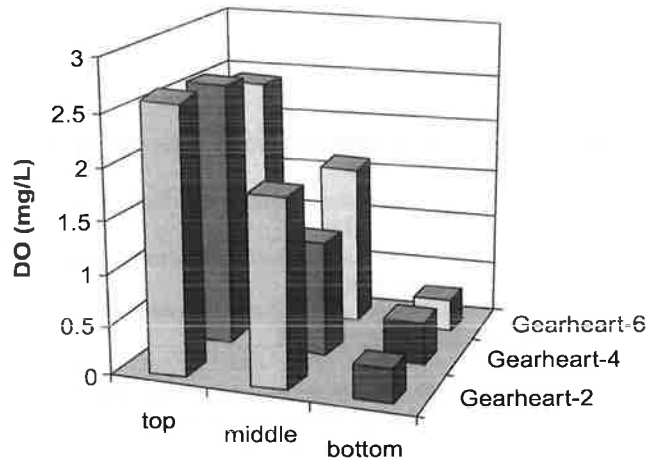
An estimate of surface aeration in an open water zone of a FWS system can be made assuming a typical wetland water velocity of 30 m/d and a depth of 0.3 m. At 20°C, the mass transfer coefficient would be approximately 0.43/d. Assuming a bulk wetland water DO of 0 mg/L, the mass transfer of oxygen would be about 3.9 mg/L/d or 1.2 g/m²/d. For more realistic values of the water DO, the transfer would range from 0.5 to 0.9 g/m²/d. These numbers compare favorably with values reported by the TVA, which range from 0.50 to 1.0 g/m²/d (Watson et al., 1987). These open water-zone values will be higher than would be observed in wetlands with plant cover because plant debris, floating plants, and emergent plant surfaces impede mass transfer across the surface. In the open zones, the bulk water DO (which might approach 0 mg/L) would not be the same as the DO near the water surface (which might approach saturation during the daylight hours). See Figure 3-5 for a submergent plant (open water) zone, which illustrates the inaccuracy that would result in assuming a DO of 0 mg/L in the bulk water column. The actual DO values in Figure 3-5 are from polishing FWS applications and are therefore higher than would be expected in a treatment FWS system. Actually, a value near zero DO is normal in fully vegetated or emergent zones (Figure 3-5b) of these latter systems.

Oxygen will also be transferred to the wetland by virtue of photosynthesis carried out by phytoplankton, periphyton, and submerged plants. The general relationship for photosynthesis of green plants implies that approximately 2.5 g of oxygen would be evolved per g of carbon fixed as cell mass. In the absence of sunlight energy, oxygen would be consumed by these plants in respiration. Presuming highly productive conditions, about 1.0 g C/m²/d may be produced during daylight hours resulting in a generation of 2.5 g O₂/m²/d (Lewin, 1962). One may deduce a somewhat larger value presuming typical net primary production of a wetland to be about 4.0 g total biomass/m²/d (Mitsch and Gosselink, 1993) and about 1.0 g O₂/g net biomass produced by photosynthesis. These numbers imply that in open areas where sufficient photosynthesis might occur, oxygen should be available for aerobic oxidation within the water column, at least during part of the day. Active plant respiration during the evening may completely negate the oxygenation estimated during daylight hours, however. The DO concentrations have been documented for both emergent and submergent plant zones in the Arcata tertiary/polishing/enhancement marsh system (Figure 3-5). Clearly, the submergent plant zone provided more DO by virtue of greater photosynthesis and surface aeration. This figure also clearly demonstrates that the bulk water column is not mixed with respect to DO, being highest at the surface where atmospheric reaeration and photosynthesis are predominant. Rose and Crumpton (1996) have demonstrated the effects of emergent macrophyte stands and open water in a prairie wetland. They found that the emergent sites had low DO concentrations and were almost always anoxic, whereas sites at the edge of the stand had higher DO concentrations, with significant increases in DO during the daylight hours. The open water areas consistently exhibited higher values of DO with diurnal changes up to 10 mg/L. These results are consistent with the presumption that emergent stands provided a heavy canopy cover, along with small floating plants and plant litter that obscured light penetration and subsequent photosynthesis and also affected surface aeration. The plant litter stands at the margin were open and allowed light penetration, encouraging photosynthesis by periphyton, phytoplankton, and submerged plants. Open areas allowed even more opportunity for photosynthesis as well as surface aeration.

The role of rooted, emergent plants on oxygen transfer to the wetland system is subject to controversy. Because these wetland plants are typically rooted in soils that are anaerobic, they have evolved special airways to allow the efficient movement of atmospheric oxygen to the root system. Dead and broken plant shoots may also allow for transport of some oxygen to the root zone. There is a sufficient body of evidence to show that significant amounts of oxygen are transported down these passages and that other gases, such as carbon dioxide, hydrogen, and methane, may pass upward through these same channels. Gas transfer is the result of humidity-, thermally-, and/or Venturi-induced convective flow as well as diffusion. Gas exchange through the root surface is by diffusion. Although photo-



a) Vertical distribution of DO in a submergent plant zone of the Arcata Enhancement Marsh



b) Vertical distribution of DO in an emergent plant zone of the Arcata Enhancement Marsh

Figure 3-5. Dissolved oxygen distribution in emergent and submergent zones of a tertiary FWS (EPA, 1999)

synthesis does not seem to enhance the concentration of oxygen in the shoots, sunlight can cause convection to increase because light amplifies the degree of stomatal openings in the leaves, and higher temperatures cause steeper diffusion gradients for gases (Armstrong and Armstrong, 1990). A large proportion of the oxygen entering the plant is vented to the atmosphere instead of being used in plant respiration or effluxed to the root system.

A number of studies have been made on the transport of oxygen by plants. Only one field study has been reported on an operating wetland (Brix and Schierup, 1990). They found that for *Phragmites* in both FWS and VCB systems, the oxygen transported almost exactly balanced respiration by the plants. The range of values reported by other investigators is 0 to 28.6 g O₂/m²/d, whereas rates of 0 to 3 g O₂/m²/d were found in 15 of the 23 studies. Kadlec and Knight (1996) pointed out that studies to date infer that oxygen transfer measurements made from BOD and ammonium losses are not accurate. At present, it seems reasonable to presume that plant oxygen transfer is not an important source of oxygen in most wetland systems.

The DO concentration found in FWS systems is dependent on the rate of oxygen transfer and the rate of oxygen uptake. If one equals the other, system DO will remain constant. If respiration exceeds transfer, DO values will fall to zero and anaerobic conditions will prevail. The principle consumers of oxygen (respiration) in wetlands include microorganisms that consume oxygen during normal exogenous and endogenous respiration and plants that carry out respiration when sunlight energy is unavailable as an energy source. Sources of oxygen requirements will include those from influent organic matter, stored organic matter in living biomass (endogenous respiration), dead

plant litter at the surface and bottom of the wetland, dead periphyton and plankton suspended in the water column or residing at the wetland surface or within the benthic deposits, and influent ammonium nitrogen. One factor that should be considered in wetland design is the determination of an oxygen balance. A mass balance on oxygen is difficult to perform in FWS systems owing to the highly complex and dynamic characteristics of the system. An estimate of influent oxygen demand (carbonaceous and nitrogenous) is possible, but uptake due to plant respiration and decomposition of plant carbon is more difficult to predict (Table 3-6). The sources of oxygen are also difficult to quantify as discussed previously. Total coverage of wetlands by emergent plants results in little reliable oxygenation (some oxygen will likely be produced by periphyton near the water surface, but quantification of this is unreliable at the present time). Use of open areas to promote photosynthesis by submerged plant and plankton appears to be a logical approach, but again, quantitative estimates of transfer are difficult to assess based on current data. It should be emphasized that DO is not a steady value in wetlands but will vary in a diurnal fashion with photosynthesis. It is not unrealistic to presume that wide fluctuations in DO will occur, especially in active systems. As will be described later, the DO concentration will also change along the wetland length as demands and supplies change.

FWS Biological Reactions

Influent particulate organic matter may be entrapped within biofilms attached to emergent plant surfaces or accumulated on the wetland floor within the plant litter and sediments (Figure 3-4). Experience suggests that much of this material is accumulated very close to the influent struc-

Table 3-6. Wetland Oxygen Sources and Sinks

Process	FWS		VSB	
	Source	Sink	Source	Sink
Reaeration	+	(*)	+	
Photosynthesis	+			
Plant O ₂ Transpiration	+		+	
Influent BOD _{ult} : (oxid./endog.)				+
Influent NH ₄				+
Plant Respiration		+		+
Plant Decomposition		+		+

(*) may be estimated in some instances

(†) May be calculated for wetland system

ture. In addition, particulate organic matter deriving from dead plant litter accumulates on the floor of the wetland as well as in surface mats. The quantity of this material is dependent on the species of plants growing in the area and their coverage. Emergent plant communities have higher potential production rates than submerged communities (Wetzel, 1983). The accumulated organic debris at the wetland floor degrades at different rates depending on the composition of the organic matter. Influent particulate organic matter from primary settling or septic tank effluents is easily degradable in most environments. Algal cells from pond effluents are biologically less available. Emergent macrophytes produce much more structural material (lignin, cellulose, and hemicellulose) than do submerged and floating leafed plants, and this material degrades relatively slowly (Godschalk and Wetzel, 1978).

Much of the particulate organic matter would be hydrolyzed, producing lower molecular weight organic compounds that are more soluble in water, which leach back into the water column and contribute to the soluble BOD downstream. In the presence of oxygen, these compounds would be oxidized by microbes to CO₂, oxidized forms of nitrogen and sulfur, and water. Under anaerobic conditions, these compounds may be converted to low molecular weight organic acids and alcohols. Under strict anaerobic conditions, methanogenesis may occur whereby these compounds are converted to gaseous end products of CH₄, CO₂, and H₂. In the presence of sulfates, sulfur-reducing microbes will convert these low molecular weight organic compounds to CO₂ and sulfide. Either of these anaerobic reactions will essentially remove organic matter from the system. As the degradability of the material decreases, the decomposition rates slow and the nature of the metabolic end products change. It has been suggested that soluble organic matter has a half-life of about three days while organic sediment may exhibit a half-life on the order of four months (EPA, 1999). The rates of degradation are also temperature dependent. Thus sediment organic matter may accumulate during the colder months and be more rapidly degraded in the spring when water temperatures rise. This increase in degradation will result in an increase in soluble organic matter released to the water column and a concomitant increase in oxygen demand, a phenomenon that has also been observed in facultative ponds for nearly a century.

The result of these metabolic activities is that (1) organic matter concentrations (and oxygen demand) may increase downstream as particulate organic material is solubilized, (2) the effect of temperature on observed organic matter removal may not be as significant in wetlands as would be predicted by typical temperature correction relationships for biochemical reactions, and (3) the organic matter residual downstream is a combination of recalcitrant organic matter in the influent, likely very small, soluble organic compounds released from plant decomposition and particulate organic matter released from dead plant and microbial materials.

The source of the soluble fraction of organic matter in the wetland is, as has been stated, influent to the system and soluble material released from the decomposition of influent particulate matter and dead plant and microbial tissue. This soluble material is most likely sorbed onto plant surface biofilms, although a fraction may be sorbed onto biomass suspended in the water column, and still another fraction will diffuse to the debris at the wetland floor or surface. The sorbed organic matter will be metabolized by organisms associated with the biofilms. The metabolic pathway and the end products of this metabolism will be dependent on the presence or absence of oxygen. As previously described, areas of the wetland populated with dense emergent macrophytes can supply only a small fraction of the oxygen necessary to satisfy demand. Typical wetland profiles in these areas suggest that most of the water column is anoxic, as are the sediments below (small microsites containing oxygen may be found adjacent to active plant roots). The degree of anoxia would be dependent on the organic and nutrient load to the wetland area. Open areas of wetland (containing submerged plants) and the margins adjacent to emergent macrophyte coverage do demonstrate aerobic conditions throughout the wetland depth (again, dependent on organic and nutrient load and type of vegetation).

As described previously, the mechanisms that regulate dissolved organic matter removal in wetlands include biodegradation, sorption, and photolysis. Different operative mechanisms may act on different types of organic matter. As a result, fundamental mechanisms should be considered in wetland designs and operation to enhance removal processes. Wetlands receiving municipal wastewater pond effluents may, for example, produce a net increase in dissolved organic matter (Barber et al., 1999). Details of design strategies for FWS systems based on these observations are found in Chapter 4.

3.3.3 Organic Matter in Vegetated Submerged Beds

Vegetative submerged beds act as fixed-film bioreactors. As described in section 3.2.3, the actual role of plants in these beds is controversial. Some research (Gersberg et al., 1986) has claimed effective results with selected species, but these claims have not been substantiated by others. The presence of a root structure would provide addi-

tional surface for biofilm attachment. Macrophytes may also contribute some oxygen to the granular bed as previously described. Based on that review, rates of oxygen transport by macrophytes range from 0 to 3 g O₂/m²/d. However, it has been found that root penetration in the bed is only partial, and there is a significant amount of flow under the root zone. Furthermore, plant oxygen transfer would be unreliable for a significant portion of the year due to plant senescence.

Particulate organic matter is removed in VSB systems by mechanisms similar to suspended solids separation in horizontal gravel beds with the same media size. The separated solids from the influent wastewater and plant litter would undergo decomposition much the same way as occurs in FWS systems. Hydrolysis will generate soluble compounds. Those compounds and soluble organic matter from the influent to the system or cycled from solids decomposition will most likely sorb to biofilm surfaces attached to the media, plant roots, and plant litter accumulated at the bed surface or within the interstices of the media. Oxygen sources to the VSB would be limited to some small amount of surface aeration and plant-mediated transport. The thatch that accumulates at the bed surface would inhibit or at least slow down surface transport. It is possible that some aerobic metabolism would occur in these beds, but the predominant biological mechanism is likely to be facultative/anaerobic. Typical values of DO in VSB systems are very low (<0.1 mg/L). In VSB systems where ORP has been measured, values were typically quite low, indicating strong reducing conditions (Lienard, 1987). Thus the predominant metabolic pathways are most likely anaerobic. As described previously, the anaerobic pathways leading to BOD removal from the system would be methanogenesis, sulfate reduction, or denitrification, all yielding gaseous end products. These reactions are temperature dependent and therefore are likely to slow down or cease in winter months. As discussed previously, the processes will resume as the water warms up, and high releases of gaseous end products and soluble organic matter may occur. Some clogging of the bed may occur due to accumulation of slowly degradable and recalcitrant solids. Low-loaded systems may exhibit some aerobic reactions, especially near the effluent end of the process. Residual effluent BOD from VSB systems is likely to be somewhat more consistent than that from FWS systems because of the presence of less plant matter in the water column.

3.4 Mechanisms of Nitrogen Separations and Transformations

3.4.1 Description and Measurement

In waters and wastewater, the forms of nitrogen of greatest interest are, in order of decreasing oxidation state, nitrate, nitrite, ammonia, and organic nitrogen. All nitrogen forms are reported in wastewater as nitrogen, N. All of these forms, including nitrogen gas (N₂), are biochemically interconvertible and are components of the nitrogen cycle. Analytically, organic nitrogen and ammonia can be deter-

mined together, and are termed "Total Kjeldahl nitrogen" (TKN). Organic nitrogen in wastewater includes proteins, peptides, nucleic acids, and urea. Organic nitrogen may be found in both soluble and particulate forms. The other nitrogen species are water soluble. Ammonia nitrogen may be found in the un-ionized form, NH₃, or the ionized form, NH₄⁺, depending on water temperature and pH. The ionized form is predominant in wetlands. At 25°C and a pH of 7.0, the % un-ionized ammonia is approximately 0.6%.

The discharge of nitrogen to receiving surface and ground water sources is of concern for a number of reasons. Excessive accumulation of nitrogen in surface waters can lead to ecological imbalances that may cause overgrowth of plants and animals, leading to water quality degradation (eutrophication). High concentration of the un-ionized ammonia species are toxic to fish and other aquatic life. Nitrate and nitrite nitrogen constitute a public health concern, primarily related to methemoglobinemia and carcinogenesis. Ammonia nitrogen may deplete dissolved oxygen in natural waters by way of microbial nitrification reactions. As a result, discharge permits may be written to control any or all species of nitrogen. Most commonly, ammonia or total nitrogen are the target pollutants specified depending on the receiving stream. Typical concentrations of the nitrogen species found in primary, septic tank, and treatment pond effluents are shown in Table 3-1. It should be noted that whereas primary and septic tank effluents would contain organic nitrogen and ammonia, treatment ponds may contain either reduced or oxidized forms of nitrogen depending on loading and season of the year. Organic nitrogen in the latter systems would be primarily associated with algal cells. It is important to note that when evaluating the performance of wetlands relative to nitrogen, both total nitrogen and the species of nitrogen are important. Mass balances must be conducted on total nitrogen species, not on just one or two forms, to generate meaningful data.

3.4.2 Nitrogen in Free Water Surface Systems

3.4.2.1 Physical Separation of Nitrogen Species

There are a number of separation processes that will affect nitrogen species in wetlands. Nitrogen associated with suspended solids (organic nitrogen) may be removed by many of the processes described earlier for the removal of TSS including flocculation, sedimentation, filtration, and interception processes (Figure 3-6). Sorption of both particulate and soluble organic nitrogen may occur on biofilms associated with emergent macrophytes, plant litter, or other detritus at the FWS surface or on the bottom. Ion exchange of ammonium (NH₄⁺) by clay minerals in the wetland soils may play a role in nitrogen separation if this species either diffuses into the soil layer or is biologically produced by the ammonification of organic nitrogen solids located in the benthic layer. The exchange capacity of the clay minerals would be important in this assessment. It must be emphasized that the exchange mineral would have limited

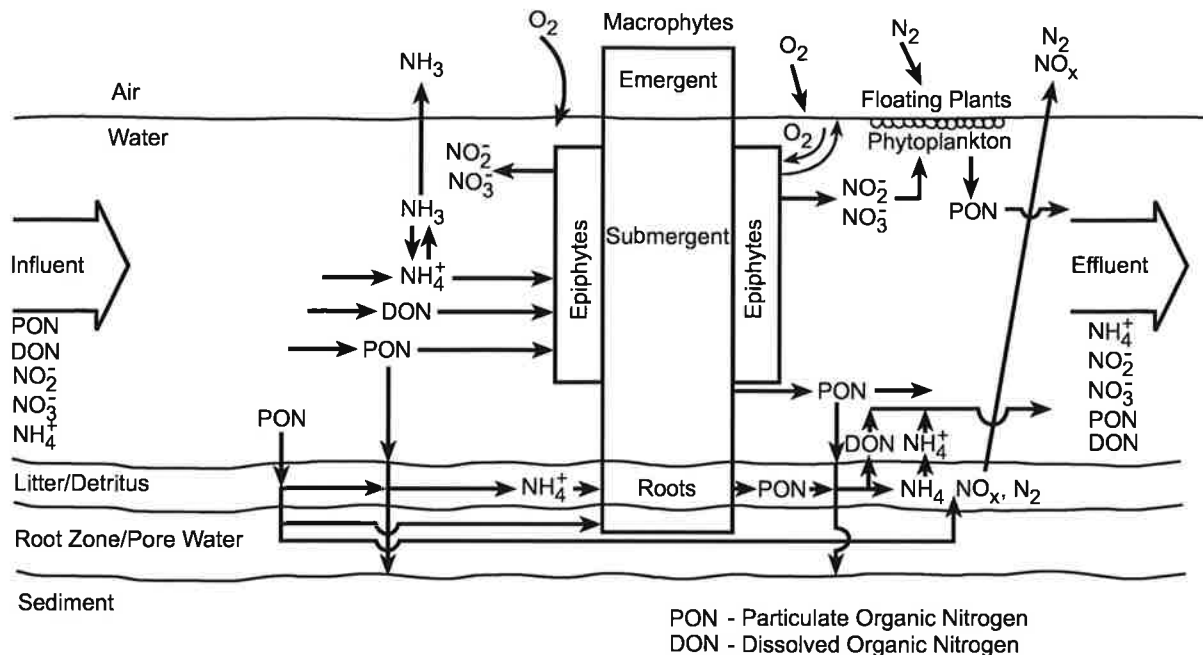


Figure 3-6. Nitrogen transformations in FWS wetlands

long-term capacity unless regeneration by chemical or biochemical action takes place. It is not likely that ion exchange would play an important or dependable role in nitrogen removal after a start-up period in most wetland systems. Furthermore, the native soil layer is buried under detritus and plant litter within a period of time, thereby isolating these clay minerals from the wetland system. Ammonia (NH_3) gas may also be removed from the system by stripping. As discussed previously, the quantity of un-ionized ammonia at neutral pH values is low, but during active photosynthesis in open water zones, pH values may rise to values as high as 8.0 to 8.5 depending on water alkalinity. At that pH, the fraction of NH_3 ($\text{NH}_3/\text{NH}_4^+$) may increase to 20 to 25% at 20°C. If surface turbulence is high due to wind action, significant losses of nitrogen may occur in these open water areas if ammonia concentrations are high. Few, if any, well-controlled studies have been conducted to examine the importance of volatilization losses in FWS systems with open areas.

3.4.2.2 Biologically Mediated Transformations of Nitrogen Species

Ammonification

Almost half of the municipal wastewater nitrogen content, as received at the treatment facility, is in the organic nitrogen form. The rest has usually already been converted to ammonium-nitrogen (EPA, 1993) in the sewer. The biological transformation of organically combined nitrogen to ammonium nitrogen during organic matter degradation is

referred to as ammonification, hydrolysis, or mineralization. The process occurs under aerobic and anaerobic conditions, but has been described as slower for the latter by Mitsch and Gosselink (1993). Other environmental engineering literature, however, does not support any difference in rates under varying oxygen states because of their primary dependence on enzymatic pathways. The rate of this process is primarily dependent on pH and temperature, increasing with increased temperatures. Municipal wastewaters have been demonstrated to be fully hydrolyzed in 19 hours at temperatures of 11° to 14°C (Bayley et al., 1973). Once the ammonium is formed, it can be absorbed by plants through their root systems, immobilized by ion exchange in the sediments, solubilized and returned to the water column, volatilized as gaseous ammonia, anaerobically converted back to organic matter by microbes, absorbed by phytoplankton/floating aquatic macrophytes in the water column, or aerobically nitrified by aerobic microorganisms.

Nitrification

In the presence of dissolved oxygen, microbes in the water column or within the biofilms may convert ammonium to nitrite and nitrate nitrogen in a two-step process. In this process about 4.3g of O_2 are required per g ammonium nitrogen oxidized to nitrate and 7.14 g of alkalinity as CaCO_3 are consumed. The process is temperature and pH dependent (EPA, 1993). The reaction may take place in an aerobic water column by suspended bacteria and

within any aerobic biofilms. Nitrate is not immobilized by soil minerals and remains in the water column or pore water of the sediments. It may be absorbed by plants or microbes in assimilatory nitrate reduction (converted to biomass via ammonium) or may undergo dissimilatory nitrogenous oxide reduction (nitrate reduction pathways referred to as denitrification).

Denitrification

Dissimilatory nitrate reduction or denitrification is carried out by microorganisms under anaerobic (anoxic) conditions, with nitrate as the terminal electron acceptor and organic carbon as the electron donor (EPA, 1993). That is to say, the reaction occurs in the absence of oxygen and requires an organic carbon source. The products of denitrification are N_2 and N_2O gases that will readily exit the wetlands. The denitrification reaction occurs primarily in the wetland sediments and in the periphyton films in the water column below fully vegetated growth where DO is low and available carbon is high. The minimum carbon to nitrate-nitrogen ratio for denitrification would be about 1 g C/g NO_3^- -N. Decomposing wetland plants and plant root exudates are potential sources of biodegradable organic carbon for this purpose. These sources are most readily available at the beginning of senescence. Organic carbon will be consumed (satisfying some oxygen demand: approximately 2.86 g O_2 per g nitrate nitrogen reduced) and alkalinity is produced (approximately 3.0 g $CaCO_3$ alkalinity per g nitrate nitrogen reduced). The process is temperature and pH dependent. Denitrification in the sediments may supply N_2 for fixation by bacteria and for plant uptake in the root zone (nitrogen fixation) if the system is nitrogen-poor. The remainder will remain in equilibrium with N_2 in the water column. The nitrogen gas in the water phase may be available for nitrogen fixation by some periphyton and phytoplankton. There will also be an air-water interchange of N_2 . The losses to the air represent nitrogen losses from the system, and these are greater in open water than in fully vegetated zones.

Nitrogen Fixation

Nitrogen gas may be converted to organic nitrogen by way of selected organisms that contain the enzyme nitrogenase. The reaction may be carried out aerobically or anaerobically by bacteria and blue-green algae. Nitrogen fixation occurs in the overlying water in FWS open water zones, in the sediment, in the oxidized rhizosphere of the plants, and on the leaf and stem surfaces of plants (Reddy and Graetz, 1988). It may be a significant source of nitrogen in natural wetlands but is not important in systems treating wastewater in which nitrogen is plentiful.

Plant Uptake (Assimilation)

Wetland plants will assimilate nitrogen as an important part of their metabolism. Inorganic nitrogen forms are reduced by the plant to organic nitrogen compounds used for plant structure. During the growing season, there is a

high rate of uptake of nitrogen by emergent and submerged vegetation from the water and sediments. Increased immobilization of nutrients by microbes and uptake by algae and epiphytes also lead to a retention of inorganic forms of nitrogen in the wetland. Estimates of net annual nitrogen uptake by emergent wetland plant species vary from 0.5 to 3.3 gN/m²/yr (Burgoon et al., 1991). Reeds and bulrushes are at the lower end of this range, whereas cattails are at the higher end. Estimates for epiphytes and microbes in wetland systems have not been found. During the active growth period, a significant amount of the total plant nitrogen is in the stems and leaves above the sediments. During senescence, the nitrogen translocates back to the roots and rhizomes for storage. However, a substantial portion of the nitrogen is lost to the water column through litter fall and subsequent leaching. This generally leads to a net export of nitrogen in the fall and early spring. The extent of recycling of nitrogen within the wetland is dependent on nitrogen loading to the system. Treatment wetland systems are considered as eutrophic wetlands with excessive nutrient levels. As a result, intrasystem cycling is less important to the treatment process than it would be if the hydrologic regime were more varied (Twinch and Ashton, 1983).

3.4.2.3 Nitrogen in Free Water Surface Wetlands

Figure 3-6 illustrates the highly complex series of reactions for nitrogen in FWS systems. Particulate organic nitrogen entering the wetland as wastewater influent or produced in the wetland by plants is separated. It may be found associated with biofilms attached to plant structures in the water column, the wetland sediment, or in floating litter and detritus. The biodegradable compounds will be ammonified by aerobic or anaerobic organisms associated with the biofilms and sediment surfaces. The recalcitrant organic nitrogen will accumulate and eventually become a part of the deep sediments.

Ammonium released from the particulate organic nitrogen in the sediments is available to the emergent and submerged macrophytes as an important nutrient. Uptake occurs during the growing season, which increases the concentration gradient and the release of more ammonium. Excess ammonia may remain in reserve in the sediment and leach from the sediment into the water column, where it may undergo biological oxidation (nitrification) under aerobic conditions. Release of ammonium into the water column in the fall and early spring is not an unusual phenomenon in wetlands. The leached ammonium may be taken up by epiphytes or plankton found in the water column or be attached to emergent and floating plants. Nitrification of ammonium requires DO and is therefore limited to areas of the wetland where oxygen is available. There may be some nitrification occurring adjacent to plant rhizomes where oxygen leaks from the plant. The relative importance of this pathway in wetlands is minor in treatment wetlands because most sediments below emergent canopies are anaerobic. Little nitrification would be expected in these regions of the wetland. In the water col-

umn near the surface in open areas, oxygenation may be sufficient to ensure significant nitrification. The important variable in sizing an open water zone of a FWS system for nitrification is organic plus nitrogenous loading. More precisely, it is the oxygen demand loading (carbonaceous plus nitrogenous oxygen demand [CBOD + NOD]) to each wetland zone that will dictate whether oxygen is present. Typically, nitrification will not be initiated until a majority of the organic compounds have been removed. Thus, nitrification in the water column would not be expected in the initial settling zone, but could occur in subsequent open water/aerobic zones.

The nitrate produced by nitrification or introduced with the system influent (e.g., from oxidation ponds achieving nitrification) may be taken up by periphyton or plankton. Small amounts produced within any aerobic sediments would be taken up by plant roots or may diffuse upward into the water phase. Under anaerobic conditions and in the presence of organic matter, microbes associated with attached biofilms or suspended in the water column may convert nitrate to nitrogen gases (NO_2 , N_2) via denitrification. Some nitrate will also diffuse into the sediments where it is available for plant uptake or can be denitrified as well.

Moving downstream from the wetland influent, the reactions of nitrogen could be expected to occur sequentially such that total nitrogen levels should drop in the settling zone (owing to separation of organic nitrogen), followed by ammonia release, nitrification, and denitrification. Plants will attenuate this sequence by releases and uptake throughout the annual growth/senescence cycle. Systems loaded at a level such that oxygen demand exceeds oxygen supply will not exhibit significant nitrification. Seasonal change as well as influent variability will greatly impact system performance. Highly nitrified influent from pretreatment systems may provide excellent nitrogen removal during warm seasons when sufficient organic matter is available (primarily from plant decomposition) for denitrification. Nitrogen release may be significant in fall and early spring seasons during plant senescence and death. The background nitrogen values found in Table 3-5 reflect contributions by internal recycling of nitrogen within the system.

In open water zones of FWS systems, elevated pH and water temperature may enhance $\text{NH}_3\text{-N}$ volatilization to the degree that it becomes a significant removal mechanism. This mechanism has been shown to reach levels as high as 50% or more under optimum conditions in stabilization ponds, but FWS open water zones are smaller in size, therefore minimizing this pathway under normal conditions (EPA, 1983).

Wastewater discharge permits are normally written so as to limit effluent ammonia concentrations (either seasonally or all year) or total nitrogen concentrations. For ammonia removal, the processes that will achieve effective removal include plant uptake, nitrification, volatilization, and ion exchange. The latter two typically have only minor impact in most FWS systems. Plant uptake is sea-

sonal and requires harvesting prior to plant senescence. Fortunately, seasonal nitrogen uptakes may parallel ammonia restrictions in those cases in which these restrictions are based on summer oxygen demands and/or certain game fish maximization. Generally, the designer must be concerned with achieving reliable ammonia removal by means of nitrification. This may be achieved at low loading (oxygen demand) with sequencing closed and open wetland areas (See Chapter 4). It should be noted that nitrification is temperature dependent, so that rates will significantly slow in winter months, especially in colder climates.

Nitrogen removal may be achieved by plant uptake/harvesting, nitrification/denitrification, volatilization, and ion exchange. Again, the latter two are considered to be of minor consequence in most FWS systems. Plant uptake and harvesting requires careful system management and can be costly. The requirement for denitrification requires nitrification as explained previously plus adequate decaying plant organic carbon in a region free of dissolved oxygen. Sequential designs are also best to achieve this goal (See Chapter 4). Note that temperature affects both nitrification and denitrification so that rates can be significantly reduced during the colder months, which may control design requirements.

3.4.3 Nitrogen in Vegetated Submerged Beds

As described in section 3.3.3, VSB systems incorporate anaerobic fixed-film biological reactions. Organic nitrogen trapped within the bed will undergo ammonification. The released ammonia may be available for plant uptake depending on the location of plant roots. Flow below the plant roots will carry ammonium downstream. Plant uptake (0.03 to 0.3 $\text{g/m}^2/\text{d}$) of nitrogen is low compared to typical nitrogen loading to VSB systems. As described previously, dependence on plant uptake for nitrogen removal requires harvesting and is not effective during plant senescence and death.

Oxygen sources in VSB systems are negligible, and it is most likely there will be insufficient oxygen to promote reliable nitrification in all but the most lowly loaded systems. Any nitrification occurring may be found in the root zone adjacent to rhizomes or near the bed surface where some surface oxygen transfer might occur. If nitrification occurs, it would occur downstream where oxygen demand is lowest.

Conventional VSB systems would seem to be well suited for denitrification of nitrified influents. These beds are anaerobic. However, they require a supply of organic carbon from decomposing plant residue entrapped within the bed or aerobically decomposed products of plant biomass at the bed surface, which may also leach into the anaerobic zones during rainfall events. The supply of carbon is seasonal, however, since it would be highest after plant senescence. Low temperature will slow the process during the winter months.

From this discussion, it is clear that conventional VSB systems do not represent reliable, cost-effective systems for ammonia removal. To improve, the loading to the system would necessarily have to be low. Nitrogen removal from well-nitrified influents to the system may be possible, but seasonal availability of carbon may create carbon limitations that should be considered in the design (See Chapter 5).

3.5 Mechanisms of Phosphorus Separations and Transformations

3.5.1 Description and Measurement

Phosphorus occurs in natural waters and wastewater primarily as phosphates. They are classified as orthophosphates, condensed (pyro-, meta-, and poly-) phosphates, and organically bound phosphates. They may be in solution or particulate form. Organic phosphates are formed primarily by biological processes and are found in raw wastewater as food residues and body wastes and in treated wastewater as living or nonliving biota (e.g., algae and bacteria from treatment ponds). Inorganic phosphorus found in wastewater most often comes from various forms of personal and commercial cleaning solutions or from the treatment of boiler waters. Storm waters carry inorganic forms of phosphorus from fertilizers into combined sewers. Classification of phosphorus is based on a variety of analytical methods. The typical concentrations of phosphates in influent wastewaters to a treatment wetland appear in Table 3-1. Modern P concentrations are ~50% of those shown for septic tank effluent in this table. Table 3-3 indicates that the major fraction of these phosphate forms are in the colloidal range, and Munch et al. (1980) indicated that 80% of the phosphate was split almost equally between colloidal and supracolloidal fractions.

Phosphorus is one of the most important elements in ecosystems. It is often the major limiting nutrient in freshwater systems. Since there is no important gaseous component in the biogeochemical cycle, phosphorus tends to move to the sediment sink in natural systems and become scarce in the ecosystem. In fact, it is the accretion of mineral phosphates and biomass in the sediment that is the primary mechanism for phosphorus removal in the wetland environment.

3.5.2 Phosphorus in Free Water Surface Systems

3.5.2.1 Physical/Chemical Separations of Phosphorus

Particulate phosphate may be deposited onto the FWS system sediment by sedimentation or entrapped within the emergent macrophyte stem matrix and attached (sorbed) onto biofilms (Figure 3-7). Soluble phosphate may be sorbed onto plant biofilms in the water column, onto biofilms in the floating plant litter, or onto the wetland sediments. The exchange of soluble phosphate between sediment pore water and the overlying water column by diffusion and sorption/desorption processes is a major pathway for soluble phosphates in wetlands. In the sediment pore wa-

ter, these phosphates may be precipitated as the insoluble ferric, calcium, and aluminum phosphates or adsorbed onto clay particles, organic peat, and ferric and aluminum oxides and hydroxides. The precipitation as calcium phosphates occurs at pH values above 7 and may occur within the sediment pore water or in the water column near active phytoplankton growth where pH values may rise well above 7. The sorption of phosphorus on clays involves both the chemical bonding of the negatively charged phosphates with positively charged clay and the substitution of phosphates for silicates in the clay matrix (Stumm and Morgan, 1970). Phosphate can be released (desorbed) from the metal complexes depending on the redox potential of the sediment. Under anoxic conditions, for example, the ferric compound is reduced to the more soluble ferrous compound and phosphate is released. Phosphates may also be released from ferric and aluminum phosphates under anoxic conditions by hydrolysis. Phosphate sorbed to clays and hydrous oxides may also be resolubilized through the exchange of anions. The release of phosphate from insoluble salts will also occur if the pH decreases as a result of the biological formation of organic acids, nitrates, or sulfates. Over time, however, a significant fraction of the initially removed phosphate will become bound within the sediments and lost to the system. At the start-up of a FWS system (possibly for more than one year), the phosphorus removal will be abnormally high owing to the initial reactions with the soils of the wetland. This removal mechanism is finite and essentially disappears after this period.

3.5.2.2 Biological Transformations of Phosphates

Dissolved organic phosphate and insoluble inorganic and organic phosphate are not usually available to plants until transformed to a soluble inorganic form. These transformations may take place in the water column by way of suspended microbes and in the biofilms on the emergent plant surfaces and in the sediments. Uptake of phosphates by microorganisms, including bacteria, algae, and duckweed, acts as a short-term, rapid-cycling mechanism for soluble and insoluble forms. Cycling through the growth, death, and decomposition process returns most of the phosphate back into the water column. Some phosphate is lost in the process due to long-term accretion in newly formed sediments. Uptake by the macrophytes occurs in the sediment pore water by the plant root system. The estimate of net annual phosphorus uptake by emergent wetland species varies from 1.8 to 18 g P/m²/y (Burgoon et al., 1991). The cycle of uptake and release is similar to that of the microbes, but these reactions operate over a longer time scale of months to years. Uptake occurs during the growth phase of the plant and release occurs during plant senescence and death in the late summer and fall, followed by decomposition in the plant litter. Again, some phosphate is lost to the system through accretion processes within the sediments.

3.5.2.3 FWS System Reactions—Phosphate

Sustainable phosphate removal in a FWS system involves the accretion and burial of phosphate within the

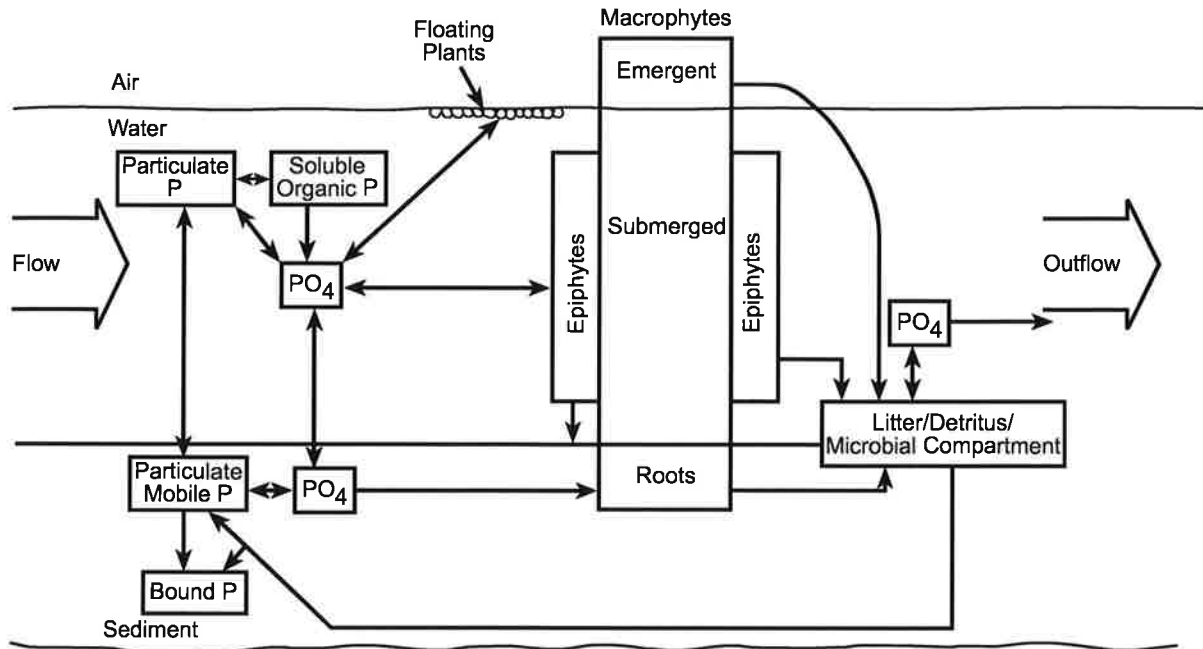


Figure 3-7. Phosphorus cycling in a FWS wetland (adapted from Twinch and Ashton, 1983)

wetland sediments (Figure 3-7). Phosphate cycling and storage involves a complex set of processes with a number of forms of phosphate. Insoluble organic and inorganic phosphates are settled or captured on solid surfaces within the water column or in the wetland sediments or floating litter. Many of these insoluble forms may be chemically and biologically transformed to available forms of phosphate for uptake by macrophytes, epiphytes, and floating plants. The phosphate taken up by these biological systems is recycled back into the system and is subsequently available for other organisms or may leave the system through the water column. The undecomposed portion of the biological growths may accumulate and thereby be removed from the system as accreted sediment. This material along with any recalcitrant phosphate separated from the water column and accumulated within the sediment represents the total net phosphate removal from the system.

Phosphate removal in FWS systems follows a seasonal pattern in most temperate climate conditions. The form of phosphate, the type and density of the aquatic plants, the phosphate loading rate, and the climate determine the pattern and amount of phosphate removed from the wetland over any given time period. Aquatic plants serve as the seasonal reservoir for phosphate as they take up soluble reactive phosphate (SRP) during the growing season. There is a finite amount of SRP that can be incorporated in the aquatic plants, epiphytes, and plankton in the water column. In climates where senescing of plants occurs in the fall, the majority of the phosphorus taken up will

be released back into the water column (Figure 3-8). In this figure, during the second year Marsh 1 received tap water without phosphorus, whereas Marsh 3 received wastewater at a loading rate of 0.15 kg P/ha/d throughout. Release in excess of influent phosphorus is noted in the Marsh 3 effluent in the fall. The effluent phosphorus exhibited for Marsh 1 is the result of release from the standing crop developed the year before. Note a background residual phosphorus concentration of about 0.5 mg/L SRP for this system. Maximum removal of phosphate was found to be about 1.5 mg/L at a loading of less than 1.5 kg PO₄/ha/d and reduced to negligible (<0.2 mg/L) at loadings above 5 (Gearheart, 1993). This maximum is consistent with the theory of Stumm (1975), which suggested approximately 20% of influent P could be removed under an equilibrium condition in a lake.

3.5.3 Phosphorus in Vegetative Submerged Beds

The removal of phosphate from VSB systems relies on accretion of phosphorus from decomposing plants and from separated, recalcitrant phosphate from the influent to the process. Phosphate loading to these systems is large relative to plant uptake, and reliable sustained removal by harvesting of plants prior to senescence would not provide significant removal. Accretion of partially decomposed plant tissue may provide some additional removal of phosphorus. Cycling of phosphorus will produce seasonal effluent variations similar to those seen for FWS systems. Some minerals associated with the media can provide tempo-

rary removal by means of precipitation/exchange/sorption mechanisms, but these effects would be short term (<1 year) and dependent on the source of the granular materials.

3.6 Mechanisms of Pathogen Separations and Transformations

3.6.1 Description and Measurement

Waterborne pathogens including helminthes, protozoans, fungi, bacteria, and viruses are of great concern in assessing water quality. Since routine examination for pathogenic organisms is not recommended because of cost and the low numbers of a specific pathogen present at any given time, indicator organisms are used. The most common indicators of the level of waterborne pathogen contamination in water are the coliform group. Today, the fecal coliform test is considered to be a better indicator of human fecal contamination than the more general total coliform procedure. Even so, the fecal coliform test is not specific and can produce false positive results for human contamination, since these organisms are excreted by a number of warm-blooded animals including those residing in wetland environments. Fecal streptococci analysis may also be used as an additional indicator of fecal pollution. Together with the fecal coliform test, these two procedures are sometimes used to discriminate between human and other warm-blooded animals. Table 3-1 indicates typical ranges of the indicator organisms in typical influents to treatment wetland systems.

Separation of pathogens (and indicators) from the water column does not in itself mean that the organisms are no longer viable. They may be released from the matrix to

which they are attached and become available again in the water column as infectious agents. The true removal of pathogens is only achieved by rendering them nonviable.

3.6.2 Fate in Constructed Wetlands

Pathogens (and indicators) entering wetlands may be incorporated within the TSS or may be found as suspensions in the influent wastewater. Those associated with TSS would be separated from the water column by the same mechanisms as discussed for TSS (sedimentation, interception, and sorption). Once separated, the viable organisms may be released from the solid matrix and be retained within the biofilm or sediment pore-water, or they may be reentrained into the water column. Regardless of their location, they must compete with the consortium of organisms surrounding them. As intestinal organisms, they will normally require a rich substrate and high temperature to favorably compete. Most will not survive in this competition. They will also be destroyed by predation or, if near the open water surface, by UV irradiation.

Removal of pathogens (indicators) in wetlands appears to be correlated with TSS removal and hydraulic residence times (Gearheart et al., 1999; Gersberg et al., 1989). Few studies have been performed on the effect of wetlands on specific pathogens, but Gearheart has found similar removals to FC with Salmonella and MS2 coliphage. Many pathogens are more sensitive to the wetland environment than indicators, but some viruses and protozoans (spores) may be more resistant. Erratic results have been reported on viruses, and mechanisms affecting their removal may be different than those that destroy indicators.

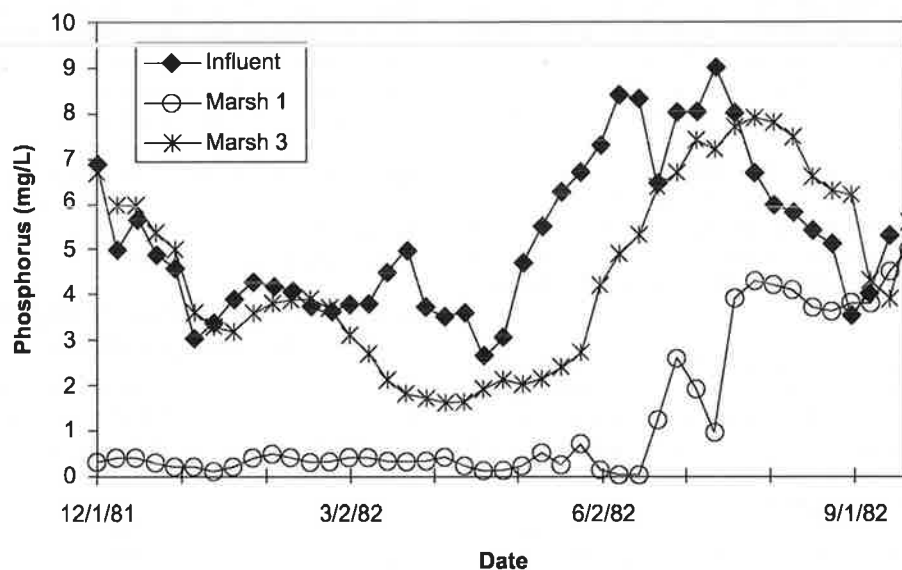


Figure 3-8. Phosphorus pulsing in pilot cells in Arcata; Marsh 1 received tap water until June 1982 (no phosphorus load), while Marsh 3 received oxidation pond effluent (Gearheart, 1993)

It is significant to note that indicator organisms and perhaps pathogens may be generated within the wetland. Thus background levels of indicators will be found even in natural wetland systems (see Table 3-5). These background levels are variable, influenced by season and other operational parameters of the system (Figure 3-9). It should be noted that in general these indicator organisms are not from human sources. However, constructed wetlands are unlikely to consistently meet stringent effluent fecal coliform permit levels. Therefore, regulators may require disinfection of treatment wetland effluents prior to discharge. Gearheart (1998) consistently attained an FC count of less than 2/100 mL with UV disinfection of FWS effluent.

3.7 Mechanisms of Other Contaminant Separations and Transformations

3.7.1 Metals

While some metals are required for plant and animal growth in trace quantities (barium, beryllium, boron, chromium, cobalt, copper, iodine, iron, magnesium, manganese, molybdenum, nickel, selenium, sulfur, and zinc), these same metals may be toxic at higher concentrations. Other metals have no known biological role and may be toxic at even very low concentrations (e.g., arsenic, cadmium, lead, mercury, and silver) (Gersberg et al., 1984; Crites et al., 1997). Influent wastewater to wetlands may carry metals as soluble or insoluble species.

Metals entering wetlands as insoluble suspended solids are separated from the water column in a manner similar to TSS. Depending on pH and redox potential, these insoluble species may be resolubilized and returned to the liquid phase. Important removal mechanisms for metals include cation exchange and chelation with wetland soils and sediments, binding with humic materials, precipitation

as insoluble salts of sulfides, carbonates, and oxyhydroxides, and uptake by plants, algae, and bacteria. The chemically bound metals may eventually become buried in the anoxic sediments where sulfides occur. These bound metals are often not bio-available and remain removed from the system. If sediments are disturbed or resuspended and moved to oxic regions of the wetland, sequestered metals may resolubilize.

Metals may be incorporated into the wetland biomass by way of the primary production process. For macrophytes, metals are taken up through the root system and distributed through the plant. The extent of uptake is dependent on the metal species and plant type. Gersberg et al. (1984), found only minor uptake by plants in VSB systems, while others claim that metals can be found on root surfaces due to precipitation and adsorption. The accumulation of heavy metals was found to be variable in a marsh in New Jersey receiving wastewater (Simpson et al., 1981; 1983). Cadmium, copper, lead, nickel, and zinc had accumulated in the litter at the end of the growing season in much higher concentrations than in the live vegetation. Other studies have shown that metals like cadmium, chromium, copper, lead, mercury, nickel, and zinc can be sequestered by wetland soils and biota or both (Mitsch and Gosselink, 1993). The high uptake of selenium by biota in a wetland marsh receiving irrigation waters was discussed in Hammer (1992), but some could have been volatilized. Studies have shown that some algae will sequester selected metals (Kadlec and Knight, 1996). Floating plants such as duckweed have been shown to be excellent accumulators of cadmium, copper, and selenium, but only moderate accumulators for chromium and poor accumulators for nickel and lead (Zayed et al., 1998). A review of metal removal in wetlands is found in Kadlec and Knight (1996).

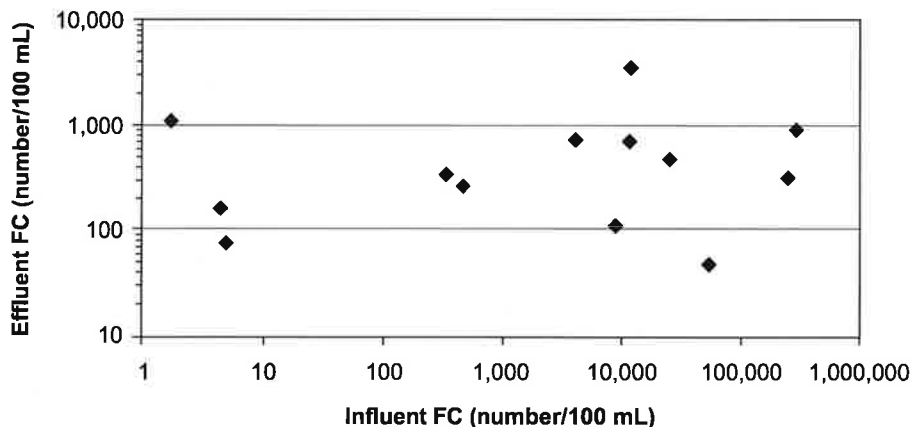


Figure 3-9. Influent versus effluent FC for the TADB systems (EPA, 1999)

At the present time there is insufficient long-term data on full-scale constructed wetlands to provide a reliable estimate of performance on the removal of metals from wastewater. However, in VSBs and in fully vegetated FWS systems, the anaerobic conditions are conducive to retaining most metals with the settled TSS and minimizing resolubilization. Similarly, the actual removals will be affected by the speciation of the influent metals.

3.7.2 Other Organic Compounds

There is concern about the fate of many trace organic compounds in the environment. These include pesticides, fertilizers, process chemicals, and others that fall under the category of priority pollutants. The fate of these compounds in wetlands is dependent on the properties of the compound, the characteristics of the wetland, the species of plants, and other environmental factors. The most important separation and transformation mechanisms involved include volatilization, sedimentation/interception, biodegradation, adsorption, and uptake. These mechanisms have been discussed previously. Recalcitrant organics that have been separated may accumulate in the wetland sediments. Some may be taken up by plants and be returned to the system upon plant decomposition. Biodegradation of some organic compounds may result in completely mineralized end products, or the process may produce end products that may be more toxic than the parent compound. At this time, there is insufficient data available on full-scale wetland systems to evaluate how effective they are in the long-term removal and destruction of most priority pollutants. Based on pretreatment performance, oxidation or facultative lagoons remove a high %age of volatile and semivolatile organic compounds (Hannah et al., 1986), resulting in low influent concentrations to the FWS system that follows, while primary sedimentation is less effective and results in higher influent concentrations of both to subsequent VSB systems.

3.8 Constructed Wetland Modeling

3.8.1 Modeling Concepts

The modeling of wastewater treatment operations and processes has long been of interest to environmental engineers. This interest stems primarily from a need to quantify the performance of the process and a desire to optimize the design and operation of the treatment facility. Modeling of many of the treatment processes used today has met with only partial success primarily because of the lack of rigor in most models. This is due to the enormous complexity of the reaction mechanisms that may take place within many of these systems and with the difficulty in characterizing the constituents within the wastewater. Constructed wetlands fall in this category of a highly complex system in which a multiplicity of reactions and reaction mechanisms occur, even in the simplest of systems. Adsorption, sedimentation, flocculation, biological catalysis, precipitation, exchange, and diffusional processes are but a few of the important functional mechanisms that may control the removal of a given constituent. Furthermore, these mechanisms are dependent on a number of physi-

cal, chemical, and biological variables within the system (e.g., temperature, redox potential, pH, plant density, etc.).

It is apparent that in a highly complex system such as the constructed wetland, the quantification of all specific rate-controlling mechanisms seems unlikely. The transient nature of the influent wastewater characteristics and the lack of substantial control over the process undoubtedly will result in frequent changes of the rate-controlling mechanisms of the process.

In developing a model for any process, the first question that should be asked is, "What is the value of modeling this particular system?" Currently, the design engineer may be using empirical models that assist in interpolating information from lab-scale or pot-scale studies. The major problem is scale-up, and most of the designer's time is spent on concerns about operating conditions within rather narrow ranges in order to meet permit requirements. Added to that is the ever-present shortcoming of analytical and sampling methods. The answer to the question would appear to be that there is little value in developing more empirical curve-fitting models for the process. The design engineer might be well advised at the present time to develop performance parameters, curves, and operational charts that could be used for the plants under investigation. If a deterministic model of mechanistic proportions is to be developed, it needs to be developed through a series of rigorous processes ensuring that it is, in fact, a true model of the process.

Writing a mechanistic, mathematical model is generally easier than verifying it. That is not to say that conceiving and writing the model is trivial, but rather to emphasize the difficulty in giving the model a fair chance to fail the experimental test. Note that the emphasis is on a chance for verification failure rather than a chance to pass. Thus an investigator's problem of ownership of a particular model presents itself, which is not easily subjugated to the scientific issue of fairly and rigorously testing the model.

The experimental learning process is basically iterative and consists of successive and repeated use of the sequence. Box and Hunter (1965), although not the first to note this important underlying pattern in experimentation, have best exploited the pattern and developed strategies for experimentation that efficiently lead one through the cycle and advise one in determining the details of subsequent cycles. One such cycle is illustrated in Figure 3-10. In environmental engineering, a field that relies heavily on empirical methods, the unavoidable long-term character of the experiments required for a system, such as a constructed wetland, has resulted in many different individuals conducting rather inefficient iterations of different parts of the problem. As a result, the development of a rigorous model of the process, or parts of it, has not been achieved as is true with many of the wastewater treatment processes designed today.

Of particular importance in the iterative sequence are the steps of design and analysis. In this context, design is

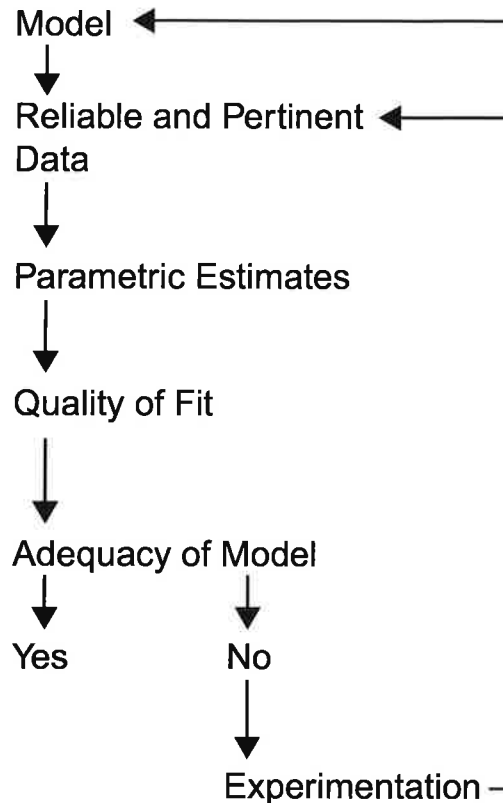


Figure 3-10. Adaptive model building

devising experiments suggested by the current status of the process that will most likely improve an understanding of it. Analysis would be the examination of the data in such a manner as to discover how far conjectures are born out and spark modified or new conjectures when the old ones are found wanting. Both engineering and statistics play an important role in the process.

3.8.2 Status of Wetland Modeling

What is the status of model building for constructed wetlands at this time? There are a number of ways one might classify models. One classification would include linguistic models, stochastic models, and deterministic models. Linguistic, or word, models are qualitative and have as their main advantage the capability of representing incomplete states of knowledge not explicitly represented by the other two types of models. Stochastic models of processes are the result of data-driven, top-down approaches to modeling and can reflect information contained in the data used to prepare them. These models are useful but are data intensive and require that the data be representative of the behavior of the process that they are designed to model. Deterministic models, both empirical and mechanistic, are either built from the bottom up based on first principles or result from careful observation of phenomena. They are robust and general, and are effective provided that the data are available to support the theory and to calibrate the model.

An examination of the literature on constructed wetlands suggests that all three of these models have been proposed or used. Yet it is worth noting that none have really met the test of the iterative process. There are very few full-scale studies of constructed wetlands that have provided a database sufficient to demonstrate success or failure of a given model. Most studies lack sufficient spatial and temporal sampling to even identify whether a model fails the experimental test of verification. In an effort to provide more data, investigators use databases from a number of sites. Site-to-site variability makes this process suspect. Quality control on the data collected is also of concern. For the most part, the data fit to constructed wetlands is regressed from empirical models, and fit is expressed in terms of the coefficient of determination, R^2 . It is important to note that a high value of R^2 does not assure a valid relation nor does a low value mean that the model is useless. It is often stated that R^2 explains a certain proportion of the variability in the observed response. If the data were from a well-designed controlled experiment, with proper replication and randomization, it is reasonable to infer that a significant association of the variation in y with variation in the level of x is a causal effect of x . If, however, as in the case of most wetland data, the data are observational, there is a high risk of a causal relationship being wrong. With observational data, there can be many reasons for associations among variables, only one of which exhibits causality. Totally spurious correlations, often with

high R² values, can arise when unrelated variables are combined.

Often rival models may be tentatively considered for a constructed wetland process. It is not uncommon to find that more than one model can be calibrated to fit the data and give residual errors that are acceptable. In some cases, the selection of the seemingly acceptable model is of little practical consequence over the range of interest. In other cases, knowing which model is better may throw light on fundamental questions about reaction mechanisms and other phenomena under investigation. A fundamental concept in model discrimination is that rival models often diverge noticeably only at extreme conditions. Thus extremes must be evaluated to provide useful statistical information. Models must be put into jeopardy of failing. An excellent discussion of this may be found in Berthouex and Brown (1994).

In summary, it appears premature, given the lack of quality-assured data, for designers of constructed wetlands to rely on regressed empirical models. The problem is one of extrapolation of these mostly "black box" models from site to site and extension of the model outside of the database. Examination of the wide variation in parameter values (reaction coefficients, background concentrations, etc.) suggests that fitting data to simplistic models may be insufficient at this time to provide reliable design information in most cases. Currently the design of these systems should be based on design parameters (e.g., hydraulic loading, nitrogen loading, detention time, etc.) and operating criteria that are required to meet a specific effluent limitation. This is not a novel approach, but has been used for many decades by environmental engineers in the design of highly complex unit processes including the activated sludge process and waste stabilization ponds. Only when a carefully designed series of iterative studies have been conducted, and data based on quality-controlled specifications have been analyzed, can rigorous models be provided for use in wetland system design.

Currently there is a North American Database (NADB) on wetlands that has been relied on for purposes of wetland design. Efforts have been made to refine that database to improve reliability. What is urgently needed at this time is an effective plan for the design of studies that will provide a comprehensive understanding of the processes that occur within wastewater wetlands. Efforts have already been made to mathematically model some of the wetland processes based on first principles. These models should serve as the starting point for the adaptive iterative process as described in Figure 3-10. The experimental design should include extensive, quality-assured, transect data at numerous selected sites (spatial variations) over an extended period of time (temporal variations). Characterization of the wastewater must include both particulate and soluble fractions of contaminants and must ensure quality control of both sampling and analyses. Characterization of the wetland is also important and should include data on residence time distribution of flow, geometry, plant species and distribution, monolithic zone coverage and

distribution, and so forth. Once this database is developed, the iterative modeling of this very complex system can begin in earnest. Given the number of years of constructed wetland experience, such efforts are generally overdue.

3.9 References

- Armstrong, J. and W. Armstrong. 1990. Light enhanced connective throughflow increases oxygenation in rhizomes & rhizospheres of *Phragmites australis* (Cav.). *Trin. Ex. Steud., New Phytologist*, 114:121.
- Barber, L., et al. 1999. Transformation of dissolved organic carbon in constructed wetland systems. Project Report, U.S. Dept. Interior, Bureau of Reclamation.
- Bayley, R.W., E.V. Thomas, and P.F. Cooper. 1973. Some problems associated with the treatment of sewerage by non-biological processes. In: Applications of new concepts in physical-chemical wastewater treatment. W.W. Eckenfelder and L.K. Cecil (eds.). Oxford, UK: Pergamon Press, pp. 119–132.
- Bella, D. 1970. Simulating the effect of sinking and vertical mixing of algae population dynamics. *J. Water Poll. Cont. Fed.* 42(2):R140.
- Berthouex, P.M. and L. Brown. 1994. Statistics for environmental engineers. Boca Raton, FL: Lewis Publications Inc., 287 pp.
- Box G.E.P. and W.G. Hunter. 1965. The experimental study of physical mechanisms. *Technometrics*, 7:23.
- Brix, H. and H. Schierup. 1990. Soil oxygenation in constructed reed beds: The role of macrophyte and soil-atmosphere interface oxygen transport. In: P.F. Cooper and B.C. Findlater (eds.) Proceedings of international conference on use of constructed wetlands in water pollution control. Oxford, UK: Pergamon Press.
- Burgoon, P.S., K.R. Reddy, T.A. DeBusk, and B. Koopman. 1991. Vegetated submerged beds with artificial substrates. II: N and P Removal. *Journal ASCE-EED*, 117(4):408–424.
- Camp, T.R. and P.C. Stein. 1943. Velocity gradients and internal work in fluid motion. *J. Boston Soc. Civ. Eng.*, 30:209.
- Crites, R.W., et al. 1997. Removal of metals and ammonia in constructed wetlands. *Water Environment Research*, 69(2).
- Gearheart, R.A. 1993. Phosphorus removal in constructed wetlands. Paper No. AC93-023-001. Presented at the 66th Annual WEFTEC Meeting, Anaheim, CA.
- Gearheart, R.A. 1998. The use of free surface constructed wetland as an alternative process treatment train to meet unrestricted water reclamation standards. In: AWT98 Proceedings, p. 559.

- Gearheart, R.A. and B.A. Finney. 1996. Criteria for design of free surface constructed wetlands based upon a coupled ecological and water quality model. In: Proceedings of 5th International Conference on Wetland Systems for Water Pollution Control. IAWQ, Vienna, Austria.
- Gearheart, R.A., et al. 1983. City of Arcata marsh pilot project, effluent quality results—System design and management. Project No. C-06-2270. State Water Resources Control Board, Sacramento, CA.
- Gearheart, R.A., F. Klopp, and G. Allen. 1989. Constructed free water surface wetlands to treat and receive wastewater: Pilot project to full scale. In: Constructed wetlands for wastewater treatment, D.A. Hammer (ed.) Chelsea, MI: Lewis Publishers, Inc., pp. 121–137.
- Gearheart, R.A., et al. 1999 [In draft]. Free water surface wetlands for wastewater treatment: A technology assessment. U.S. Environmental Protection Agency, Office of Water Management, U.S. Bureau of Reclamation, Phoenix, AZ.
- Gersberg, R.M., et al. 1984. The removal of heavy metals by artificial wetlands. In: Proceedings Water Reuse Symposium, III. Vol. 2. AWWA Research Foundation, p. 639.
- Gersberg, R.M., et al. 1986. Role of aquatic plants in wastewater treatment by artificial wetlands. *Water Research* 20(3):363.
- Gersberg, R.M., R.A. Gearheart, and M. Ives. 1989. Pathogen removal in constructed wetlands. In: Proceedings from First International Conference on Wetlands for Wastewater Treatment. Chattanooga, TN, June 1988. Ann Arbor, MI: Ann Arbor Press.
- Godschalk, G.L. and R.G. Wetzel. 1978. Decomposition in littoral zones of lakes. In: R.E. Good et al. (eds.) *Freshwater wetlands: ecological process and management potential*. New York, NY: Academic Press.
- Grady, Jr., C.P.L. and H.C. Lim. 1980. *Biological wastewater treatment—Theory & applications*. New York, NY: Marcel Dekker, Inc.
- Hammer, D.A. 1992. *Creating freshwater wetlands*. Chelsea, MI: Lewis Publishers, Inc., 298 pp.
- Hannah, S.A., B.M. Austern, A.E. Eralp, and R.H. Wise. 1986. Comparative removal of toxic pollutants by 6 wastewater treatment processes. *Jour. WPCF*, 58(1):27–34.
- Heukelekian, H. and J.L. Balmat. 1959. Chemical composition of the particulate fractions of domestic sewage. *Sewage Ind. Wastes*, 31(4):413.
- Hutchinson, G. 1967. *A treatise on limnology*. Vol. 2. New York, NY: John Wiley & Sons.
- Kadlec, R.H. and R.L. Knight. 1996. *Treatment wetlands*. Boca Raton, FL: Lewis-CRC Press.
- Levine, A.D., G. Tchobanoglous, and T. Asano. 1984. Characterizations of the size distribution of contaminants in wastewater: Treatment and reuse implication. 57th Annual Conference Water Pollution Control Federation, New Orleans, LA.
- Levine, A.D., G. Tchobanoglous, and T. Asano. 1991. Size distribution of particulate contaminants in wastewater and their impact on treatability. *Wat. Res.*, 25(8):911–922.
- Lewin, R.A. (ed.) 1962. *Physiology & biochemistry of algae*. New York, NY: Academic Press, 751 pp.
- Liehr, S.K. 2000. Constructed wetlands treatment of high nitrogen landfill leachate. WERF Report No. 94-IRM-U. NCSU.
- Lienard, A. 1987. Domestic wastewater treatment in tanks with emergent hydrophytes: Latest results of a recent plant in France. *Water Sci. Tech.*, 19(12):373–375.
- Metcalfe and Eddy. 1991. *Wastewater engineering*. 3d ed. New York, NY: McGraw-Hill, Inc.
- Mitsch, W.J. and J.G. Gosselink. 1993. *Wetlands*. New York, NY: Van Nostrand Reinhold.
- Munch R., C.P. Hwang, and T.H. Lackie. 1980. Wastewater fractions add to total treatment picture. *Water Sew. Wks.*, 127:49–54.
- O'Connor, D.J. and W.E. Dobbins. 1958. Mechanism of reaeration in natural streams. *Trans. Amer. Soc. Civil Eng.*, 123:641.
- Reddy, K.R. and D.A. Graetz. 1988. Carbon and nitrogen dynamics in wetland soils. In: D.D. Hook et al. (eds.) *The ecology and management of wetlands*. Vol. I. Portland OR: Timber Press, p. 307.
- Reed, S.C., R.W. Crites, and E.J. Middlebrook. 1995. *Natural systems for waste management and treatment*. 2d ed. New York, NY: McGraw-Hill.
- Rickert, D.A. and J.V. Hunter. 1972. Colloidal matter in wastewater secondary effluents. *J. Water Pollution Control Federation*, 44(1):134.
- Rose, C. and W.G. Crumpton. 1996. Effects of emergent macrophytes and dissolved oxygen dynamics in a prairie pothole wetland. *Wetlands*, 16(4):495.
- Simpson R. L., et al. 1981. Dynamics of nitrogen, phosphorus, and heavy metals in Delaware River freshwater tidal wetland. U.S. Environmental Protection Agency, Final Report, Corvallis Environmental Research Lab, Corvallis, OR.

- Simpson, R.L., et al. 1983. The ecology of freshwater tidal wetlands. *Bioscience*, 33:225.
- Standard methods for the examination of water and wastewater. 1998. 20th ed. APHA, AWWA, WEF.
- Stumm, W. 1975. Man's acceleration of hydrogeochemical cycling of phosphorus: Eutrophication of inland and coastal waters. *Water Pollution Control (GB)*, pp. 124–133.
- Stumm, W. and J.J. Morgan. 1970. *Aquatic chemistry: An introduction emphasizing chemical equilibria in natural waters*. New York, NY: John Wiley & Sons, p. 583.
- Twinch, A.J. and P.J. Ashton. 1983. Wetlands as accreting systems: Nutrient cycling in wetlands. *Jour. Limnol. Soc. Sc. Afr.*, 9(2):104–109.
- U.S. Environmental Protection Agency (EPA). 1978. Design manual—Onsite wastewater treatment and disposal systems. EPA 625/1-80-012. Office of Research and Development, Municipal Environmental Research Laboratory, Cincinnati, OH.
- U.S. Environmental Protection Agency (EPA). 1980. Wastewater stabilization lagoons intermittent sand filtration systems. EPA 600/2-80-032. Municipal Environmental Research Laboratory, Cincinnati, OH.
- U.S. Environmental Protection Agency (EPA). 1983. Wastewater stabilization ponds—Nitrogen removal. Office of Water, Washington, D.C.
- U.S. Environmental Protection Agency (EPA). 1993. Manual—Nitrogen control. EPA/626/R-93/010. Office of Research and Development, Washington, DC.
- U.S. Environmental Protection Agency (EPA). 1999. Free water surface wetlands for wastewater treatment: A technology assessment. EPA 832/R-99/002. Office of Water, Washington, DC.
- Van Oostrom, A.J. and R.N. Cooper. 1990. Meat processing effluent treatment in surface flow and gravel bed constructed wastewater wetlands. In: P.F. Cooper and B.C. Findlater (eds.) *Constructed wetlands in water pollution control*. Oxford, UK: Pergamon Press.
- Watson J.T., F.D. Diodata, and M. Launch. 1987. Design and performance of the artificial wetlands wastewater treatment plant at Iselin, PA. In: K.R. Reddy and W.H. Smith (eds.) *Aquatic plants for water treatment and resource recovery*. Orlando, FL: Magnolia Press.
- Wetzel, R.G. 1983. *Limnology*. 2d ed. New York, NY: Saunders College Press.
- Young, T.C., A.G. Collins, and T.L. Theis. 2000. Sub-surface flow wetland for wastewater treatment at Minoa, NY. Clarkson U. Report to NYSERDA and U.S. EPA.
- Zayed, A., E. Lytle, and N. Terry. 1998. Phytoaccumulation of trace elements by wetland plants: I. Duckweed. *Environ. Quarterly*, 27:715.

Chapter 4

Free Water Surface Wetlands

There are many design factors which effect the effluent quality from a free water surface (FWS) constructed wetland. Consideration of some of these factors can significantly reduce the effluent variation. Site specific factors which need to be considered in the design of wetlands include topography, climate (growing season, temperature variation, evapotranspiration and precipitation), wastewater characteristics, flows and loads, and wildlife activity (Gearheart and Finney, 1996). Design variables include total area, the number, size, depth, and shape of wetland cells, hydraulic retention time, vegetation types and coverage, inlet and outlet type and location, and internal flow patterns.

This chapter provides a brief summary of expected wetland treatment performance based on the most reliable data from existing operating wetlands, describes issues that are important in the design and layout of a FWS constructed wetland, and provides an overall strategy for sizing a constructed wetland system. Several design examples are included, and construction issues unique to FWS wetland systems are discussed.

4.1 Performance Expectations

4.1.1 Introduction

The performance of operating FWS constructed wetland treatment systems reveals the range of effluent quality and the variability of performance possible with these types of systems. Evident in this analysis is the great variety in the range of treatment capacities, and thus the loadings, to which FWS treatment wetlands are subjected. Given the wide variety of settings, design criteria, configuration, and inlet/outlet (I/O) placement, considerable variation in performance should be expected. The largest single compilation of FWS wetland operating data is the North American Database (NADB, 1993). Unfortunately, much of the data within the NADB is difficult to use for performance evaluation because of the absence of hydraulic description of the system's influent and effluent flows. Another major constraint is the lack of intra-cellular and individual cell influent and effluent water quality data. The 40 systems included in the detailed portion of this performance evaluation are known as the Technology Assessment (TA) sites (USEPA, 1999). For purposes of this design manual only those sites treating oxidation pond effluent and primary treated effluent are considered. There are 22 sites in this

category (designated DM sites), which are used to assess loading versus effluent concentration. The data sets employed in this analysis are from Arcata, Gustine and Manila, CA, Beaumont, TX, Brookhaven, NY, Columbia, MO, Fort Deposit, AL, Mount Angel, OR, Ouray, CO, West Jackson County, MS, and Listowel, Ontario, Canada.

The brief performance summary included here offers an overview of loading, influent and effluent ranges for a number of water quality constituents, and presents the observed relationship between loading rates and effluent quality for all systems. A more broad performance review, including cumulative effluent probability plots for the 40 TA sites is provided in FWS Wetlands for Wastewater Treatment: A Technology Assessment (USEPA, 1999). The focus of this manual for FWS application in a strictly non-tertiary treatment mode resulted in the need to cull out those tertiary applications from the TADB to produce the (DMDB) database which is used herein. In all cases, after the DMDB is used to analyze the information, the TA database is evaluated along with other mechanistically viable, controlled studies and/or mechanistic analyses to produce the most reasonable engineering interpretations of the data. The additional quality-assured data which are needed to advance the understanding of the free water surface constructed wetlands are described at several locations in the text of this chapter.

4.1.2 Range of Operating Conditions and Performance

Table 4-1 shows the mean and range of loadings for each water quality constituent for the 22 DM systems included in this analysis. Preliminary treatment for the 22 DM systems includes 21 lagoon systems and one primary effluent system. This first level of assessment is useful only in the context of summarizing the range of performance and operating conditions of these FWS constructed wetlands and their range of response in terms of effluent concentration. This level of analysis summarizes the wide range of applications and expected performance for operating FWS treatment wetlands. No accounting for geometric configuration, planting strategy, inlet/outlet works, climate, etc., is made at this time.

The data in Table 4-1 are a summary of the treatment effectiveness, and are not meant to suggest a mass bal-

Table 4-1. Loading and Performance Data for Systems Analyzed in this Document (DMDB).

Constituent	Pollutant Loading Rate (kg/ha-day)			Influent (mg/L)			Effluent (mg/L)		
	Min	Mean	Max	Min	Mean	Max	Min	Mean	Max
BOD ₅	2.3	51	183	6.2	113	438	5.8	22	70
TSS	5	41	180	12.7	112	587	5.3	20	39
NH ₄ -N	0.3	5.8	16	3.2	13.4	30	0.7	12	23
TKN	1.0	9.5	20	8.7	28.3	51	3.9	19	32
TP	—	—	—	0.56	1.39	2.41	0.68	2.42	3.60
FC	—	—	—	42000	73000	250000	112	403	713

BOD = Biochemical Oxygen Demand (5 day)
 TSS = Total Suspended Solids
 NH₄-N = Ammonia Nitrogen
 TKN = Total Kjeldahl Nitrogen
 TP = Total Phosphorus
 FC = Fecal Coliform, cfu/100mL

ance of constituents, e.g., not all systems reported all constituents.

4.1.3 BOD Performance

The relationship between average biochemical oxygen demand (BOD) loading and average BOD effluent concentration for the studied systems is shown in Figure 4-1. There is a general trend between increased BOD loading and increased effluent concentration up to the highest loading of 183 kg/ha-day if only the fully vegetated designs are taken into account. The figure reveals considerable effluent variation for a given BOD loading and shows considerable variation in effluent quality at the lower BOD loading rates. The effect of the background BOD, due to release from previously settled influent TSS and plant decomposition is especially evident in systems with low loading rates. Figure 4-2 illustrates the internal BOD load which occurs from the partial anaerobic digestion of previously settled organic solids and plant exudates and other byproducts of anaerobic biodegradation. The portion of that internal loading which is due to the plant detritus has been measured and is illustrated in Figure 4-3. Since anaerobic processes are extremely sensitive to temperature, these internal loadings begin in the spring as water temperature rises and continue until the backlog of settleable organics and plant detritus accumulated over the winter is exhausted. Plant exudates and senescent byproducts occur in their own cycles which provide internal loading to the system in a dynamic manner. Background BOD concentrations can range up to almost 10 mg/L.

A more conservative analysis of Figure 4-1 indicates that a fully vegetated FWS should not be loaded above 40 kg BOD/ha-d if a secondary effluent BOD standard (30 mg/L) is to be met. Restricting the analysis to open water FWS systems indicates that loadings up to 45 kg/ha-d yielded effluent BOD of less than 20 mg/L, and loadings up to 130 kg/ha-d always met this quality. However, there is only one data point above 45 kg/ha-d and it is at 130 kg/ha-d. The open water FWS systems which permit reaeration and aerobic oxidation should be designed for an areal loading of no more than 60 kg/ha-d to consistently attain an efflu-

ent BOD of <30 mg/L until more performance data are obtained. Coincidentally, Stowell (1988) recommended an upper limit of 60 to 70 kg BOD/ha-d to prevent odors from an FWS system. Open water FWS systems loaded below 45 kg/ha-d can be expected to attain effluent BODs of 20 mg/L or less. Analysis of the TADB yields a similar maximum areal BOD loading rate of 50 kg/ha-d without differentiation between fully vegetated and open water FW systems (EPA, 1999).

4.1.4 TSS Performance

The effectiveness of FWS treatment wetlands to remove total suspended solids (TSS) is recognized as one of their principal advantages. Over a range of loadings from 5 to 180 kg/ha-day, there are several relationships between loading and effluent TSS quality with the DM data, as shown in Figure 4-4. Under a fairly narrow range of solids loadings, (up to 30 kg/ha-d) secondary effluent TSS concentrations (≤ 30 mg/L) can be attained with fully vegetated systems. Since physical processes dominate the removal of TSS, similar designs should produce similar effluent qualities. Analysis of the TADB (EPA, 1999) yields similar maximum loading.

TSS removal is most pronounced in the inlet region of a FWS constructed wetland. Generally, the influent TSS from oxidation pond systems are removed in the first 2 to 3 days of the nominal hydraulic retention time in fully vegetated zones near the inlet (Gearheart, et al, 1989; Reed, et al, 1995; Kadlec and Knight, 1996). Enhanced settling and flocculation processes account for most of this removal, and the overall removal efficiency is a function of the terminal settling velocity of the influent and flocculated solids. Long-term removal of detrital material will likely be required 10-15 years into operation. The separated solids undergo anaerobic decomposition, releasing soluble dissolved organic compounds and gaseous by-products, carbon dioxide and methane gas, to the water column. Figure 4-2 shows the reduction of total and soluble BOD and TSS through a pilot project wetland cell. Approximately 80% of the TSS is removed in the first two days of theoretical HRT primarily due to enhanced sedimentation and flocculation.

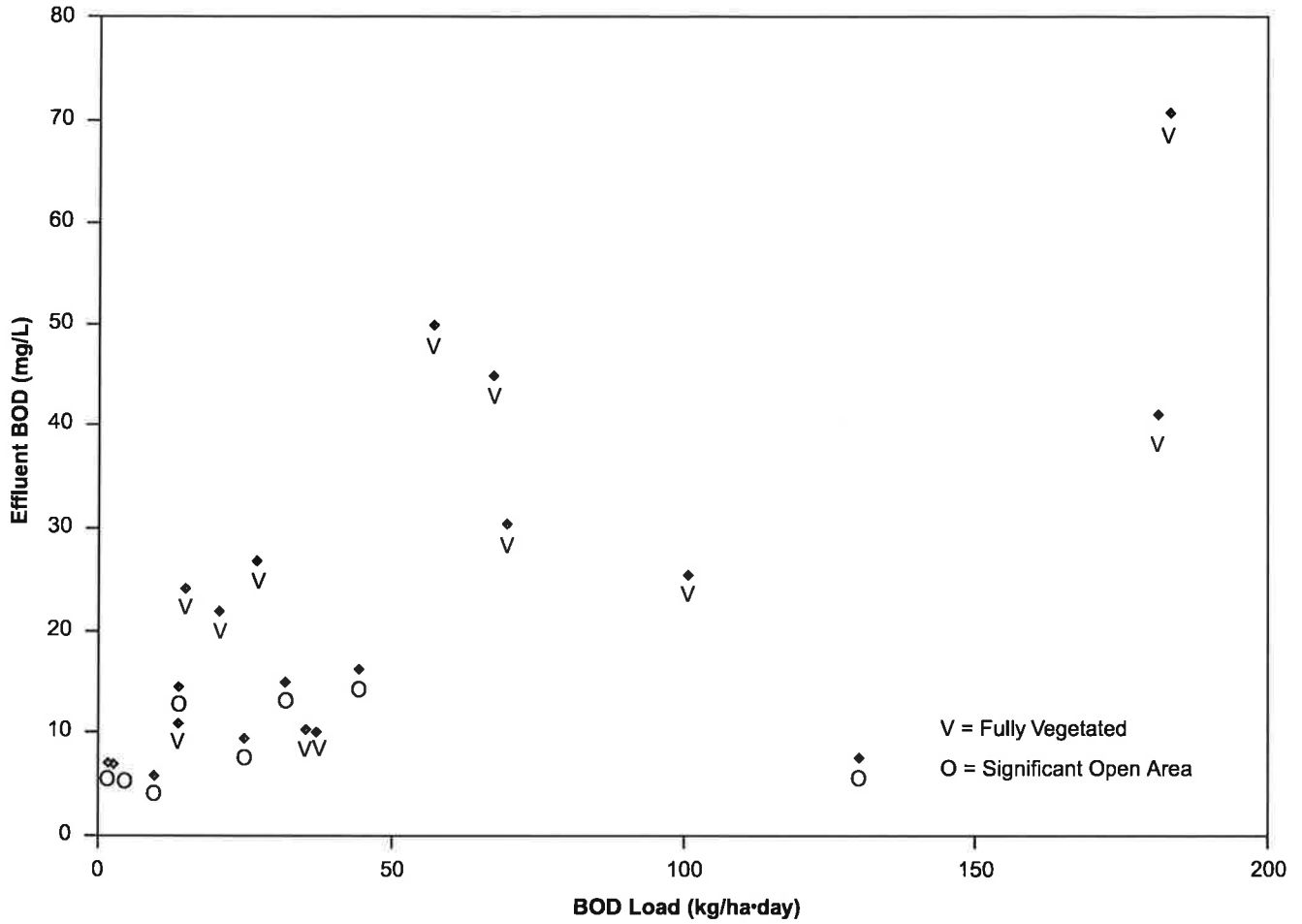


Figure 4-1. BOD effluent vs. areal loading (DMDB)

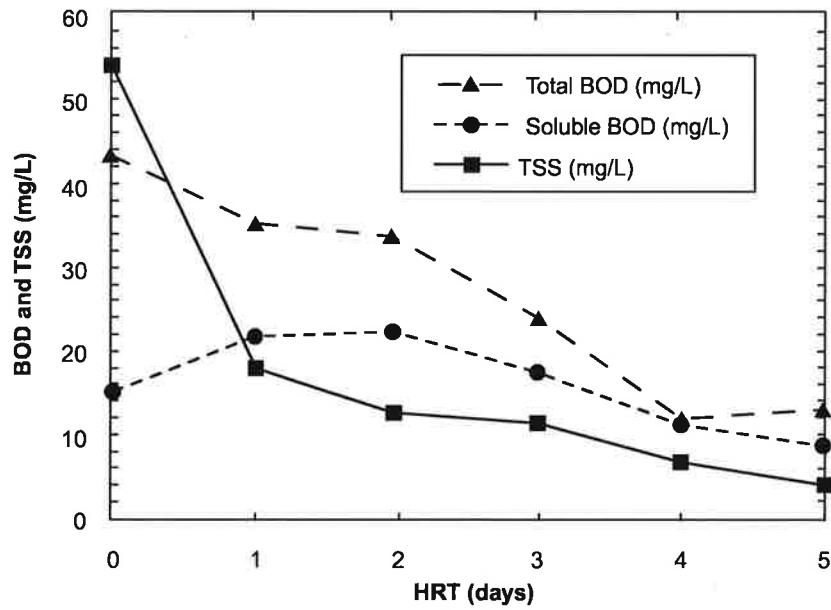


Figure 4-2. Release of soluble BOD during early stage

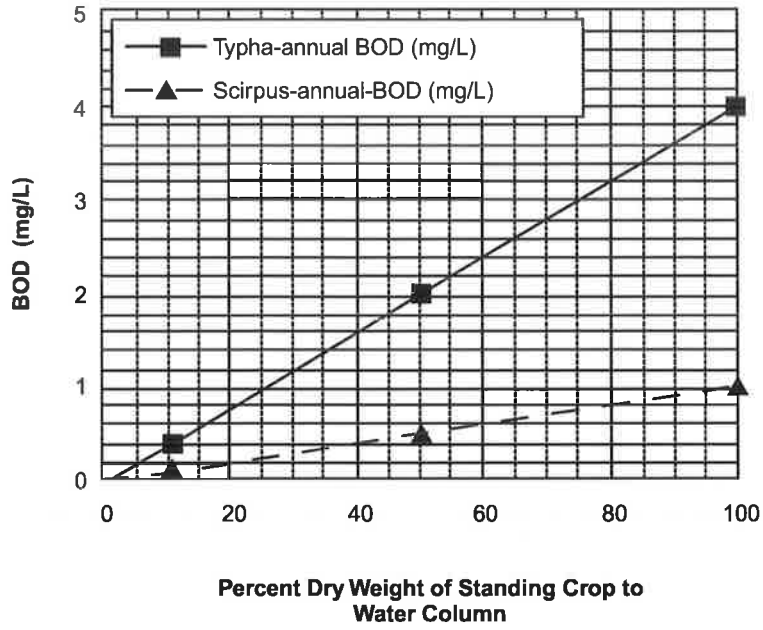


Figure 4-3. Annual detritus BOD load Scirpus and Typha - assuming 15,000 kg/Ha standing crop (Gearheart & Finney, 1996)

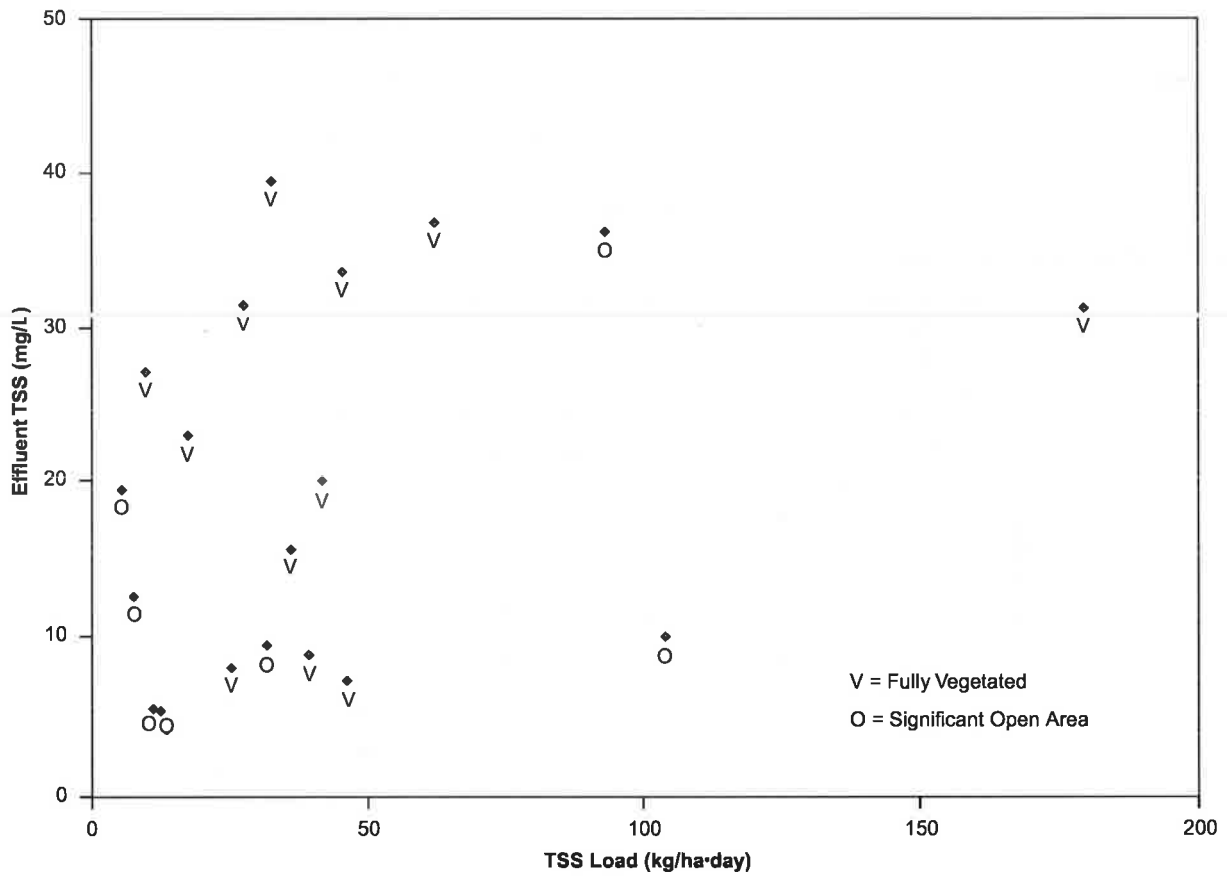


Figure 4-4. TSS loading vs. TSS in effluent (DMDB)

Subsequently, the removal essentially ceases without subsequent open zones which can provide conditioning and transformation processes which may improve overall removal of TSS attainable by the system.

A closer analysis of the DMDB again shows that TSS loadings can be higher for FWS systems with open-water zones. Only one very small site with such zones exceeded secondary effluent TSS standards (30 mg/L), and it was loaded at more than 90 kg/ha-d. Below a loading of 30 kg/ha-d an effluent of 20 mg/L of TSS was consistently achievable. It is therefore recommended that in addition to that areal loading limitation a maximum loading of 50 kg/ha-d be employed to attain an effluent of 30 mg/L of TSS until more performance data can be obtained.

4.1.5 Nitrogen Performance

Any discussion of nitrogen species in FWS constructed wetlands must be predicated by a return to first principles, as described in Chapter 3. Given the numerous transformation possibilities and the dearth of removal mechanisms, there are only a few meaningful explanations. Influent nitrogen for the typical applications of this manual will be primarily in the form of ammonia-nitrogen (NH₄-N) with a significant organic nitrogen (ON) contribution. Approximately 10 to 15% of the oxidation pond effluent TSS due

to algae is organic nitrogen (Balmer and Vik, 1978). Since both are measured by the total Kjeldahl nitrogen (TKN) test, it becomes the likely standard of areal loading analysis. Any discussion of just one species (typically, NH₄-N) is of little value and often misleading to readers.

Another key discussion point is the inherent inability of fully vegetated FWS systems to nitrify a typical FWS influent, as described in the preceding paragraph, within a practical number of days of HRT. During periods of senescence when fully vegetated zones become partially open-water zones, different mechanisms of treatment can replace these which dominate during the normal growing season, if the climate can sustain them. This is further reinforcement for the fact that there are few absolutes in natural systems. Sadly, these conditions are rarely recognized or adequately described and measured, making use of most existing data sets open to some question. However, in this analysis the fact that a system is classified as either fully vegetated or as having significant open-water zones aids in explaining many anomalies.

4.1.5.1 TKN Performance

Figure 4-5 illustrates that for a fully vegetated FWS which receives 30 to 50 mg/L of TKN the effluent exceeds 24 mg/L since the only removal mechanism is sedimentation

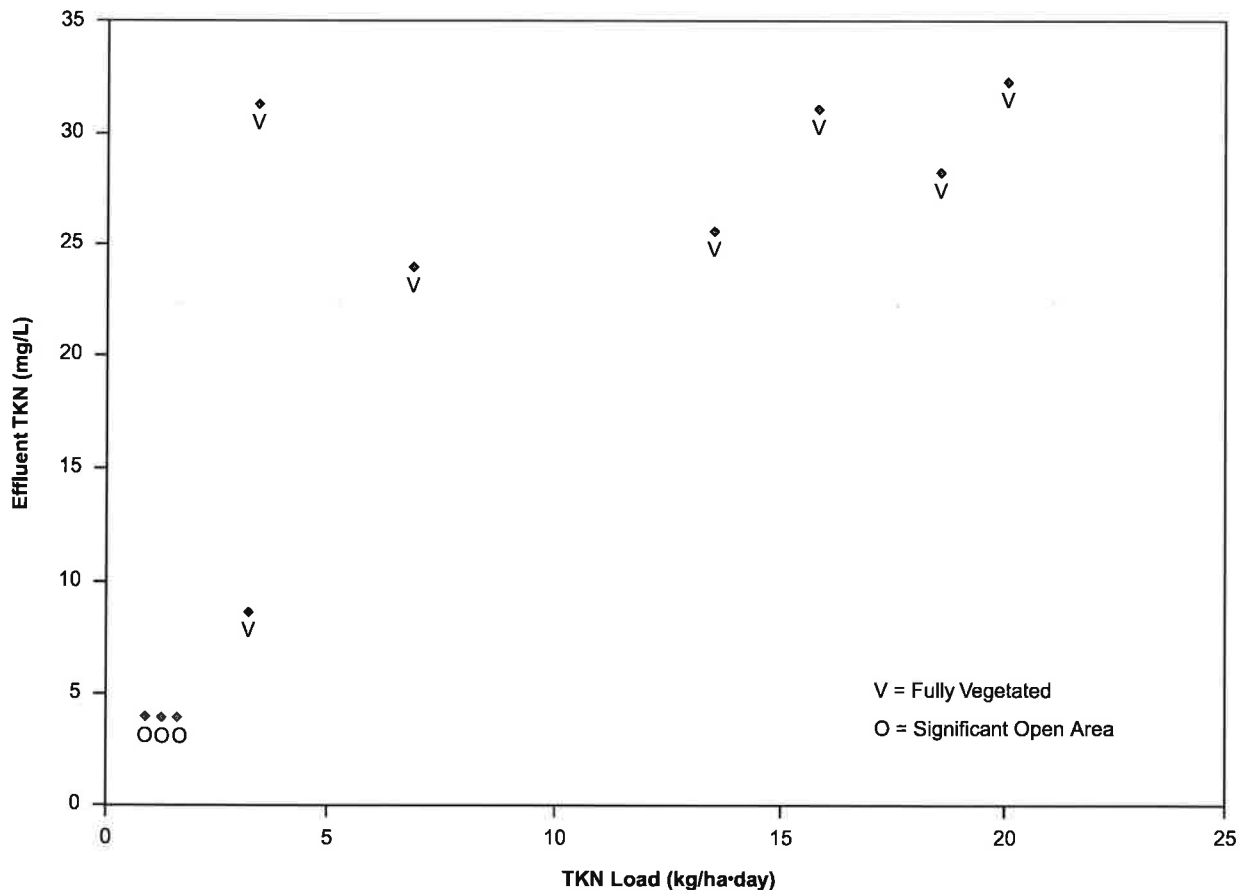


Figure 4-5. Effluent TKN vs. TKN loading

of organic nitrogen (ON). One more lightly loaded (3.3 kg/ha-d) fully vegetated system did produce an effluent TKN of about 9 mg/L. The three open-water zone systems were all lightly loaded (< 2.8 kg/ha-d) and produced effluent TKN of about 4 mg/L. Since these latter designs offer a mechanism to transform the TKN to nitrate-nitrogen (NO₃-N), which could subsequently be removed through denitrification, they could conceivably be loaded more heavily and still meet a stringent total nitrogen standard (e.g., 10 mg/L). No more heavily loaded systems were indicated in the DMDB. The TADB analysis (EPA, 1999) did indicate that any FWS system which received a TKN loading of less than 3.3 kg/ha-d could meet an effluent TKN of less than 10 mg/L, but does not subdivide results into the two subcategories used herein. Arcata's open-water-zone systems have been able to maintain effluent total nitrogen (TN) below 5 mg/L at loadings of up to 3 kg TN/ha-d (Gearheart, 1995) through the denitrification provided near the FWS system outlet which is fully vegetated. Maximum TKN loadings to sustain an effluent TKN of less than 10 mg/L can conservatively be set at 5 kg/ha-d until more data are made available. This only applies to open water FWS systems, while fully vegetated systems are limited to only a small percentage of TKN removal due to the settling of organic nitrogen particulate matter.

4.1.5.2 Denitrification

The extent of nitrate removal via denitrification is dependent on the extent of the prior conversion of TKN to NO₃-N, a labile carbon or other energy source and anaerobic/anoxic conditions in the water column. Therefore, denitrification, which converts NO₃-N to gaseous end products which can leave the constructed wetland, is best suited to a fully vegetated condition. Further, any NO₃-N which enters a FWS wetland is likely to be quickly removed, while any nitrate formation (nitrification), which occurs in the open-water zones of the FWS can be removed near the fully vegetated outlet zone if the conditions noted above are met. The DMDB offers no assistance in that all the systems which had nitrate-nitrogen in their influent had it at very low concentrations (average = 2.47 mg/L), even though effluent concentrations were lower (average = 2.22 mg/L).

Gearheart (1995) reports that the carbon produced from decaying macrophytes is sufficient to denitrify 100 mg NO₃-N/L in an FWS and that the reaction rate is temperature dependent, signifying its biological nature. Reed, et al (1995) and Crites and Tchobanoglous (1998) also indicate that FWS systems have the capability to denitrify, but they offer no specific examples. Therefore, denitrification should be feasible in FWS systems as long as there is sufficient detention time in fully vegetated zones with anaerobic/anoxic conditions.

4.1.5.3 Ammonia Nitrogen Performance

Also, as noted previously, ammonia-nitrogen (NH₄-N) limits are often specified for treatment facilities in their NPDES permit. However, the level of effluent ammonia in an FWS constructed wetland effluent bears only a tenu-

ous relationship to its influent NH₄-N concentration. The normal case will find that all influent nitrogen is measured as TKN, and that this total will be divided between organic nitrogen and NH₄-N. It is likely that this total nitrogen will be reduced in any FWS owing to the loss of organic nitrogen due to enhanced settling. In the DMDB the average TKN removal was 32%, while the fully vegetated systems reported 28%. This difference is not larger because the open-water FWS systems were few in number and were all loaded more lightly. Although one can plot the effluent NH₄-N vs NH₄-N loading from the DMDB, the data demonstrate no useful relationship. Therefore, unless a FWS is designed for very low TKN loadings with an ample open-water zone to nitrify the influent, there is no meaningful chance to meet any NH₄-N effluent standard which is significantly lower (>30%) than the influent concentration.

4.1.5.4 Other Nitrogen Performance

Since total nitrogen is the sum of all forms of nitrogen, it will be reduced through nitrification/denitrification, the loss of organic nitrogen due to flocculation and sedimentation and plant uptake of NH₄-N. Since some of this settled fraction will return to the mainstream as the settled organics partially digest and the plant uptake will return due to senescence, the total nitrogen budget should be evaluated on an annual basis. The returned nitrogen will likely be in the same two forms (organic and ammonia-nitrogen) as the normal influent TN load, making this internal load very compatible with the external load. Given the transformability of individual nitrogen components between each other based on the conditions existing at different locations in the FWS wetland, the designer needs to provide passive controls (e.g., depth and vegetation patterns) if he or she wishes to remove a substantial portion of the incoming nitrogen load.

4.1.6 Total Phosphorus Performance

Only 4 of the DMDB systems measured TP loadings and effluent quality, as shown in Figure 4-6. While some approximate comparisons can be made, the need to separate the inorganic phosphorus performance from the organic particulate phosphorus performance makes the lack of DM data impossible to utilize effectively, therefore, the TA database (EPA, 1999) is used for an approximate analysis.

Figure 4-7 shows that over a range of loading up to 4.5 kg/ha-day at the TADB sites, total phosphorus effluent concentration generally increased with loading (USEPA, 1999). At the lower loading rates (<0.55 kg/ha-d), however, the effluent phosphorus concentration was less than 1.5 mg/L. The fractional distribution of TP in municipal wastewater previously treated by lagoons is variable and has not been well documented. Balmer and Vik (1978) found filtered P/total P to be 20-25%, but the flocculation and sedimentation superiority of the initial FWS fully vegetated zone will remove a significant % of those forms which enter as supracolloidal and settleable solids. Gearheart (1993) has performed extensive studies on the Arcata FWS systems and found a relationship between areal loading and phos-

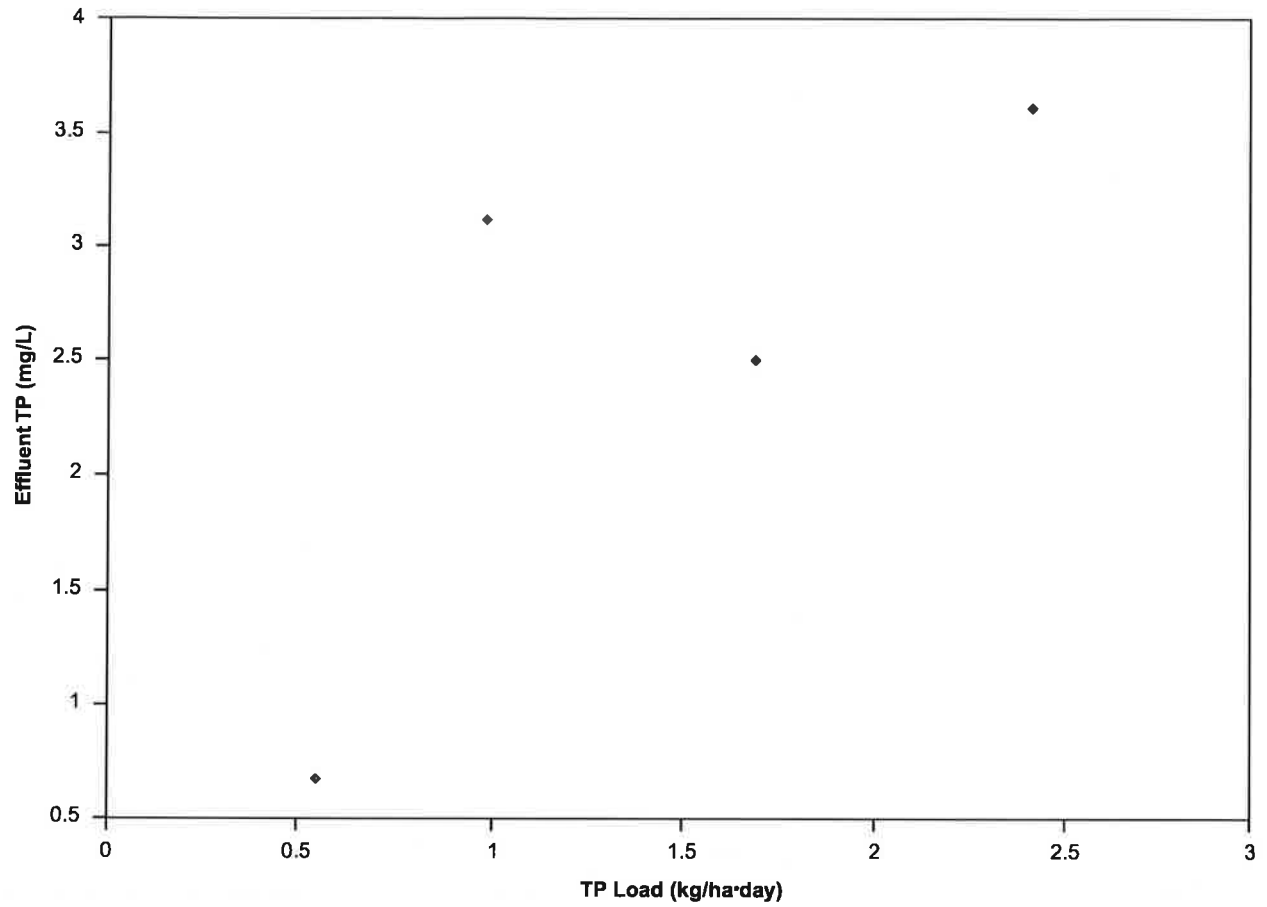


Figure 4-6. Effluent TP vs. TP areal loading

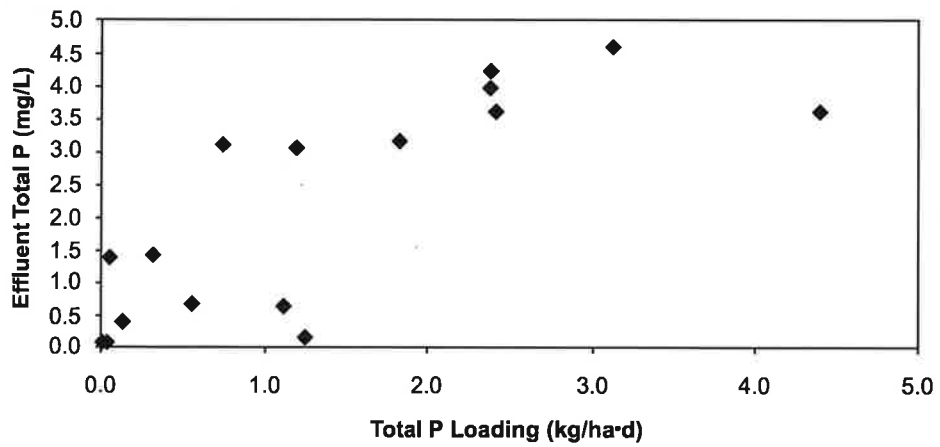


Figure 4-7. Average total phosphorus loading rate vs. total phosphorus effluent concentration for TADB wetland systems

phorus removal. An upper limit of 1.5 mg/L removal of orthophosphates was found at loadings of less than 1.5 kg/ha-d and a hydraulic retention time (HRT) of at least 15 days. HRTs of less than 7 days yielded a maximum removal of 0.7 mg/L of orthophosphate, as shown in Figure 4-8.

The phosphorus cycle of uptake during the growing season and release during senescence and the initial substantial uptake of phosphorus by the soil of the FWS further confounds short-time studies of phosphorus transformations and removal. As a final issue in this conundrum, the particulate fractionation and chemical speciation of the influent phosphorus will also have some impact on transformations and fate of P. Therefore, long-term studies which differentiate between P forms and document vegetation condition, climate, temperature and other pertinent water quality parameters are necessary to provide meaningful information for future FWS system designers, but the annual P removal by these systems is quite limited based on mechanistic evaluations and controlled studies.

4.1.7 Fecal Coliform Performance

Only four systems in the DMDB reported fecal coliform (FC) data, and three of those were fully vegetated systems. The average removal was just over 2 logs, from 72,700/100mL to 400/100ml. The TADB (EPA, 1999) results are shown in Figure 4-9 which offers no obvious relationship between inlet and outlet concentrations. Figure 4-10 (Gearheart, 1989) shows results from the Arcata pilot study which demonstrate that flocculation/sedimentation is the primary FC removal mechanism for fully vegetated cells or zones. This figure is especially valuable in light of the world literature on FC dieoff in lagoons which identify solar radiation as the primary disinfection mechanism (Mara, 1975). Such a mechanism can be effective in open-water zones of the FWS, but the same mechanisms which remove settleable and colloidal solids in fully vegetated zones are responsible for FC removal in those zones.

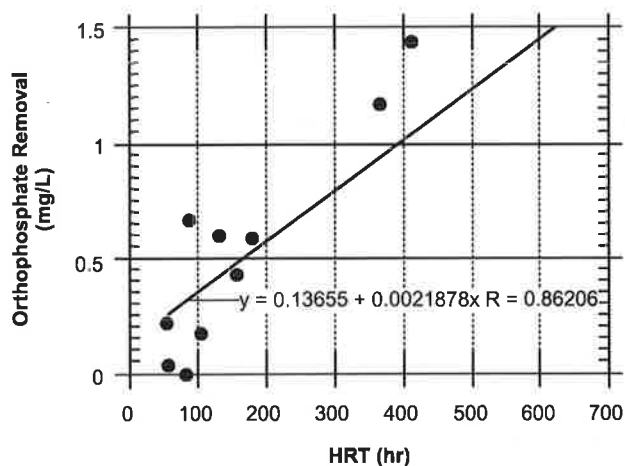


Figure 4-8. Retention Time vs. Orthophosphate Removal (mg/l)

Estimates of the internal addition of background fecal coliform by wildlife in treatment wetlands are provided by those systems that receive disinfected influent. For example, the Arcata Enhancement Wetland received chlorinated effluent, and during the period 1990-1997 (Gearheart, et al, 1998), the effluent FC was less than 500 MPN/100mL about 80% of the time. This is a system with large open-water zones that supports a wide variety and high population of aquatic birds and mammals. Higher levels of background FC levels are found during the fall and winter bird migration period. A similar study on the same system during 1995-1996 showed that the effluent mean was 40 CFU/100mL, was less than 300 CFU/100mL over 90 percent of the time, and on no occasion exceeded 500 CFU/100mL. Studies of MS-2 coliphage showed similar (2 logs) removal to that which was obtained with FC (Gearheart, 1995).

The considerable temporal variability in the effluent microorganism counts produced by treatment wetlands and conventional treatment technologies suggests the use of geometric averaging to determine monthly mean values from daily or weekly measurements. Even with geometric means, individual monthly values are frequently 10 times larger or smaller than the long-term mean for many treatment wetlands, possibly due to wildlife habitat features. This implies that at sites which have strict FC restrictions, the ability to disinfect the FWS effluent is required.

4.1.8 Metals & Other Particulate-Oriented Pollutants

While some metals are required for plant and animal growth in trace quantities (barium, boron, chromium, cobalt, copper, iodine, iron, magnesium, manganese, molybdenum, nickel, selenium, sulfur, and zinc), these same metals may be toxic at higher concentrations. Other metals may be toxic at even very low concentrations (e.g. arsenic, cadmium, lead, mercury, and silver) (Gearheart, 1993).

Information from FWS treatment wetlands indicates that a fraction of the incoming metal load will be trapped and effectively removed through sequestration with settleable suspended solids and soils. For many metals, the limited data indicate that concentration reduction efficiency and mass reduction efficiency correlate with TSS reduction. Wetland background metal concentrations and internal profiles are not well known. It has been shown that chromium levels higher than 0.1 mg/L and copper levels higher than 1.0 mg/L have detrimental effects on a floating duckweed species (*Lemna gibba*). Table 4-2 shows metal concentration data obtained from a constructed wetland demonstration project in Sacramento, where disinfected activated sludge effluent was applied to parallel 1.44 acre cells, each with a hydraulic loading of 65 m³/ha-d and similar plant density.

The valence and form of each metal was not determined, but nickel and arsenic appeared to be the most resistant to removal (SCRSD, 1998). Several researchers have stud-

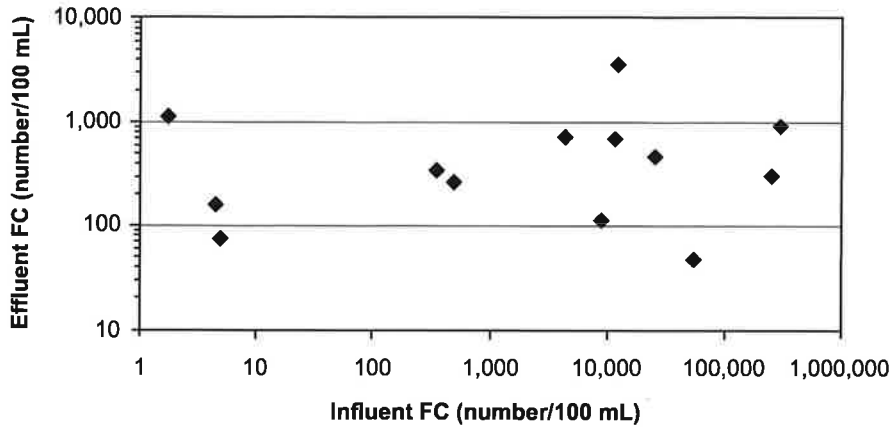


Figure 4-9. Average influent FC concentration vs. FC effluent concentration for TADB wetland systems

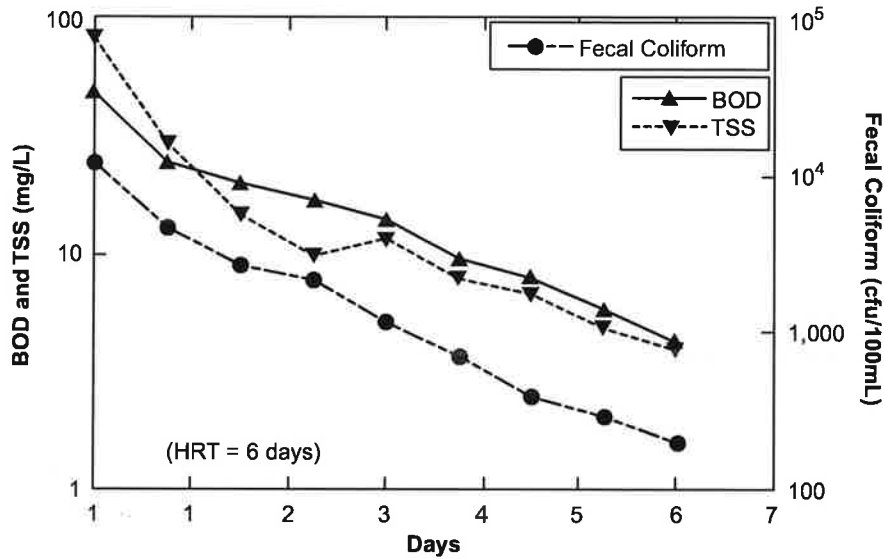


Figure 4-10. Arcata pilot Cell 8, TSS, BOD, FC

Table 4-2. Trace Metal Concentrations and Removal Rates, Sacramento Regional Wastewater Treatment Plant (SCRSD, 1998).

Metal	Influent (mg/L)			Effluent (mg/L)			Removal (%) Rate
	Min	Mean	Max	Min	Mean	Max	
Silver	0.25	0.29	0.32	0.02	0.03	0.03	90
Arsenic	2.00	2.23	2.60	1.50	2.20	3.10	1.3
Cadmium	0.040	0.077	0.140	0.005	0.009	0.019	88
Chromium	0.50	1.05	1.40	0.50	0.77	3.10	27
Copper	4.60	8.62	17.00	1.60	4.04	7.00	19
Mercury	0.0084	0.0105	0.0144	0.0021	0.0031	0.0041	71
Nickel	4.30	8.23	23.00	4.10	8.96	20.00	—
Lead	0.25	0.58	1.20	0.05	0.14	0.26	55
Antimony	0.40	0.41	0.42	0.12	0.15	0.20	63
Selenium	0.50	0.50	0.50	0.50	0.50	0.50	—
Zinc	6.4	26.2	34.0	1.30	3.53	8.70	70

water infiltration (I) and berm losses (Q_b) can be neglected if the wetland is lined with an impermeable barrier, and the snowmelt (Q_{sm}) is only important in certain locations.

4.2.2 Wastewater Inflow

The daily wastewater inflow flow rate (Q_o) will almost always be the primary inflow into a FWS constructed wetland. If the FWS wetland is being added to an existing wastewater treatment process, wastewater flow rates may already be measured. If the wastewater flow rates and variability are not known, they can be estimated using conventional engineering methods. Examples of variable wastewater flows include seasonal peaks from vacation communities and seasonal high infiltration and inflow rates into collection systems.

4.2.3 Precipitation, Snowmelt, and Catchment Runoff

Depending on the time period of the water balance, daily, monthly or seasonal precipitation and snowmelt data may be required. Precipitation inflows into a wetland come from direct precipitation (P) onto the wetland surface area and runoff from the wetland catchment (Q_c). Snowmelt (Q_{sm}) accounts for the amount of water entering the wetland from melting snow from the wetland catchment. The effects of precipitation on the wetland water balance are normally significant, while snowmelt can be seasonably significant only in certain climates. Q_c is a significant factor only in the rarest of circumstances.

4.2.4 Wastewater Outflow

The wastewater outflow (Q_o) corresponds to the amount of treated wastewater leaving the FWS constructed wetland over a specified time period. Wastewater outflow reflects the balance between inflows, additional water gains and losses, and the change in storage of the FWS constructed wetland.

4.2.5 Evapotranspiration

Wetland evapotranspiration (ET) is the combined water loss due to evaporation from the water surface and transpiration from wetland vegetation. The loss of water from ET affects the wetland in two ways. It increases the hydraulic retention time by removing water, and can concentrate certain pollutants, especially conservative dissolved constituents. For non-conservative constituents, such as BOD, an increase in the hydraulic retention time may provide a modified removal rate which can either partially offset or enhance the concentrating effects of ET.

Specific ET rates have proven difficult to accurately measure in FWS wetlands. As a consequence, it is common practice in wetland design to assume that wetland ET rates are equivalent to some percentage of open water or pan evaporation rates. Kadlec and Knight (1996) recommend that ET be assumed equal to 70 to 80% of Class A pan evaporation in fully vegetated FWS systems. Reed, et al, (1995) suggest 80% of the pan rate. Since ET rates

in FWS systems may vary from those in open waters to those in fully vegetated zones, an overall average rate may be useful. A rate of 70 to 75% of the pan rate is a reasonable assumption since the two are not significantly different. Maximum ET rates have been found in smaller wetlands or wetland test cells with small area to perimeter ratios (Gearheart, et al, 1993). ET rates of up to 5 mm/d are found in the southern U.S., and Q_e may approach zero during these periods (EPA, 1999).

4.2.6 Infiltration and Berm Losses

Infiltration (I) is the loss of water that occurs into the bottom soils or berms of a FWS constructed wetland. If present, infiltration decreases the outlet flow rate, effectively increasing the water retention time and increasing the potential for constituent removal. Constituent reduction may be further improved by the loss of soluble pollutants into the soil as the water infiltrates. Infiltration tends to reduce with time as clogging of soil pores progresses (Middlebrooks, et al, 1982). If the FWS constructed wetland is lined with some type of impermeable barrier, infiltration can be neglected in the water balance. If not, siting on more permeable soils might endanger ground water quality.

4.2.7 Wetland Volume

The outlet in a FWS constructed wetland generally consists of a control structure that can regulate water depths in the wetland. Increasing or decreasing water levels changes the wetland volume, which influences the water balance by providing more or less storage capacity. The wetland volume (V_w) or storage capacity directly influences the time required for the wastewater to pass through the wetland. Water storage capacity can be increased to offset the effects of high seasonal precipitation or evapotranspiration. Since FWS constructed wetlands have a continuous wastewater inflow and some form of outlet water level control, water surface elevations do not change significantly, unless the wetland operation and maintenance schedule dictates water level fluctuations. The type of emergent aquatic plants in each region of an FWS is primarily determined by the depth of the FWS in that zone. For the most part 1.2m (4 feet) is considered the maximum seasonal water depth for fully vegetated sections of the wetland. Normal operating depths vary from 0.5 to 0.75m (1.7 to 2.5 feet) depending on the types of plants and types of physical substrate.

4.3 Wetland Hydraulics

From a design perspective, wetland hydraulics defines the movement of water through a FWS constructed wetland. A FWS constructed wetland with poor hydraulic design can be problematic in terms of effluent water quality, odors, and vector nuisances. This section first defines some basic wetland hydraulics terms, and then briefly summarizes basic wetland hydraulic principles.

where q has units of L/T . Generally the hydraulic loading rate is determined using the wastewater inflow (Q_0).

4.3.2 Water Conveyance

Water conveyance in FWS wetlands is hydraulically complex, varying in both space and time due to wetland vegetation and litter, changing inflow conditions, and the stochastic nature of hydrologic events.

When designing a constructed wetland, it is necessary to understand how water moves through the wetland, and how this water movement influences various design considerations.

4.3.2.1 Ideal versus Actual Flow in a FWS Constructed Wetland

Though plug flow is generally assumed for the purposes of FWS constructed wetland design, actual wetland flow hydraulics do not follow an ideal plug flow model. The deviation from plug flow of an existing FWS constructed wetland can be determined through the use of tracer tests. One result of a tracer test is the determination of the average tracer retention time, which is defined as the centroid of the response curve, as shown in Figure 4-11. The average tracer retention time is equal to the active water volume (V_w) (ϵ) divided by the average volumetric flow rate (Q_{avg}), and thus represents a direct measure of actual retention time. Results from some tracer studies have shown that the hydraulic characteristics of a FWS constructed wetland can be approximated by a series of 4 to 6 equally

sized complete mix reactors (Kadlec and Knight, 1996; and Crites and Tchobanoglous, 1998). In other studies, the complete mix reactor model has resulted in a poor fit to the data, and other models have been more successful. Figure 4-11 shows the observed tracer concentration from one wetland cell of the Sacramento Regional Wastewater Treatment Plant Demonstration Wetlands Project compared to the predicted tracer concentrations using the finite state model first suggested by Hovorka (1961). The finite stage model integrates components of completely mixed, plug flow, and off line storage addition/feedback into one hydraulic model. Coefficients are unique for each geometry, planting pattern, etc. For any given site with appropriate data the finite stage model gives the best fit of the tracer data. This method was first applied to FWS systems at the Arcata pilot studies (Gearheart, et al, 1983) and has subsequently been applied to the Sacramento system (Dombeck, 1998). The value of multiple cells and periodic open-water zones have been recognized for minimizing short-circuiting by numerous authors.

4.3.2.2 Hydraulic Gradient in a FWS Constructed Wetland

For FWS constructed wetlands, some assessment of the energy loss or head loss from inlet to outlet is necessary to ensure that the wetland is designed to handle all potential flows without creating significant backwater problems, such as flooding the inlet structures or overtopping berms. It has historically been assumed that Manning's equation, which defines flow in open channels, can be adapted to

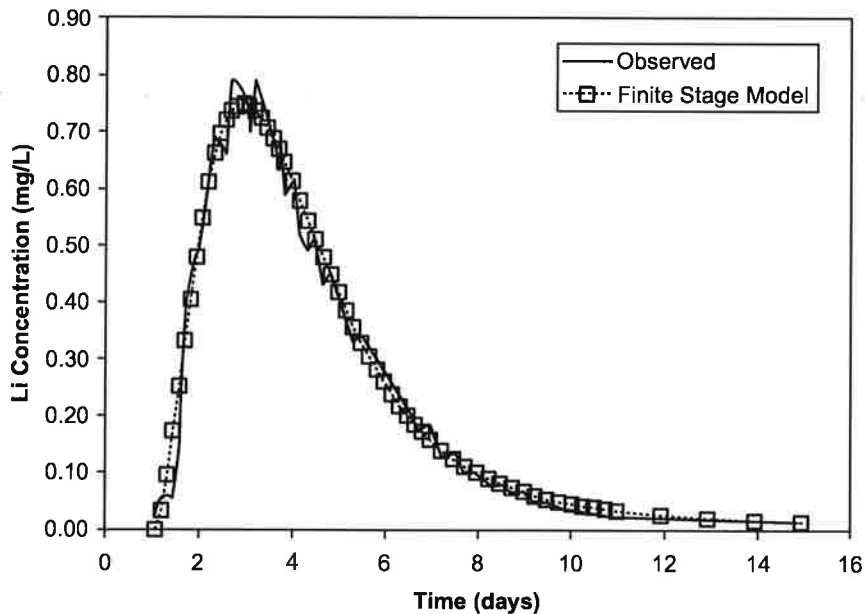


Figure 4-11. Tracer response curve for Sacramento Regional Wastewater Treatment Plant Demonstration Wetlands Project Cell 7 (SERSD, 1998).

estimate head loss in FWS wetlands. By assuming that the submerged wetland vegetation, peat and litter provides more frictional resistance to flow than the wetland bottom and sides, Manning's equation has been adapted as follows:

$$S^{1/2} = \frac{v}{(1/n)(h^{2/3})} \quad (4-6)$$

where:

- v = average flow velocity (L/T),
- n = Manning's resistance coefficient (T/L^{1/3}),
- h = average wetland depth (L), and
- S = hydraulic gradient or slope of water surface (L/L).

In the above equation, the average wetland depth and water surface slope is fairly easily estimated, and the average velocity (v) is defined as the average flow (Q_{avg}) divided by the available average cross sectional area (A_v)(ϵ), or (Width)(depth)(ϵ). The determination of Manning's resistance coefficient (n) is not as straightforward. In wetlands, the vegetation and litter providing resistance to water flow is distributed throughout the water column, with settled particles and detritus on the bottom and a thicker thatch level at the top. Thus, n should be a function of the water depth as well as the resistance of specific surfaces. Measurements of n in operating wetlands range from approximately 0.3 to 1.1 s/m^{1/3} with the higher numbers corresponding to water depths less than 0.2 m (Kadlec and Knight, 1996). Reed, et al, (1995) use an equation to estimate n at 0.2m depth to vary from 1 to 14 s/m^{1/3}. Linsley, et.al., (1982) offer a series of values for n from 0.024 to 0.112. A default value of 0.1 to 0.5 is suggested for those wishing to pursue this issue. A typical solution provided in Crites and Tchobanoglous (1996) is a slope of 1 in 10,000, or 1cm in 100 meters. Since multiple cells are recommended as good design practice to minimize short-circuiting and to maximize treatment performance, the above analysis is superfluous for most applications where aspect ratios (length/width) are within suggested limits of 3:1 to 5:1, or even larger.

4.4 Wetland System Design and Sizing Rationale

4.4.1 Introduction

As FWS constructed wetlands became recognized as a viable wastewater treatment process, FWS design models soon followed. These models were intended to aid engineers/designers in the process of FWS wetland design and performance assessment. To date, a number of wetland design methods have been proposed for predicting constituent removals in FWS wetlands. These may be found with explanation in Reed, et al, (1995), Kadlec and Knight, (1996) and Crites and Tchobanoglous, (1998). The design models and methods have been used to attempt to predict the fate of BOD, TSS, TN, NH₄⁺, NO₃⁻, TP and fecal coliforms in a FWS system.

Free water surface constructed wetlands have usually been modeled as attached growth biological reactors, in

which the plants and detrital material uniformly occupy the entire volume of the wetland.

The current trend in wetland design modeling is the development of simple mass balance or input/output models. These simplified models do not explicitly account for the many complex reactions that occur in a wetland, either in the water column or at interfaces such as the water/sediment interface. Instead, all reactions are lumped into one overall biological reaction rate parameter that can be estimated from collected FWS wetland performance data. At this stage of wetland understanding, more complex and theoretical wetland models which explicitly describe the kinetics of known wetland processes may not be possible due to severe limitations in almost all of the existing wetlands data.

4.4.2 Existing Models

In essence the types of models that have been used in FWS constructed wetland design are known as plug-flow-reactor (PFR) models. One assumes horizontally based (linear) kinetics (Reed, et al, 1995; Crites and Tchobanoglous, 1998), while the other assumes vertical (areal) kinetics (Kadlec and Knight, 1996). Several varieties of these models exist. Some assume average kinetic rate constants, while others assume retarded kinetic rate constants. All provide a list of effluent background concentrations below which an FWS cannot dependably attain and specific default values for temperature adjustments to correct kinetic rate constants. Some suggest monthly multipliers for average computed design performance. Some include safety factors within the equation while others apply them to the model result. All assume first-order biological kinetics, despite the fact that the initial fully vegetated treatment zone is anaerobic, and none of these models can account for a sequencing, i.e., fully vegetated and open-water zones in sequence, design which is recommended herein for better performance. Recently, one of the primary model creators has also noted the inadequacy of these models (Kadlec, 2000). Readers are referred to Kadlec and Knight (1996), Reed, et al, (1995), and Crites and Tchobanoglous (1998) for details. For the purpose of this manual, i.e., providing secondary (BOD=SS =30mg/l) and advanced secondary treatment of municipal wastewaters, none of these equations alone are able to accurately predict the performance of a multi-zone FWS constructed wetland. Even if they could be calibrated "to fit" a specific set of data their non-deterministic basis belies their ability to fit other circumstances of operation.

4.4.3 Areal Loading Rates

The areal loading rate method specifies a maximum loading rate per unit area for a given constituent. These methods are common in the design of oxidation ponds and land treatment systems. Areal loading rates can be used to give both planning level and final design sizing estimates for FWS systems from projected pollutant mass loads. For example, knowing the areal BOD loading rate, the expected BOD effluent concentration can be estimated or compared to the long term average performance data of other well-documented, full-scale operating systems.

In section 4.1 each pollutant was discussed based on areal loading vs. effluent concentration based on the DMDB, the TADB, specific studies and mechanistic evaluations of other sources of information. Areal loading does not always correlate to a reasonable design basis, especially with regard to nutrients and pathogen removal, and other mechanistic explanations are necessary. However, if typical municipal wastewaters are to be treated which have total and filtered pollutant fractionation which are reasonably consistent from site to site, a rational design approach can be deduced for those parameters which can be removed during the enhanced flocculation/sedimentation which occurs in the initial fully vegetated zone of a FWS constructed wetland. Therefore, based on Figures 4-1 and 4-4 the following areal loadings can be employed for this initial zone (zone 1) of the FWS :

Parameter	Zone 1 Areal Loading	Effluent Concentration
BOD	40 kg/ha-d	30 mg/L
TSS	30 kg/ha-d	30 mg/L

The relative areal loadings imply that unless the pretreatment process were to have a BOD concentration of greater than 1.3 times the TSS concentration, the latter would be the critical loading rate for the fully vegetated zone if secondary standards are to be met by a fully vegetated FWS system.

If the FWS system were to have significant open areas between fully vegetated zones, a better effluent quality could be attained at areal loadings, based on the entire FWS system area (A_w):

Parameter	Areal Loading	Effluent Concentration
BOD	45 kg/ha-d	<20 mg/L
	60 kg/ha-d	30 mg/L
TSS	30 kg/ha-d	< 20 mg/L
	50 kg/ha-d	30 mg/L

These loadings are based on the entire system area, not just zone 1. Therefore, with open-water zones which provide aerobic transformations and removal opportunities, a better effluent quality is achievable than with a fully vegetated FWS system. Although there are insufficient data at this time to eliminate the need to provide effluent disinfection, more disinfection interferences are removed which would facilitate that step. Conversely, the open water zones would attract wildlife to a greater degree, and the impacts created by their activities. Similarly, the need to and the power required to reaerate the final effluent will at the least be reduced. The advantages of this design concept have been described by Gearheart and Finney (1996) to include reduced "background" BOD concentrations in the effluent owing to the aerobic biological removals in the open-water zones. As with the fully vegetated systems, the TSS areal loading is more critical. With more quality data these limiting loadings could be shown to be conservative, especially the BOD loading for attaining secondary effluent standards with open-water FWS systems.

4.5 Design

4.5.1 Design Sizing and Performance Mechanisms

If a pretreatment system already exists, the type of influent characterization necessary has already been discussed, but at a minimum all pollutants which are of concern to the NPDES permitting authority should be measured as both total and filtered through a standardized glass fiber filter prior to analysis. Ideally, a particle-size distribution analysis of the type described in Crites and Tchobanoglous (1998) could be performed for all critical pollutants to aid the designer in predicting what level of removals of each pollutant are likely to be attained by an FWS or other treatment processes. If the pretreatment system does not exist, the designer will need to perform a variety of investigations as described in several engineering texts (e.g., Crites and Tchobanoglous, 1998; WEF, 1998).

A primary supposition of this manual is that a FWS constructed wetland is most likely to treat effluent from a stabilization or oxidation pond or from primary-treated (settled) municipal wastewater. After the designer determines overall size of the FWS system from these BOD and TSS areal loading rates, he or she can return to evaluate the fate of other constituents.

If the total and filtered analyses are available, it is a reasonable approximation to assume that the filtered analysis represents a rough approximation of effluent quality attainable from treatment zone 1 (fully vegetated zone) given that the filter pores are generally a bit larger than the specific particle sizes indicated for the "colloidal/soluble" fraction in Table 4-3. Internal loads in the soluble form should also be added to this fraction in estimation of zone 1 effluent (see Figure 4-2 and 4-3). For more stringent effluent requirements than those cited above for BOD and TSS, the designer should look at alternative polishing processes such as land treatment or slow sand filtration.

While a few physical and chemical processes occur uniformly over the entire wetland volume, many of the most important treatment processes occur in a sequential manner and the wetland must be designed to accommodate this characteristic. For example, TSS removal and removal of associated BOD, Org N and P, metals, etc., occur in the initial portion of the cell, while the subsequent zones can impact certain soluble constituents. Given sufficient dissolved oxygen in open (unvegetated) areas, soluble BOD removal and nitrification of ammonia can occur. If insufficient oxygen is present, soluble BOD is very slowly removed by anaerobic processes. Wetland design must also consider the background level, or expected lower limit, of water quality constituents in the FWS wetland effluent (see Table 4-4). Particulate and soluble constituents are internally produced as a part of the normal decomposition and treatment processes occurring in a constructed wetland. Wildlife contribute fecal coliform and additional organic compounds. During periods of intense activity, wildlife also

stir up settled solids contributing to an increase in turbidity, TSS, and BOD. Table 4-4 shows the typical background levels for the constituents of interest recommended for users of this document. Designs requiring effluent quality close to the values in Table 4-4 must be aware of the natural fluctuations about the mean values, as shown in Figure 4-12. For more details on the numerical values in the table, the reader is urged to refer to Reed, et al, (1995), Kadlec and Knight, 1996, and Gearheart, 1992.

A similar approach to the one suggested here for designing FWS wetlands, referred to as the "sequential model", has been developed by Gearheart and Finney (1999). The overall approach of the model is to consider the dominant physical and biological processes responsible for determining effluent quality from each distinctive area or zone of the constructed wetland and allow the designer to specify areal requirements and wetland depth for each of these specific functions. This methodology recognizes that while some of the constituent transformations and removal mechanisms are to some degree occurring simultaneously throughout the wetland, the majority of the removal occurs in a sequential fashion, with one process or mechanism providing the products for the next process or mechanism. The total area required for treatment is then a sum of each of the zones required to reach a specific effluent objective. This approach allows the designer to sequentially determine the range of effluent characteristics which are attainable in a given definable zone before entering a subsequent reactor (zone) which has known treatment capabilities.

Table 4-4. Background Concentrations of Water Quality Constituents of Concern in FWS Constructed Wetlands

Parameter	Range (mg/L)	Typical (mg/L)	Factors governing
TSS	2 - 5	3	Plant types, plant coverage, climate, wildlife activity
BOD ¹	2 - 8	5	Plant types, plant coverage, plant density, climate, wildlife activity
BOD ²	5 - 12	10	Plant types, plant coverage, plant density, climate
TN	1 - 3	2	Plant types, plant coverage, climate, oxic/anoxic conditions
NH ₄ -N	0.2 - 1.5	1	Plant types, plant coverage, climate, oxic/anoxic conditions
TP soil	0.1 - 0.5	0.3	Plant types, plant coverage, climate, type
FC ³	50 - 5000	200	Plant types, plant coverage, climate, wildlife activity

¹FWS with open water and submergent and floating aquatic macrophytes.

²Fully vegetated with emergent macrophytes and with a minimum of open water.

³Measured in cfu/100 ml

The sequential model approach recognizes that all the treatment objectives beyond secondary require a minimum of three general wetland "compartments" (see Figure 4-13): (1) an initial compartment where the bulk of the flocculation and sedimentation will occur, (2) an aerobic compartment where soluble BOD reduction and nitrification can occur, and (3) a vegetated polishing compartment where further reductions in TSS and associated constituents and nitrogen (via denitrification) can occur. Permanent phosphorus removal in wetlands is generally small and is largely the result of phosphorus adsorption to solids and plant detritus. Sedimentation and pathogen reduction are related to detention time in zone 1, to retention time and temperature in zone 2, and to retention time in zone 3. As noted earlier, the notion of "compartments" is artificial as the treatment processes overlap in time and space, and no specific physical compartment is necessarily implied. However, separation of an FWS into a series of single-function zones (cells) with individual outlet controls is not an unattractive concept.

A rational overview of the FWS system is depicted in Figure 4-14. It illustrates that the primary mechanisms in zone 1, which is fully vegetated and anaerobic throughout its depth during the growing season, are sedimentation and flocculation, as determined by transect measurements of dissolved oxygen and pollutant concentrations. Any extension of the HRT in zone 1 beyond approximately 2 days at Q_{max} would be essentially wasteful since the anaerobic conditions will not result in any significant further removal of soluble constituents and flocculation sedimentation has been effectively completed. The TSS and associated constituents (particulate BOD, organic nitrogen and phosphorous, metals and certain semivolatiles organic compounds) have also reached this same status. Volatile organics are likely to be removed from the wastewater during the collection or oxidation pond treatment processes (Hannah, et al, 1986), while most semivolatiles are removed with the solids in the oxidation pond or in zone 1 of the FWS system.

For many years it has been recognized that effluent flocculation is primarily a function of energy input from either external sources or internal hydrodynamic forces, and that reduced Reynolds' Numbers (Re) induce optimal sedimentation of particles. Over the past several decades this phenomena has been applied in the development of hydrodynamic devices which accomplish excellent flocculation and/or sedimentation without moving parts, such as pipe mixers and flocculators, tube and plate settlers, and pebble bed and wedgewire outlet devices for clarifiers. Flow through the emerging vegetation is extremely tortuous and is accompanied by a very small hydraulic radius. The Reynolds Number (Re) is a direct function of the hydraulic radius (diameter, if the path were round (as in a pipe)). If the Re falls in a range which corresponds to laminar flow, sedimentation is maximized. Re is several thousand in large basins, and even larger in non-vegetated ponds. No direct measurements of Re or laminar flow have been made at the time of this writing, but analogous results from studies

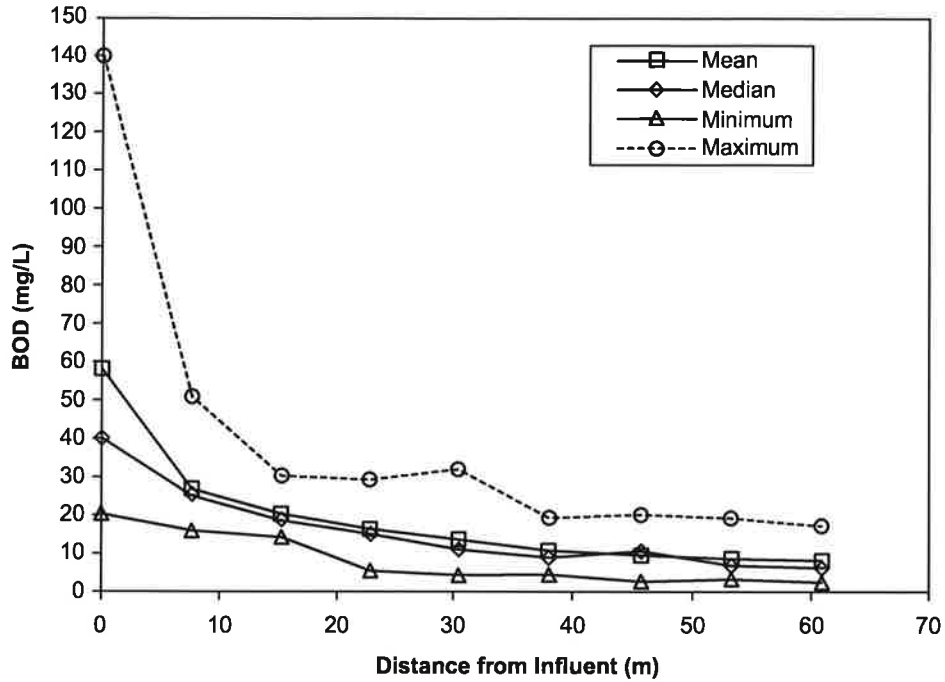


Figure 4-12. Mean, median, minimum and maximum transect BOD₅ data for Arcata Pilot Cell 8

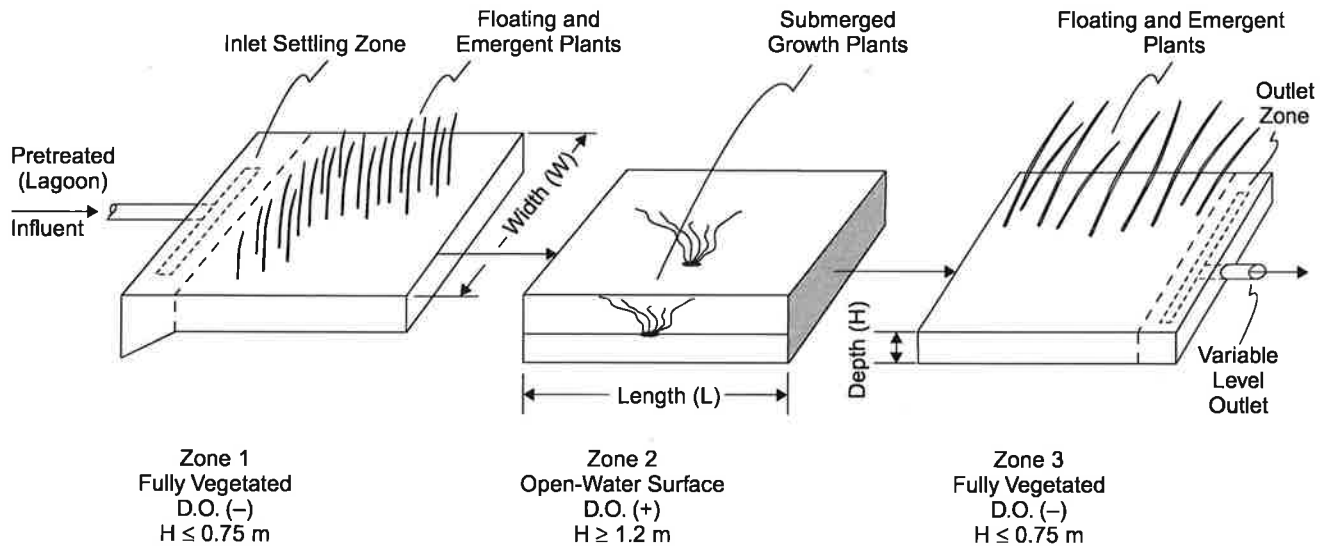


Figure 4-13. Elements of a free water surface (FWS) constructed wetland

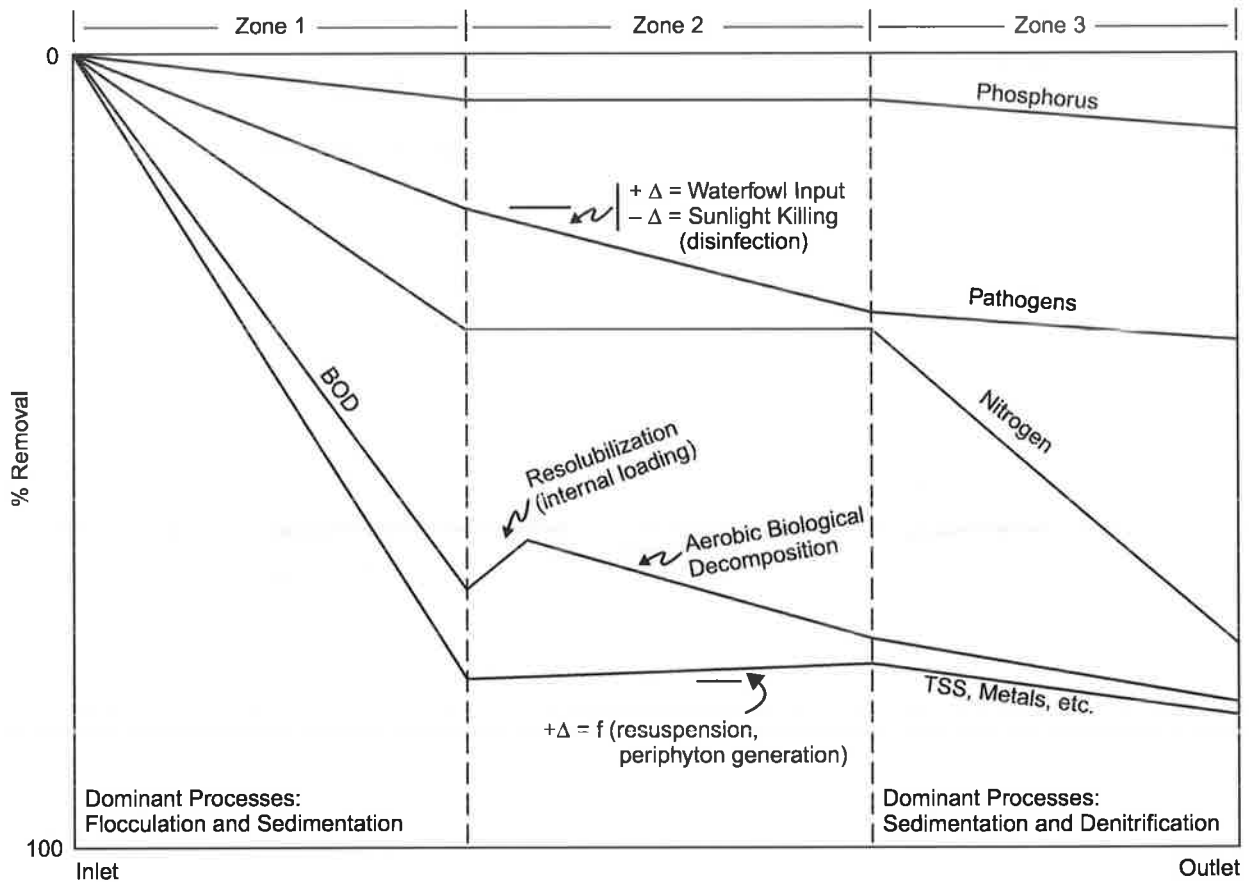


Figure 4-14. Generic removal of pollutants in 3-zone FWS system

of tube settlers and particle-size removals support this theory, given the large amount of wetted surface available. (Sparham, 1970). This concept also supports the use of fully vegetated areas immediately preceding outlet weirs.

In zone 2, which is primarily open-water, the natural reaeration processes are supplemented by submerged macrophytes during daylight periods to elevate dissolved oxygen in order to oxidize carbonaceous compounds (BOD) to sufficiently low levels to facilitate nitrification of the $\text{NH}_4\text{-N}$ to $\text{NO}_3\text{-N}$. These processes require large amounts of oxygen and time in a passive system (no mechanical assistance). The maximum HRT in zone 2 is generally limited to about 2 to 3 days before unwanted algal blooms occur. Therefore, more than one open zone may be required to complete these reactions. If so, the result would be a five (or more) zone design since each open zone would be followed by a fully vegetated zone. The reactions in zone 2 are essentially the same as in a facultative lagoon. Therefore, the equations which apply to those systems might offer reasonable approximations to the rate of transformations occurring in this open-water zone. Therefore, the first-order Marais and Shaw (1961) equation for

fecal coliform dieoff could be applied as an approximation, along with its temperature dependency:

$$\frac{C_e}{C_o} = \frac{1}{(1 + tK_p)^N} \quad (4-7)$$

where: C_o = influent FC concentration, cfu/100 ml
 C_e = effluent FC concentration, cfu/100 ml
 N = number of open-water zones in the FWS
 t = HRT (T)
 K_p = fecal coliform removal rate constant (T^{-1})
 $= 2.6 (1.19)^{T-20}$ (4-8)

where: T = temperature, °C

BOD removal in the open-water zone should also follow existing equations such as (Crites and Tchobanoglous, 1998);

$$\frac{C_e}{C_o} = \frac{1}{(1 + tK_p)^N} \quad (4-9)$$

where:

$$C = \text{BOD, mg/L}$$

K_b = specific BODs removal rate constant
(T^{-1})

$$K_b = 0.15 (1.04)^{T-20} \quad (4-10)$$

Therefore, in analyzing Figure 4-14 the downward slope in FC and BOD in zone 2 can be approximated through the above equations, without considering offsets from wildlife. As noted previously, the nitrifying bacteria can proliferate and convert ammonia-nitrogen to nitrate ($\text{NO}_3\text{-N}$) and will be the primary nitrogen transformation role of zone 2. However, the carbonaceous BOD must be low enough to allow these reactions to occur. In rotating biological contactors this concentration of BOD is about 15 mg/l (USEPA, 1993). As noted by Gearheart (1992) increasing the size of the open-water zone generally increases dissolved oxygen, pH, and $\text{NO}_3\text{-N}$, while decreasing soluble BOD and ammonium.

U.K.'s Department of Environment has studied lagoon systems treating similar quality influent to that of zone 2. They have noted that algal growth generally starts to occur between days 2 and 3 (UK, 1973). Algal growth can raise pH, interfere with FC kill and the growth of submerged plants, increase $\text{NH}_3\text{-N}$ volatilization, and induce phosphorus precipitation. Also, the additional biomass and precipitates that must be removed in zone 3 will add to the internal loading on the FWS system. The primary goal of the open-water zone is to provide dissolved oxygen to remove BOD and convert $\text{NH}_4\text{-N}$ to $\text{NO}_3\text{-N}$. Therefore, the optimum sizing of this zone would be an HRT of 2 to 3 days. Assuming a $Q_{\text{max}}/Q_{\text{ave}}$ of 2, the designer might choose an HRT of 2 days at Q_{max} or an HRT of 3 days at Q_{ave} . Climate would likely be the final criterion, with the larger size favored in northern areas and the smaller in southern ones.

The third zone is fully vegetated like zone 1 and has a similar function. Zone 3, like zone 1 is also capable of denitrification if the influent flow contains $\text{NO}_3\text{-N}$. Where oxidation pond pretreatment of municipal wastewaters is employed, zone 1 of the FWS system is not generally required to denitrify, but zone 3 will if zone 2 induces nitrification. The primary energy source for successful denitrification is the release of organic substrates from the detritus from decaying plants. However, partially digested, previously removed organics may also be available. Denitrifying bacteria perform only under anaerobic conditions and best when attached to large surface areas, e.g., plants. Denitrification, like nitrification, is temperature-sensitive. Nitrification and denitrification are greatly impaired when water temperatures are reduced below 10°C . Gearheart (1992) showed total inorganic nitrogen in the Arcata Marsh to be reduced from 25 to 5 mg/L. In 1995 he demonstrated pilot-scale removal of $\text{NO}_3\text{-N}$ from 130 mg/L to 6 mg/L using no supplemental carbon sources in 80 hours at 15°C . The primary limitation in a three-zone FWS system designed

to remove nitrogen is the rate of nitrification in the open-water zone. If the open-water zone succeeds in nitrifying the $\text{NH}_3\text{-N}$, the system should be able to denitrify it. Reed, et al, (1995) indicate that denitrification should require less than one day hydraulic retention time (HRT) for denitrification from municipal wastewater concentrations to an effluent requirement of ≤ 10 mg/L. Kadlec and Knight (1996) found that 1 to 2 days should suffice to reach 90% $\text{NO}_3\text{-N}$ removal. Therefore the previously- stated requirement for zone 3 (HRT of 2 days) should meet this retention requirement and ensure significant denitrification. WEF Manual of Practice FD-16 (1990) indicates that the denitrification rate can be as high as 10 kg/ha-d. Loadings must be within the limits of available labile carbon to proceed at the maximum rate.

As with zone 1 there is additional, temporary nutrient (N and P) removal by plant uptake in zone 3, which may be significant at certain times during the year, while release of most of these nutrients occurs at other times. These plant effects can mask the effects of other processes which could be impacting the system performance at the same times. Unfortunately, there are insufficient data to fully quantify the nutrient cycle for each zone of the FWS system.

4.5.2 Total Suspended Solids Removal Design Considerations

Since prior discussion indicates that TSS removal (rather than BOD removal) drives the sizing process, there is a need to provide further discussion of the mechanisms involved and their implications on design. Treatment mechanisms which dominate in the vegetated inlet zone of a FWS constructed wetland volume are flocculation, sedimentation and anaerobic decomposition. Discrete and flocculent settling occurs as the wastewater flows through the initial fully vegetated zone. Since the FWS was likely preceded by an oxidation pond where most discrete settling has occurred already, the enhanced settling in zone 1 is mostly due to flocculation of large supracolloidal solids in passage through the emergent vegetation. The processes are generally not temperature dependent and occur at relatively high hydraulic loading rates. TSS removal rates of 40 to 60% are common with a q of 0.06 m/day to 0.27 m/day, but relative removals are more accurately determined by influent characteristics and the hydrodynamics of the initial vegetated zone.

The majority of incoming solids are removed in this initial settling volume. Hyacinth and duckweed systems are similar to (but not as good as) zone 1 of an FWS in the hydrodynamics which promote excellent flocculation and sedimentation. The mechanisms of the fully vegetated zone 1 can be estimated from the use of particle size distribution analysis. Generally, wastewaters have been analyzed in form size ranges:

- Settleable ($>100 \mu\text{m}$)
- Supracolloidal (1 to $100 \mu\text{m}$)
- Colloidal (0.001 to $1 \mu\text{m}$)
- Dissolved ($< 0.001 \mu\text{m}$)

Only one study has employed this approach (Gearheart and Finney, 1996) with oxidation ponds followed by FWS constructed wetland treatment. The results shown in Table 4-3, clearly demonstrate the essentially complete removal of the settleable fraction (100% for BOD and 95% for TSS) and progressively reduced removal of the supracolloidal (91% of BOD and 92% of TSS) and colloidal (66% of BOD) fractions. This progression runs counter to the frequently noted biological reaction rate vs particle size relationship (Levine, et. al., 1991). Therefore, the primary mechanism for removal of TSS and associated pollutants (BOD, organic nutrients, metals and toxic organics) is not biological in nature. This would appear to be reinforced by the lack of dissolved oxygen, high oxygen demand, and the slow nature of anaerobic biological reactions which are the predominant biological mechanisms.

The solids that are removed undergo incomplete anaerobic decomposition (acidification) resulting in a release of nitrogen, phosphorus, and carbon in the form of volatile fatty acids. The amount of accumulated internal load depends on the length of time the water temperature stays below 5-10°C since this material does not undergo significant decomposition until the water temperature increases above this threshold value. The longer the uninterrupted period of less than 5-10°C, the greater the initial load and its effect on dissolved BOD at temperatures above this threshold. In most temperate North American climates, the release of this accumulated organic material expresses itself mostly in the late spring and in the early summer, similar to oxidation pond "spring turnover". Some of these impacts are noted by the comments within Figure 4-14, which show how some of these phenomena might impact removal patterns.

Non-degradeable material is removed, accumulates and is compressed forming an organic layer of biologically recalcitrant material in the sediments of zone 1. The layer is thicker near the influent end of the wetland and gets shallower in the direction of flow. This delta of accumulated solid material can eventually reduce the HRT and the available solids storage volume of the wetland. These losses are also exacerbated by accumulated plant detritus. These accumulated solids ("sludge" or "biosolids") will occasionally need to be removed and managed, e.g., directly land applied and plowed under as a soil amendment or through some other method as directed by the regulatory authorities.

The reduction in wetland volume due to settled solids, living plants and plant detritus can be significant over the long term. The rate of accumulation of settled suspended solids is a function of the water temperature, mass of influent TSS, the effectiveness of TSS removal, the decay rate of the volatile fraction of the TSS, and the settled TSS mass which is non-volatile. The plant detritus buildup is a function of the standing crop and the decay rate of the plant detritus. Accumulation for emergent vegetated areas of the Arcata enhancement wetlands was measured to be approximately 12 mm/year of detritus on the bottom due to plant breakdown and 12 to 25 mm/year of litter forming

a thatch on the surface (Kadlecik, 1996). The volume of the living plants, specifically the volume of the emergent plants, ranged from 0.005 m³/m² (low stem density, water depth of 0.3 m) to 0.078 m³/m² (high stem density, water depth of 0.75 m). This accumulation is more or less constant from year to year as the wetland matures. The total volume reduction under the initial vegetated zone can be estimated using a mass balance equation:

$$V_r = [(V_{ss})(t) + (V_d)(t)] A_w \quad (4-11)$$

where:

- V = volume reduction over period of analysis (m³),
- V_{ss} = volume reduction due to non-volatile TSS and non-degradable volatile TSS accumulation (m³/ha-yr),
- V_d = volume reduction due to non-volatile detrital accumulation as a function of annual production (m³/ha-yr),
- A_w = fully vegetated wetland area (ha),
- t = period of analysis usually (years).

The loss of volume per hectare over a ten year period for a 1 hectare fully vegetated FWS wetland zone with a depth of 0.75 m can be estimated by use of this equation. Based on information in Middlebrooks, et al, (1982) and Carre, et al, (1990) a reasonable default value for V_{ss} when treating raw wastewater in lagoons) would be 200 to 400 m³/ha-yr (2 to 4 cm/yr). Therefore, a conservative default value of 150 m³/ha-yr can be used. One hundred percent coverage of emergent vegetation was measured to contribute 120 m³/ha-yr of bottom detritus, and 120 m³/ha-yr of surface litter with a standing crop volume of 412 m³/ha. Substituting into the equation for a 10-year analysis yields:

$$V_r = [150)(10) + (240)(10)] 1.0 = 3,900\text{m}^3$$

Table 4-5 provides additional examples of wetland volume loss due to TSS and plants detritus. Based on the actual Arcata experience, it is clear that use of equation 4-11 is a conservative means of estimating volume reduction from TSS deposition and detrital accumulation.

Using the initial fully vegetated zone volume (V_i) and adding the standing crop (V_{sc}), the total loss of volume can be estimated by addition to be 4,312 m³. Since the original volume is area (10,000 m²) times depth (0.75 m) or 7,500 m³, the total loss of volume would be 4,312/10,000 or 43%. This corresponds to a new porosity (ϵ) of 0.57. As noted earlier dense, mature stands of emergent plants are assumed to have a porosity of about 0.65.

Table 4-5. Examples of Change in Wetland Volume Due to Deposition of Non-Degradable TSS (V_{ss}) and Plant Detritus (V_d) Based on 100% Emergent Plant Coverage (Gearheart, et al, 1998) Influent TSS.

(mg/L)	V_{ss} (m ³ /yr)ha)		V_d (m ³ /ha/yr)
	50% removal	75% removal	
40	75	113	240
60	80	112	150
168	225	240	240

The accumulation computed above indicate that the call is nearly ready for residual solids removal, as its excess storage capacity is essentially used up. However, the Arcata facility for which the accumulation measurements were made is still performing well after 12 years (USEPA, 1999). The loss of volume and porosity computed by the previous method is obviously conservative, but illustrates how one could conservatively estimate the loss of porosity in the initial settling zone.

When designing the primary wetland cell treating oxidation pond effluent the designer should consider this cumulative problem by increasing the depth of the inlet zone (up to 1.0m) to lengthen the period before solids removal would be required. The designer should also provide for easily accessible solids removal in this zone. There may be a need to harvest vegetation and related detritus to maintain fully vegetated and open-water areas in proper proportion. Such controlled harvesting may be extended into the fully vegetated zones to reduce the apparent loss of effective treatment volume and delay the need to remove accumulated solids.

The fully vegetated, anaerobic zone 1 of the FWS wetland should be designed based upon the average maximum monthly flow rate (Q_{max}) to assure the potential for effective removal of solids during periods of high flow. To facilitate solids removal and handling, this initial compartment should be designed as at least two equally sized wetlands with a 0.6 to 0.9 m operating depth, which can be operated in parallel. This would allow taking one cell out of operation for maintenance work such as for solids removal, vegetation removal, or replanting.

4.5.3 Design Examples

Design Example 1 - BOD and TSS to meet secondary effluent requirements

Design a FWS wetland to treat lagoon effluent to meet a monthly average 30 mg/l BOD and TSS discharge objective. The community has a design population of 50,000 people with an average annual design flow of 18,920 m³/day (5 MGD) (Q_{ave}). Use design loading factors from sections 4.4 and 4.5 to meet a 30 mg/l BOD and TSS effluent standard. Since a single fully vegetated FWS system can be employed with maximum areal loading rates for these systems are 40 kg BOD/ha-d and 30 kg TSS/ha-d. Facultative lagoon effluent typically averages from 30 to 40 mg BOD/L and 40 to 100 mg TSS/L, with the latter being much more variable due to seasonal algal growth and spring and fall overturn periods (WEF, 1998; Middlebrooks, et al, 1982). For this example the average FWS influent BOD is 50 mg/l at Q_{ave} (18,920 m³/d), while the average TSS is 70 mg/L at this flow. At the maximum monthly flow (Q_{max}) of 2 x Q_{ave} the BOD is 40 mg/L and TSS is 30 mg/L.

Step 1 - Apply areal loading rates(ALR) to average (Q_{ave}) and maximum monthly flow (Q_{max}) conditions to identify the critical conditions for sizing of the facility.

$$ALR = Q Co/A_w \quad (4-12)$$

where:

ALR = areal loading rates: BOD = 40 kg /ha-d ; TSS = 30 kg /ha-d

Q_0 = incoming flow rate, in m³/d

C_0 = influent concentration, in mg/L

A_w = total area of FWS, in ha

which for BOD yields:

$$\text{for } Q_{ave}, A_w = (18,920 \text{ m}^3/\text{d})(1000 \text{ L/m}^3)(50 \text{ mg/L}) / (40 \text{ kg/ha-d})(106 \text{ mg/kg}) = 24 \text{ ha}$$

$$\text{for } Q_{max}, A_w = (37,840) (40) / (40) (106) = 38 \text{ ha}$$

Similarly, for TSS:

$$\text{for } Q_{ave}, A_w = (18,920) (70) / (30)(106) = 44 \text{ ha}$$

$$\text{for } Q_{max}, A_w = (37,840)(30) / (30)(106) = 38 \text{ ha}$$

Therefore, the limiting condition is the TSS loading at average flow conditions, where 44 hectares are required to meet secondary effluent standards with a fully vegetated, single-zone FWS system. However, it has been previously shown that open water zones permit higher areal loading rates (from section 4.4), so the sizing can be recomputed on that basis following the same procedure. From that analysis, with BOD and TSS loading rates of 60 and 50 kg/ha-d, respectively, the critical condition is still the average flow condition and the TSS areal loading, but with a requirement of 26 ha instead of 44 ha.

Step 2 - Determine the theoretical HRT(days) using equation 4-4, assuming $h = 0.6 \text{ m}$ and $\epsilon = 0.75$ in vegetated zones (1 and 3) and $h = 1.2 \text{ m}$ and $\epsilon = 1.0$ in the open zone (2). The combined estimate is an average depth of 0.8 m and an average $\epsilon = 0.8$. Therefore, the first estimate is for overall HRT, followed by individual cell estimates.

$$\begin{aligned} \text{for } Q_{ave}, t &= \frac{V_w \epsilon}{Q_{ave}} = \frac{A_w h \epsilon}{Q_{ave}} \\ &= \frac{(26 \text{ ha})(10,000 \text{ m}^2 / \text{ha})(0.8 \text{ m})(0.80)}{18,920 \text{ m}^3/\text{d}} \\ &= 8.9 \text{ days} \end{aligned}$$

$$\text{for } Q_{max}, t = 4.5 \text{ days}$$

This last calculation implies that at the maximum monthly flow the overall HRT may not be adequate for the necessary treatment mechanisms to perform. If these relatively equal-sized zones are employed as a first approximation, there would be less than one day of theoretical HRT in each at this maximum flow condition. For zone 1 the minimum HRT at Q_{max} should be about 2 days, making 4 days at Q_{ave} .

For zone 2 there is an upper limit which depends on climate and temperature. In this example, the concept is

that the open-water area will have an HRT exceeding that which is required for an algal bloom, creating a significant additional loading on zone 3. The time required for this condition varies with temperature, e.g., shorter in hotter climates. For most U.S. conditions a maximum HRT of about 2 to 3 days should avoid most blooms. On the other hand, the longer the HRT in zone 2, the better the reduction in soluble organics, ammonia-nitrogen and fecal coliforms. Therefore, the designer should consider isolation of this zone from the fully-vegetated zones that precede and follow it and provide some flexibility in HRT control independent of the other zones to optimize this zone's treatment performance. For this exercise a minimum HRT of 2 days is chosen, making the average HRT 4 days at average flow.

Zone 3 should be provided the same design considerations as zone 1, since it functions in the same manner. Depending on the performance of zone 2, it may also provide denitrification in addition to flocculation and sedimentation. Therefore, it should have approximately the same HRT as zone 1.

The minimum HRT at Q_{max} is therefore $2 + 2 + 2 = 6$ days, and the average 12 days with the assumptions chosen in this example. This would then require (using equation 4-4) an overall wetland area of:

$$A_w = (t)(Q)/(h)(\epsilon) \\ = (12 \text{ d})(18,920 \text{ m}^3/\text{d}) / (0.8 \text{ m})(0.80)(10,000 \text{ m}^2/\text{ha}) \\ = 35 \text{ ha}$$

Applying the normal additional area for buffers and setbacks of 1.25 to 1.4, the total area required for the FWS facility is 45 ha (135 acres).

Step 3. - Configuration

Given the high TSS of the influent stream and the potential for short circuiting, the system should be designed with two parallel treatment trains of a minimum of three cells in each. The first cells in each train should normally each get 50% of the flow and may have a deeper (1.0 m) inlet area directly adjacent to the inlet structure to handle any discrete solids settling which might occur at this location. This design option would add approximately one day to the overall HRT, and would only be chosen in situations where pretreatment is likely to allow escape of readily settleable particulates. Multiple cells allow for redistribution of the primary cell effluent in the subsequent cell which reduces short-circuiting. Flexible intercell piping will facilitate maintenance without a major reduction in the necessary HRT to produce satisfactory effluent quality. Aspect ratios of the cells should be greater than 3:1 and adapted to the site contours and restrictions. Additional treatment will likely be required after the FWS system to meet fecal coliform and dissolved oxygen permit requirements.

Design Example 2 - BOD and TSS \leq 20mg/L Effluent Requirements

To meet this effluent quality an open-water zone will be required in the FWS. From Section 4.4.3 the critical load-

ings to meet these effluent concentrations are 45 kg BOD /ha-d and 30 kg TSS /ha-d. Using the same influent conditions in the first example, the steps of preliminary sizing are the same.

Step 1 - Apply areal loading to determine the FWS system's critical sizing conditions using equation 4-12.

$$\text{BOD: at } Q_{ave}, A_w = (18,920)(50)(1000)/(45)(106) \\ = 21 \text{ ha} \\ \text{at } Q_{max}, A_w = (37,840)(40)(1000)/(45)(106) \\ = 34 \text{ ha}$$

$$\text{TSS: at } Q_{ave}, A_w = (18,920)(70)(1000)/(30)(106) \\ = 44 \text{ ha} \\ \text{at } Q_{max}, A_w = (37,840)(30)(1000)/(30)(106) \\ = 38 \text{ ha}$$

The limiting condition is again the TSS loading at Q_{ave} where 44 hectares are required. This is a larger requirement than in the previous example, as would be expected since more stringent effluent requirements are being met.

Step 2 - Determine the theoretical HRT (t) required for the entire 3-zone FWS system and each specific zone using equation 4-4, assuming an overall average depth (h) of 0.8 m and an overall porosity (ϵ) of 0.8.

$$\text{for } Q_{ave}, t = \frac{(44 \text{ ha})(10,000 \text{ m}^2 / \text{ha})(0.8 \text{ m})(0.8)}{19,920 \text{ m}^3 / \text{d}} \\ = 14.9 \text{ days}$$

$$\text{for } Q_{max}, t = 7.4 \text{ days}$$

Returning to individual zones and assuming an equal minimum HRT in each, equation 4-4 is used in dimensioning at maximum flow conditions:

$$A_2 = \frac{(2.5 \text{ d})(37,840 \text{ m}^3 / \text{d})}{(1.0)(1.2 \text{ m})(10,000 \text{ m}^2 / \text{ha})} \\ = 7.9 \text{ ha}$$

Therefore, the area for zones 1 and 3 are:

$$A_3 = A_1 = (44 - 7.5) / 2 \\ = 18 \text{ ha}$$

The overall FWS system area, including buffers, would be about 58 hectares (145 acres).

Step 3 - Configuration

Again the use of parallel trains is encouraged for all the same reasons as noted in the previous example. Parallel trains of 3 cells in each are recommended which allow any single cell in a train to be removed from service with transfer of its influent to the same zone cell.

By using an aspect ratio in the range of 3 to 5:1 and complete-cell-width inlets and outlets the intercellular transfers should be simplified.

Design Example 3 - Estimating from examples 1 and 2.

For design example 1, if the influent to the FWS system was facultative lagoon effluent, it would be reasonable to expect the characterization in Table 4-6, with cognizance that the impact of climate and season on the performance of lagoons and the characteristics of municipal wastewaters vary by orders of magnitude. However, the numbers in the table are within the normally expected ranges. To test the areal loading information presented earlier in this chapter, the loading factors for each chemical constituent can be computed using equation 4-12. These yield a TKN loading of 10.8 kg/ha-d for example 1 and 8.6 kg/ha-d for example 2. Similarly, the TP loadings are 2.7 kg/ha-d and 2.1 kg/ha-d for examples 1 and 2, respectively.

Comparing these loadings to Figure 4-5, it is impossible to accurately predict effluent quality for example 1, but it appears that little removal could be expected had the original fully vegetated approach been taken. Mechanistically, the primary mechanisms which are available for TKN removal in zone 1 are flocculation and sedimentation of organic N. Since there are only 4 mg/L of organic N the realistic maximum expectation would be a removal of all but 1 mg/L, while the NH₄-N may be mostly assimilated by the plants during the active growing rate computed for this example, but most would be returned to the water column during senescence. Therefore, the effluent TKN could average anywhere between about 15 and 20 mg/L, depending on the season, and an overall removal of about 2 to 3 mg/L. With the final open-water design of this example, it is not possible to predict removal without more data from open-zoned systems. As in example 2, the three-zone FWS is likely to produce an effluent TKN of greater than 4 mg/L since all three such systems on the figure were loaded at a lower rate. Actual removal would depend upon nitrification accomplished in zone 2, which would be a function of temperature, HRT and dissolved oxygen in that zone. Since the TKN loading rate is about 4 to 5 times the highest one in the figure for open water systems, a conservative approach might be that one-fourth of the nitrogen might be nitrified in the open zone and denitrified in zone 3. This would yield an additional 4 mg/L to the 3 assumed for example 1. This would yield a removal of 7 mg/L and an effluent TN of about 13 mg/L which could vary from about 10 to 16 mg/L during the year depending on plant condition and temperature. Conversely, the systems shown in the figure may have had excess capacity in zone 2 to fully nitrify all the ammonium-nitrogen and the same effluent concentration for the lightly loaded open-water systems could also be attained. By having an open-water zone where nitrification can occur, the inherent denitrification ca-

pability of the subsequent fully-vegetated zone creates a potent opportunity for nitrogen control. It is also feasible in the open-water zone to enhance NH₃ volatilization, but this mechanism is less likely to be significant owing to the limited size of zone 2 which may not permit increased pH which would enhance volatilization. Such estimates are extremely tenuous until more data is generated on higher loadings to these open water FWS systems, and in the interim the designer would be wise to perform pilot studies where nitrogen limits are part of effluent permit requirements.

Areal loading data on total phosphorus (TP) in Figure 4-6 are inconclusive. The TADB (USEPA, 1999) would suggest that these example loadings could produce an effluent of 3.0 to 4.5 mg/L. At the loadings indicated in these examples, the data of Gearheart (1993) would allow for an overall annual average removal of approximately one mg/L. This would provide a similar effluent for both examples of about 4 mg/L. The dominant removal mechanisms in both examples are flocculation and sedimentation of organic phosphorus, but plant uptake and release will cause the effluent to vary from background levels in the growth-phase to levels at or above the influent concentration during the senescent-phase. This discussion does not include the startup-phase where TP removal will occur for several months until the soil's phosphorus adsorption capacity is reduced to an equilibrium level by satisfaction of the soil's calcium, aluminum and iron adsorption sites and completion of the initial growth phase of the plants.

Fecal coliform (FC) removal is limited by the natural background which is depicted in Table 4-4. Figure 4-10 shows that FC removal is based on enhanced sedimentation and flocculation in the fully-vegetated zone of an FWS. Therefore, approximately one log (90%) of removal can be safely estimated in that zone. With an open-water zone, the FWS can take advantage of the natural solar disinfection which is described in the international lagoon literature (Mara, 1975). This additional kill of FC is limited by the HRT in the open-water zone and is a temperature-dependent function with first-order kinetics. Time limitation and single-cell hydraulics will likely limit additional kill to about one log. Since in zone 3 FC removal would be by sedimentation, less than one additional log of removal could be expected.

Based on the prior analyses the total removal for examples 1 and 2 would be 2+ logs of kill, with an expected effluent FC count of ≤100/100ml. A fully vegetated system which has no open zone would likely remove somewhere between 1 and 2 logs to produce an effluent with several hundred FC/100ml. Both would experience a natural variation about those means as discussed earlier in the chapter. One major reason for periodic increases will be wildlife attraction to open water zones. However, with the requirement that the outlet be located at the terminus of the subsequent fully-vegetated zone 3, the impacts of wildlife should be minimized. However, some spikes of fecal coliform may still be evident.

As noted earlier, the impact of the example designs on metals and toxic organics will vary also. Most metals will

Table 4-6. Lagoon Influent and Effluent Quality Assumptions.

Parameter	Raw Wastewater	Lagoon Effluent
TKN(mg/L)	40	20
NH ₄ -N(mg/L)	10	16
TP(mg/L)	7	5
FC(#/100ml)	106	104

likely be removed with the TSS by physical means, and effluent metals will probably be similar in ratio to the two TSS effluent concentrations. The average pond effluent had a TSS of 70 mg/l and the two FWS designs should yield 30mg/L and 20mg/L, respectively. Therefore, design examples 1 and 2 should remove about 70% of the heavy metals. Since each metal reacts differently this type of analysis has little meaning. Typically, nickel, boron, selenium and arsenic are more resistant to removal by sedimentation than most of the other commonly measured metals. A similar discussion can be provided with regard to semi-volatile toxic organic compounds. Both classes of pollutants may be associated with certain effluent particle-size fractions, which will cause them to follow the removal patterns discussed earlier in concert with Table 4-3.

4.6 Design Issues

This subsection describes issues that are important in the design and layout of a FWS constructed wetland. These design issues are separate from wetland area determinations already described. However, it is important for the engineer/designer to understand that design issues and wetland area determinations are both important. The design issues outlined here are intended to maximize the treatment potential of FWS constructed wetlands and may impact the wetland area determined from the wetland sizing steps, which should be considered the starting point for a FWS constructed wetland design. Many of the design issues outlined below are based on experience with FWS constructed wetland systems currently in operation.

4.6.1 Wetland Layout

4.6.1.1 Site Topography

In many cases, the topography of the site will dictate the general shape and configuration of the FWS constructed wetland. On sloping sites, for example, constructing the long dimension of the wetland parallel to the existing ground contours helps minimize grading requirements. With proper design, sloped sites can reduce pumping costs by taking advantage of the existing hydraulic gradients.

4.6.1.2 Aspect (length to width) Ratio

The aspect ratio (AR) or length to width ratio (L/W), of a FWS wetland system is defined as the average length divided by the average width, and can be expressed as:

$$AR = \frac{L}{W} \quad (4-13)$$

where:

- L = average length of wetland system, and
- W = average width of wetland system.

FWS constructed wetlands have been designed with ARs from less than 1:1 to over 90:1. Generally, FWS constructed wetlands are designed and built with an AR greater than 1:1. It has been suggested that wetlands with higher ARs help to minimize short circuiting, and force the wetland to

more closely conform to plug flow hydraulics (Gearheart, 1996; Dombeck, 1998). However, results of dye studies on existing FWS constructed wetlands have shown that many wetlands deviate from ideal plug flow hydraulics independent of the AR. For wetland systems with very high length to width ratios, careful consideration needs to be given to headloss and hydraulic gradient considerations to avoid overflows of confining dikes near the influent end. Use of equation 4-6 and the material in section 4.3.2.2 will permit the designer forced to use high AR cells to evaluate each assumption and make corrections as necessary. When conducting a hydraulic grade line analysis to determine if the backwater is at an acceptable elevation near the inlet, the outlet level is normally assumed to be at the midpoint.

4.6.1.3 Wetland configuration

The shape of a FWS constructed wetland can be highly variable depending on site topography, land configuration, and surrounding land use activities. FWS constructed wetlands have been configured in a number of shapes, including rectangles, polygons, ovals, kidney shapes, and crescent shapes. There is no data that supports one FWS constructed wetland shape as being superior in terms of constituent removal and effluent quality, over another shape. However, any wetland shape needs to be designed and configured following the general guidelines of this report. Design concerns such as hydraulic retention time, short-circuiting, headloss, inlet/outlet structures, and internal and surface configurations can significantly impact wetland effluent quality.

4.6.1.4 Multiple cells

It has been shown in both the design of oxidation ponds and FWS constructed wetlands, that a number of cells in series can consistently produce a higher quality effluent. This is based upon the hydrodynamic characteristics that constituent mass is gathered at the outlet end of one cell, and redistributed to the inlet of the next cell. This process also minimizes the short circuiting effect of any one unit, and maximizes the contact area in the subsequent cell. For treatment and water quality purposes, it is recommended that a FWS constructed wetland should consist of a minimum of three cells in series. Open water zones have also been used to redistribute flows, but their value in this regard has been overshadowed by their other attributes.

Large wetland cells can have internal berms running parallel to the flow direction, effectively creating smaller parallel cells with better hydraulic properties. Multiple cells with appropriate piping between them offer greater operational flexibility. In the event that a wetland cell needs to be taken off line for maintenance reasons, the remaining cell or cells can remain operational. This is made even more important if cells are sized to coincide with zoning. Completely vegetated and completely open cells are easier to maintain and are more flexible when sequencing or independent cell HRT adjustments or maintenance is required.

4.6.2 Internal Wetland Components

4.6.2.1 Open water/Vegetation ratio

The location of emergent vegetation, the type and density of this vegetation, and the climate as it relates to plant senescence are important factors in the design of a FWS constructed wetland. Providing adequate open water areas is an important, but often overlooked, component in the design and implementation of FWS constructed wetlands (Gearheart, 1986; Hammer, 1996; Hamilton, 1994, Stefan et al., 1995). Open water is defined as a wetland surface which is not populated by emergent vegetation communities, but may contain submergent aquatic plants as well as unconsolidated groupings of floating aquatic plants. Historically, many FWS constructed wetlands were designed and built as fully vegetated basins with no designated open water areas. Many of these systems proved problematic with very low or no water column dissolved oxygen, that resulted in odor production and vector problems.

Natural wetlands generally contain a mix of open water and emergent vegetation areas. The open water areas provide many functions such as oxygenation of the water column from atmospheric reaeration, submerged macrophytes, and algal photosynthesis. They also permit predation of mosquito larvae by fish and other animals and provide habitat and feeding areas for waterfowl. Open water areas in FWS constructed wetlands will not only provide the same functions as for natural wetlands, but will also provide the opportunity for increased soluble BOD reduction and nitrification of wastewater because of the increase in oxygen levels. It is recommended that a FWS constructed wetland not be fully vegetated, but should include some open water areas. Open water areas in a FWS constructed wetland will result in a more complex, dynamic, and self-sustaining wetland ecosystem, that better mimics a natural wetland. Open water wetlands have lower background BOD than fully vegetated wetlands (see Table 4-4), which reflects their improved treatment potential.

The ratio of open water to emergent vegetation depends on land availability, costs, and the function and goals of the FWS constructed wetland system. Generally speaking zones 1 and 3 should be 100% vegetated with the zone 2 surface having > 50% to 100% open water. If denitrification is required, the 3rd zone which is 100% vegetated will accomplish it. The open-water zones with an HRT in excess of 3 days may invite algal blooms. As long as this zone is followed by a fully vegetated zone with an HRT of 2 or more days, this should not represent a problem beyond increased biomass management requirements.

The most effective method used for creating open water areas in a single cell is to excavate a zone that is deep enough to prevent emergent vegetation colonization and migration. Some have periodically raised water levels to a depth that limits emergent vegetation growth, but this is operationally demanding and may have negative treatment impacts. The type of dominant macrophyte (i.e., emer-

gent or submergent) can be controlled by controlling the operating depth. Water column depths greater than approximately 1.25 to 1.5 meters planted with submergents such as *Potamogeton* spp., will not rapidly be encroached upon by emergent macrophytes like bulrushes, reeds, and cattails. If the water column depth is between 0.5 to 1.0 meters and planted with emergent vegetation, such as bulrush and cattails, they will prevail over submergents and most other emergents by filling in the surface area through rhizome and tuber propagation. The seasonal change in water levels (hydroperiod) is also a determinant in establishing various aquatic macrophyte communities.

Due to the lack of shading, significant blooms of algae can occur in large open water areas, which can have negative effects on effluent quality. To help minimize the potential for algal growth, open water areas should be designed for less than 2 to 3 days hydraulic retention time. In general, the growth cycle of algae is approximately 7 days, so providing open water areas with less than 2-3 days retention time will help minimize algal growth in the open-water zone of the wetland. Sufficient standing crops of submergent macrophytes may also limit algal regrowth in these zones. Conversely, excessive algal growth may impair the performance of the submergent macrophytes by limiting the solar energy which reaches them.

Guidelines for designing a FWS constructed wetland in terms of vegetated covering are as follows: Begin with an emergent vegetation zone covering the volume used in the first 2 days of retention time at maximum monthly flow (Q_{max}) to provide for influent solids flocculation and separation. The emergent zone should be followed by an open water zone covering days 3 and 4 in the retention time sequence at Q_{max} . The open water zone should be designed to facilitate production of dissolved oxygen to meet CBOD and NBOD demands. The final 2 days of hydraulic retention volume at Q_{max} should be an emergent wetland to reduce any solids (algae, bacteria, etc.) generated in the open water and to supply carbon (decomposing plant material) and anoxic conditions for denitrification. It is also recommended that this final stand of emergent vegetation be as close as possible to the outlet of a FWS constructed wetland. This provides a final level of protection just before the effluent leaves the wetland to minimize the impact of wildlife on effluent quality. This recommendation may heighten the maintenance requirements for the outlet device, but it will result in less variability in the effluent quality.

4.6.2.2 Inlet Settling Zone

Depending on the pretreatment process, a substantial portion of the incoming settleable and suspended solids may be removed by discrete settling in the inlet region of a FWS constructed wetland. For example, if the FWS system is to follow an existing treatment facility which is prone to produce high concentrations of settleable TSS, an inlet settling zone should be used. If the pretreatment facility does a good job of solids capture, but has a high concentration of soluble constituents, an inlet settling zone is of

no value. Given that FWS systems are generally preceded by lagoon systems which seasonally produce large TSS concentrations, primarily due to algal mass, the need for an inlet settling zone would be marginal since algal solids will require flocculation and sunlight restriction before becoming settleable.

If an inlet settling zone should be desired, it should be constructed across the entire width of the wetland inlet. A recommended guideline is to design a settling zone which provides approximately 1 day hydraulic retention time at the average wastewater flow rate, as most settleable and suspended solids are removed within this time period. The settling zone should be deep enough to provide adequate accumulation and storage of settled solids, but shallow enough to allow the growth of emergent vegetation, such as bulrush and cattails. Recommended depth is approximately 1 meter.

Most accumulated organic solids will slowly decay and reduce in volume. This decay is one of the two major sources of internal loading and background constituents in the effluent. However, at some time in the future the remaining accumulated solids will need to be removed from the settling zone.

4.6.2.3 Inlet/Outlet Structures

Placement and type of inlet and outlet control structures are critical in FWS constructed wetlands to ensure treatment effectiveness and reliability. To effectively minimize short-circuiting in a FWS constructed wetland, two goals concerning cell inlet/outlet structures are critical: (1) uniform distribution of inflow across the entire width of the wetland inlet, and (2) uniform collection of effluent across the total wetland outlet width. Both of these should minimize localized velocities, thus reducing potential resuspension of settled solids. It is important that any outlet structure be designed so that the wetland can be completely drained, if required. Some of the common types of wetland inlet/outlet systems in use today, and general guidelines regarding their design are further discussed in Chapter 6.

Depending on the type of wastewater influent, the inlet structure discharge point could be located below or above the wetland water surface. Perforated pipe inlet/outlet structures can be difficult to operate and maintain when they are fully submerged. All inlet distribution systems should be accessible for cleaning and inspection by using cleanouts.

Outlet structures represent an operational control feature that directly affect wetland effluent quality. It is important that outlet structures facilitate a wide range of operating depths. By adjusting the outlet structure, both the water depth and hydraulic retention time can be increased or decreased. This and the need to accommodate cell drainage usually results in locating the outlet manifold at the bottom of the outlet zone. The differences in water quality between water depths can also be highly variable. An outlet

structure design which allows for maximum flexibility of collection depths may be desirable, but may not always be compatible with collection devices that minimize short-circuiting. With this type of design, the outlet structure can be adjusted to draw wetland effluent from the water depth with the best water quality. This alternative design usually involves multiple drop boxes with openings at different depths. In most cases however the uniform collector set at the bottom is favored owing to its inherent advantages in terms of improved effluent quality and facilitation of cell drainage.

Two types of inlet/outlet structures are commonly used in FWS constructed wetlands. For small or narrow (high AR) wetlands, perforated PVC pipe can be used for both inlet and outlet structures. The length of pipe should be approximately equal to the wetland width, with uniform perforations (orifices) drilled along the pipe. The size of the pipes, and size and spacing of the orifices will depend on the wastewater flow rate and the hydraulics of the inlet/outlet structures. It is important that the orifices be large enough to minimize clogging with solids. Perforated pipes can be connected to a manifold system by a flexible tee joint, which allows the pipes to be adjusted up or down. In some cases wetland designers with this type of inlet/outlet structure will cover the perforated pipes with gravel to provide more uniform distribution or collection of flows. This type of inlet/outlet structure requires periodic inspection, some operation and maintenance to maintain equal flow through the pipe, and access at the end to clean clogged orifices.

For larger wetland systems, multiple weirs or drop boxes are generally used for inlet and outlet structures. Weirs or drop boxes are generally constructed of concrete, but smaller PVC boxes are also available. These structures should be located no further apart than every 15 m (center to center) across the wetland inlet width, with a preferred spacing of 5 to 10 m. The same spacing requirements apply for the outlet weirs or drop boxes. Depending on the source of the wastewater influent, the inlet weirs or drop boxes can be connected by a common manifold pipe. Whatever the configuration, it is important that the manifold pipes and weirs be hydraulically analyzed to attain reasonably uniform distribution. Simple weir or drop box type inlet structures are relatively easy to operate and maintain.

Weir overflow rates have not been considered in the design of most wetlands. Weir loading rates of existing wetlands are significantly higher than those required in most biological solids removal processes (i.e., 120 to 190 $m^3/m.d$) (WEF, 1998). Excess weir rates can cause high water velocities near the outlet which could entrain solids which would otherwise be removed from the effluent. Therefore, weir loading rates should be designed to meet the above range for best performance until more quantitative data are generated.

4.6.2.4 Baffles

Baffles are internal structures installed either perpendicular or parallel to the direction of flow. Baffles can be

effective in reducing short-circuiting, for mixing waters of different depths, and for improved flocculation performance. Properly designed and placed open water zones can also act as baffles by allowing mixing and redistribution of wastewater before it enters into the next wetland vegetated zone. The use of baffles depends on cell configurations, aspect ratios, treatment goals, and permit compliance. In general, except for special circumstances unforeseen in typical municipal wastewater treatment application the use of such structures is not recommended. However, their use in correcting problems which are due to hydraulic flow difficulties (short circuiting, dead zones, etc.) make them useful to the operator-owner.

4.6.2.5 Recirculation

Recirculation is the process of introducing treated effluent back to the inlet or to some other internal location of the wetland. Recycling effluent can decrease influent constituent concentrations and increase dissolved oxygen concentrations near the inlet. The increased dissolved oxygen concentrations can help reduce inlet odors, lower BOD, and enhance nitrification potential in open-water zones. If recirculation is to be considered, the effects of recirculation on the wetland water balance and wetland hydraulics need to be analyzed. In general, the ability to recycle, like the ability to drain each cell, could be considered part of the need to have flexible piping, multiple cells, and multiple trains of cells. The value of recirculation has not been shown to date to be a major factor in improving FWS performance.

4.6.2.6 Flow Measuring Devices

Many existing wetland systems do not have accurate flow measuring devices. Even if accurate estimates of inflows and/or outflows to the treatment plant are known, internal flow distribution to individual wetland cells is not known or measured. Without accurate flow measurements to individual wetland cells, it is impossible to determine internal flow rates, average velocities, and hydraulic retention times for each cell, thus making system performance adjustments difficult. It is recommended that some type of flow measuring device be either installed in or available to be installed in each cell of a FWS constructed wetland. This includes separate flow measuring devices on each inlet for multiple wetland cell configurations. Some examples of flow measuring devices include simple 90° V-notch or rectangular weirs, and more sophisticated Parshall flumes for larger systems. Depending on the size and layout of the wetland, cell inlet/outlet structures should be designed to be compatible with available flow measuring devices.

4.6.3 Pretreatment Requirements

Examples of treatment that should precede FWS constructed wetlands include all types of stabilization ponds and primary sedimentation systems. The use of wetlands to polish secondary effluent to less than 10 mg/l BOD and TSS has been documented, but is not covered in detail here. The reader is directed to USEPA (1999) for guid-

ance in these applications. The effluent entering a FWS constructed wetland should be free from floatable and large settleable solids, and excessive levels of oil and grease. Also important to a FWS constructed wetland is the incoming metal concentrations. While a FWS constructed wetland does remove and immobilize many heavy metals along with the TSS, excessive influent concentrations could result in residuals which are unacceptable for subsequent land application. A source reduction program and/or an industrial waste pretreatment ordinance are required if excessive metals concentrations are present in the raw wastewater.

4.7 Construction/Civil Engineering Issues

Specific construction/civil engineering design issues that should be considered early in the planning and design phase of a FWS constructed wetland project include site topography and soils, berm construction, impermeable liner materials, wetland vegetation substrate, and internal drainage. Many of these issues should be considered during the site selection process, as they may become difficult or costly to correct later in the actual design and construction phases of the project. The construction/civil engineering requirements for a FWS constructed wetland are similar to other earthen water quality management systems such as oxidation ponds, and are discussed in Chapter 6 and in USEPA (1983) and Middlebrooks, et al (1982).

4.7.1 Site Topography and Soils

In general, level land with clay soils affords the optimal physical setting for a FWS constructed wetland. Potential wetland sites with other physical conditions can be used, but may require more substantial engineering, earthwork, construction requirements, and liners. In order to overcome site limitations, the cost of a FWS constructed wetland will also increase proportionally as the wetland site further deviates from optimal site conditions.

FWS constructed wetlands can be built on sites with a wide range of topographic relief. Construction costs are lower for flat sites since sloped sites require more grading and berm construction. Site topography will generally dictate the basic shape and configuration of the FWS constructed wetland.

The principal soil considerations in siting and implementing a FWS constructed wetland are the infiltration capacity of the soils and their suitability as berm material and wetland vegetation substrate. In most cases FWS constructed wetlands are required to meet stringent infiltration restrictions depending on the state regulations for groundwater protection. An exception are wetland systems designed to incorporate infiltration as part of the treatment and discharge process. In these cases, the underlying soil must have infiltration rates compatible with the design discharge rates. If native site soils are not suitable, separate infiltration trenches can be added to increase the infiltration surface area. In some cases, it will be necessary to import berm and/or bottom materials or use synthetic liners (see Chapter 6) to prevent infiltration.

Interior berms containing FWS wetland cells should be built with up to 3:1 side slopes as the soil characteristics allow. A minimum freeboard of 0.6 m above the peak flow operating depth in the wetland is required. For wetlands that will receive exceptionally high peak inflows, additional freeboard may be required to ensure that berm overtopping does not occur. Additional freeboard may also be designed to accommodate long-term solids and peat buildup during the operation of the wetland, and to allow appropriate water depths to be maintained as sludge builds up in the initial cells over time.

All FWS-cell external berms should have a minimum top width of 3 m, which provides an adequate road width for most standard service vehicles. In some cases, internal berms can have smaller top widths, as routine operation and maintenance can be carried out by small motorized vehicles, such as ATVs. Road surfaces should be an all weather type, preferably gravel, which also minimizes direct runoff into the wetland.

Berm integrity is critical to the long term operational effectiveness of FWS constructed wetlands. Common berm failure causes include burrowing by mammals, such as beaver nutria and muskrat, and holes from root penetration by trees and other vegetation growing on or near the berms. Several design features can eliminate and/or minimize these problems. A thin impermeable wall, or internal layer of gravel, can be installed during construction, which will minimize mammal burrowing and/or root penetration. Planting the berm using vegetation with a shallow root system can also be effective. Unlike oxidation ponds, berm erosion in fully vegetated zones and/or cells from wave action is generally not a concern due to the dampening effect of the wetland vegetation. However, in larger cells with open zones it could be an issue, and stabilization pond texts should be consulted for solutions (Middlebrooks, et al, 1982)(USEPA, 1983).

In the design and site selection process, an important consideration is the amount of additional area required for berms. In general, the higher the aspect ratio for a FWS constructed wetland, the more area that will be required for the berms and for the entire wetland system. This increase in required total wetland area to accommodate berms is more pronounced for smaller wetlands than for larger wetlands. A factor of 1.2 to 1.4 times the cell area is usually employed to determine the total site area for the FWS system.

4.7.2 Impermeable Liner Materials

A concern with FWS constructed wetlands is the potential loss of water from infiltration and contamination of groundwater below the wetland site. While there are some wetland applications where infiltration is desirable, the majority of the applications require some type of barrier to prevent groundwater contamination. Under ideal conditions, the wetland site will consist of natural soils with low permeability that restrict infiltration. However, many wetlands have been constructed on sites where soils have

high permeability. In these cases, some type of liner or barrier will likely be required to minimize infiltration. Liner requirements can also add significantly to the construction cost of a FWS constructed wetland.

Existing natural soils with permeability less than approximately 10^{-6} cm/s are generally adequate as an infiltration barrier. For site soils with higher permeabilities, some type of liner material will likely be required. Some examples of wetland liner materials include imported clay fill, bentonite soil layers, chemical treatment of existing soils, asphalt, and synthetic membrane liners such as PVC or HDPE. In some instances, it will be possible to compact the existing site soils to acceptable permeability. Due to their ability to be placed in shaped wetland cells, clay liners are generally a more sustainable component of the wetland than synthetic membrane liners. Whatever liner material is chosen, an important consideration is to provide adequate soil cover and depth that protects the liner from incidental damage and root penetration from the wetland vegetation (see Chapter 6).

4.7.3 Soil Substrates for Plants

Aquatic macrophytes generally reproduce asexually by tuber runners. Soils with high humic and sand components are easier for the tubers and runners to migrate through, and plant colonization and growth is more rapid. The soil substrate for wetland vegetation should be agronomic in nature (e.g. loam), well loosened, and at least 150 mm (6 inches) deep. Depending on the liner material, deeper soil substrates may be required to protect the liner. If this type of soil layer exists at the site, it should be saved. After the wetland basin, berms and other earthen structures are constructed, and the liner is installed (if required), the original soil substrate can be placed back into the excavated region. To meet soil specifications, it may be necessary to amend the saved soils with other materials.

While soils such as loam and silt are good for plant growth, they can allow large vegetation mats to float when large water level fluctuations occur in the wetland. Floating vegetation mats can significantly alter the treatment capabilities of FWS constructed wetlands by allowing wastewater to flow between the floating mats and substrate, not in contact with any vegetation treatment media. To circumvent this potential problem, denser soil substrates such as a sandy loam, or a loam gravel mix can be used. This will be more important in FWS constructed wetlands where large water depth fluctuations will be part of the operation and maintenance procedure.

4.7.4 Internal Drainage and Flexible Piping

In the event a FWS constructed wetland needs to be drained, the wetland bottom should have a slope of 1% or less. Drainage may be required for maintenance reasons such as liner repair, sludge removal, vegetation management, and berm repair. Deeper channels may be employed to allow for drainage and/or continued use when serial cells are taken out of service. Channels can also be used to

connect deeper open water areas where these are part of a larger cell, rather than separate cells. In general the more complete the intercellular piping, the greater the operational flexibility is for the entire system.

4.8 Summary of Design Recommendations

A summary of the design recommendations for FWS wetland treatment systems is presented in Table 4-7. As more quality-assured data become available allowable pollutant areal loadings will likely be revised.

Table 4-7. Recommended Design Criteria for FWS Constructed Wetlands

Parameter	Design Criteria
Effluent Quality	BOD \leq 20 or 30 mg/L TSS \leq 20 or 30 mg/L
Pretreatment	Oxidation Ponds (lagoons)
Design Flows	Q_{max} (maximum monthly flow) and Q_{ave} (average flow)
Maximum BOD Loading (to entire system) to Meet:	20 mg/L: 45 kg/ha-d 30 mg/L: 60 kg/ha-d
Maximum TSS Loading (to entire system) to Meet:	20 mg/L: 30 kg/ha-d 30 mg/L: 50 kg/ha-d
Water Depth	0.6 - 0.9 m Fully vegetated zones 1.2 - 1.5m Open-water zones 1.0m Inlet settling zone (optional)
Minimum HRT (at Q_{max}) in Zone 1 (and 3)	2 days fully vegetated zone
Maximum HRT (at Q_{ave}) in Zone 2	2 - 3 days open-water zone (climate dependent)
Minimum Number of Cells	3 in each train
Minimum Number of Trains	2 (unless very small)
Basin Geometry (Aspect Ratio)	Optimum 3:1 to 5:1, but subject to site limitations AR > 10:1 may need to calculate backwater curves
Inlet Settling Zone Use	Where pretreatment fails to retain settleable particulates
Inlet	Uniform distribution across cell inlet zone
Outlet	Uniform collection across cell outlet zone
Outlet Weir Loading	\leq 200 m ³ /m-d
Vegetation	
Emergent -	Typha or Scirpus (native species preferred)
Submerged -	Potamogeton, Elodea, etc (see chapter 2).

(continued)

Table 4-7. Continued

Parameter	Design Criteria
Design Porosities	0.65 for dense emergents in fully vegetated zones 0.75 for less dense stand of emergents in same zones 1.0 for open-water zones
Cell Hydraulics	Each cell should be completely drainable Flexible intercell piping to allow for required maintenance Independent, single-function cells could maximize treatment

4.9 References

- Balmer, P. and B. Vik.. 1978. "Domestic Wastewater Treatment with Oxidation Ponds in Combination with Chemical Precipitation," Prog. Water Tech, Vol 10, No. 5-6, pp867-880.
- Carre, J., M. P. Loigre, and M. Leages 1990. "Sludge Removal from Some Wastewater Stabilization Ponds." Water Science Technology, Vol 22, No 3-4, pp 247-252.
- Cole, S. 1988. "The Emergence of Treatment Wetlands". ES&T. Vol 3, No. 5, pp. 218-223.
- Crites, R.W., and G. Tchobanoglous. 1998. "Small and Decentralized Wastewater Management Systems, WCB - McGraw-Hill, NY.
- Dombeck, G. 1998. Sacramento Regional Wastewater Treatment Plant Demonstration Wetland Project. 1997 Annual Report, Nolte and Associates, Sacramento, Ca.
- Frankenbach, R.I and J.S Meyer. 1999. Nitrogen Removal in A Surface Flow Wetland Wastewater Treatment Wetlands, 1999, Wetlands, Volume 1a, No. 2, June 1999 pp.403-412.
- Gearheart, R.A., and B. Finney. 1999. "The Use of Free Surface Constructed Wetlands as An Alternative Process Treatment Train to Meet Unrestricted Water Reclamation Standards", Wat. Sci. Tech. Vol. 40, No. 4-5, pp. 375-382.
- Gearheart, R.A., B. A. Finney, M. Lang, and J. Anderson. 1998. "A Comparison of System Planning, Design and Sizing Methodologies for Free Water Surface Constructed Wetlands". 6th International Conference on Wetland Systems for Water Pollution Control.
- Gearheart, R.A. and B. A. Finney. 1996. Criteria for Design of Free Surface Constructed wetlands Based Upon a Coupled Ecological and Water Quality Model. Presented at the Fifth International Conference on Wetland Systems for Water Pollution Control, Vienna, Austria.

- Gearheart, R. A. 1995. Watersheds - Wetlands - Wastewater Management. In *Natural and Constructed Wetlands for Wastewater Treatment*. Ramadori, R., L. Cingolani, and L. Cameroni, eds., Perugia, Italy, pp 19-37.
- Gearheart, R.A. 1993. "Phosphorus Removal in Constructed Wetlands". Presented at the 66th WEF Conference and Exposition, Anaheim, Ca.
- Gearheart, R.A. 1992. Use of Constructed Wetlands to Treat Domestic Wastewater, City of Arcata, California", *Wat. Sci. Tech.*, Vol. 26, No. 7-8, pp. 1625-1637.
- Gearheart, R.A., F. Klopp, and G. Allen. 1989. Constructed Free Surface Wetlands to Treat and Receive Wastewater Pilot Project to Full Scale, In D.A. Hammer (ed.) *Constructed Wetlands for Wastewater Treatment*, pp. 121-137, Lewis Publisher, Inc., Chelsea, MI
- Gearheart, R.A., B. A. Finney, S. Wilbur, J. Williams, and D. Hall. 1984. "The Use of Wetland Treatment Processes in Water Reuse", *Future of Water Reuse, Volume 2, Proceedings of Symposium III Water Reuse, AWWA Research Foundation*, pp. 617-638.
- Gearheart, R.A., S. Wilbur, J. Williams, D. Hull, B. A. Finney, and S. Sundberg. 1983. *City of Arcata Marsh Pilot Project: effluent quality results-system design and management. Final report. Project No. C-06-2270, State Water Resources Control Board, Sacramento, CA.*
- Gregg, J., and A. Horne. 1993. "Short-term Distribution and Fate of Trace Metals in a Constructed Wetland Receiving Treated Municipal Wastewater", *Environmental Engineering and Health Sciences Laboratory Report No. 93-4. University of California, Berkeley, CA.*
- Hammer, D. 1992. "Creating Freshwater Wetlands", Lewis Publishers, Chelsea, MI
- Hannah, S.A, B.M. Austern, A.E. Eralp, and R.H. Wise, 1986. *Journal WPCF*, Vol 55, No 1, pp 27-34.
- Hovorka, R.B. 1961. An Asymmetric Residence-time Distribution Model for Flow Systems, Dissertation, Case Institute of Technology.
- Kadlec, R.H. 2000. The Inadequacy of First-Order Treatment Wetland Models. *Ecological Engineering*, vol. 15, pp 105-109;
- Kadlec, R.H. and R.L. Knight. 1996. *Treatment Wetlands*. Boca Raton, FL: Lewis-CRC Press.
- Kadlecik, L. 1996. Organic Content of Wetland Soils, Arcata Enhancement Marsh, Special Project, ERE Department Wetland Workshop.
- Levine, A. D., G. Tchobanoglous and T. Asano, 1991. Size Distributions of Particulate Contaminants in Wastewater and Their Impact on Treatability. *Water Research*, Vol. 25, No 8, pp. 911-922.
- Linsley, R.K. Jr., M.A. Kohler, and J.L.H. Paulhus, 1982. *Hydrology for Engineers*, 3rd Ed., McGraw-Hill, NY.
- Mara, D.D. 1975 Proposed Design for Oxidation Ponds in Hot climates. *Journal ASCE-EE* , Vol. 101, No 2, pp 296-300.
- Marais, C. V. R., and V. A. Shaw. 1961. A Rational Theory for the Design of Sewage Stabilization Ponds in Central and South Africa. *Transactions South African Institute of Civil Engineers*, Vol. 3, pp. 205ff.
- Middlebrooks, E. J., C. E. Middlebrooks, T. H. Reynolds, G.Z. Watters, S.C. Reed, and D.B. George. 1982. *Wastewater Stabilization Lagoon Design, Performance and Upgrading*, MacMillan, New York, NY.
- Mitsch, W.J. and J.G. Gosselink. 1993. *Wetlands*. Van Nostrand Reinhold, NY.
- NADB (North American Treatment Wetland Database). 1993. Electronic database created by R. Knight, R. Ruble, R. Kadlec, and S. Reed for the U.S. Environmental Protection Agency. Cincinnati, OH.
- Odegaard, H. 1987. Particle Separation in Wastewater Treatment. In *Proceedings EWPCA 7th European Sewage and Refuse Symposium*, pp. 351- 400.
- Reckhow, K., and S. S. Qian. 1994. Modeling Phosphorus Trapping in Wetlands Using General Models. *Water Resources Research*, Vol. 30, No. 11, pp. 3105-3114.
- Reddy, K. R., and W.R. De Busk. 1987. *Nutrient Storage Capabilities of Aquatic and Wetland Plants for Water Treatment and Resource Recovery*. Magnolia Pub., Inc., Orlando, FL.
- Reed, S. C., R. Crites, and E. J. Middlebrooks, 1995, "Natural Systems for Waste Management and Treatment, McGraw-Hill, San Francisco, Ca.
- Reed, S.C., R.W. Crites, and E.J. Middlebrooks. 1995. *Natural Systems for Waste Management and Treatment*. 2nd Ed., McGraw-Hill, NY.
- Sartoris, J., J. Thullen, L. Barber, and D. Salas. 1999. Investigation of Nitrogen Transformations in a Southern California Constructed Wastewater Treatment Wetland, *Ecological Engineering*, Vol 14, pp. 49-65.
- SCRSD. 1998. *Constructed Wetlands Demonstration Project. 1997 Annual Report*, Sacramento, CA.
- Sparham, V.R. 1970. "Improved Settling Tank Efficiency by Upward Flow Clarification," *JWPCF*, Vo. 42, No 5, pp 801-811.
- Tchobanoglous, G., R. W. Crites, R.A. Gearheart, and S. C. Reed. 2000. A Review of Treatment Kinetics for Constructed Wetlands. Presented to WEF Specialty Conference Disinfection, 2000. New Orleans, LA.

-
- Tchobanoglous, G., F. Meitski, K. Thompson and T.H. Chadwick. 1989. Evolution and Performance of City of San Diego Pilot-Scale Aquatic Wastewater Treatment System Using Water Hyacinths. Research Journal WPCF, Vol 61, No. 11-12, pp 1625-1655.
- Tchobanoglous, G. and E. D. Schroeder. 1985. Water Quality: Characteristics, Modeling, Modification. Addison-Wesley, Reading, MA.
- United Kingdom, Dept. of Environment. 1973. Treatment of Secondary Sewage Effluent in Lagoons. Notes on Water Pollution #63. London, U.K.
- United States Environmental Protection Agency. 1999. FWS Wetlands for Wastewater Treatment: A Technology Assessment. EPA 832/R-99/002. Office of Water, Washington, DC.
- U.S. Environmental Protection Agency. 1988. Design Manual. Constructed Wetlands and Aquatic Plant Systems for Municipal Wastewater Treatment. EPA/625/1-88/022. Cincinnati, OH.
- U.S. Environmental Protection Agency, 1983. Design Manual - Municipal Wastewater Stabilization Ponds. EPA/625/1-83-015. Cincinnati, OH.
- U.S. Environmental Protection Agency, 1993. Manual: Nitrogen Control. USEPA Publication No. EPA/625/R-93/010. Cincinnati, OH.
- Water Environment Federation, 1998. Design of Municipal Wastewater Treatment Plants, 4th Ed, MOP#8. Alexandria, VA.
- Water Environment Federation, 1990. Natural Systems for Wastewater Treatment. MOP FD-16, Alexandria, VA.

Chapter 5 Vegetated Submerged Bed Systems

5.1 Introduction

The pollutant removal performance of vegetated submerged bed (VSB) systems depends on many factors including influent wastewater quality, hydraulic and pollutant loading, climate, and the physical characteristics of the system. The main advantage of a VSB system over a free water surface (FWS) wetland system is the isolation of the wastewater from vectors, animals and humans. Concerns with mosquitoes and pathogen transmission are greatly reduced with a VSB system. Properly designed and operated VSB systems may not need to be fenced off or otherwise isolated from people and animals. Comparing conventional VSB systems to FWS systems of the same size, VSB systems typically cost more to construct, primarily because of the cost of media (Reed et al., 1985). Because of costs, it is likely that the use of the conventional VSB systems covered in this manual will be limited to individual homes, small communities, and small commercial operations where mosquito control is important and isolation fencing would not be practical or desirable.

A conventional VSB system is described in Chapter 2 and depicted in Figure 2-3. The typical components include (1) inlet piping, (2) a clay or synthetic membrane lined basin, (3) loose media filling the basin, (4) wetland vegetation planted in the media, and (5) outlet piping with a water level control system. The vast majority of VSB systems have used continuous and saturated horizontal flow, but several systems in Europe have used vertical flow.

Alternative VSB systems are defined here as VSBs that have been modified to improve their treatment performance (George et al., 2000, Young et al., 2000, Behrends et al., 1996). Typical modifications involve some type of cyclic filling and draining of the system to improve the oxygen input into the media. The potential improvement in performance with alternative VSB systems is offset to some degree by a more complex and expensive operating system. It is too early to predict whether alternative VSB designs will prove to be more cost effective or practical than conventional VSB systems, although they appear to provide significantly better removal of certain pollutants.

This chapter will discuss VSB systems that treat (1) septic tank and primary sedimentation effluents, (2) pond effluents, and (3) secondary and non-algal pond effluents. The

most common VSB systems in the U.S. treat septic tank and pond effluents for BOD and TSS removal. In Europe, VSB systems are most often used to treat septic tank effluents, although they have also been used extensively in the U.K. for polishing activated sludge and RBC effluents, and for treating combined sewer bypass flows (Cooper, 1990, Green and Upton, 1994).

This chapter provides a summary of the theoretical and practical considerations in the design of conventional VSB systems. VSB systems, like other natural treatment systems, are less understood than highly-engineered waste treatment systems because they (1) have more variable, complex, and less controllable flow patterns, (2) have reaction rates and sites within the system that vary with time and location, and (3) are subject to the inconsistencies of climate and growth patterns. This complexity makes the development and use of design equations based on idealized reactor and reaction kinetic theory difficult, if not impractical and unrealistic. Furthermore, because pollutant removal performance can be quite variable, designs must be conservative if a guaranteed effluent quality is required.

5.2 Theoretical Considerations

5.2.1 *Potential Value of Wetland Plants in VSB Systems*

In several recent studies that have compared the pollutant removal performance of planted and unplanted VSB systems, it has been found that plants do not have a major impact on performance (Young et al, 2000, George et al., 2000, Liehr et al., 2000). There is however significant cost and time associated with the establishment and maintenance of the wetland plants in a VSB system. Nevertheless, planted systems have a significant aesthetic advantage over unplanted systems and may be of value as wetland habitat in some cases. Unfortunately, the aesthetic value of plants and the value of VSB wetland systems as wetland habitat are difficult to quantify, and no mitigation credit is given by the USEPA for the habitat value they provide. In the following sections the potential value of wetland plants in VSB systems is discussed in more detail.

5.2.1.1 Type of Wetland Plants

Several studies have attempted to determine if pollutant removal performance differs with various types of wetland

plants (Gersberg et al., 1986, Young et al., 2000). Although some researchers have claimed a relationship, these claims have not been substantiated by others (Gersberg et al., 1986).

It is not clear if it is desirable to maintain a single plant species, or a prescribed collection of plant species, for any treatment purpose. Single plant (monoculture) systems are more susceptible to catastrophic plant death due to predation or disease (George et al., 2000). It is generally assumed that multiple plant and native plant systems are less susceptible to catastrophic plant death, although no studies have confirmed this assumption. Plant invasion and plant dominance further complicate the issue; in several cases researchers have found that, with time and without operator intervention, one of the planted species or an invader species has become the dominant species in all or part of the system (Young et al., 2000, Liehr et al., 2000). This occurs less frequently and more slowly in VSB systems than in FWS systems.

The impact of wetland plants on pollutant removal performance appears to be minimal based on current knowledge, so the selection of plants species should be based on aesthetics, impacts on operation, and long-term plant health and viability in a given geographical area. Local wetland plants experts should be consulted when making the selection.

5.2.1.2 Plant Mediated Gas Transfer

Wetland plants can facilitate gas transfer both into and out of the wastewater of a VSB system. The focus of most studies has been oxygen transfer into the wastewater. However, methane and other dissolved gases in the wastewater can be transferred out of the wastewater by wetland plants. The mechanisms of plant-mediated gas transfer are described in detail in Chapter 3. The potential amount of oxygen transferred by plant roots into the wastewater depends on many factors including dissolved oxygen concentration in the wastewater, root depth in the wastewater, air and leaf temperatures, and plant growth status (rapid growth vs. senescence). Most studies to determine the rates of plant-mediated oxygen transfer have been performed in laboratory microcosms or mesocosms under controlled conditions. (George et al., 2000, Liehr, et al., 2000) It is not clear if these results are transferable to full-scale systems.

Based on a review of the literature, the likely rate of oxygen transfer is between zero and $3.0 \text{ g-O}_2/\text{m}^2\text{-d}$ ($0 - 0.6 \text{ lbs}/1000 \text{ ft}^2\text{-d}$). While this maximum value is within the BOD loading range of lightly loaded VSB systems, ($3 \text{ g}/\text{m}^2\text{-d} = 30 \text{ kgBOD}/\text{ha-d} = 27 \text{ lb BOD}/\text{ac-d}$), there is very little evidence to support the assumption that plants add significant amounts of oxygen to VSB systems. Typical values of dissolved oxygen in VSB systems are very low ($<1.0 \text{ mg}/\text{L}$), but because of the difficulty in obtaining an accurate in-situ oxygen reading, the actual values are probably even lower. In VSB systems where oxidation-reduction potential (ORP) has been measured, values were typically quite negative, indicating strong reducing conditions.

Unplanted systems have been found to perform as well as planted systems in both BOD and ammonia nitrogen removal (George et al., 2000, Liehr et al., 2000, Young, et al., 2000). Furthermore, investigations of root depth and flow pathways have found that the roots do not fully penetrate to the bottom of the media and there is substantially more flow under the root zone than through it (Young et al., 2000, George et al., 2000, Bavor et al. 1989, Fisher, 1990, DeShon et al., 1995, Sanford et al., 1995a & 1995b, Sanford, 1999, Rash and Liehr, 1999, Breen and Chick, 1995, Bowmer, 1987). The oxygen supply from the roots is also likely to be unreliable due to yearly plant senescence, plant die-off due to disease and pests, and variable plant coverage from year to year. Considering all of these factors, it is recommended that designers assume wetland plants provide no significant amounts of oxygen to a VSB system.

Plants will also affect the other potential source of oxygen to VSBs — the direct oxygen transfer from the atmosphere to the wastewater. Researchers at TVA have estimated oxygen transfer from the atmosphere to be between 0.50 and $1.0 \text{ g-O}_2/\text{m}^2\text{-d}$ ($0.1 - 0.2 \text{ lbs}/1000 \text{ ft}^2\text{-d}$) (Behrends et al., 1993). Decomposing plant matter on top of the media would likely cause even lower rates of oxygen transport into the wastewater because the plant matter acts as a diffusion barrier and, ultimately, an oxygen demand.

5.2.1.3 Nutrient and Metals Removal by Wetland Plants

Wetland plants take up macro-nutrients (such as N and P) and micro-nutrients (including metals) through their roots during active plant growth. At the beginning of plant senescence most of the nutrients are translocated to the rhizomes and roots. A significant proportion of the nutrients may also be exuded from the plant (Gearheart et al., 1999). Estimates of net annual nitrogen and phosphorus uptake by emergent wetland species vary from 12 to $120 \text{ gN}/\text{m}^2\text{-y}$ and 1.8 to $18 \text{ gP}/\text{m}^2\text{-y}$ respectively (Reddy and DeBusk, 1985). Reeds and bulrush are at the lower end of both ranges while cattails are at the higher end. These estimates are based on annual growth rates and nutrient concentrations of the whole plant, but since in a VSB system only the shoots can be harvested, the values should be reduced by at least 50%. Plant uptake of metals can also be estimated by this method. To maximize nutrient removal by the plants in a VSB system, shoot harvesting must be done before senescence. Harvesting of wetland plants is not recommended during the growing season because the warm temperatures may cause plant stress, substantial stem death, and significant delay in re-growth in some wetland plants (George, et al., 2000).

The expected maximum removal rates of nitrogen, phosphorus and metals by direct plant uptake and harvesting are small compared to typical loadings in VSB systems. Furthermore, nitrogen, phosphorus and metals removal by plant uptake will vary with time. Most of the nutrient uptake occurs during rapid plant growth in the spring and summer, and if the plant is not harvested before senes-

cence a significant portion of the plant-sequestered nutrients are released back into the water. Therefore, unless the nutrient removal standards for a VSB system are also variable and synchronous with plant uptake and release, the presence of plants may be more harmful than helpful in meeting nutrient removal standards. Finally, it is unlikely that the nutrients or metals removal obtained by harvesting are worth the considerable time and labor required to harvest and reuse or dispose of the biomass.

5.2.1.4 Plant-Supplied Carbon Sources for Denitrification

Because of the inherent anaerobic conditions associated with VSB systems, they are good candidates for denitrification. The likely limiting factor for denitrification in VSB systems is biodegradable organic carbon. The value of plant-supplied organic carbon for denitrification in a VSB system depends on the wastewater COD to nitrogen ratio and the forms of nitrogen in the influent to the system. Plant-supplied organic carbon is most important in VSB systems treating nitrate-rich influents deficient in biodegradable organic carbon such as effluents from nitrifying activated sludge plants. The minimum COD to nitrate-nitrogen ratio for denitrification is 2.3 g-COD/g-NO₃-N. Since oxygen is used preferentially over nitrate as the electron acceptor by the microbes that carry out denitrification, the required COD/NO₃-N ratio can be significantly higher if any oxygen is present in the system.

Decomposing wetland plants and plant root exudates are potential sources of biodegradable organic carbon for denitrification but are also sources of organic nitrogen, which is easily converted to ammonia. Plant root exudates of organic carbon and nitrogen are the largest at the beginning of senescence. Because of the predominantly anaerobic conditions in VSB systems, decomposition of plant biomass within the media of a VSB system will likely provide more organic carbon (and ammonia) to the wastewater than will decomposition of the plant biomass on top of the media, which takes place in largely aerobic conditions. Some of the decomposition products of biomass on top of the media (including nitrates) are transported into the wastewater by precipitation infiltration.

In one study of a VSB system treating a nitrified secondary effluent, nitrate removal improved from 30% to 80% when mulched biomass including straw, wetland plants, and grass was applied to the top of the media (Gersberg et al., 1983). Another study with a VSB system treating a nitrified landfill leachate found that nitrate removal was limited by biodegradable organic carbon (Liehr et al., 2000).

5.2.1.5 Plant Role in Thermal Insulation

One potential advantage of a planted over an unplanted VSB system is the role of plants in providing thermal insulation to the wastewater during cold weather. Dead plant biomass on top of the media helps to limit both convective heat losses from the wastewater and infiltration of melted snow into the wastewater. Two researchers have developed methods to estimate the effect of plants in prevent-

ing heat loss from the wastewater of a VSB system (Reed et al., 1995, Smith et al., 1997). However, it is not clear how important this factor is in pollutant removal performance because 1) it has not been shown that planted VSB systems perform better than unplanted systems, even in winter, and 2) the dead plant material on top of the media also acts as a barrier to oxygen transfer and a potential source of biodegradable carbon and nutrients to the wastewater.

5.2.1.6 Plant Impact on Hydraulic Conductivity (Clogging) and Detention Time

Several VSB systems have experienced conditions called "surfacing" where a portion of the wastewater flows on top of the media. Surfacing (1) creates conditions favorable for odors and mosquito breeding, (2) creates a potential health hazard for persons and animals that may come into contact with the wastewater, and (3) reduces the hydraulic retention time (HRT) and performance of a VSB system. Surfacing occurs whenever the hydraulic conductivity of the media is not sufficient to transport the desired flow within the usable headloss of the media. The usable headloss is defined by the difference in the elevations of the outlet piping and the top of the media. Surfacing can result from a number of factors including (1) poor design of the system inlet and outlet piping, (2) an inaccurate estimate of the clean hydraulic conductivity of the media, (3) improper construction, and (4) an inaccurate estimate of the reduction in hydraulic conductivity, or "clogging", that will occur due to solids accumulation and/or growth of plant roots. Several researchers have found that clogging was the most severe within the first 1/4 to 1/3 of the system (Young et al., 2000, George et al., 2000, Bavor et al. 1989, Fisher, 1990, Sapkota and Bavor, 1994, Tanner and Sukias, 1995, Tanner et al., 1998). The hydraulic conductivity was found to be less restricted and fairly uniform over the remaining length of the system.

Based on studies in Europe during the 1980s, some researchers proposed that plant roots significantly increased the hydraulic conductivity in VSBs with soil media by opening up preferential pathways for the wastewater flow (Kickuth, 1981). Later studies of these systems found that a significant portion of flow occurred on top of the soil (Cooper et al., 1989). Based on recent studies, the presence of plant roots in the gravel media of a VSB system will have a negative effect on hydraulic conductivity (George et al., 2000, Young et al., 2000, DeShon et al., 1995, Sanford et al., 1995a and 1995b, Breen and Chick, 1995). Researchers at TTU compared the reduction in void volume due to root and non-root solids. They estimated that the reduction in void volume due to root solids (2 - 8%) was much larger than the reduction in void volume due to non-root solids (0.1 - 0.4%). Even though the overall estimated reduction in void volume was small, there was a 98% reduction in hydraulic conductivity.

The primary functions of a plant's roots are to supply water and nutrients and to physically anchor or support the above-ground portions on the plants. Water and nutri-

ents will be plentiful at all depths of a VSB, so the plant roots will typically penetrate only 15 - 25 cm (6" - 10") as needed to anchor the plant. In most VSB systems the plant roots do not fully penetrate the entire depth of the media and the reduction in hydraulic conductivity in the root zone results in the creation of "short-circuiting" under the root zone, and more flow through the portion of the media without roots (Bavor et al., 1989, Fisher, 1990, DeShon et al., 1995, Sanford et al., 1995a and 1995b, Sanford, 1999, Rash and Liehr, 1999, Tanner and Sukias, 1995, Breen and Chick, 1995). This situation may also lead to the creation of stagnant zones within the media ("dead volume") which results in lower actual HRTs as the water preferentially flows through a smaller volume of the media. The decrease in HRT will depend in part on the fraction of the depth that is occupied by the roots; that is, deeper beds will have more a greater proportion of the media that is not impacted by roots.

From tracer studies, researchers have found significant differences between actual and theoretical HRTs in their VSB systems and attributed it to dead volume in the upper zone of the media where the majority of the roots grow (Liehr et al., 2000, Young et al., 2000, Bavor et al., 1989, Fisher, 1990, DeShon et al., 1995, Sanford et al., 1995a and 1995b, Breen and Chick, 1995). However, the researchers at TTU did not find a significant reduction in HRT in three of the cells they studied. (George et al., 2000)

The researchers at North Carolina State University (NCSU) attributed part of the dead volume in their systems to stratification of the water caused by less dense rain water infiltration ponding within the media on top of higher density leachate. This phenomenon has also been reported by others (DeShon et al., 1995, Sanford et al., 1995a and 1995b, Sanford, 1999, Rash and Liehr, 1999). NCSU found that the short-circuiting was greater in an unplanted VSB system than in a planted system. While rain water ponding may be a problem with some VSB systems, the effect at NCSU was magnified by the relatively large catchment area (due to the shallow side slopes used in the system) and the salinity of the leachate. The CU researchers performed two sets of tracer studies in the three cells of the Minoa system. The first set was performed in the clean media of each cell before planting. The second set was performed after plant establishment on the one cell that was half planted and half unplanted. From the first study they concluded that there was short circuiting through the lower media and dead volume resulting in the actual HRTs being only 75% of the theoretical values, even in the clean media. They attributed these results to media compaction during construction and intermixing of the upper pea gravel with the lower larger media. From the second tracer study they concluded that plants roots, which penetrated only half of the media depth, resulted in more short circuiting and dead volume than in the unplanted media. Tanner & Sukias (1995) also reported more accumulation of solids in the root zone, which further contributed to preferential flow around the root zone.

5.2.2 Removal Mechanisms

5.2.2.1 BOD and TSS

VSB systems have been used for secondary treatment (i.e. 30 mg/L of BOD and TSS) for a variety of wastewaters including: primary and septic tank effluents; pond effluent; and effluents from activated sludge, RBC, and trickling filter systems that don't consistently meet secondary standards. As discussed in Chapter 3, the primary mechanisms for BOD and TSS removal are flocculation, settling, and filtration of suspended and large colloidal particles. VSB systems are effective for TSS and BOD because of relatively low flow velocities and a high amount of media surface area. They typically do better at TSS removal, because TSS removal is a completely physical mechanism, while BOD removal is more complex. Larger biodegradable particles that have been quickly removed by physical mechanisms will be degraded over time and be converted into particles in the soluble and small colloidal size range. As such they become an internal "source" of BOD as they degrade and reenter the water. Some material is also incorporated into microbial biomass.

Some material will accumulate in a VSB, but the amount of long term solids accumulation is unknown. Tanner and Sukias (1995) reported finding less solids accumulation than would be expected based on the load in the influent wastewater. Researchers at Richmond, Australia (Bavor et al., 1989, Fisher, 1990) found that most solids were removed in the initial section of the VSB and that the "solids accumulation front" stabilized after a year and did not advance. These findings support the idea that trapped material will degrade over time. VSB systems treating pond wastewater are likely to accumulate more solids, and be more susceptible to clogging, because TSS in pond wastewater is predominantly algae, which are slightly less biodegradable and degrade more slowly than typical primary or secondary wastewater solids.

BOD and TSS in the effluent from a VSB are probably not materials that have passed through the VSB, but rather are converted or internally produced material. As such it is likely to be quite different in size or composition from influent BOD and TSS. For example, the influent TSS in the Las Amimas system were predominantly algal cells, but there were almost no algal cells in the effluent even though the effluent TSS averaged 30 mg/L (Richard & Synder, 1994).

True BOD removal only occurs when the material causing the BOD is completely converted by anaerobic biological processes to gaseous end products. The two most likely anaerobic pathways are methane fermentation and sulfate reduction. Because methane fermentation is severely inhibited at temperatures below 10°C, sulfate reduction probably predominates for soluble BOD removal during colder months. However, seasonal performance does not vary as much as would be expected based on the typical temperature dependence of biological reactions. A likely explanation, illustrated in Figure 5-1, is that biodegradable particles that are physically removed during colder months

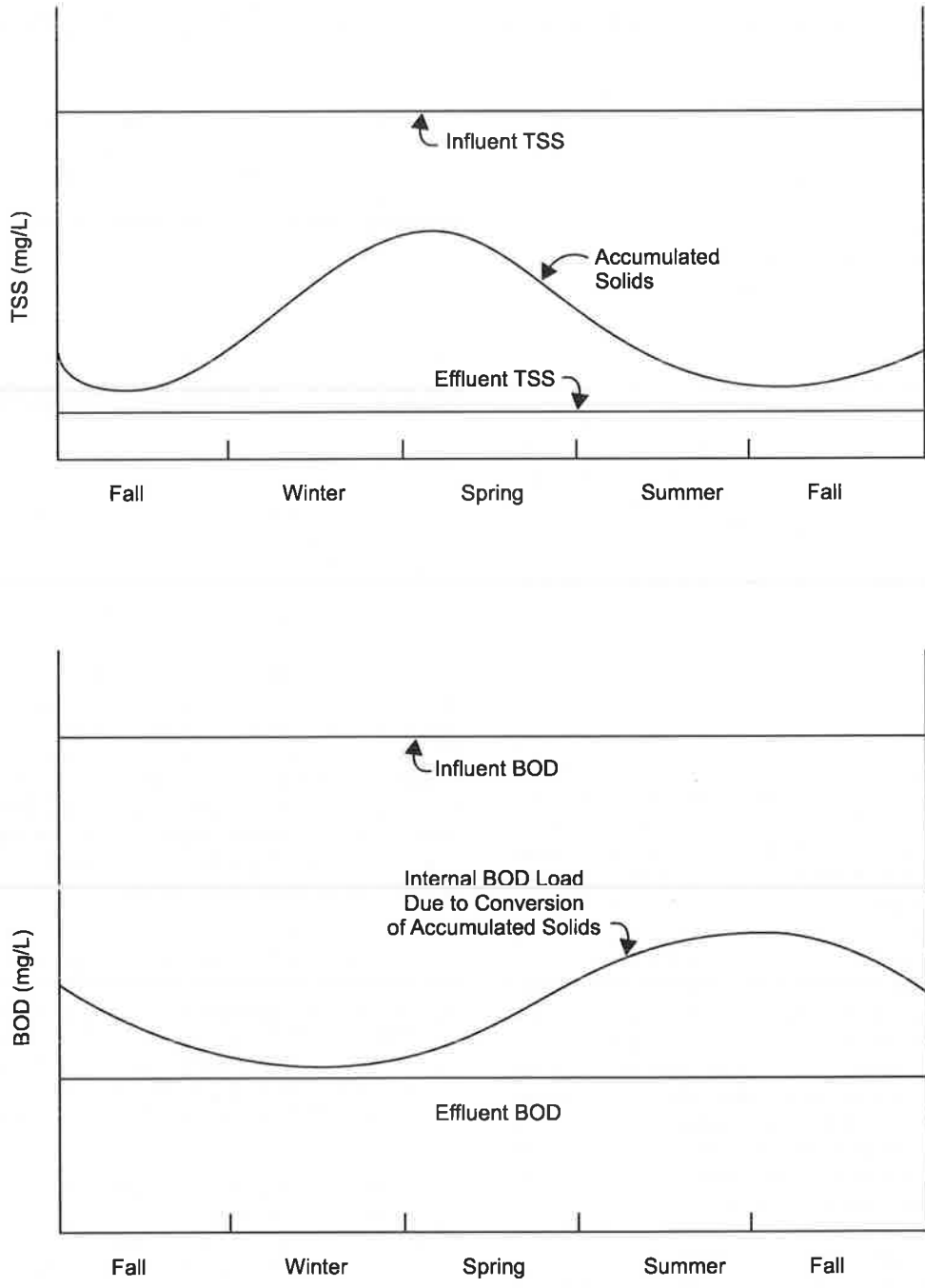


Figure 5-1. Seasonal cycle in a VSB

are degraded more slowly and accumulate (Kadlec and Knight, 1996). As the temperature warms up the rate of degradation of trapped particles increases, leading to a reduction of accumulated solids and a release of BOD. This theory would explain why summer BOD removal rates, based on influent BOD loading, do not appear to be significantly greater than winter removal rates. The need for insulation of the surface of VSB systems in northern climates has been discussed, but the need has not been quantified (Jenssen, et al, 1993).

Alternative VSB systems should achieve higher oxygen transfer rates, so BOD removal should improve because aerobic biological processes will become more prevalent. However, microbial biomass production should also increase, which may lead to increased clogging problems. The potential of alternative VSB systems for TSS and BOD removal is unclear, but performance at Minoa, NY has been very good (Reed and Giarrusso, 1999).

5.2.2.2. Nitrogen

Several conventional VSB systems have been designed, built and operated to remove ammonia from various wastewaters. While partial ammonia removal has been achieved in some systems, the removals have been less than predicted (George et al., 2000, Liehr et al., 2000, Young et al., 2000). Ammonia can be removed by microbial reactions or plant uptake. Because VSB systems are predominantly anaerobic, microbial removal via nitrification is very limited. As discussed in Section 5.2.1.3, plant uptake is also very limited. Very lightly loaded systems have achieved partial ammonia removal (George et al., 2000, 1999; Young et al., 2000), but if ammonia removal is required, a separate ammonia removal process should be used in conjunction with a VSB system.

The predominantly anaerobic condition of VSB systems seems well suited for microbial removal of nitrate via denitrification, but there are relatively few studies to document their use for this specific purpose (Gersberg, et al, 1983; Stengel and Schultz-Hock, 1989). Systems treating well oxidized secondary effluents or other carbon limited wastewaters may have inadequate carbon for denitrification to proceed efficiently (Liehr et al., 2000). Systems treating wastewaters with more carbon, and that have achieved partial nitrification, typically achieve almost complete denitrification (George et al., 2000, Young et al., 2000). Crites and Tchobanoglous (1998) suggest that significant denitrification of municipal wastewaters can occur in VSB systems at a detention time of 2 to 4 days, but Stengel and Schultz-Hock (1989) demonstrated with methanol addition that denitrification was carbon limited.

Alternative VSB systems should achieve higher oxygen transfer rates, so they should be more efficient at ammonia removal via nitrification (George et al., 2000, Reed & Giarrusso, 1999, Behrends et al., 1996, May et al., 1990) and less efficient for nitrate removal via denitrification than conventional VSBs.

5.3 Hydrology

5.3.1 Evapotranspiration and Precipitation Impacts

The avoidance of surfacing is a major design criterion and high amounts of precipitation or snowmelt can increase the flow in a VSB system. In climates with extended periods of precipitation or heavy snowmelt, the runoff from the total catchment area that drains into the VSB must be estimated and included in the design flow. Evapotranspiration (ET) decreases the hydraulic loading and will not contribute to surfacing.

Except in very wet climates, flows from precipitation events will probably not adversely affect performance because VSB systems have a relatively small surface area (compared to FWS wetlands) and effluent controls should be sufficient to prevent surfacing. Precipitation dilutes pollutants in the system, temporarily raises the water level, and decreases the HRT, while ET concentrates pollutants, temporarily lowers the water level, and increases the HRT. ET rates will vary depending on plant species and density, but rates from 1.5 to 2 times the pan evaporation rate have been reported in the literature (refs). Except in very wet or dry climates, the two results are probably offsetting, reducing the overall impact on water level and effluent values. Unfortunately, the specific effects of ET and precipitation on VSB performance are not documented because good estimates of ET and precipitation are hard to obtain, and precise influent and effluent flow measurements are seldom available, even in research systems.

5.3.2 Water Level Estimation

An important step in the design process is to estimate the elevation of the water surface throughout the VSB to ensure that surfacing of the wastewater does not occur. As in all gravity flow systems the water level in a VSB system is controlled by the outlet elevation and the hydraulic gradient, or slope, which is the drop in the water level (headloss) over the length from the inlet to the outlet. The relationship between flow through a porous media and the hydraulic gradient is typically described by the general form of Darcy's Law (Eq. 5.1). This form assumes laminar flow through media finer than coarse gravel, and many authors have modified it for other applications including other media and turbulent flow. However, use of the general form without modification is recommended as sufficient to estimate the water level within a VSB.

$$Q = (K)(A_c)(S) = (K)(W)(D_w)(dh/dL) \quad (5-1)$$

or, for a defined length of the VSB,

$$dh = (Q)(L) / (K)(W)(D_w) \quad (5-2)$$

where Q = flow rate, m³/d

K = hydraulic conductivity, m³/m²-d, or m/d

A_c = cross-sectional area normal to wastewater flow, m²
= (W)(D_w)

where W = width of VSB, m

D_w = water depth, m

- L = length of VSB, m
dh = head loss (change in water level) due to flow resistance, m
S = dh/dL = hydraulic gradient, m/m

The water level at the inlet of a VSB will rise to the level required to overcome the head loss in the entire VSB. Therefore, the VSB must be designed to prevent surfacing. K for an operating VSB varies with time and location within the media and will have a major impact on the head loss. K is very difficult to determine because it is influenced by factors that cannot be easily accounted for, including flow patterns (affected by preferential flow and short circuiting), and clogging (affected by changes in root growth/death and solids accumulation/degradation). Therefore, a value must be assumed for design purposes. Typical values for various sizes of rock and gravel are shown in Table 5-1. Several of the references listed in Table 5-1 also noted that K was much less in the initial 1/4 to 1/3 of the VBS than in the remainder of the bed. Based on the studies listed in Table 5-1 and many observed cases of surfacing in VSB systems, the following conservative values are recommended for the long-term operating K values:

- initial 30% of VSB K_i = 1% of clean K
final 70% of VSB K_f = 10% of clean K.

5.3.3 Hydraulic Retention Time and Contaminant Dispersion

The theoretical HRT in any reactor is defined as the liquid volume of the reactor divided by the flow rate through

it. The liquid volume in a VSB system is difficult to accurately determine because of the loss of pore volume to roots and other accumulated solids, such as recalcitrant biomass and chemical precipitates. The lost pore volume will vary with both location in the VSB and time, both seasonally and yearly, because of root growth and decay, and solids accumulation and degradation. Preferential flow (see section 5.2.1.6) as illustrated in Figure 5-2 will also have a direct impact on HRT and has not been correlated with changes in pore volume. For design purposes the volume occupied by roots and other solids is assumed to be insignificant and the theoretical HRT is estimated using the average flow (including precipitation and ET for very wet or dry climates) through the system, the system dimensions, the operating water level, and the initial (clean) porosity of the media, which is either estimated or experimentally determined.

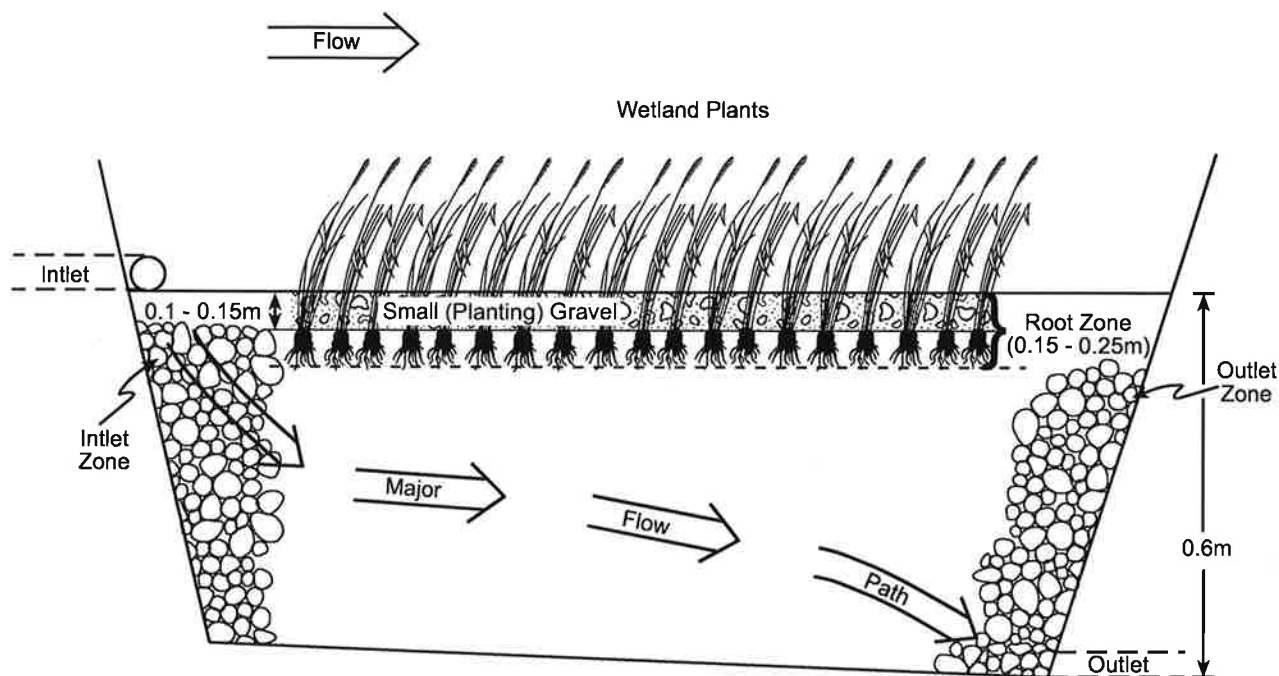
The actual HRT has been frequently reported to be 40-80% less than the theoretical HRT (based on pore volume) either due to loss of pore volume, dead volume, or preferential flow (Fisher, 1990, Sanford et al., 1995b, Bhattarai and Griffin, 1998, Batchelor and Loots, 1997, Rash and Liehr, 1999, Tanner and Sukias, 1995, Breen and Chick, 1995, Tanner et al., 1998, Bowmer, 1987). A rough approximation of the liquid volume can be determined by measuring the volume of water drained from an operating bed, but water held in small pores or adhering to biomass will remain in the system. Draining will also not be able to account for preferential flow. Tracer studies are recommended as a more realistic measure of the HRT in a VSB system, using one of a variety of tracers (Young et al., 2000, Young et al., 2000, George et al., 2000, Netter

Table 5-1. Hydraulic Conductivity Values Reported in the Literature.

Size and type ¹ of Media	"Clean"/"Dirty" K (m/d)	Type of Wastewater (Typical TSS, mg/L) ²	Length of Operation	Notes & References
5-10 mm gravel	34,000/12,000	2° effluent (100)	2 years	K = 12,000 is for downstream portion (last 80 m) of VSB K = 900 is for inlet zone (first 20 m) of VSB Bavor et al (1989), Fisher (1990), Bavor & Schulz (1993)
5-10 mm gravel	34,000/900	2° effluent (100)	2 years	
17 mm creek rock	100,000/44,000	nutrient solution (neg)	4 months	neg = negligible TSS Macmanus et al (1992), DeShon et al (1995)
6 mm pea gravel	21,000/9000	nutrient solution (neg)	4 months	
30-40 mm coarse gravel	NR/1000	2° effluent (30 w/a)	2 years	w/a = with algae; pond effluent; gravel bed only- no plants coarse gravel is first 6m of bed; fine is last 9 m of bed Sapkota & Bavor (1994)
5-14 mm fine gravel	NR/12,000	2° effluent (30 w/a)	2 years	
20-40 mm coarse gravel	NR/NR	landfill leachate (neg)	26 months	for coarse gravel, headloss was controlled by outlet, not K Sanford et al (1995a & 1995b), Sanford (1999), Surface et al (1993)
5 mm pea gravel	6200/600	landfill leachate (neg)	26 months	
19 mm rock	120,000/3000	septic tank effluent (50)	7 months	George et al (2000)
14 mm fine gravel	15,000/see note	aerated pond (60 w/a)	2 years	K of combined gravel (fine overlaid coarse) was 2000 at 50 m from inlet; 27,000 at 300 m from inlet Kadlec & Watson (1993), Watson et al (1990)
22 mm coarse gravel	64,000/see note	aerated pond (60 w/a)	2 years	

¹Type as defined in the reference(s)

²neg = negligible; w/a = with algae



Not to Scale & Dimensions Are "Typical"

Figure 5-2. Preferential Flow in a VSB

and Bischofsberger, 1990, Fisher, 1990, Netter 1994, Sanford et al., 1995b, Bhattarai and Griffin, 1998, Bowmer, 1987).

Some of the current design equations for VSB systems assume plug flow conditions. However, tracer studies performed on VSB systems have found significant amounts of dispersion as shown in Figure 5-3 (Sanford et al., 1995b, Bhattarai and Griffin, 1998, Liehr et al., 2000, George et al., 2000). Based on current data it appears that VSB systems can not be accurately modeled as either plug flow or complete mix reactors. The simplest model that can provide a reasonable fit to the tracer curves is a series of equal volume complete mix reactors. However, while this model may mathematically fit the tracer data, it does not realistically represent physical flow through porous media. Intuitively it would seem that a plug flow reactor with dispersion would most closely represent the actual conditions in a VSB. This model allows greater flexibility in determining a fit of the tracer data but typically results in a complex mathematical model of pollutant removal. Estimates of the dispersion number for VSB systems have ranged from 0.050 to 0.31 (George et al., 2000, Bhattarai and Griffin, 1998), with greater numbers for systems with small length-width ratios. Dispersion numbers less than 0.025 are indicative of near-plug flow conditions while values above 0.20 indicate a high degree of dispersion. The modeling of flow and dispersion is complicated by the non-uniformity

of flow and pore volume in space and time as previously discussed, and by other factors including precipitation and ET.

At this point in time there appears to be little justification for using complex flow models, because of a lack of data and the unpredictable and constantly varying conditions within a VSB.

5.4 Basis of Design

5.4.1 Introduction

Attempting to fully describe pollutant removal in VSB systems is at least as complex as trying to describe VSB hydraulics. Many authors have examined several relationships as a model for pollutant removal, including zero and first order reactions in both plug flow and complete mix reactor models. None of the relationships were found to reasonably fit of the all data that are available. Furthermore, data from VSB systems are typified by a wide variability, as would be expected of dynamic natural systems that are influenced by many factors. This variability is evident in the plots of TSS, BOD, TKN and TP data in this section. Data scatter is not reduced by comparing pollutant removal with a variety of factors (e.g. area, volume, HRT, percent removals or loading rate), or by normalizing the data (C_e/C_0). Expected trends, such as temperature dependence for BOD removal or better removal with lower

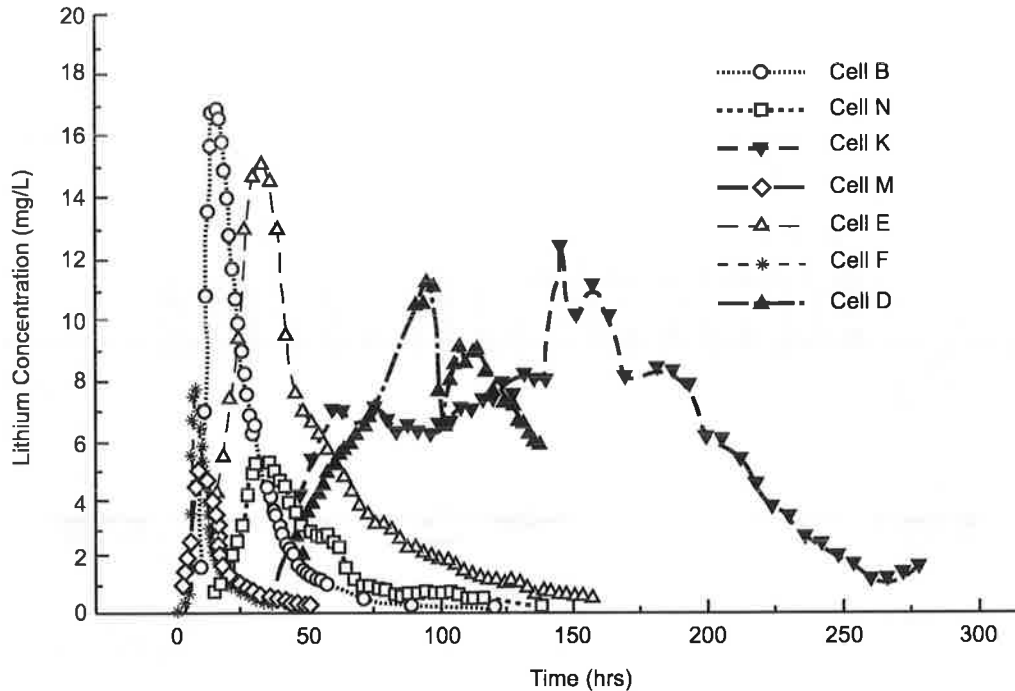


Figure 5-3. Lithium Chloride Tracer Studies in a VSB System (George et al., 2000)

pollutant loading, are often not apparent due to the scatter of the data. Therefore, the design approach recommended here is to use the maximum pollutant loading rates that have been shown to meet discharge standards. This approach yields a much more conservative design than other common design approaches. As additional quality data becomes available in the future, it may be possible to extend these conservative loading rates with confidence.

Two types of pollutant loading rates were considered, an areal loading rate (ALR), $\text{g/m}^2\text{-d}$, and a volumetric loading rate (VLR), $\text{g/m}^3\text{-d}$. Both ALRs and VLRs have been used by researchers to describe VSB performance. ALR is calculated by multiplying the influent flow rate (m^3/d) by the influent pollutant concentration ($\text{mg/L} = \text{g/m}^3$), and dividing by the surface area of the VSB system (m^2). Because sedimentation, plant growth and oxygen transfer are theoretically dependent on the surface area, ALR may be a characteristic parameter for some pollutants. VLR is calculated by multiplying the influent flow rate (m^3/d) by the influent pollutant concentration ($\text{mg/L} = \text{g/m}^3$), and dividing by the pore volume of the VSB system (m^3). Because the removal of certain pollutants could be dependent on the HRT, the VLR could be a characteristic parameter for some pollutants. However, because the actual saturated pore volume is seldom known and the HRT may not be directly related to the pore volume due to preferential flow, the utility of VLR for design purposes is limited. Also, a comparison of Figures 5-4 through 5-7, which are typical of scatter for all pollutants, shows that data scatter is not

reduced by the use of VLR. Therefore, the design recommendations in this chapter are based on ALRs.

Finally, because the type of pre-treatment has a major impact on the characteristics of the wastewater being treated, the following discussions are organized by the type of wastewater being treated: septic tank and primary effluents, pond effluents, and secondary treatment effluents.

5.4.2 TSS and BOD Removal for Septic Tank and Primary Effluents

Two recent studies, one conducted by Tennessee Technological University (TTU) and one conducted by Clarkson University (CU) at the Village of Minoa, New York, have provided the majority of data used to establish the design recommendations for this section (George et al., 2000, Young et al., 2000). These two studies were chosen because their research objectives were to provide design information, they utilized several VSBs with different measured loadings, and the data are of good quantity and quality. Influent in the TTU and CU studies were respectively a low strength septic tank effluent and a fairly typical primary effluent. Each data point in the following figures represents a quarterly average of biweekly (every 2 weeks) sampling for the TTU data, and a quarterly average of at least two monthly samples for the CU data. The results from one other VSB system treating septic tank effluent studied by University of Nebraska - Lincoln (UNL) researchers are also included in these figures (Vanier & Dahab, 1997). After reviewing the literature, no other studies with

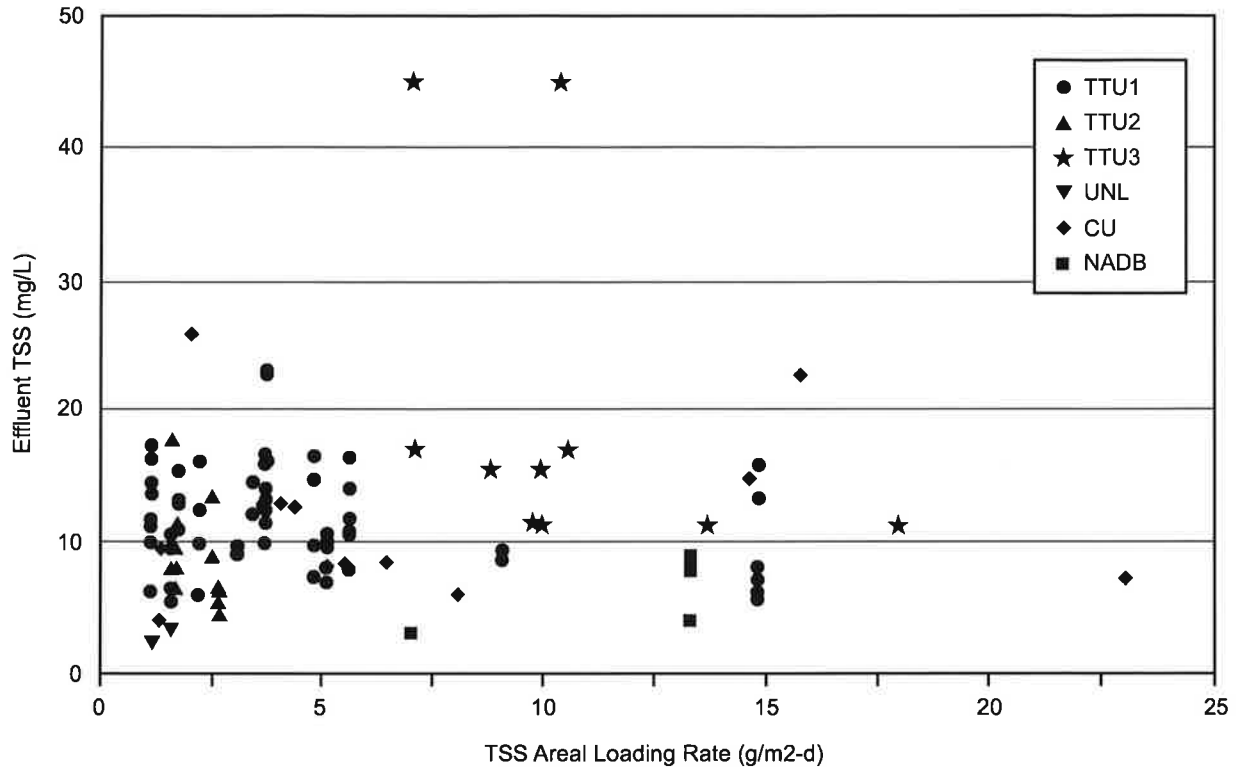


Figure 5-4. Effluent TSS vs areal loading rate

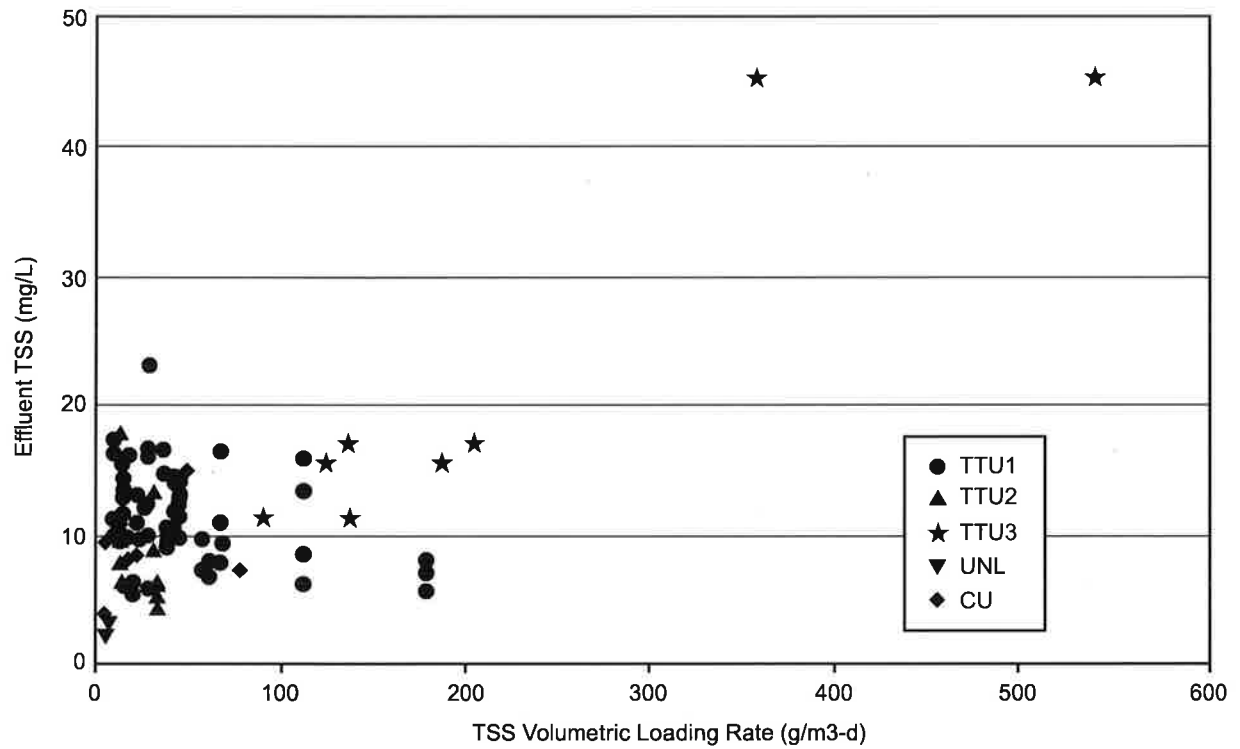


Figure 5-5. Effluent TSS vs volumetric loading rate

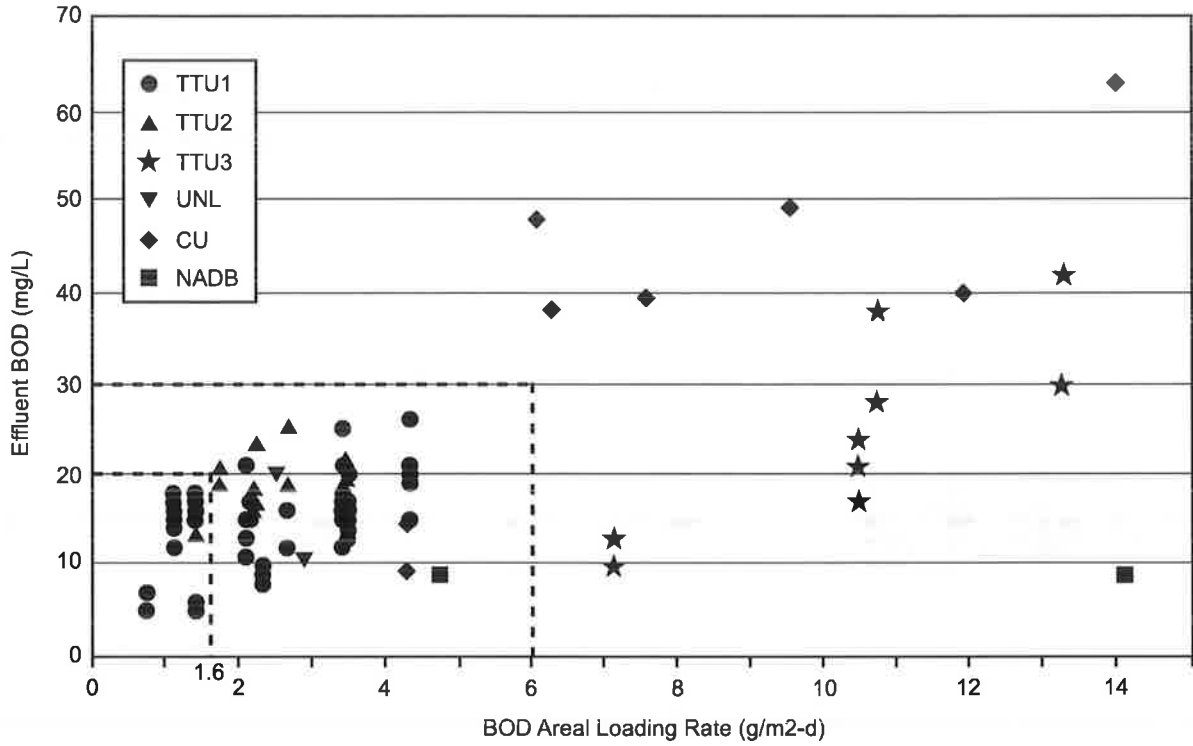


Figure 5-6. Effluent BOD vs areal loading rate

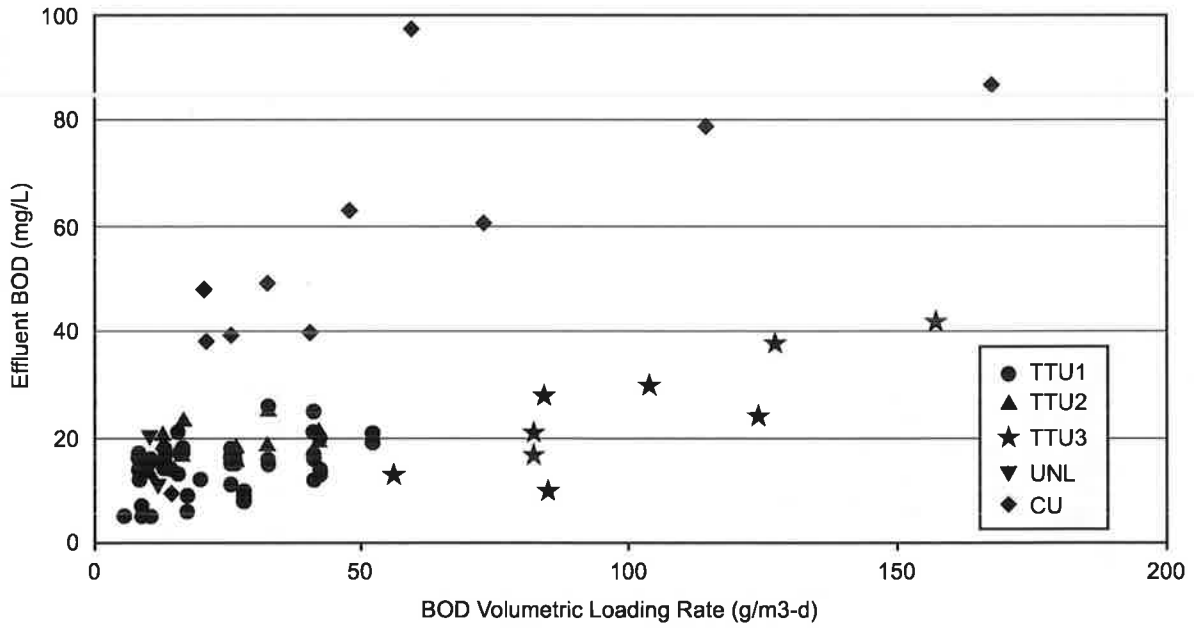


Figure 5-7. Effluent BOD vs volumetric loading rate

septic tank or primary wastewater were found to have data with similar quality and quantity as these three studies. Data from the NADB for VSBs treating primary effluent, some of which are of unknown quality, are also shown in Figures 5-4 and 5-6.

TSS removal is quite good; effluent TSS was consistently less than 30 mg/L at TSS ALRs as high as 20 g/m²-d (Figure 5-4). The two data points in Figure 5-4 that are above 30 mg/L are from systems at TTU that were intentionally overloaded to failure, and are not typical. Other researchers have reported plugging of the surface of the media (as opposed to clogging of the pore volume) when excessively high TSS loadings were applied (Tanner & Sukias, 1995, Tanner et al., 1998, van Oostrom & Cooper, 1990). Additional data may extend these limited ALRs when it becomes available. However, it should be noted that the typical sustained influent TSS concentrations for the data plotted in these figures were less than 100 mg/L. It is recommended that TSS ALR be limited to 20 g/m²-d, based on the maximum monthly influent TSS. This would correspond to a loading of 2 cm/d for an influent concentration of 100 mg/L of TSS, 4 cm/d for an influent concentration of 50 mg/L of TSS, and so on.

BOD removal is not as good as TSS removal, so the size of a VSB designed to meet secondary treatment standards will generally be controlled by the requirements for BOD removal. Effluent BOD values were found to periodically exceed 30 mg/L at BOD ALRs greater than 6 g/m²-d (Figure 5-6).

It is recommended that BOD ALR be limited to 6 g/m²-d, based on the maximum monthly influent BOD, to produce

a maximum effluent BOD of 30 mg/L. Table 5-2 compares the size of a VSB designed with this ALR compared to the size of VSBs designed using several common approaches. As expected the other design approaches result in VSB systems significantly smaller than that using the conservative design approach presented here.

5.4.3 Nutrient Removal for Septic Tank and Primary Effluents

Most of the organic nitrogen in septic tank and primary effluents is associated with suspended solids that are easily removed in VSB systems. It is generally assumed that the organic nitrogen will be converted to ammonia in VSB systems, but spiked concentrations of urea (a soluble form of organic nitrogen) were often not completely converted in one study (George et al., 2000). Ammonia removal in VSB systems is severely oxygen limited, and it is inversely related to the ultimate (carbonaceous and nitrogenous) BOD loading. Also, the conversion of organic nitrogen into ammonia via ammonification or hydrolysis masks any attempt to relate ammonia removal to other design factors. For this reason Total Kjeldahl Nitrogen (TKN) data rather than ammonia data are presented in Figure 5-8. The TKN removal performance is generally poor and highly variable. Therefore, VSB systems should not be used alone to treat pre-settled municipal wastewaters if significant amounts of ammonia must be consistently removed.

Although the data are not presented here, if any nitrate is produced in VSB systems treating septic tank and primary effluents, it is likely that the nitrate will be removed by denitrification.

Table 5-2. Comparison of VSB Area Required for BOD Removal Using Common Design Approaches.

Design criteria

Flow (Q) = 400 m³/d (105,680 gpd)

Influent BOD₅ (Ci) = 125 mg/L

Effluent BOD₅ (Ce) = 30 mg/L

Design Approach	Rate Constant	Loading Constant	Other Factors	Required Area m ² (ac)
This Manual		6 g/m ² -d (54 lb/ac-d)		8,330 (2.0)
European (Cooper, 1990)	K _{BOD} = 0.1/d			5710 (1.4)
Kadlec & Knight (1996)		180 m/yr (590 ft/yr)	Background Concentration ² = 10 mg/L	1420 (0.4)
Reed, etal. (1995)	Temperature Dependent ² K10 = 0.62/d K20 = 1.104/d		Water Depth ¹ = 0.4 m (16") Media Porosity ¹ = 0.38	at 10°C, 6090 (1.5) at 20°C, 3400 (0.8)
TVA (1993)		5.3 g/m ² -d (48 lb/ac-d)	Derived from TVA design Assumes septic tank effluent	9430 (2.3)

¹Values chosen by user; these are not necessarily the values recommended by the design's author.

²Values calculated per instructions of design's author.

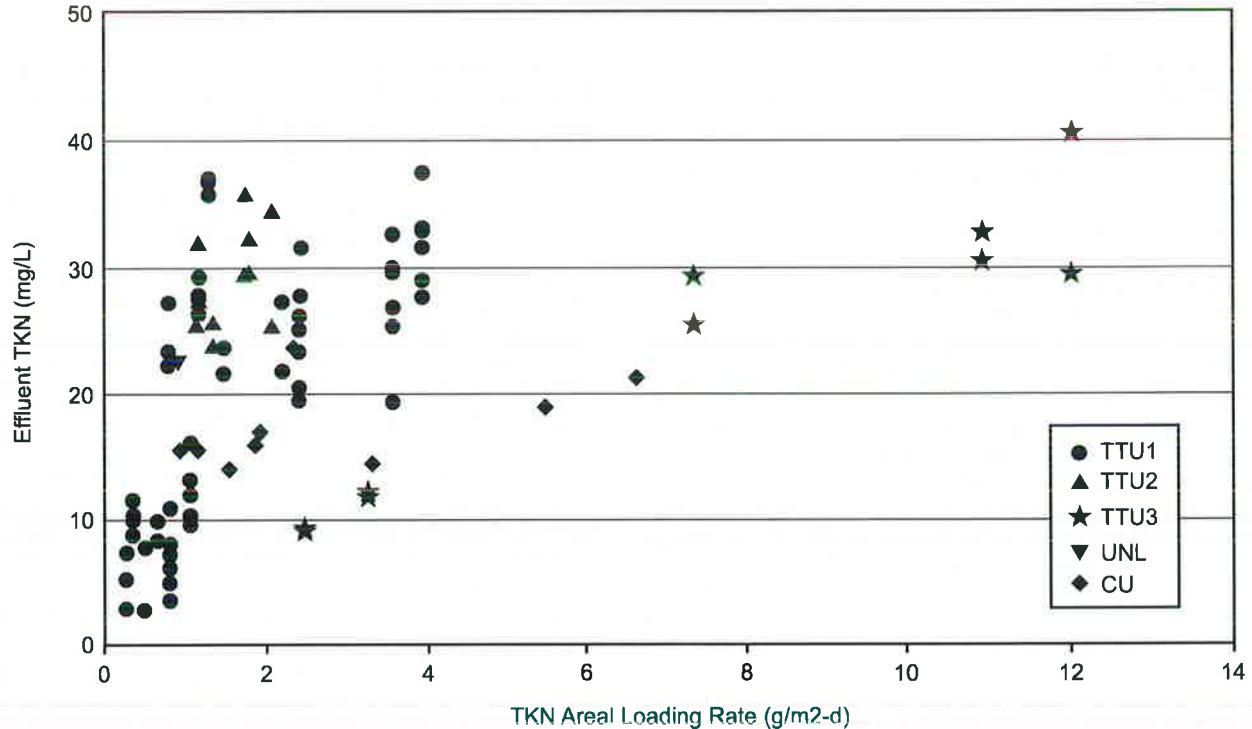


Figure 5-8. Effluent TKN vs areal loading rate

Although phosphorus is partially removed in VSB systems treating septic tank and primary effluents, VSBs are not very effective for long-term phosphorus removal (Figure 5-9). It should be noted that the phosphorus data shown in Figure 5-9 are from VSB systems that are relatively new, when it can be assumed that the phosphorus precipitation and adsorption capacity of the media would be at its greatest. Because plant uptake of phosphorus is quite small compared to typical loadings (Reed, et al, 1995; Crites & Tchobanoglous, 1998), the phosphorus removal capacity will decrease with time. Estimates of realistic long-term phosphorus removal by plant harvesting is limited to about 0.055 g/m²-d (0.5 lb/ac-d) (Crites & Tchobanoglous, 1998). VSB systems should not be expected to remove phosphorus on a long-term basis.

5.4.4 TSS, BOD and Nutrient Removal for Pond Effluents

There is much less quality data comparable to the TTU and CU studies for VSB systems treating pond effluents. Data from a study conducted at three experimental VSB systems at Las Animas, Colorado by Colorado State University (Richard & Synder, 1994) were used to support design recommendations for VSB systems treating pond effluents (Table 5-3). The pollutant removal performance for the Las Animas VSBs treating oxidized pond effluent was not as good as the performance of the TTU and CU systems. NABD data for VSBs treating pond effluent (Figure 5-10), which are not as reliable as the Las Animas

data, show similar performance. Several of the NABD systems have experienced surfacing caused by clogging of the media surface (as opposed to clogging of the pore volume) by algae.

For Las Animas, the average TSS ALR was 6.2 g/m²-d (55 lb/ac-d) and produced an overall average effluent TSS of 35 mg/L. The average BOD ALR was 2.0 g/m²-d (18 lb/ac-d) and produced an overall average effluent BOD of 25 mg/L. There was essentially no nitrogen or phosphorus removal on average in the three VSBs. The poor overall percent removal of BOD of 35% might be related to the relatively high concentrations of algal cells in the influent during several months of each year. The measured BOD of pond effluent typically does not account for the true BOD of algal cells because algal cells degrade more slowly than other organic matter.

A VSB system in Mesquite, Nevada has been used since 1992 in parallel with overland flow and oxidation ditch systems to treat an aerated pond effluent. One year of monthly data for the Mesquite system is summarized in Chapter 8. Over the one-year sampling period the effluent BOD averaged 29 mg/L when loaded at an average BOD ALR of 2.5 g/m²-d (22 lb/ac-d). Better BOD and TSS removals than at Las Animas and Mesquite are reported in a 1993 EPA report for several VSB systems treating pond algal effluents. However, the sparse amount of data of unproven quality represented by the average values given in the report is

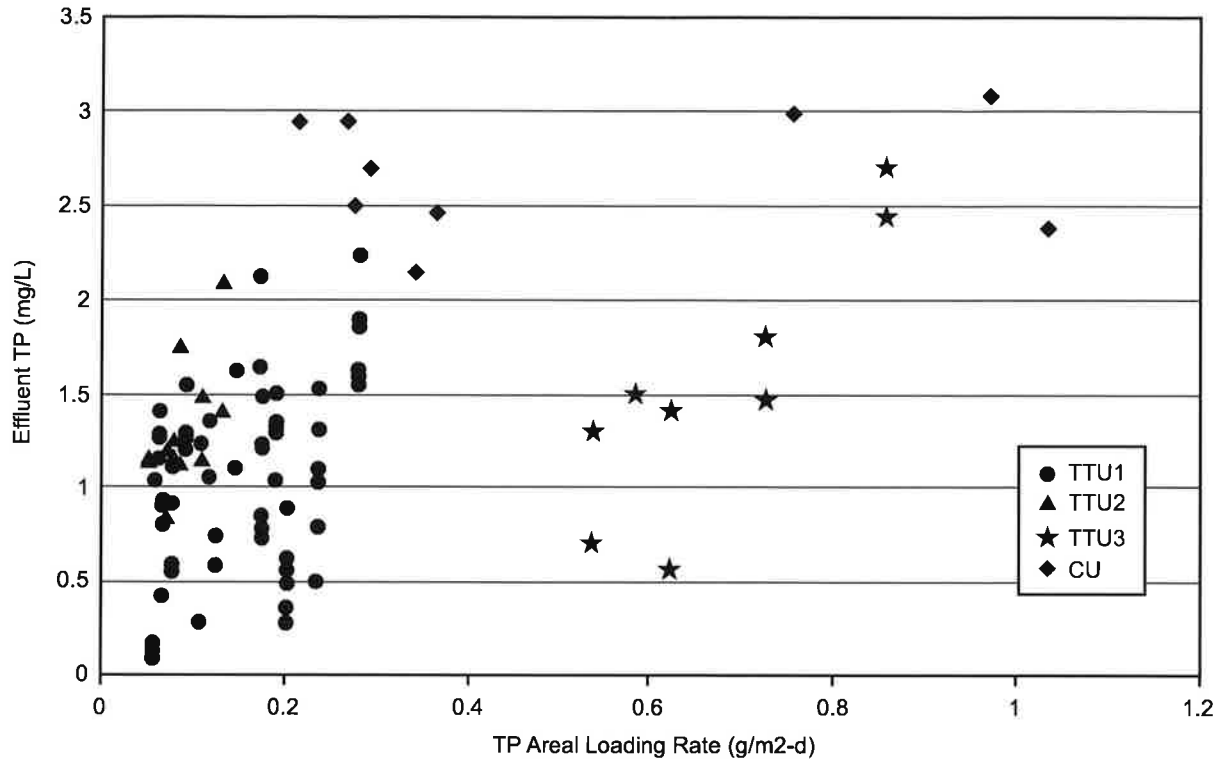


Figure 5-9. Effluent TP vs areal loading rate

inadequate to use with confidence. Sapkota and Bavor (1994) report similar TSS removal, but do not report BOD removal.

The upgrading of pond effluent with rock filters is similar to the use of VSBs after ponds. However, because of variable results from rock filters, their use is generally cautioned due to a lack of reliable design information (Reed, et al, 1995). Performance of rock filters is also plagued by H₂S generation and high effluent ammonia. Illinois requires effluent aeration and recommends disinfection before discharge for pond rock filter systems. Because of the limited data and uncertainty about similar rock filter systems, VSB systems are not recommended for treating pond effluents if the system must consistently meet a 30/30 standard.

5.4.5 BOD, TSS and Nutrient Removal for Secondary and Non-algal Pond Effluents

There are very few quality-assured data available from VSB systems in the U.S. treating secondary effluents. The 1993 U.S. EPA report included data collected over a three month period from three systems. Additional data from one of these systems, Mandeville, LA, is included in Chapter 8. The Mandeville VSB treats an aerated lagoon effluent which has little or no algae. The average influent BOD and TSS were 40 and 16 mg/L, respectively. The average effluent BOD and TSS were 5 and 3 mg/L, respectively at a BOD ALR of 7.9 g/m²-d (70 lb/ac-d).

Representatives from Severn Trent Water, Ltd., have reported on the performance of VSB ("reed bed") systems treating activated sludge and RBC effluents in small treatment plants (less than 2000 people) in the U.K. (Green and Upton, 1994). The goal for these VSB systems is to provide additional treatment of secondary effluents so that they consistently meet discharge limitations, which can vary from 30/20 to 15/10 TSS/BOD. Essentially these systems serve as aesthetic and sometimes economical substitutes for tertiary filters for small treatment plants. In some cases in the U.K. they have been used to treat storm water bypass flows at secondary treatment plants. While the Severn Trent systems typically remove some nitrogen and phosphorus, they are not capable of meeting typical discharge standards for nutrients in the U.S. The primary design basis used by Severn Trent is a hydraulic surface loading rate of 0.20 m³/m²-d (5 gpd/sq ft) for the average daily flow (Green and Upton, 1994). This value is derived from the design recommendation of the European task group on VSB systems (Cooper, 1990). For systems with an average influent BOD < 40 mg/L, this results in average areal BOD loading of less than 8.0 g/m²-d (71 lb/ac-d). Typical systems are 0.6 m (24 in) deep, 0.4 m wide per m³/d (5 ft per 1000 gpd) of flow, and 12.5 m (41 ft) long.

Based on the success of the Mandeville and Severn Trent systems, it appears that VSB systems can be effectively used to help small secondary systems consistently meet secondary effluent standards. The recommended approach

Table 5-3. Data from Las Animas, CO VSB Treating Pond Effluent.

Time Period ¹	Inf. TSS mg/L	Eff. TSS mg/L	Inf. BOD mg/L	Eff. BOD mg/L	Inf. TKN mg/L	Eff. TKN mg/L	Inf. TP mg/L	Eff. TP mg/L
Cell 1								
Winter 91	89.7	43.0	26.7	37.5	ND	ND	1.57	1.9
Srping 92	146.0	28.7	34.0	22.7	7.2	11.4	1	1.67
Summer 92	178.0	41.7	49.7	29.0	6.1	8.7	1.17	1.68
Fall 92	223.0	34.3	54.0	30.0	7.3	10.7	1.47	1.9
Winter 92	50.0	34.3	33.7	32.7	14.1	14.0	2.25	2.3
Spring 93	66.0	24.0	41.0	32.0	16.1	16.3	2.55	2.6
Summer 93	95.3	33.3	30.0	9.3	3.9	5.3	0.67	0.78
Fall 93	127.0	38.0	40.3	16.0	4.0	3.4	0.65	0.6
Average	121.9	34.7	38.7	26.2	8.4	10.0	1.42	1.68
Cell 2								
Winter 91	89.7	51.0	26.7	37.0	ND	ND	1.57	2.57
Srping 92	146.0	34.0	34.0	35.0	7.2	14.1	1	2.37
Summer 92	178.0	43.3	49.7	29.3	6.1	9.0	1.17	1.72
Fall 92	223.0	26.0	54.0	40.0	7.3	8.8	1.47	1.78
Winter 92	50.0	33.0	33.7	29.7	14.1	14.2	2.25	2.28
Spring 93	66.0	26.7	41.0	35.3	16.1	15.2	2.55	2.68
Summer 93	95.3	27.0	30.0	15.0	3.9	5.5	0.67	0.82
Fall 93	127.0	33.3	40.3	21.3	4.0	4.8	0.65	0.65
Average	121.9	34.3	38.7	30.3	8.4	10.2	1.42	1.86
Cell 3								
Winter 91	89.7	46.0	26.7	11.3	ND	ND	1.57	1.47
Srping 92	146.0	47.0	34.0	22.0	7.2	5.4	1	1.43
Summer 92	178.0	33.3	49.7	20.3	6.1	9.6	1.17	1.62
Fall 92	223.0	41.3	54.0	27.0	7.3	8.1	1.47	1.72
Winter 92	50.0	34.3	33.7	25.7	14.1	13.0	2.25	2.2
Spring 93	66.0	23.7	41.0	29.7	16.1	13.9	2.55	2.53
Summer 93	95.3	29.3	30.0	8.3	3.9	4.7	0.67	0.82
Fall 93	127.0	34.3	40.3	8.0	4.0	5.6	0.65	0.55
Average	121.9	36.2	38.7	19.0	8.4	8.6	1.42	1.54

¹Each of the values in the table is the average of three monthly samples.

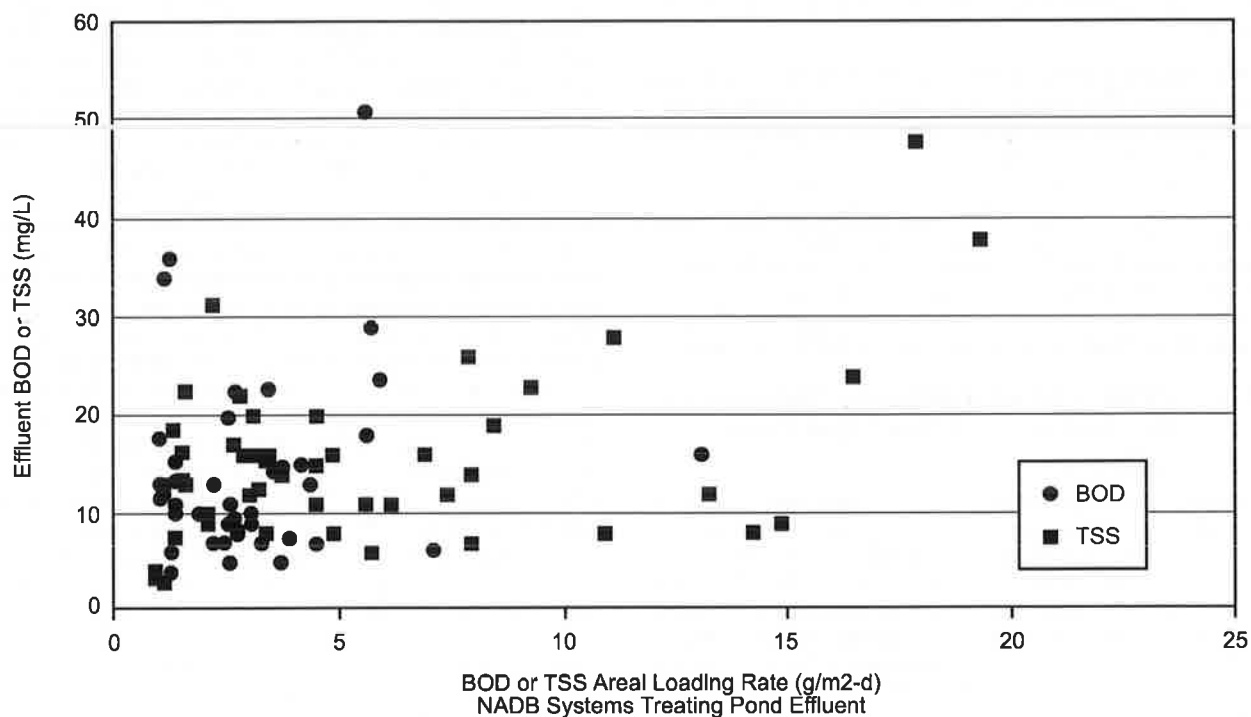


Figure 5-10. NADB VSBs Treating Pond Effluent

is to limit the BOD ALR to a maximum monthly value of 8 g/m²-d (71 lb/ac-d). However, VSB systems are not recommended as a remedy for inadequately operated activated sludge systems. Process upsets in poorly operated activated sludge systems can quickly fill a VSB system with mixed liquor solids, resulting in surface flow due to clogging of the media.

5.4.6 Metals Removal for All Types of Wastewater

Metals are removed in a VSB by two primary mechanisms. First, because many metals (e.g. Zn, Cr, Pb, Cd, Fe, Al) are associated with particles (Heukelekian & Balmat, 1959; SWEP, 1985), the high efficiency of particulate separation in a VSB should remove these metals accordingly. Second, sulfide precipitation occurs due to the reduction of sulfates to sulfides in the absence of nitrate, and renders some metals insoluble, resulting in significant removals, as described in Reed, et al (1995) for Cu, Cd, and Zn. As long as the system ORP remains low, which is likely given the anaerobic nature of VSBs, it is unlikely that metals precipitated in the sulfide form will re-enter the water column (Bounds, et al, 1998; Reed, et al, 1995). Some metals such as Ni and Cd are more mobile and less likely to be removed, but they are not normally present in toxic quantities in municipal wastewater.

There is relatively little data on metals removal by VSB systems and no known information from long-term studies. Gersberg et al. (1984) found significant removal of Cu, Zn and Cd, and determined that plant uptake was responsible for only 1% of the Cu and Zn removal. In a study with a VSB system treating a landfill leachate, researchers found only a small increase in the Pb, Cd, and Cu levels on root surfaces, and no increase in any of the metals measured in any plant tissue compared to plants from a control system (Pevery et al., 1995). They concluded that the increased metal concentrations on the root surface was due to metal precipitation and adsorption. Metal removal by plant uptake should not be counted on in any VSB system over the long term.

5.4.7 Pathogen Removal for All Types of Wastewater

While pathogens will be partially removed in a VSB system, a disinfection step after the VSB will normally be required to meet discharge limits. Researchers in Nebraska found a three log reduction in fecal coliforms from 10⁶ to 10³/100mL in a VSB system treating a septic tank effluent (Vanier and Dahab, 1997). Gersberg et al. (1989) found a two log reduction in total coliforms in a VSB system treating primary effluent. The coliform removal in two VSB systems in England treating secondary effluents varied between 40% and 99%, but effluent values did not meet discharge requirements (Griffin et al., 1998). Fecal coliform reductions were typically two logs (1 x 10⁶ to 1 x 10⁴/100mL) in several experimental VSB systems in Tennessee, except for two cells operated in a fill and drain mode. These fill and drain cells achieved a three log reduction with the

same influent wastewater (George et al., 2000). For design purposes a two log reduction is a reasonable estimate of VSB performance.

5.5 Design Considerations

5.5.1 Media Size and Hardness

The media of a VSB system perform several functions; they (1) are rooting material for vegetation, (2) help to evenly distribute/collect flow at the inlet/outlet, (3) provide surface area for microbial growth, and (4) filter and trap particles. For successful plant establishment, the uppermost layer of media should be conducive to root growth. A variety of media sizes and materials have been tried, but there is no clear evidence that points to a single size or type of media, except that the media should be large enough that it will not settle into the void spaces of the underlying layer. It is recommended that the planting media not exceed 20 mm (3/4 in) in diameter, and the minimum depth should be 100 mm (4 in).

The media in the inlet and outlet zones (see Figure 5-11) should be between 40 and 80 mm (1.5 – 3 in) in diameter to minimize clogging and should extend from the top to the bottom of the system. The inlet zone should be about 2 m long and the outlet zone should be about 1 m long. These zones with larger media will help to even distribute or collect the flow without clogging. The use of gabions (wire rock baskets used for bank stabilization) to contain the larger media simplifies construction. Gabions may also make it easier to remove and clean the inlet zone media if it becomes clogged.

Any portion of the media that is wetted is a surface on which microbes grow and solids settle and/or accumulate. Media in VSBs have ranged from soil to 100 mm (4 in.) rock. Experience with soil and sand media shows that it is very susceptible to clogging and surfacing of flows, even if influent TSS concentrations are minimal, so soil or sand media should be avoided. Gravel and rock media have been used successfully, with smaller diameter media being more susceptible to clogging, and larger media more difficult to handle during construction or maintenance. Crushed limestone can be used, but is not recommended for VSB systems because of the potential for media breakup and dissolution under the strongly reducing environment of a VSB, which can lead to clogging. Media with high iron or aluminum will have more sites for phosphorus binding and should enhance phosphorus removal, but only during the first few months of operation. The limited removal capability is probably not worth an added expense if it is not available locally at a reasonable cost. Alternative media such as shredded tires, plastic trickling filter media, expanded clay aggregates and shale with potentially high phosphorus absorptive capacity have been used, but there is inadequate data to make a recommendation for or against their use.

There does not appear to be a clear advantage in pollutant removal with different sized media in the 10 to 60 mm (3/8 - 2 in.) range. Therefore, it is recommended that the

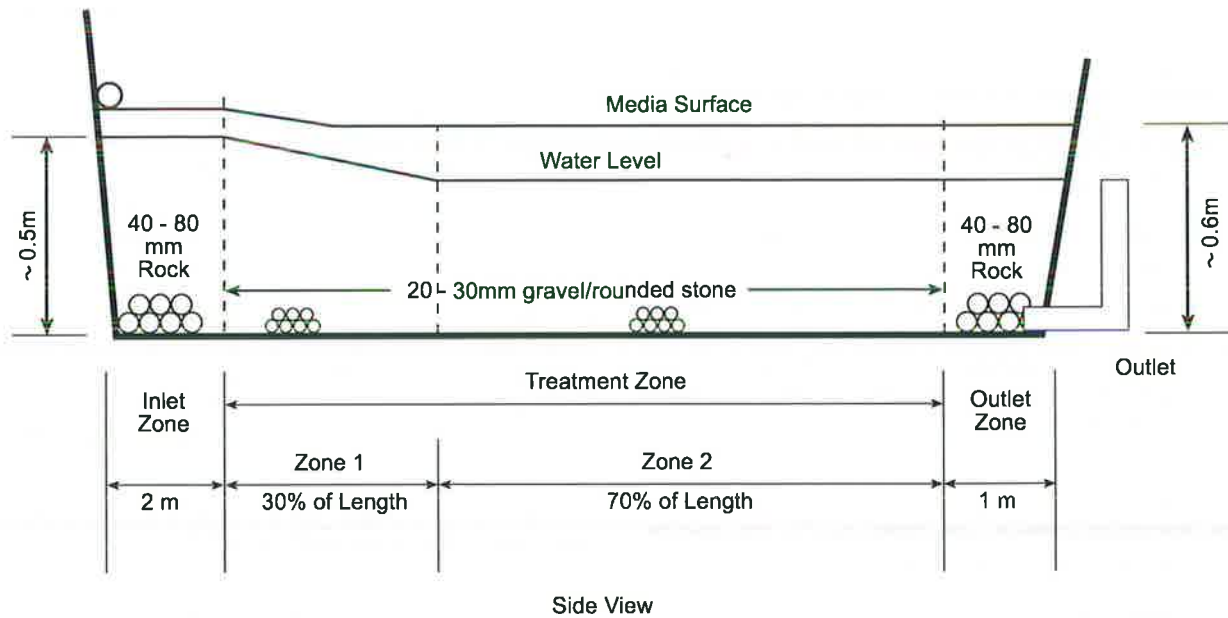


Figure 5-11. Proposed Zones in a VSB

average diameter of the treatment zone media be between 20 and 30 mm (3/4 – 1 in.) in diameter as a compromise between the potential for clogging and ease of handling. To minimize settling of the media smooth, rounded media with a Mohs hardness of 3 or higher is recommended if it is available locally at a reasonable cost. Based on the data in Table 5-1, the hydraulic conductivity of the 20 - 30 mm diameter clean media is assumed to be 100,000 m/d.

5.5.2 Slopes

The top surface of the media should be level or nearly level for easier planting and routine maintenance. Theoretically, the bottom slope should match the slope of the water level to maintain a uniform water depth throughout the VSB. However, because the hydraulic conductivity of the media varies with time and location, it is not practical to determine the bottom slope this way, and the bottom slope should be designed only for draining the system, and not to supplement the hydraulic conductivity of the VSB. A practical approach is to uniformly slope the bottom along the direction of flow from inlet to outlet to allow for easy draining when maintenance is required. No research has been done to determine an optimum slope, but a slope of 1/2 to 1% is recommended for ease of construction and proper draining (Chalk & Wheale, 1989). Care should be taken when grading the bottom slope to eliminate low spots, channels and side-to-side sloping which will promote dead volume or short-circuiting.

The slope of the berms containing a VSB should be as steep as possible, consistent with the soils, construction methods and materials. Shallow side slopes create larger areas which capture and route precipitation into the VSB,

which may be detrimental to system performance. Also, the site should be graded to keep off-site runoff out of the VSB.

5.5.3 Inlet and Outlet Piping

The inlet piping must be designed to minimize the potential for short-circuiting and clogging in the media, and maximize even flow distribution. For VSBs with length-width ratios less than one, additional care must be taken to spread the influent across the whole width of the VSB. Standard hydraulic design principles and structures (e.g. adjustable weirs and orifices) are used to split, balance evenly distribute flows (WEF, 1998). The recommended method to evenly distribute flows is to use reducing tees or 90 degree elbows which can be rotated on the header (see Chapter 6). The main advantage of a rotating fitting is that it allows the operator to easily adjust the distribution of the influent, which may help in reducing media clogging. When the potential for public access exists, a cover over the influent distribution system must be used. Possible covers include half sections of pipe or cavity chambers, as used in leach fields. If piping with orifices is used to distribute flows instead of a pipe with rotating fittings, it is necessary to minimize the headloss in the distribution piping so that the headloss through the orifices controls the flow. This requirement limits the number and size of orifices used, and makes the distribution piping large enough so that the velocity in it is low. The orifices should be evenly spaced at a distance approximately equal to 10% of the cell width. For example, a system 20 m (65 ft) wide should have orifices placed every 2 m (6.5 ft). If poor design causes wastewater to always discharge through only some of the orifices, clogging of the media or accumulation of a surface

layer of solids near those orifices can become a problem, especially for an influent with relatively high suspended solids, such as pond effluent. Finally, the inlet piping should be designed to allow for inspection and clean-out by the operator.

The outlet piping must be designed to minimize the potential for short-circuiting, to maximize even flow collection, and to allow the operator to vary the operating water level and drain the bed. For VSBs with length-width ratios less than one, additional care must be taken to collect the influent from the whole width of the VSB. A collection header with orifices that is placed across the entire width of the bottom of the VSB is recommended to promote even flow. The collection header should be designed with the same hydraulic principles used for inlet distribution piping. Slotted or perforated drainage pipe can be used if the collection header is not too long, but properly sized and spaced orifices in a large diameter collection header allow a designer to use a longer collection header and still achieve balanced flow collection. The recommended maximum distance between orifices in the collection header is 10% of the cell width. The relative potential for clogging with slotted or perforated drainage pipe versus a longer collection header with fewer orifices is unknown. Finally, the outlet piping should be designed to allow for clean-out by the operator.

A simple device to adjust the water level in a separate, covered, outlet box is recommended to achieve variable water level control (see Chapter 6). It is recommended that there be only one collection header and adjustable-level device per cell of a multiple cell VSB system. The adjustable device should allow the operator to flood the VSB to a depth of 50 mm (2 in.) above the surface of the media (for help in weed control), and to draw-down or drain the cell for maintenance.

5.5.4 System Depth, Width and Length

The impact of water depth on pollutant removal is not clear. One problem with almost all published information on VSB systems is that even though the media depth may be known, the actual operating water level is not known. The TTU study found slightly better BOD removal with greater media depth, when comparing 45 cm (18 in) with 30 cm (12 in) systems operated at same areal loading, but it is unclear if this was due only to the increased HRT. No other study has tested this result or determined the optimum depth for a VSB system (George et al., 2000). One study suggested that total root penetration of the media was critical to pollutant removal and recommended that system depth be set equal to the maximum root depth of the wetland species to be used in the VSB (Gersberg et al. 1983). However, as discussed previously, plants supplied with abundant nutrients near the surface will not necessarily grow roots to their maximum depth. As a safety factor Kadlec and Knight (1996) recommend allowing room for solids accumulation in the bottom of the VSB, but the need for this has not been proven. Typical average media depths in VSB systems have ranged from 0.3 to 0.7 m (12

to 28 in.), and various researchers have recommended depths from 0.4 to 0.6 m (16 to 24 in.).

As discussed previously there is evidence for preferential flow below the root zone through media with a higher conductivity. In order to minimize this flow, a shallower depth would be required. On the other hand, a shallower depth may require a greater area to achieve a desired HRT. Until future studies provide better information on optimum water depth, it is recommended to use a design maximum water depth (at the inlet of the VSB) of 0.40 m (16 in.). The depth of the media will be defined by the level of the wastewater at the inlet and should be about 0.1 m (4 in.) deeper than the water.

The overall width of a treatment system using VSBs is defined by Darcy's Law, which is a function of the flow, ALR, water depth and hydraulic conductivity. The width of a individual VSB is set by the ability of the inlet and outlet structures to uniformly distribute and collect the flow without inducing short-circuiting. The recommended maximum width in a TVA design manual is 61 m (200 ft.). If the design produces a larger value, the user should divide the VSB into several cells that do not exceed 61 m in width. As discussed previously, several researchers have noted that most BOD and TSS is removed in the first few meters of a VSB, but some recommend minimum lengths ranging from 12 to 30 m (40 to 100 ft) to prevent short-circuiting. The recommended minimum length for this manual is 15 m (50 ft).

Although much has been made of the aspect (length-width) ratio in early constructed wetlands literature, the only prerequisite for treatment is the area as defined by the ALR. A study by Bounds, et.al. (1998) found that there was no significant difference in TSS or CBOD removal in three parallel VSB systems with aspect ratios of 4:1, 10:1, and 30:1. In all three systems the majority of TSS and CBOD was removed in the first third on the VSB. Removals were also unaffected by stressing the systems with large hydraulic spikes and intermittent loading. The TTU study also found no significant difference in systems with 1:4 and 4:1 aspect ratios (George et al., 2000). Therefore, the aspect ratio is not a factor in the overall design. However, the recommended values for maximum width and minimum length discussed previously will tend to result in individual VSB cells with an length-width ratio between 1:1 and 1:2.

5.6 Design Example for a VSB Treating Septic Tank or Primary Effluent

The design has two basic assumptions. First, the total VSB has four zones (see Figure 5-11). The inlet and outlet zones were discussed in section 5.5.1. Based on the literature as discussed previously, the initial treatment zone will (1) occupy about 30% of the total area, (2) perform most of the treatment, and (3) have a big decrease in hydraulic conductivity (use $K = 1\%$ of clean K). The final treatment zone will occupy the remaining 70% of the area and have little change in hydraulic conductivity (use $K = 10\%$ of clean K). The second basic assumption is that Darcy's

Law, while not exact, it is good enough for design purposes. The sizing of the initial and final treatment zones follows these steps:

- 1) determine the surface area, using recommended ALR
- 2) determine the width, using Darcy's Law
- 3) determine the length and headloss of the initial treatment zone, using Darcy's Law
- 4) determine the length and headloss of the final treatment zone, using Darcy's Law
- 5) determine bottom elevations, using bottom slope
- 6) determine water elevations throughout the VSB, using headloss
- 7) determine water depths, accounting for bottom slope and headloss
- 8) determine required media depth
- 9) determine the number of VSB cells

For this example the following values are given:

- Maximum Monthly Flow (Q) = 200 m³/d
- Maximum Monthly Influent (C₀) BOD = 100 mg/L = 100 g/m³
- Maximum Monthly Influent (C₀) TSS = 100 mg/L = 100 g/m³
- Required discharge limits = 30 mg/L BOD and TSS

Recommended values for VSBs (see Table 5-4) are:

- ALR for BOD = 6 g/m²-d
- ALR for TSS = 20 g/m²-d
- Use washed, rounded media 20-30 mm in diameter, clean K = 100,000 m/d
- Hydraulic conductivity of initial treatment zone (K_i) = 1% of 100,000 = 1000 m/d
- Hydraulic conductivity of final treatment zone (K_f) = 10% of 100,000 = 10,000 m/d
- Bottom slope (s) = % = 0.005
- Design water depth at inlet (D_{w0}) = 0.4 m
- Design water depth at beginning of final treatment zone (D_{wf}) = 0.4 m
- Design media depth (D_m) = 0.6 m
- Maximum allowable headloss through initial treatment zone (dh_i) = 10% of D_m = 0.06 m

5.6.1 Determine the Surface Area (A_s) for Both Pollutants

$$A_s = (Q)(C_0) / \text{ALR}$$

$$\text{For BOD, } A_s = (200 \text{ m}^3/\text{d})(100 \text{ g/m}^3) / 6 \text{ g/m}^2\text{-d} = 3333 \text{ m}^2$$

$$\text{For TSS, } A_s = (200 \text{ m}^3/\text{d})(100 \text{ g/m}^3) / 20 \text{ g/m}^2\text{-d} = 1000 \text{ m}^2$$

Use the larger area requirement, or 3333 m².

$$\text{The surface area for the initial treatment zone (A}_{si}) = (30\%)(3333 \text{ m}^2) = 1000 \text{ m}^2$$

$$\text{The surface area for the final treatment zone (A}_{sf}) = (70\%)(3333 \text{ m}^2) = 2333 \text{ m}^2$$

5.6.2 Determine the Width

Determine the minimum width (W) needed to keep the flow below the surface, using Darcy's Law (Eq. 5-1) and recommended values for the initial treatment zone.

$$Q = (K_i)(W)(D_{w0})(dh_i/L_i)$$

where: L_i = length of initial treatment zone = (A_{si}) / (W)

Substitute and rearrange equation to solve for W:

$$W^2 = (Q)(A_{si}) / (K_i)(dh_i)(D_{w0}) \quad (5-3)$$

For this example:

$$W^2 = (200 \text{ m}^3/\text{d})(1000 \text{ m}^2) / (1000 \text{ m/d})(0.06 \text{ m})(0.4 \text{ m})$$

$$= 8333 \text{ m}^2$$

$$W = 91.3 \text{ m}$$

This is the width for which the headloss equals 0.06 m, given all the parameters as defined. The designer must use a width equal to or greater than this to ensure that the headloss is less than or equal to the design value.

5.6.3 Determine the Length and Headloss (Eq. 5-2) of the Initial Treatment Zone (L_i)

$$L_i = (A_{si}) / (W) = (1000 \text{ m}^2) / (91.3 \text{ m}) = 11.0 \text{ m}$$

This is the length for which the headloss equals 0.06 m, given all the parameters as defined. The designer must use a length less than or equal to this to ensure that the headloss is less than or equal to the recommended value.

$$dh_i = (Q)(L_i) / (K_i)(W)(D_{w0}) = (200 \text{ m}^3/\text{d})(11.0 \text{ m}) / (1000 \text{ m/d})(91.3 \text{ m})(0.4 \text{ m}) = 0.06 \text{ m}$$

5.6.4 Determine the Length and Headloss of the Final Treatment Zone (L_f)

$$L_f = (A_{sf}) / (W) = (2333 \text{ m}^2) / (91.3 \text{ m}) = 25.6 \text{ m}$$

This is the length where the total area of the VSB will be exactly equal to the value set by the ALR. The designer must use a length equal to or greater than this to ensure

that the surface area is equal to or greater than the recommended value.

$$dh_f = (Q)(L_f) / (K_f)(W)(D_{wf}) = (200 \text{ m}^3/\text{d})(25.6 \text{ m}) / (10,000 \text{ m}^2/\text{d})(91.3 \text{ m})(0.4 \text{ m}) = 0.01 \text{ m}$$

5.6.5 Determine Bottom Elevations

E_{be} = elevation of bottom at outlet = 0 (reference point for all elevations)

E_{bf} = elevation of bottom at beginning of final treatment zone = $(s)(L_f) = (0.005)(25.6 \text{ m}) = 0.13 \text{ m}$

E_{bo} = elevation of bottom at inlet = $(s)(L_i + L_f) = (0.005)(11.0 \text{ m} + 25.6 \text{ m}) = 0.18 \text{ m}$

5.6.6 Determine the Water Surface Elevations

E_{wf} = elevation of water surface at beginning of final treatment zone
 $= E_{bf} + D_{wf} = 0.13 \text{ m} + 0.4 \text{ m} = 0.53 \text{ m}$ ($D_{wf} = 0.4 \text{ m}$ was an initial recommended value)

E_{we} = elevation of water surface at outlet = $E_{wf} - dh_f = 0.53 \text{ m} - 0.01 \text{ m} = 0.52 \text{ m}$

E_{wo} = elevation of water surface at inlet = $E_{wf} + dh_i = 0.53 \text{ m} + 0.06 \text{ m} = 0.59 \text{ m}$

5.6.7 Determine Water Depths

D_{wo} = depth of water at inlet = $E_{wo} - E_{bo} = 0.59 \text{ m} - 0.18 \text{ m} = 0.41 \text{ m}$ (about equal to design D_{wo} , so okay.)

D_{wf} = depth of water at beginning of final treatment zone
 $= E_{wf} - E_{bf} = 0.53 \text{ m} - 0.13 \text{ m} = 0.40 \text{ m}$ (equal to design D_{wf} , so okay.)

D_{we} = depth of water at outlet = $E_{we} - E_{be} = 0.52 \text{ m} - 0 = 0.52 \text{ m}$

5.6.8 Determine the Media Depth

The media depth will depend on whether the designer wants a level media surface, or a minimum depth-to-water (D_{tw}) throughout the VSB.

a) If a level surface is desired, the elevation must be greater than the highest water elevation, which is at the inlet, $E_{wo} = 0.59 \text{ m}$. A media elevation set at 0.65 m would be reasonable, and the following media depths and D_{tw} 's result:

D_{m0} = depth of media at inlet = $0.65 \text{ m} - E_{bo} = 0.65 \text{ m} - 0.18 \text{ m} = 0.47 \text{ m}$

D_{mf} = depth of media at beginning of final treatment zone = $0.65 \text{ m} - E_{bf} = 0.65 \text{ m} - 0.13 \text{ m} = 0.52 \text{ m}$

D_{me} = depth of media at outlet = $0.65 \text{ m} - 0 = 0.65 \text{ m}$

D_{tw0} = depth-to-water at inlet = $0.65 \text{ m} - E_{wo} = 0.65 \text{ m} - 0.59 \text{ m} = 0.06 \text{ m}$

D_{twf} = depth-to-water at beginning of final treatment zone = $0.65 \text{ m} - E_{wf} = 0.65 \text{ m} - 0.53 \text{ m} = 0.12 \text{ m}$

D_{twe} = depth-to-water at outlet = $0.65 \text{ m} - E_{we} = 0.65 \text{ m} - 0.52 \text{ m} = 0.13 \text{ m}$

The depth-to-water is small at the inlet (0.06 m) and the designer may want to add an additional layer of media in the first few meters of the initial treatment zone as an added precaution against surfacing, even though the design ALR and K_f values is very conservative. The resulting D_{tw} in the final treatment zone would be 0.12 to 0.13 m, which should not inhibit the growth of aquatic species.

b) If a constant depth-to-water throughout the VSB is desired (e.g. 0.1 m), then the media depth would be calculated as follows:

E_{m0} = elevation of media surface at inlet = $E_{wo} + 0.1 \text{ m} = 0.59 \text{ m} + 0.1 \text{ m} = 0.69 \text{ m}$

E_{mf} = elevation of media surface at beginning of final treatment zone
 $= E_{wf} + 0.1 \text{ m} = 0.53 \text{ m} + 0.1 \text{ m} = 0.63 \text{ m}$

E_{me} = elevation of media surface at outlet = $E_{we} + 0.1 \text{ m} = 0.52 \text{ m} + 0.1 \text{ m} = 0.62 \text{ m}$

D_{m0} = depth of media at inlet = $E_{m0} - E_{bo} = 0.69 \text{ m} - 0.18 \text{ m} = 0.51 \text{ m}$

D_{mf} = depth of media at beginning of final treatment zone = $E_{mf} - E_{bf} = 0.63 \text{ m} - 0.13 \text{ m} = 0.56 \text{ m}$

D_{me} = depth of media at outlet = $E_{me} - 0 = 0.62 \text{ m} - 0 = 0.62 \text{ m}$

This approach would result in a drop in the media surface of (0.69 m - 0.51 m) of 0.18 m over the 11.0 m length of the initial treatment zone (slope = 1.6%), which would probably not impair operation and maintenance activities.

5.6.9 Determine Number of VSB Cells

It is recommended that at least two VSBs be used in parallel in all but the smallest systems, so that one of the VSBs can be taken out of service for maintenance or repairs without causing serious water quality violations. In this example, the total size of the VSB system is 91.3 m wide by 36.6 m long. Therefore, use two VSBs, each 46 m wide and 37 m long could be used. Other combinations of length and width that have the required surface area will also work as long as the hydraulics conditions are met. Also remember that inlet and outlet zones will add to the overall length of the VSB.

Table 5-4. Summary of VSB Design Guidance.

Pretreatment	Recommended for use after primary sedimentation (e.g. septic tank, Imhoff tank, primary clarifier) VSBs not recommended for use after ponds because of problems with algae
Surface Area	Based on desired effluent quality and areal loading rates as follows:
BOD	6 g/m ² -d (53.5 lb/ac-d) to attain 30 mg/L effluent
BOD	1.6 g/m ² -d (14.3 lb/ac-d) to attain 20 mg/L effluent
TSS	20 g/m ² -d (178 lb/ac-d) to attain 30 mg/L effluent
TKN	Use another treatment process in conjunction with VSB
TP	VSBs not recommended for phosphorus removal
Depth	
Media (typical)	0.5 - 0.6 m (20 - 24 in.)
Water (typical)	0.4 - 0.5 m (16 - 20 in.)
Length	As calculated (see design example); minimum of 15 m (49 ft)
Width	As calculated (see design example); maximum of 61 m (200 ft)
Bottom slope	0.5 - 1%
Top slope	level or nearly level
Hydraulic Conductivity	
First 30% of length	1% of clean K
Last 70% of length	10% of clean K
Media	
All media should be washed clean of fines and debris; more rounded media will generally have more void spaces; media should be resistant to crushing or breakage.	
Inlet zone [1st 2 m (6.5 ft)]	40 - 80 mm (1.5 - 3.0 in)
Treatment zone	20 - 30 mm (3/4 - 1 in) [use clean K = 100,000, if actual K not known]
Outlet zone [last 1 m (3.2 ft)]	40 - 80 mm (1.5 - 3.0 in)
Planting media [top 10 cm (4 in.)]	5 - 20 mm (1/4 - 3/4 in)
Miscellaneous	Use at least 2 VSBs in parallel Use adjustable inlet device with capability to balance flows Use adjustable outlet control device with capability to flood and drain system

5.7 On-site Applications

A number of states, including Louisiana, Kentucky, Kansas, Arkansas, Texas and Indiana, have used VSBs for on-site wastewater management. Kentucky alone lists over 4000 such installations (Thom et al., 1998). Most of these states have adopted VSBs as a pretreatment step prior to soil infiltration in an effort to protect groundwater by over-

coming the inadequate purification capacity of certain soils. They view VSBs as passive systems with low operation and maintenance requirements.

A review of various on-site VSB design guidelines by Mankin and Powell (1998) revealed that there was a large variation among the designs. Recommended depth varied from 0.3 to 0.8 m (1 to 2.5 ft), with the great majority between 0.3 and 0.5 m (1 and 1.5 ft). For a three bedroom house typical VSB areas varied from < 10 m² to > 100 m² (104 to 1088 ft²), HRTs varied from 1.3 to 6.5 d, and length-width ratio varied from 71:1 to 1.8:1. Median values were a depth of 0.45 m (1.5 ft), area of 30 m² (315 ft²), and HRT of 4.7 d. Gravel size guidelines varied from 0.65 cm (0.25 in.) to 7.5 cm (3.0 in.)

These authors sampled three typical VSB systems in Kansas and compared them with other reported data. Despite employing a larger than average area, the units failed to meet a 30/30 BOD/TSS requirement at two of the three sites.

Given the general lack of operation and maintenance requirements and the potential aesthetic appearance of VSB systems, their attractiveness to local and state regulators is quite predictable. As a passive system potentially capable of meeting a 30/30 BOD/TSS requirement, they have obvious advantages over mechanical systems which require a significant management program and electrical support to function satisfactorily. Also, their general reliability, when compared to mechanical systems, offers additional protection against clogging of the soil's infiltrative surface.

Based on the VSB design guidance presented previously, a three bedroom home would require a VSB of 100 m², assuming six persons and a BOD loading of 100 g/cap-d. As expected, due to the conservative nature of the design approach presented in this chapter, this area is at the high end of the areas found by Mankin and Powell (1998).

There should be minimal deviation from the recommendations of Table 5-4, except that simplified inlet and outlet configurations, appropriate for small on-site systems, can be used. As with larger VSBs, some means of post-aeration and disinfection will be required if surface discharge is contemplated. Discharge to soil infiltration is more likely, and soil absorption guidelines provided by the State will apply.

5.8 Alternative VSB Systems

Alternative VSB systems are those that operate with some schedule of filling and draining the media. Fill and drain VSB systems are similar to sequencing batch reactors, intermittent sand filters, or overland flow systems in that the flow into a single cell of a system is intermittent. Draining a VSB system is a simple way to introduce more oxygen into the media. Clearly plants are playing a lesser role in these systems and they are inherently quite different from a natural wetland. Nevertheless they are discussed here because they have been identified as constructed

wetlands and have evolved from conventional VSB systems. They are more complex to operate than a conventional VSB system.

One of the first and more unconventional alternative VSB systems was developed in England and tested in England and Egypt in the late 1980s (May et al., 1990). The system, called a gravel bed hydroponic system, is very similar to an overland flow process except that the wastewater flows through 8-10 cm (3-4 in) of gravel. Loading is typically intermittent except when denitrification is desired.

Researchers at TTU (1999) experimented with alternating fill and drain VSB wetlands for one year in 1994 and compared the results to conventional VSBs in side by side testing. The alternating fill and drain cells followed a conventional VSB cell. Effluent from the fill and drain cells was recycled back to the conventional cell. They found some improvement in nitrogen removal but overall the results were not as good as they had expected.

Researchers at TVA have developed (and patented) a system in which the wastewater is quickly drained from one wetland cell and pumped into a second parallel cell (Behrends, et al., 1996). The draining and filling occurs within 2 hours and then the process is reversed; the second cell is drained quickly and the first cell is refilled. The reciprocating flow process is repeated continuously, with a small amount of influent continually added to the first cell and a fraction of the wastewater continually drawn from the second cell as effluent. The reciprocating two cell system was compared with a conventional two cell system for six months in side by side testing in late 1995 and early 1996 at Benton, Tennessee. Continued operation of both two-cell pairs in the reciprocating mode has continued since May of 1996. Comparing conventional operation to the reciprocating mode, the reciprocating mode produced significantly lower effluent BOD and ammonia nitrogen.

One of the most studied full-scale VSB systems is located at the Village of Minoa in New York State (see Chapter 9). Two New York State agencies and the USEPA provided grant funds to the Village for incorporation of several special features in the VSB system and for a research and technology transfer study of the system by researchers at Clarkson University, Potsdam, NY. The system was originally designed and operated as a conventional VSB system, but during 15 months treating a primary effluent, the system performed very poorly compared to its design expectations. Faced with numerous complaints from nearby residents about hydrogen sulfide odors, the operators started operating the system with occasional draw-down periods to control odors. The drawdown significantly reduced odors. In April 1997, when the experimental plan for the system called for the three cells to operated in series, the Minoa operators decided to increase the flow by 100% and change the operation to a fill and drain mode. The fill and drain operation included a resting period during the drained condition and continuous operation for some time after filling. The fill and drain operation eliminated the hydrogen sulfide odors and also resulted in a significant

improvement in the effluent quality. However, the operators were not satisfied with the improved performance and experimented further. In 1998 they changed the operation to a mode that continued to the writing of this manual. Two of the wetland cells operate in a parallel fill and drain mode very similar to sequencing batch reactors. The third cell is operated in a conventional mode but in series with the first two cells. This mode of operation has resulted in an additional significant improvement in effluent quality over the previous fill and drain mode of operation. See section 9.8 for a more detailed description of the operation and the results.

Within the last five years, several unsaturated vertical flow systems have been constructed and tested in Europe. Most have been used for tertiary treatment of secondary effluents but they have also been used for treating septic tank and sugar beet processing effluents. They appear to perform significantly better than conventional VSB systems. Recommended design loadings are approximately twice that for conventional VSB systems.

5.9 References

- Batchelor, A. and P. Loots. 1997. A critical evaluation of a pilot scale subsurface flow wetland: 10 years after commissioning. *Water Science & Technology*, 35(5):337-343.
- Bavor, H.J., D.J. Roser, P.J. Fisher, and I.C. Smalls. 1989. Performance of solid-matrix wetland systems viewed as fixed-film bioreactors. In: D.A. Hammer (ed.) *Constructed Wetlands for Wastewater Treatment*. Chelsea, MI: Lewis Publishers, pp. 646-656.
- Bavor, H.J. and T.J. Schulz. 1993. Sustainable suspended solids and nutrient removal in large-scale, solid matrix, constructed wetland systems. In: G.A. Moshiri (ed.) *Constructed wetlands for water quality improvement*. Boca Raton, FL: Lewis Publishers, pp. 219-225.
- Behrends, L.L., Coonrod, H.S., Bailey E. and M.J. Bulls. 1993. Oxygen Diffusion Rates in Reciprocating Rock Biofilters: Potential Applications for Subsurface Flow Constructed Wetlands. In: *Proceedings Subsurface Flow Constructed Wetlands Conference*, August 16-17, 1993, University of Texas at El Paso.
- Behrends, L.L., F. J. Sikora, H.S. Coonrod, E. Bailey and C. McDonald. 1996. Reciprocating Subsurface-Flow Constructed Wetlands for Removing Ammonia, Nitrate, and Chemical Oxygen Demand: Potential for Treating Domestic, Industrial and Agricultural Wastewater. Vol 5, Pp 251-263. In: *Proceedings of the Water Environment Federation 69th Annual Conference*. Dallas, TX.
- Bhattarai, R.R. and D.M. Griffin, Jr. 1998. Results of tracer tests in rock plant filters. Department of Civil Engineering, Louisiana Tech University, Ruston, LA.
- Bounds, H.C., J. Collins, Z. Liu, Z. Qin, and T.A. Sasek. 1998. Effects of length-width ratio and stress on rock-plant filter operation. *Small Flow Journal*, 4(1):4-14.

- Bowmer, K.H. 1987. Nutrient removal from effluents by an artificial wetland: influence of rhizosphere aeration and preferential flow studied using bromide and dye tracers. *Water Research*, 21(5):591-599.
- Breen, P.F. and A.J. Chick. 1995. Rootzone dynamics in constructed wetlands receiving wastewater: a comparison of vertical and horizontal flow systems. *Water Science & Technology*, 32(3):281-290.
- Chalk, E. and G. Wheale. 1989. The root-zone process at Holtby Sewage Treatment Works. *Journal IWEM*, 3:201-207.
- Cooper, P.F. 1990. European Design and Operations Guidelines for Reed Bed Treatment Systems, Rep. UI17, Water Research Centre, Swindon, U.K.
- Cooper, P.F., J.A. Hobson and S. Jones. 1989. Sewage Treatment by Reed Bed Systems. *Journal of the Institution of Water and Environmental Management*. 3 (1) 60.
- Crites, R. and G.Tchobanoglous. 1998. Small and decentralized wastewater management systems. San Francisco, CA: McGraw-Hill.
- Dahab, M.F. and R.Y. Surampalli. 1999. Predicting Subsurface Flow constructed Wetlands Performance: A Comparison of Common Design Models. In: Proceedings of the Water Environment Federation 72th Annual Conference. New Orleans, LA.
- DeShon, G.C., A.L. Thompson, and D.M. Sievers. 1995. Hydraulic properties and relationships for the design of subsurface flow wetlands. Presented at Versatility of Wetlands in the Agricultural Landscape Conference, Tampa, FL, Sept 17-20, 1995.
- Fisher, P.J. 1990. Hydraulic characteristics of constructed wetlands at Richmond, NSW, Australia. In: P.F. Cooper and B.C. Findlater (eds.) *Constructed Wetlands in Water Pollution Control*. Oxford, UK: Pergamon Press, pp. 21-31.
- Gearheart, R.A. 1998. Use of FWS constructed wetlands as an alternative process treatment train to meet unrestricted water reclamation standards. Presented at AWT-98, Advanced Wastewater Treatment, Recycling and Reuse, Milan, Italy, pp. 559-567.
- Gearheart, R.A. et al. 1999. Free water surface wetlands for wastewater treatment: a technology assessment. USEPA, Office of Water Management, US Bureau of Reclamation, City of Phoenix, AZ.
- George, D.B. et al. 2000. Development of guidelines and design equations for subsurface flow constructed wetlands treating municipal wastewater. USEPA, Office of Research and Development, Cincinnati, OH.
- Gersberg, R.M., B.V. Elkins and C.R. Goldman. 1983. Nitrogen Removal in Artificial Wetlands. *Water Research* 17 (9) 1009.
- Gersberg, R.M. et al. 1984. The Removal of Heavy Metals by Artificial Wetlands, In: Proc Water Reuse Symp. III, Vol 2, AWWA Research Foundation, 639.
- Gersberg, R.M., et al. 1986. Role of Aquatic Plants in Wastewater Treatment by Artificial Wetlands. *Water Research* 20 (3) 363.
- Gersberg, R.M., Gearheart, R.A., and M. Ives. 1989. Pathogen Removal in Constructed Wetlands, Proc. From First International Conference on Wetlands for Wastewater Treatment, Chattanooga, TN, June 1988, Ann Arbor Press.
- Green, M.B. and J. Upton. 1994. Constructed Reed Beds: A Cost-Effective Way to Polish Wastewater Effluents for Small Communities. *Water Env. Res.* 66 (3) 188.
- Griffin, P., B. Green and A.Pritchard. 1998. Pathogen Removal in Subsurface Flow Constructed Reed Beds. In: Proceedings of the Water Environment Federation 71st Annual Conference. Orlando, FL.
- Heukelekian, H. and J.L. Balmat. 1959. Chemical composition of the particulate fractions of domestic sewage. *Sewage & Industrial Wastes*, 81:413-423.
- Jenssen, P.T. M. Muehlan, and T. Kregstad. 1993. Potential use of constructed wetlands for wastewater treatment in northern environments. In: Proceedings of 2nd International Conference on Design and Operation of Small Wastewater Treatment Plants, pp. 193-200.
- Kadlec, R.H. and R.L. Knight. 1996. *Treatment Wetlands*. Boca Raton, FL: Lewis-CRC Press.
- Kadlec, R.H. and J.T. Watson. 1993. Hydraulics and solids accumulation in a gravel bed treatment wetland. In: G.A. Moshiri (ed.) *Constructed wetlands for water quality improvement*. Boca Raton, FL: Lewis Publishers, pp. 227-235.
- Kickuth, R. 1981. Abwasserreinigung in mosaikmatrizen aus aeroben und anaerobenteilbezirken. In: F. Moser (Ed), *Grundlagen der Abwassereinigung*, pp 639-665.
- King, A.C., C.A. Mitchell, and T. Howes. 1997. Hydraulic tracer studies in a pilot scale subsurface flow constructed wetland. *Water Science & Technology*, 35(5):189-196.
- Liehr, R.K. et al. 2000. Constructed wetlands treatment of high nitrogen landfill leachate. Project Number 94-IRM-U, Water Environment Research Foundation, Alexandria, VA.

- Macmanus, B.E., A.L. Thompson, and D.M. Sievers. 1992. Predicting water mounding in subsurface rock bed wetlands. Presented at the Mid-Central Conference of the American Society of Agricultural Engineers, St. Joseph, MO, March 13-14, 1992.
- Mankin, K.R. and G.M. Powell. 1998. Onsite rock-plant filter monitoring and evaluation in Kansas. In: Proceedings of 8th National Symposium on Individual and Small Community Sewage Systems, ASAE, St. Joseph, MI.
- May, E., J.E. Bulter, M.G. Ford, R.F. Ashworth, J.S. Williams and M.M.M. Baghat. 1990. Comparison of Chemical and Microbiological Processes in Gravel Bed Hydroponic (GBH) Systems for Sewerage Treatment. In: Constructed Wetlands in Water Pollution Control. Cooper and Findlater (Eds) Pergamon Press U.K.
- Netter, R. and W. Bischofsberger. 1990. Hydraulic investigations on planted soil filters. In: P.F. Cooper and B.C. Findlater (eds.) Constructed Wetlands in Water Pollution Control. Oxford, UK: Pergamon Press, pp. 11-20.
- Netter, R. 1994. Flow characteristics of planted soil filters. *Water Science & Technology*, 29(4):37-44.
- Odegaard, M. 1987. Particle separation in wastewater treatment. In: Proceedings of 7th European Sewage and Refuse Symposium, EWPCA, pp. 351-400.
- Peverly, J.H., J.M. Surface and T. Wang. 1995. Growth and Trace Metal Absorption by *Phragmites australis* in Wetlands constructed for Landfill Leachate Treatment. *Ecological Engineering* 5, 21.
- Rash, J.K. and S.K. Liehr. 1999. Flow pattern analysis of constructed wetlands treating landfill leachate. *Water Science & Technology*, 40(3):309-315.
- Reedy, K.R. and W.F. DeBusk. 1985. Nutrient removal potential of selected aquatic macrophytes. *J. Environmental Quality*, 19:261.
- Reed, S.C., R.W. Crites and E.J. Middlebrooks. 1995. *Natural Systems for Waste Management and Treatment*. 2nd Ed. NY: McGraw Hill.
- Reed, S.C. and S. Giarrusso. 1999. Sequencing Operation Provides Aerobic Conditions in a Constructed Wetland. In: Proceedings of the Water Environment Federation 72th Annual Conference. New Orleans, LA.
- Richard, M. and J. Snyder. 1994. Results of the pilot wetlands study at Las Animas, CO. Report to the City of Las Animas, Colorado State University, CO.
- Sanford, W.E., T.S. Steenhuis, J-Y. Parlange, J.M. Surface, and J.H. Peverly. 1995a. Hydraulic conductivity of gravel and sand as substrates in rock-reed filters. *Ecological Engineering*, 4:321-336.
- Sanford, W.E., T.S. Steenhuis, J.M. Surface, and J.H. Peverly. 1995b. Flow characteristics of rock-reed filters for treatment of landfill leachate. *Ecological Engineering*, 5:37-50.
- Sanford, W.E. 1999. Substrate type, flow characteristics, and detention times related to landfill leachate treatment efficiency in constructed wetlands. In: G. Mulamootil, E.A. McBean, and F. Rovers (eds.) *Constructed wetlands for the treatment of landfill leachate*. Boca Raton, FL: Lewis Publishers, pp. 47-56.
- Sapkota, D.P. and H.J. Bavor. 1994. Gravel bed filtration as a constructed wetland component for the reduction of suspended solids from maturation pond effluent. *Water Science & Technology*, 29(4):55-66.
- Smith, I.D., G.N. Bis, E.R. Lemon and L.R. Rozema. 1997. A Thermal Analysis of a Sub-surface, Vertical Flow Constructed Wetland. *Wat. Sci. Tech.* 35 (5) 55.
- Stengel, E. and Schultz-Hock, R. 1989. Denitrification in artificial wetlands. In: D.A. Hammer (ed.) *Constructed Wetlands for Wastewater Treatment*. Chelsea, MI: Lewis Publishers, pp. 484-492.
- Surface, J.M., J.H. Peverly, T.S. Steenhuis, and W.E. Sanford. 1993. Effect of season, substrate composition, and plant growth on landfill leachate treatment in a constructed wetland. In: G.A. Moshiri (ed.) *Constructed wetlands for water quality improvement*. Boca Raton, FL: Lewis Publishers, pp. 461-472.
- Tanner, C.C. and J.P. Sukias. 1995. Accumulation of organic solids in gravel-bed constructed wetlands. *Water Science & Technology*, 32(3):229-239.
- Tanner, C.C., J.P.S. Sukias, and M.P. Upsdell. 1998. Organic matter accumulation during maturation of gravel-bed constructed wetlands treating farm dairy wastewaters. *Water Research*, 32(10):3046-3054.
- Thom, W.O., Y.T. Yang, and J.S. Dinger. 1998. Long-term results of residential constructed wetlands. In: Proceedings of 8th National Symposium on Individual and Small Community Sewage Systems, ASAE, St. Joseph, MI.
- USEPA. 1993. *Subsurface Flow Constructed Wetlands for Wastewater Treatment, A Technology Assessment*. EPA 832-R-93-008.
- Vanier, S.M. and M.F. Dahab. 1997. Evaluation of Subsurface Flow Constructed Wetlands for Small Community Wastewater Treatment in the Plains. In: Proceedings of the Water Environment Federation 70th Annual Conference. Chicago, IL.
- van Oostrom, A.J. and R.N. Cooper. 1990. Meat processing effluent treatment in surface-flow and gravel-bed

constructed wastewater wetlands. In: P.F. Cooper and B.C. Findlater (eds.) *Constructed Wetlands in Water Pollution Control*. Oxford, UK: Pergamon Press, pp. 321-332.

Watson, J.T., K.D. Choate, and G.R. Steiner. 1990. Performance of constructed wetland treatment systems at Benton, Hardin, and Pembroke, Kentucky, during the early vegetation establishment phase. In: P.F. Cooper and B.C. Findlater (eds.) *Constructed Wetlands in*

Water Pollution Control. Oxford, UK: Pergamon Press, pp. 171-182.

WEF. 1998. *Manual of Practice #8*. Water Environment Federation, Alexandria, VA.

Young, T.C., A.G. Collins, and T.L. Theis. 2000. *Subsurface flow wetland for wastewater treatment at Minoa, NY*. Report to NYSERDA and USEPA, Clarkson University, NY.

Chapter 6

Construction, Start-up, Operation, and Maintenance

6.1 Introduction

Constructed wetland systems require infrequent operation and maintenance activities to achieve performance goals if they are designed and constructed properly. This chapter discusses construction details, start-up procedures, and operation and maintenance activities for both free water surface wetlands and vegetated submerged beds.

6.2 Construction

Construction of wetland systems primarily involves common earth moving, excavating, backfilling, and grading. Most of the equipment and procedures are the same as those employed for construction of lagoons, shallow ponds, and similar containment basins. However, there are aspects that require special attention to ensure flow through the wetland is uniform over the design treatment volume. Also, establishment of vegetation is unique to the basin construction and not always within the repertoire of construction contractors. It is the intent of this section to provide guidance on these special and unique aspects of wetland construction.

6.2.1 Basin Construction

The basic containment structure of constructed wetlands consists of berms and liners. The structural and watertight integrity of the liner and surrounding berm are critical. Failure of either will result in loss of water, risk of ground water pollution, and possible loss of plants due to the decline of the water level in the wetland.

6.2.1.1 Basin Layout

The topography of the site will dictate the general shape and configuration of the wetland. Constructing the wetland on sloping sites with the long axis along the contour will minimize the grading requirements. With proper layout, long sloping sites can reduce pumping costs by taking advantage of the available fall.

6.2.1.2 Site Preparation

Clearing and grubbing, rough grading, and berm construction use the same procedures, techniques, and equipment used for lagoons and conventional water containment basins. If possible, it is desirable to balance the cut and fill on the site to avoid the need for remote borrow pits

or soil disposal. If agronomic-quality topsoil exists on the site, it should be stripped and stockpiled. In the case of FWS wetlands, the topsoil can be utilized as the rooting medium for the emergent vegetation and revegetation of the berm surfaces. A soil-rooting medium is not required for VSB systems.

To meet its performance expectations, it is critically important for the water to flow uniformly through the entire wetland area. Severe short-circuiting of flow can result from improper grading or nonuniform subgrade compaction. The operating water depth may be 60 cm (2 ft) or less, so irregularities in the bottom surface can induce preferential flow paths. Specified tolerances for grading will depend on the size of the wetland. A very large FWS wetland of several thousand acres cannot afford the effort to fine grade to very close tolerances. Therefore, the wetland should be subdivided into several smaller cells or the design should incorporate a sizing safety factor to compensate for potential short-circuiting. For smaller wetlands of a few hundred hectares or less, it is usually cost effective to specify closer grading tolerances. Bottom grades are an important consideration when converting existing lagoons to wetlands. Because of the design depths in lagoons, careful grading of the bottom may not have been required. In many cases in which conversions were made without careful regrading, significant short-circuiting has occurred that reduced the wetland treatment performance.

Uniform compaction of the subgrade is also important to protect the liner integrity from subsequent construction activity (i.e., liner placement, soil placement for FWS wetlands, gravel placement for VSB systems) and from stress when the wetland is filled. The loading on the liner is approximately 2,200 kg/m² (450 lbs/ft²) including the plant mass. Short-circuiting of flow through a FWS wetland also can result from ruts and low areas in the subgrades. The subgrade should be uniformly compacted to the same levels used for native soils in road subgrades.

Fine grading and compaction of the native subgrade soils also depends on the liner requirements. Most wetland cells are graded level from side to side and either level or with a slight slope in the direction of flow. Wetlands are often constructed with a bottom slope of 1% or less which is sufficient to drain the cell if and when maintenance is required.

6.2.1.3 Berms

Berms in constructed wetlands contain water within specific flow paths. Exterior berms are designed to prevent unregulated flow releases. Interior berms are used to augment flow distribution. Exterior berms are typically built to provide 0.6 to 1 m (2–3 ft) of freeboard with a width at least 3 m (10 ft) at the top to permit service vehicle access. The amount of freeboard should be enough to contain a given storm rainfall amount. Side slopes should be a maximum of 3:1; however, slopes of 2:1 have been used for internal side slopes, particularly when liners or erosion control blankets are used. Access ramps into each cell of the system should be shallow enough for maintenance equipment to enter. All berms should be constructed in conformance with standard geotechnical considerations, for they may be subject to local dam safety regulations. Design considerations for internal berms, however, are less critical since they are not designed for water containment. See Figure 6-1 for typical design features of constructed wetland berms.

Short-circuiting around the edges of cells has been experienced in some FWS wetlands where vegetation on the berm slope is absent. This is a particular problem if syn-

thetic liners are used. The liners do not provide a good rooting medium and so may remain bare. The open water gap between the berm and the vegetated area in the wetland proper provides a preferential flow path. A soil layer can be placed on the berm side slope to establish vegetation, but the slope is very susceptible to erosion, particularly near the water line. The soil loss from erosion will have the added impact of reducing the detention time in the wetland. This has not been a problem in clay-lined wetlands because the clay provides a good rooting medium.

6.2.1.4 Liners

Liners used for wetlands are the same as those typically used for lagoons and ponds. The materials include:

Polyvinyl chloride (PVC)

Polyethylene (PE)

Polypropylene

Most systems typically use 30 mil polyvinyl chloride (PVC) or high-density polyethylene (HDP). These may be prefabricated for small, individual-residence wetlands, but

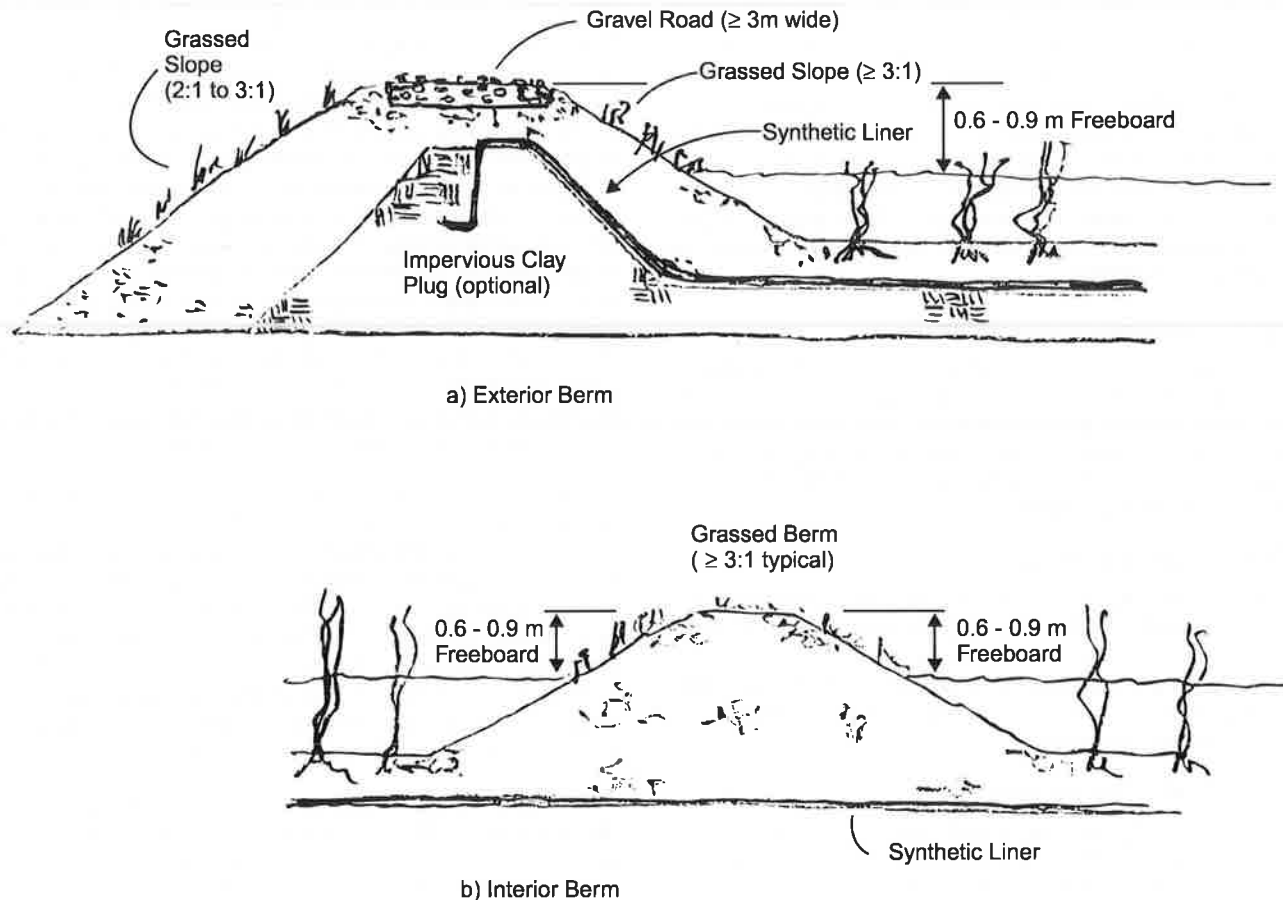


Figure 6-1. Examples of constructed wetland berm construction

they are usually constructed in place using conventional procedures for assembly, joint bonding, and anchoring. Liners also may include scrims, which are more costly. The scrim is a woven nylon or polypropylene net embedded in plastic or surrounding bentonite. Plastic liners with scrims are marketed under trade names such as Hypalon or XR-5. Several good resources are available for liner application and selection (EPA, 1993; EPA, 1994; Rumer and Mitchell, 1996).

Liner punctures must be prevented during placement and subsequent construction activity. If the subgrade contains sharp stones, a geotextile fabric should be placed beneath the liner. A geotextile fabric or a layer of sand approximately 5 cm (2 in) thick should be placed on top of the liner if crushed rock is used in a VSB system. The engineer should specify that the liner installer provides written approval of the condition of the subgrade as a condition prior to liner installation.

Many membrane liners currently used require protection from ultraviolet solar radiation. Conventional methods can be used to achieve protection, but VSB systems should not use a soil cover as UV protection since erosion may wash soil into the bed and result in local media clogging. Riprap material consisting of aggregate approximately 8–15 cm (3–6 in) in size is recommended for this application. This larger riprap will reduce the potential for weeds to become established and spread into the wetland. It can also withstand foot traffic for the life of the system.

Clay liners also have been used. Manufactured liners using bentonite are common. The bentonite may be mixed with the native soils and compacted, or it may be in the form of pads or blankets consisting of bentonite between two scrims of finely woven polypropylene or polyethylene.

Native soils may be used if they have sufficiently high clay content to achieve the necessary permeability. Usually the state regulatory agency will specify the acceptable permeability. Typically, the clay liner must be 0.3 m (1 ft) or more in thickness to provide the necessary hydraulic barrier. In the case of a FWS, the surface of the clay layer should be well compacted to discourage root penetration by the emergent vegetation as the wetland matures.

6.2.1.5 Inlet and Outlet Structures

Inlet and outlet structures distribute the flow into the wetland, control the flow path through the wetland, and control the water depth. Multiple inlets and outlets spaced across either end of the wetland are essential to ensure uniform influent distribution into and flow through the wetland. These structures help to prevent “dead zones” where exchange of water is poor, resulting in wastewater detention times that can be much less than the theoretical detention times.

In small- to medium-sized wetlands, perforated or slotted manifolds running the entire wetland width typically are used for both the inlets and outlets. Sizes of the manifolds, orifice diameters, and spacing are a function of the

projected flow rate. For example, the first cell of the FWS wetland in West Jackson County, MI, is designed for an average flow of 2,270 m³/d (600,000 gpd). It uses a 300 mm (12 in)-diameter PVC manifold for the inlet that extends the full 76 m (250 ft) width of the cell. The manifold is perforated with 50 mm (2 in)-diameter orifices on 3 m (10 ft) centers. It rests on a concrete footing to ensure stability and discharges to a 150 mm (6 in)-thick layer of coarse aggregate. A single inlet would not be suitable for a wide wetland cell such as this because it would not be possible to achieve uniform flow across the cell. Multiple weir boxes could be used as an alternative. Splitter boxes using “V” notched weirs or other methods can be used to divide the influent flow equally between the individual weir boxes. The weir boxes also can be used for measuring the influent flow. Examples of these types of structures can be found in irrigation engineering textbooks.

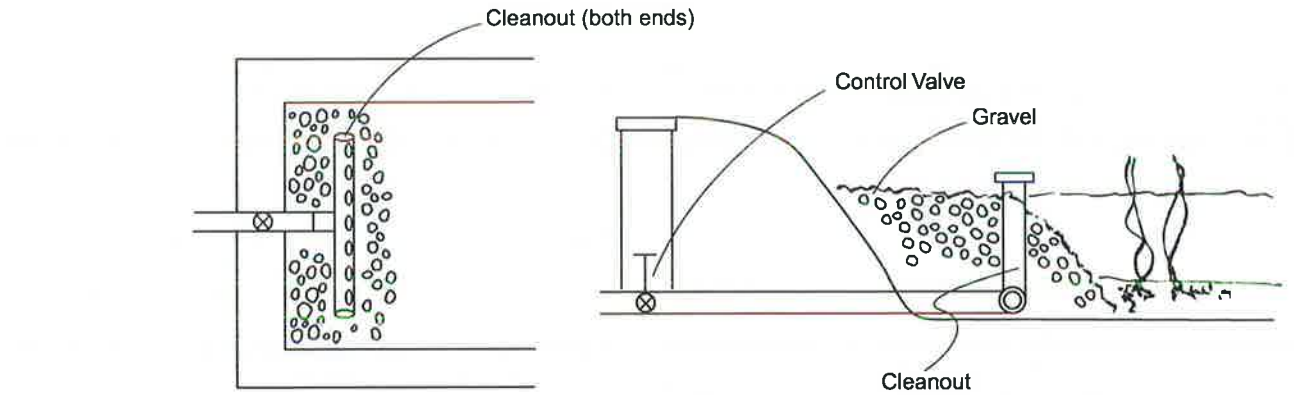
Where possible, the inlet manifold should be installed in an exposed position to allow access by the operator for flow adjustment and maintenance. Several alternatives to the simple drilled orifice can be used for flow distribution control. See Figure 6-2 for examples of inlet manifolds.

In cold climates where extended periods of freezing weather are possible or where public exposure is an issue, a submerged inlet is necessary. In these instances, the simple perforated inlet manifold is used. Since it is not possible to adjust the level of the submerged manifolds after construction is completed, extra effort should be expended to compact and grade the inlet and outlet zones to limit subsequent settling. It may be necessary to support the manifold on concrete footings where the underlying soils are potentially unstable. An accessible cleanout should be provided at each end of the submerged manifold to allow flushing if the manifold becomes clogged. Shut-off devices should be provided on all inlets to permit maintenance or resting of the wetland.

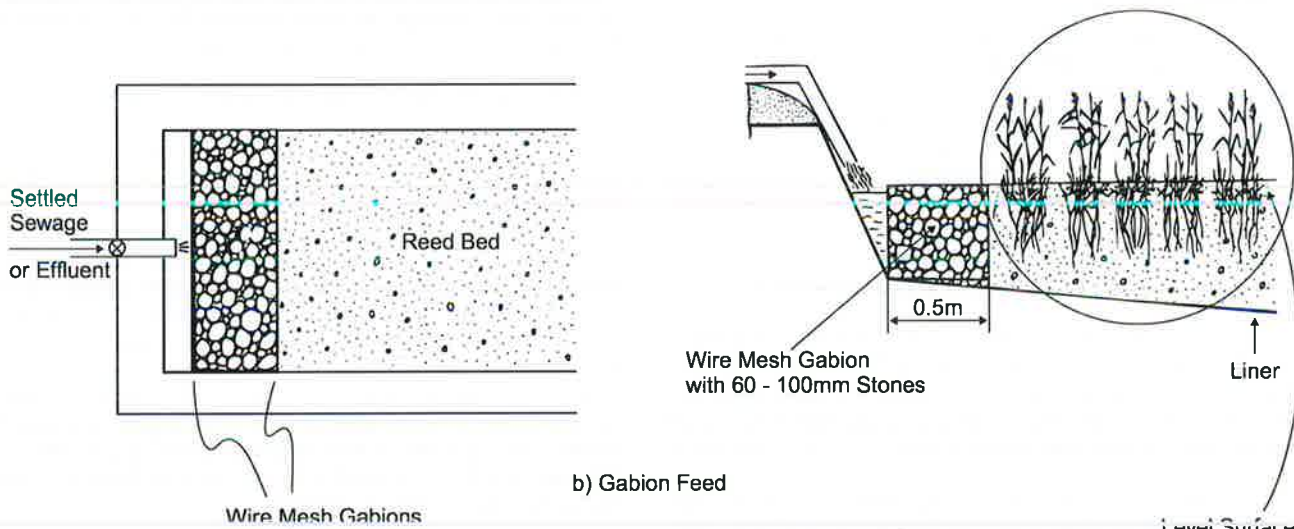
In FWS wetlands, the encroachment of adjacent emergent vegetation may clog the manifold outlets with plant litter and detritus. This problem may be eliminated by constructing a deep water zone approximately 1–1.3 m (3–4 ft) deeper than the bottom of the rest of the wetland. The open area should be limited to 1 m (3 ft) in width. The manifold also can be enclosed in a berm of coarse riprap 8–15 cm (3–6 in) in size. The coarse riprap inhibits plant growth. The open water design, however, allows easier access to the manifold for maintenance, but may encourage wildlife visitation and the potential effluent quality degradation that accompanies it.

Outlet structures help to control uniform flow through the wetland as well as the operating depth. If submerged outlet manifolds are used, they must be connected to a level control device that permits the operator to adjust the water depth in the wetland. This device can be an adjustable weir or gate, a series of stop logs, or a swiveling elbow (Figure 6-3).

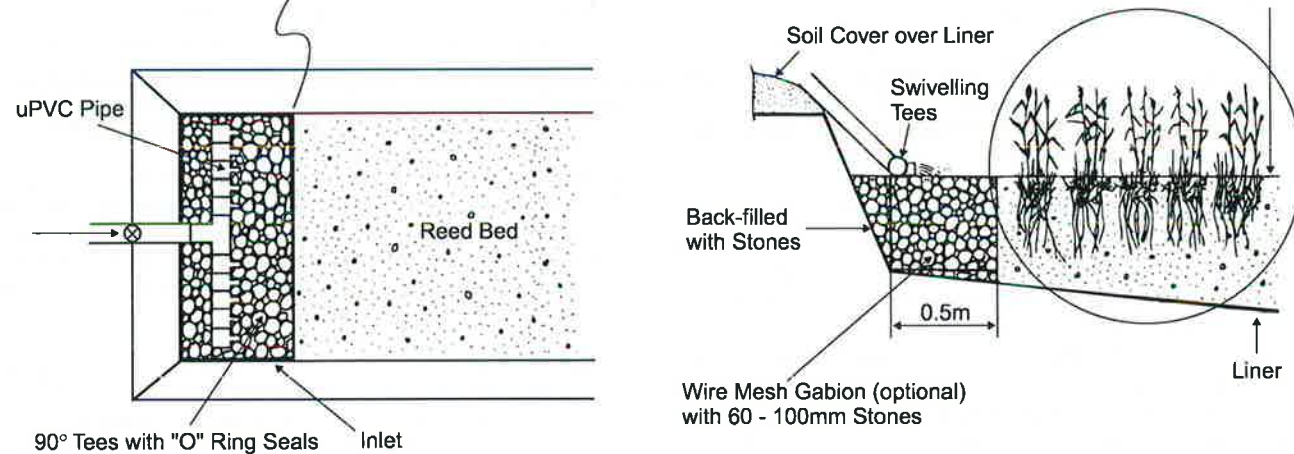
An alternative to submerged manifolds for inlet and outlet structures is multiple weir or drop boxes. These are



a) Submerged Perforated Pipe

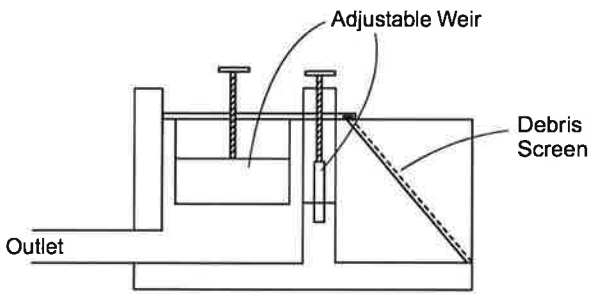
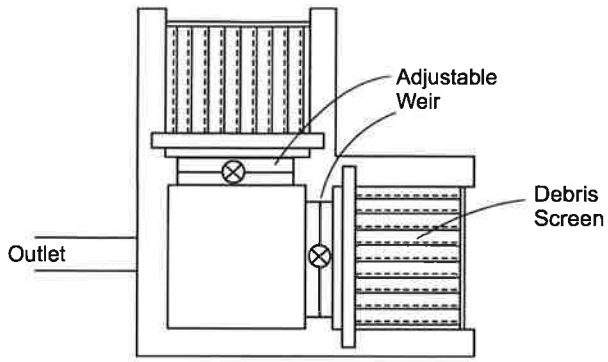


b) Gation Feed

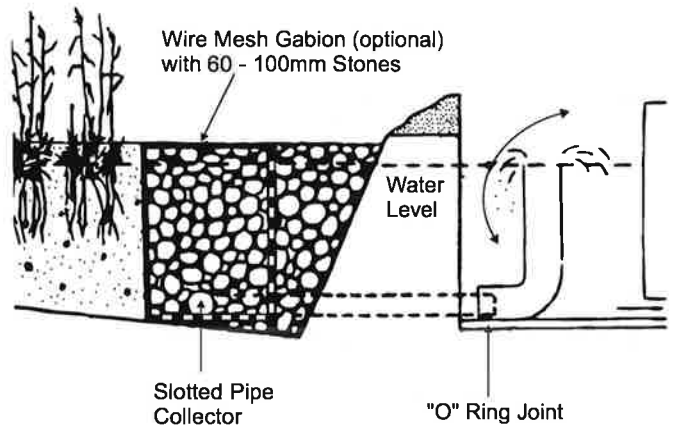


c) Swivel Tee

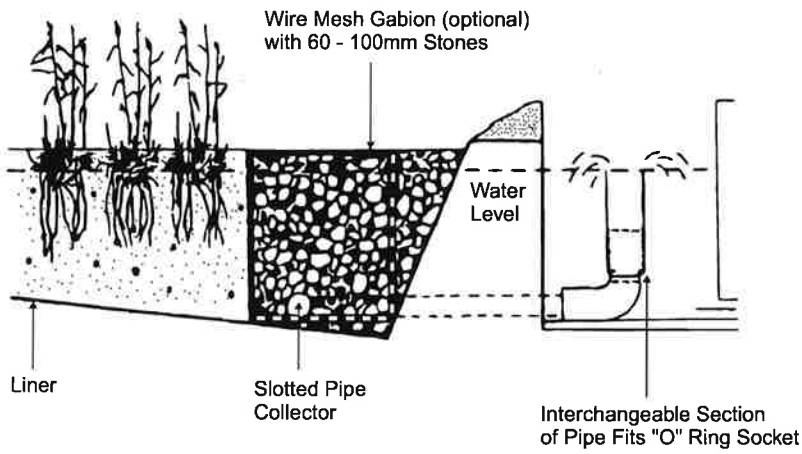
Figure 6-2. Examples of constructed wetland inlet designs



a) Adjustable Weir



c) 90° Elbow Arrangement



b) Interchangeable Section

Figure 6-3. Outlet devices

usually constructed of concrete, either cast in place or pre-fabricated. Several boxes must be installed across the width of the wetland to ensure uniform flow through the wetland. Preferred spacing varies from 5 to 10 m (15–30 ft) but may be as much as 15 m (50 ft) on center depending on the width of the wetland cell. Overflow rates should be limited to <math><200\text{ m}^3/\text{m-d}</math> (16,000 gpd/ft²). Drop boxes do require a deep water zone immediately around them to minimize vegetation encroachment. In northern climates, the boxes are more susceptible to freezing than are submerged manifolds.

Debris screens may be placed in front of FWS wetland outlets. In Figure 6-3 there is an example of their placement in the outlet. The emergent vegetation in the wetland will drop many leaves, and storm events can uproot entire plants that float to the collection manifolds or outlet structures. The screens will prevent the debris from clogging the downstream piping or treatment processes or impairing effluent quality.

6.2.1.6 Media

A soil or finer-rock medium is necessary as a matrix in both FWS wetlands and VSB systems for supporting emergent vegetation. In FWS wetlands, a layer of soil at least 15 cm (6 in) deep is placed on the compacted bottom or liner to create the rooting medium for the intended emergent vegetation. This soil can be the topsoil removed during initial site preparation and grading or can be imported. Any loamy soil with acceptable agronomic properties is suitable.

In VSB systems, the media provide the matrix for water flow as well as the planting medium. Gravel is the most commonly used media, but sand, crushed rock, and plastic media also have been used (Kadlec and Knight, 1996). Large gravel media are typically recommended to prevent clogging, whereas a smaller media layer can be used on top of a bed of larger gravel to provide a better rooting media (see Chapter 5).

Most local sand and gravel suppliers have concrete aggregate available that can be screened for the coarse fractions to provide an acceptable media for VSB systems. The media should be washed to eliminate soil and other fines that can contribute to media clogging. Rounded river gravel is recommended over sharp-edged crushed rock because of the looser packing that the rounded rock provides. Hard, durable stone (river gravel or crushed stone) is recommended. Crushed limestone, which is soft and easily disintegrates, should be avoided.

6.2.2 Vegetation Establishment

Vegetation and its litter is necessary for successful performance of FWS wetlands and contributes aesthetically to the appearance of both FWS wetlands and VSB systems. Establishing this vegetation is probably the least familiar aspect of wetland construction for most contractors. In recent years, a number of specialty firms have emerged with the expertise for selecting and planting the vegetation

in these systems. Employing one of these firms is recommended for large projects if the construction contractor does not have prior wetland experience.

6.2.2.1 Species Selection and Sources

For wastewater treatment, macrophytes selected for planting should (1) be active vegetative colonizers with spreading rhizome systems, (2) have considerable biomass or stem densities to achieve maximum velocity gradient and enhanced flocculation and sedimentation, and (3) be a combination of species that will provide coverage over the broadest range of water depths encountered (Allen et al., 1990).

Wetland plants can be purchased from nurseries, collected in the wild, or grown for a specific project. No general recommendation can be made as to the best source of plants for a particular project. However, wild collected plants are usually the most desirable because they are more closely adapted to local environmental conditions, can be planted with limited storage, and offer a greater diversity. For large projects, commercial seedlings may be the most cost-effective alternative. The seedlings are supplied in suitable planting condition that allows use of mechanical agricultural equipment for planting.

6.2.2.2 Planting

Establishing vegetation in a constructed wetland involves planting a suitable propagule at the appropriate time. Whole plants or dormant rhizomes and tubers are typically planted. Seeding has not been particularly successful because of stratification requirements of wetland seed and loss of seed from water action.

In temperate climates, the prime planting period begins after dormancy has begun in the fall and ends after the first third of the summer growing season has passed. The planting period for herbaceous vegetation is broader than for woody plants. Early spring growing-season plantings have been the most successful (Allen et al., 1990).

Planting seedlings or clumps is the simplest method. Some experience is necessary with rhizomes to identify the node of the future shoot, which must be planted upward. Special anchoring may be necessary when the planting medium is soft, plants are buoyant, or erosion will disturb the system. The soil should be maintained in a moist condition after planting. The water level can be increased slowly as new shoots develop and grow. The water level must never be higher than the tips of the green shoots or the plants will die.

The macrophyte planting density can be as close as 0.3 m (1 ft) centers or as much as 1 m (3 ft). The higher the density, the more rapid will be the development of a mature and completely functional wetland system. However, high density plantings will increase construction costs significantly. If planted on 1 m (3 ft) centers, a wetland system will take at least two full growing seasons to approach equilibrium and optimal plant-related performance objec-

tives. FWS wetlands should be planted more densely owing to the role of the plants in the treatment process. However, it may not be economical to plant very large FWS wetlands on 1 m (3 ft) centers if the total wetland area is intended to cover several thousand hectares. In such cases, plantings should be done in separate bands extending the full width of the wetland cells to interrupt preferential flow of wastewater through the cells. VSB systems can be planted less densely.

Water must be provided during the initial growth period. This can be complicated in large FWS wetlands because it may not be possible to plant the entire surface in a cell at one time. If mechanical equipment is used for planting, the unplanted areas should be kept dry until planting is complete. Since the bottom is sloped toward the discharge end, planting should start at the outlet and proceed toward the inlet. Sprinklers and shallow flooding have been used to keep the planted areas wet. If planting by hand, the whole area can be flooded with a few centimeters of water. The water depth can be increased gradually as the plant shoots grow until the design level is reached. If the FWS wetland is designed to treat a high-strength influent such as primary treated wastewater, a cleaner water source or diluting the wastewater with storm water or well water is recommended for the initial planting and growth period so the plants are not overly stressed. If the intended influent is close to secondary quality, it can be used immediately. If an acceptable agronomic soil has not been used as the rooting media, a preliminary application of commercial fertilizers may be necessary. Use of fertilizers should be carefully considered, however, because of the potential impacts of the nutrients that might escape in the effluent to the receiving water.

In VSB systems, it is typical practice to flood the wetland cell to the surface of the media prior to planting and to maintain that level until significant growth has occurred. Later, the water level is lowered to the intended operating level. If the wetland is designed to treat septic tank or primary effluent, clean water is recommended for the planting phase. The high oxygen demand of the wastewater could inhibit initial plant growth. After a few weeks of plant growth, wastewater can be introduced. A layer of straw or hay mulch 15 to 20 cm (6–8 in) in thickness should be placed on the gravel surface to protect the new plants from the high summer surface temperatures that can occur on bare gravel surfaces. The mulch also is useful for providing thermal insulation during the first winter of operation in northern climates.

6.3 Start-up

Start-up periods for FWS wetlands are necessary to establish the flora and fauna associated with the treatment processes. The start-up period will vary in length depending on the type of design (FWS wetlands or VSB systems), the characteristics of the influent wastewater, and the season of year. In FWS wetlands, the start-up period should be sufficient for the vegetation to become well established if the treatment objectives are to be met. The start-up pe-

riod for VSB systems is less critical since its performance is less dependent on vegetation.

6.3.1 Free Water Surface Wetlands

FWS wetlands will not attain optimum performance levels until the vegetation and litter are fully developed and at equilibrium. The time required to reach this point is a function of the planting density and season of the year. A wetland with a high density planting that is started in the spring is likely to be fully developed by the end of the second growing season. A wetland with a low density planting started in late fall in a northern climate may require three years or more to achieve its intended treatment performance.

Under ideal conditions, start-up of a FWS wetland should be delayed six weeks after planting to provide sufficient time for the emergent plants to acclimatize and grow above the working water level. When this is not possible, start-up must control the water level at less than plant height. However, such rapid start-up will risk damage to the new plants and may prolong the time required for the system to reach optimum performance.

When start-up is initiated, the water level must be gradually raised to the design level by adjusting the flow control device at the outlet of each cell. This is done to allow the tops of the emerging vegetation to remain above water. If the influent is high strength, such as primary or septic tank effluent, it may be necessary to dilute the influent with clear water or recycle treated effluent to slowly increase the pollutant loadings to the wetland until the vegetation is acclimatized.

During the start-up period, the operator should inspect the wetland several times per week. Plant health and growth should be observed, berms and dikes inspected for structural problems, water levels adjusted, and mosquito emergence noted. In large areas of a FWS system where growth of the vegetation has failed, the macrophytes should be replanted to avoid the risk of short-circuiting of flow. The experience developed during this period will be helpful in determining the inspection frequency that will be required during the mature phase of the wetland.

Treatment performance during the start-up period may not be representative of long-term expectations. Poorly established FWS wetlands with minimal vegetation will not perform acceptably. Influent TSS and associated pollutants will not be properly removed. Large open areas will permit algae blooms. The system will not perform differently from a maturation pond, in that only pathogen kill will likely occur. Removal efficiency of TSS and its associated pollutants can be expected to improve as the plant canopy develops and increases in density. Removals of ammonia and phosphorus may be greater during the start-up period than after equilibrium is reached in new FWS wetlands, which have a new soil surface and rapidly growing vegetation. Both conditions provide a rapid but short-term removal of these nutrients. Adsorption sites on soil particles

can take up both ammonia and phosphorus, and the nutrient uptake by the plants during the rapid growing phase can be significant. Within one or two years of start-up, however, removal of phosphorus will decline. Removal of ammonia nitrogen will decline also unless the system is a FWS with substantial open areas.

6.3.2 Vegetated Submerged Bed Systems

Treatment in VSB systems is primarily BOD and TSS removal through the trapping of particulate material in the media. Some BOD removal may be reintroduced from biochemical methanogenesis of captured organic solids in the anaerobic environment. Biological denitrification also may occur if nitrates are present in the influent. Plants may take up nutrients in the wastewater, but this is usually not significant. Phosphorus removal during the start-up period will occur, but typically becomes minor as chemical exchange sites on the media are filled. Since the plants play an insignificant role in the treatment performance, equilibrium should be reached in less than one year unless high-capacity media is employed.

During the start-up period, the operator is primarily responsible for adjusting the water level in the wetland. Typically, the VSB systems will be filled to the surface of the media at the end of planting. As the plants begin to root, the water level can be gradually lowered to the design operating level. It may be necessary to add fertilizer during this period until sufficient nutrients are made available by the addition of wastewater.

6.4 Operation and Maintenance

Constructed wetlands are "natural" systems. As a result, operation is mostly passive and requires little operator intervention. Operation involves simple procedures similar to the requirements for operation of a facultative lagoon. The operator must be observant, take appropriate actions when problems develop, and conduct required monitoring and operational monitoring as necessary. The most critical items in which operator intervention is necessary are adjustment of water levels

- Maintenance of flow uniformity (inlet and outlet structures)
- Management of vegetation
- Odor control
- Control of nuisance pests and insects
- Maintenance of berms and dikes

6.4.1 Water Level and Flow Control

Water level and flow control are usually the only operational variables that have a significant impact on a well-designed constructed wetland's performance. Changes in water levels affect the hydraulic residence time, atmospheric oxygen diffusion into the water phase, and plant cover. Significant changes in water levels should be in-

vestigated immediately, as they may be due to leaks, clogged outlets, breached berms, storm water drainage, or other causes.

Seasonal water level adjustment helps to prevent freezing in the winter. In cold climates, the water levels should be raised approximately 50 cm (18 in) in late fall until an ice sheet develops. Once the water surface is completely frozen, the water levels can be lowered to create an insulating air pocket under the ice and snow cover to maintain higher water temperatures in the wetland (Kadlec and Knight, 1996; Grits and Knight, 1990). This procedure is used for both FWS wetlands and VSB systems.

6.4.2 Maintenance of Flow Uniformity

Maintaining uniform flow across the wetland through inlet and outlet adjustments is extremely important to achieve the expected treatment performance. The inlet and outlet manifolds should be inspected routinely and regularly adjusted and cleaned of debris that may clog the inlets and outlets. Debris removal and removal of bacterial slimes from weir and screen surfaces will be necessary. Submerged inlet and outlet manifolds should be flushed periodically. Additional cleaning with a high-pressure water spray or by mechanical means also may become necessary.

Influent suspended solids will accumulate near the inlets to the wetland. These accumulations can decrease hydraulic detention times. Over time, accumulation of these solids will require removal. VSB systems cannot be desludged easily without draining and removing the media. Therefore, VSB systems should not be considered for treating wastewaters with high suspended-solids loads, such as facultative pond effluents, which have high algal concentrations.

6.4.3 Vegetation Management

Routine maintenance of the wetland vegetation is not required for systems operating within their design parameters and with precise bottom-depth control of vegetation. Wetland plant communities are self-maintaining and will grow, die, and regrow each year. Plants will naturally spread to unvegetated areas with suitable environments (e.g., depth within plant's range) and be displaced from areas that are environmentally stressful. Operators must control spreading into open water areas that are intended by design to be aerobic zones through harvesting.

The primary objective in vegetation management is to maintain the desired plant communities where they are intended to be within the wetland. This is achieved through consistent pretreatment process operation, small, infrequent changes in the water levels, and harvesting plants when and where necessary. Where plant cover is deficient, management activities to improve cover may include water level adjustment, reduced loadings, pesticide application, and replanting.

Harvesting and litter removal may be necessary depending on the design of the system. Plant removal from some

FWS wetlands may be required to meet the treatment goals, but a well-designed and well-operated VSB system should not require routine harvesting. Harvesting of Phragmites at the height of the growing season and just before the end of the growing season does help to remove some nitrogen from the system, but phosphorus removal is limited (Suzuki et al., 1985). Winter burning of vegetation can be used to control pests.

6.4.4 Odor Control

Odors are seldom a nuisance problem in properly loaded wetlands. Odorous compounds emitted from open water areas are typically associated with anaerobic conditions, which can be created by excessive BOD and ammonia loadings. Therefore, reducing the organic and nitrogen loadings can control odors. Alternatively, aerobic open water zones interspersed in areas between fully vegetated zones introduce oxygen to the system. Turbulent flow structures such as cascading outfall structures and channels with hydraulic jumps, which are employed to introduce oxygen into the system effluent, can generate serious odor problems through stripping of volatile compounds such as hydrogen sulfide, if the constructed wetland has failed to remove these constituents.

6.4.5 Control of Nuisance Pests and Insects

Potential nuisances and vectors that may occur in FWS wetlands include burrowing animals, dangerous reptiles, mosquitoes, and odors. An infestation of burrowing animals such as muskrats and nutria can seriously damage vegetation in a system. These animals use both cattails and bulrushes as food and nesting materials. These animals can be controlled during the design phase by decreasing the slope on berms to 5:1 or using a coarse riprap. Temporarily raising the operating water level may also discourage the animals. Live trapping and release may be successful, but in most cases it has been necessary to eliminate the animals. Fencing has had little success.

Dangerous reptiles are common in the southeastern states. The most common are snakes, particularly the water moccasin, and alligators. It is difficult to control these animals directly. Warning signs, fencing, raised boardwalks, and mowed hiking trails can be used to minimize human contact with the animals. Operators should be made aware of the dangers and preventive actions that can be taken to avoid dangerous situations.

Mosquito control is a critical issue in FWS wetlands. In warm climates, wetlands have been seeded with mosquito fish (*Gambusia*) and dragonfly larvae to control mosquitoes. Mosquito fish also can be used in northern climates, but they need to be restocked each year. However, mosquito fish have difficulty reaching all parts of the wetland when the accumulation of litter is too dense, particularly if cattails are grown. Other natural control methods have included erecting bat and bird houses. Desirable birds include purple martins and swallows. Bacterial larvicides, BTI (*Bacillus thuringiensis israelensis*), and BS *Bacillus*

sphaericus) have been used successfully in a number of wetlands.

6.4.6 Maintenance of Berms and Dikes

Berms and dikes require mowing, erosion control, and prevention of animal burrows and tree growth. When the wetland is operated at a shallow depth, periodic removal of tree seedlings from the wetland bed may be necessary. If the trees are allowed to reach maturity, they may shade out the emergent vegetation and with it the necessary conditions to enhance flocculation, sedimentation, and denitrification.

6.5 Monitoring

Routine monitoring is essential in managing a wetland system. In addition to regulatory requirements, inflow and outflow rates, water quality, water levels, and indicators of biological conditions should be regularly monitored and evaluated. Monitoring of biological conditions includes measurement of microbial populations and monitoring changes in water quality, percent cover of dominant plant species, and benthic macroinvertebrate and fish populations at representative stations. Over time, these data help the operator to predict potential problems and select appropriate corrective actions.

6.6 References

- Allen, H.H., G.J. Pierce, and R. Van Wormer. 1990. Considerations and techniques for vegetation establishment in constructed wetlands. In: D.A. Hammer (ed.) *Constructed wetlands for wastewater treatment, municipal, industrial and agricultural*. Chelsea, MI: Lewis Publishers, Inc.
- Grits, M.A. and R.L. Knight. 1990. Operations optimization. In: D.A. Hammer (ed.) *Constructed wetlands for wastewater treatment, municipal, industrial and agricultural*. Chelsea, MI: Lewis Publishers, Inc.
- Kadlec, R.H. and R.L. Knight. 1996. *Treatment wetlands*. Boca Raton, FL: CRC Press LLC.
- Rumer and Mitchell, 1996. Assessment of barrier containment technologies. NTIS report # PB 96-180583.
- Suzuki, T., A.G. Wathugala, and Y. Kurihara. 1985. Preliminary studies on making use of *Phragmites australis* for the removal of nitrogen, phosphorus, and COD from the waste water. UNESCO's Man and Biosphere Programme in Japan, Coordinating Committee on MAB Programme, pp. 95-99.
- U.S. Environmental Protection Agency (EPA). 1993. Report of workshop on geosynthetic clay liners. EPA/600/R-93/171. Office of Research and Development, Washington, DC.
- U.S. Environmental Protection Agency (EPA). 1994. Seminar Publication: Design, operation, and closure of municipal solid waste landfills. EPA/625/R-94/008. Office of Research and Development, Cincinnati, OH.

Chapter 7

Capital and Recurring Costs of Constructed Wetlands

7.1 Introduction

The major items included in capital costs of constructed wetlands are

- Land costs
- Site investigation
- Clearing and grubbing
- Excavation and earthwork
- Liner
- Media
- Plants
- Inlet structures
- Outlet structures
- Fencing
- Miscellaneous piping, pumps, etc.
- Engineering, legal, and contingencies
- Contractor's overhead and profit

Most of these costs are directly dependent on the design treatment area of the system, and the unit costs for almost all are essentially the same for FWS and VSB systems. The major difference between the two concepts is the media cost (Table 7-1). In the case of a VSB, a 60 cm (2 ft) depth of gravel typically fills the bed, whereas the medium for a FWS wetland consists of 15 cm (6 in) or more of topsoil used as growth media for the wetland vegetation.

7.2 Construction Costs

7.2.1 Total Construction Costs

The cost data in this report were obtained from site visits to nine operational constructed wetland systems and from related published sources. The nine systems were Arcata, CA; Gustine, CA; Mesquite, NV; Ouray, CO; West Jackson County, MS; Mandeville, LA; Sorrento, LA;

Carville, LA; and Ten Stones, VT. This group includes four FWS wetlands and five VSBs with design flows ranging from 0.3 to 175 L/s (6,700 gpd to 4 mgd). The start-up dates for these subsystems range from 1986 (Arcata, CA) to 1997 (Ten Stones, VT). In order to provide a common base for comparison, all costs have been adjusted with the appropriate Engineering News Record (ENR) Construction Cost Index (CCI) factor to August 1997 (ENR CCI = 5854).

Unfortunately, it is not possible to extract the individual line-item construction costs listed in Table 7-1 for most existing wetland systems because their construction contracts were let as lump sum bids for entire projects. In many cases, the situation is further confounded since the lump sum bids also may include preliminary treatment components, pumping stations, and community collection systems. In addition, local conditions and site characteristics also significantly affect wetland system costs. VSB wetlands in southern Louisiana, for example, pay a high price for imported gravel since none is available locally. Some existing wetland systems were converted from existing lagoon cells. In these cases, the costs for clearing and grubbing and excavation and earthwork would be minimal. As a result of these factors, it is not possible to derive general nationally applicable cost-per-hectare unit cost. The best that can be achieved is a range of costs that may be useful for an order-of-magnitude preliminary estimate.

Table 7-2 presents a summary of technical and cost data for the nine constructed wetland systems included in the EPA case study visitations. The costs listed in the table are the estimated construction costs for the wetland component in each system at the time the system was constructed. It is difficult to draw general conclusions from the data because of the many variables involved. The systems listed were designed with different design models and procedures to achieve different water quality goals, so the relationship between the treatment areas provided and the design flow rates is not meaningful. The only nearly consistent factor is that land costs were zero in all cases except Ouray, CO, because the land was already in the possession of the system owner. The costs given are based on actual construction costs and do not include a factor for system design or site investigation. In most cases, the site investigation costs for these nine systems were minimal

Table 7-1. Cost Comparison of 4,645 m² Free Water Surface Constructed Wetland and Vegetated Submerged Bed

Item	Units	Unit Price	Free Water Surface Wetland		Vegetated Submerged Bed	
			Total Cost (\$)	% of Total	Total Cost (\$)	% of Total
Excavation/Compaction	m ³	\$2.30	13,000	19.4	13,000	10.7
Soil (45 cm)	m ³	\$1.30	2,800	4.2	na	—
Gravel (60 cm)	m ³	\$20.95	Na	—	51,900	42.6
Liner (30 mil PC)	m ²	\$3.75	19,250	28.7	19,250	15.8
Plants	Each	\$0.60	7,500 (60 cm o.c.)	11.2	13,330 (45 cm o.c.)	10.9
Plumbing	Lump sum		7,500	11.2	7,500	6.1
Control Structures	Lump sum		7,000	10.4	7,000	5.7
Other	Lump sum		10,000	14.9	10,000	8.2
			67,050	100.0	121,980	100.0

* 4,645 m² = 50,000 ft²

Table 7-2. Technical and Cost Data for Wetland Systems Included in 1997 Case Study Visitations

Location	Startup Date	Area (hectares)	Flow (m ³ /s)	No. Cells	Liner ¹	Berm Const ²	Land Cost	Const. Cost	\$/m ²	Adj. Cost ³ \$/m ²
Free Water Surface Wetlands										
Arcata, CA	1986	3.0	66.2	3	No	No	\$0	\$225,000	7.43	10.12
Gustine, CA	1987	9.8	22.8	24	No	Yes	\$0	\$882,000	9.04	12.27
Ouray, CO	1993	0.9	8.7	4	Yes	Yes	\$55,000	\$108,500	12.16	13.02
W.J.C. MS	1997	20.2	54.8	7	No	Yes	\$0	\$700,000	3.44	3.44
Vegetated Submerged Beds										
Carville, LA	1986	0.3	3.4	1	No	Yes	\$0	\$100,000	38.64	52.64
Mandeville, LA	1990	2.3	34.2	3	No	No	\$0	\$590,000	26.05	32.18
Mesquite, NV	1991	1.9	9.1	12	No	No	\$0	\$515,000	27.13	32.83
Sorrento, LA	1991	0.07	1.14	1	No	Yes	\$0	\$75,000	103.44	125.18
Ten Stones, VT	1997	0.04	0.16	2	Yes	Yes	\$0	\$40,000	84.66	89.66

¹A 'No' response is compacted native soil or pre-existing pavement

²A 'No' response had pre-existing lagoon berms

³Adjusted to August, 1997 costs (ENR CCI = 5854)

Hectares = 2.47 acres; m³/s = 22.83 mgd; m² = 10.76 ft²

since information pertaining to soil characteristics and ground water conditions was already available.

There is some evidence of economy of scale in the tabulated data; the 20.2-hectare (50-acre) FWS wetland expansion at West Jackson County, MS, is the largest system listed and had the lowest unit cost. Contributing factors are believed to be the lack of a liner and minimal berm construction because of the small number of relatively large cells selected for this project (seven cells). Ouray, CO, had the highest unit costs listed for FWS wetlands. This system required the use of a membrane liner and had significant construction costs for berms because of the number of small cells, in this case four cells on 0.89 hectares (2.2 acres). The system at Gustine, CA, shows a higher unit cost than Arcata, CA, primarily due to the extra berm construction involved. Other sources indicate that the cost per hectare for

large FWS systems is about one-third the cost of smaller FWS wetlands, similar to the range presented in Table 7-2. The construction costs for FWS wetlands might therefore range from about \$34,600 per hectare to \$237,200 per hectare (\$14,000/acre to \$96,000/acre in 1997\$), depending on the size of the system, the number of cells and berms, and the need for a membrane liner. The size of the system will depend on the water-quality goals and local climatic conditions. Additional costs will include any site investigation and engineering design, pre- and/or post-treatment components, means for transferring wastewater to the treatment site and effluent from the site, and land costs.

Economy of scale is apparent for the five VSB systems listed in Table 7-2. The average unit cost for the two smallest systems is at least twice that of the three larger systems. An-

other major factor in these cost differences is due to the significant differences in the local costs of the rock and gravel media used. Sorrento, LA, for example, used crushed limestone imported from Mexico because specified aggregate was not available in that part of Louisiana. In comparison, Mesquite, NV, used available media from a nearby gravel pit. Local gravel also was available for the Ten Stones, VT, system, but the system is conservatively designed for the cold winter climate and has a higher unit cost than Mesquite, NV. If the Sorrento costs are omitted, the construction costs for VSB wetlands may range from \$321,200 per hectare to \$897,000 per hectare (\$130,000/acre to \$363,000/acre in 1997\$), depending on the size of the system, the need for a liner, and the local costs of gravel. The size of the system will depend primarily on the water-quality goals and to a lesser degree on local climatic conditions. Additional costs will include any site investigation and engineering design, pre- and/or post-treatment components, means for transferring wastewater to and/or from the treatment site, and land costs. These costs for VSB wetlands are significantly higher than the highest costs cited for FWS wetlands.

7.2.2 Geotechnical Investigations

Only four of the systems listed in Table 7-2 did not utilize any preliminary geotechnical investigations. Three of these, Arcata, CA; Gustine, CA; and Mesquite, NV, utilized existing lagoon cells, and the underlying soil conditions were presumably already known. The fourth system, Ten Stones, VT, was relatively small, and the state regulatory agency required a membrane liner regardless of the underlying soil characteristics, so a geotechnical investigation was not considered necessary. The other five systems utilized some shallow borings to verify expected soil conditions at

the wetland site. The only system that retained cost data for this activity was Mandeville, LA, where approximately \$15,000 was allocated in 1989 for site surveys and soil borings in the wetland area. The updated cost for surveying and soil borings at the Mandeville wetland site would be about \$2,720 per hectare (\$1,100/acre) in 1997\$.

7.2.3 Clearing and Grubbing

Three of the systems listed in Table 7-2 required clearing and grubbing as part of their site preparation. Technical details and related costs are listed in Table 7-3. The cost data in Table 7-3 are compatible with experience in the general construction industry. Costs for clearing and grubbing on relatively level land can range from \$4,940 per hectare (\$2,000/acre) for brush and some small trees to \$12,355 per hectare (\$5,000/acre) for a tree-covered site. Campbell and Ogden (1999) indicate southwestern costs at \$2,965 per hectare (\$1,200/acre).

7.2.4 Excavation and Earthwork

Excavation and earthwork typically includes grading the wetland site to finished grade, constructing berms and access ramps, and in the case of FWS wetlands, reserving and replacing topsoil in the bed to serve as the vegetation growth medium. Table 7-4 summarizes available cost data from the 1997 survey.

An economy of scale is expected for earthwork costs and is evident in the data for the small Ten Stones, VT, project where excavation costs were three times greater than the larger municipal-sized systems. All three sites listed were on relatively level land, with soils ranging from clay at West Jackson County, MS, to silty loam at Ten Stones, VT. The average cost for the two municipal sys-

Table 7-3. Clearing and Grubbing Costs for EPA Survey Sites

Location	Site Area (hectares)	Total Cost	Cost/Hectare	Adj. Cost ¹ (\$/hectare)
West Jackson Co., MS ²	20.2	\$100,000	\$4940	4940
Sorrento, LA ³	1.6	\$7,000	\$4325	5235
Ouray, CO ⁴	2.0	\$22,700	\$11,120	12,050

¹Adjusted to August, 1997 \$ (ENR CCI = 5854)
²Ground cover: brush and sparse tree seedlings
³Ground cover: brush
⁴Ground cover: trees
 Hectares = 2.47 acres

Table 7-4. Excavation and Earthwork Costs for EPA Survey Sites

Location	Site Area (hectares)	Quantity (m ³)	Total Cost	\$/Hectare	\$/m ³	Adj. Cost ¹ (\$/m ³)
W. Jackson Co., MS	20.2	52,000	\$408,000	20,165	7.85	8.29
Gustine, CA	9.7	34,400	\$200,000	20,600	5.81	8.03
Ten Stones, VT	0.04	355	\$8,200	184,200	23.16	23.16

¹Adjusted to August, 1997 \$ (ENR CCI = 5854)
 Hectares = 2.47 acres
 m³ = 1.31 yd³

tems shown is about \$8.17 per cubic meter (\$6.25/yd³). About one-third of that cost could be assigned to excavation of the wetland bed to grade (on relatively level land), with the remainder for berm and ramp construction and reservation and replacement of topsoil for the FWS system. Campbell and Ogden (1999) suggest \$1.96 to \$3.27 per cubic meter (\$1.50 to \$2.50/yd³) as a default value for preliminary estimates.

7.2.5 Liner Costs

A variety of materials, including the in situ native soils, have been used as liner material depending on the requirements of the regulatory agencies. The majority of the systems listed in Table 7-2 utilized the existing on-site soils for their liner material. Two of the remaining systems listed in Table 7-2 used plastic membrane liners. Table 7-5 summarizes these costs. These costs reflect the economy of scale available for larger systems. The unit cost at Ouray was \$5.27 per m² (\$0.49/ft²), while \$10.01 per m² (\$0.93/ft²) was found at Ten Stones (1997\$). Ouray used a 30-mil HDPE liner, and Ten Stones used a prefabricated 30-mil PVC liner. Other liner materials are also available, and typical large system costs for some of these are presented in Table 7-6. Where soils are rocky, a geotextile fabric or layer of sand may be necessary beneath the synthetic liner to protect it from punctures. The liner will add \$0.54 to \$0.86/m² (\$0.05 to \$0.08/ft²) to the costs presented in Table 7-6. The costs of compaction and testing of clay liners can exceed \$3.23/m² (\$0.30/ft²).

Table 7-5. Liner Costs for EPA Survey Sites

Location	Treatment Area (hectares)	Total Cost	Cost/ Hectare ¹	Adj. Cost ² (\$/hectare)
Ouray, CO	1.36 ³	\$64,000	\$46,930	52,725
Ten Stones, VT	0.045	\$4,500	\$100,175	100,175

¹Represents cost per hectare of treatment area. Actual liner area is larger to cover berms, etc.

²Adjusted to August, 1997 \$ (ENR CCI = 5854)

³Lined area at Ouray, CO includes lagoons and wetland cells. Hectares = 2.47 acres = 10,000 m²

Table 7-6. Typical Installed Liner Costs for 9,300 Square Meter (100,000 ft²) Minimum Area

Liner Material	\$/m ²
Bentonite (9.8 kg/m ² and harrowed in place)	0.52-0.60
Clay impregnated geosynthetic	0.37-0.60
Asphalt concrete	0.60-0.75
Butyl rubber (50 mm thickness)	0.60
PVC (30 mil)	0.28-0.40
HDPE (40 mil)	0.35-0.40
Hypalon (30 mil)	0.55
Hypalon (60 mil)	0.60-0.70
PPE (30 mil)	0.58-0.60
Reinforced PPE (30 mil)	0.65
XR-5	0.85-0.92

m² = 10.76 ft²

7.2.6 Media Costs

The media in a FWS wetland are the soils placed on top of the prepared bottom of the bed which serve as the growth medium for the emergent vegetation in the system. A similar layer of topsoil is also usually applied to the berm slopes to allow their revegetation. Placement of these soil layers is usually included in the earthwork costs previously discussed.

The media used in a VSB are the gravel or rock placed in the bed. They serve to support the growth of the vegetation and to provide physical filtration, flocculation, sedimentation, and surfaces for attached microbial growth and adsorption to occur. Several different sizes of rock and gravel can be used in these systems. At the sites visited in the EPA study, medium-sized gravel, 20–25 mm in diameter (0.75–1 in), was used for treatment. Coarser rock, 40–50 mm in diameter (1.5–2 in), was used to surround the inlet and outlet manifolds, and a layer of pea gravel, 5–10 mm in diameter (1/4–3/8 in), was sometimes used to cap the gravel in the treatment bed. Coarse stone, 10–15 cm in diameter (4–6 in), is sometimes used to cover the exposed liner on the side slopes and to reduce the risk of burrowing animals. The unit cost of these materials depends on the size of the material, the volume needed, and the distance from the source to the wetland site. The media is usually the most expensive part of the construction of a VSB, potentially representing 40 to 55% of total construction costs (Table 7-1). Table 7-7 summarizes the costs for these materials as derived from the 1997 site visitations.

The local availability of gravel and the transport distance to the VSB site are the key factors influencing media costs. As a result, the cost data in Table 7-7 should only be used for preliminary estimates. Local sources should be contacted for a detailed construction cost estimate. Based on the data in Table 7-7, the media costs (for the main bed) range from \$74,130 to \$133,440 per hectare (\$30,000 to \$54,000/acre) depending on the local availability of suitable material.

7.2.7 Plants and Planting Costs

Plant materials sometimes can be obtained locally by cleaning drainage ditches. It is also possible to develop an on-site nursery at the wetland construction site if there is sufficient advance time, or grow plant sprigs or seedlings from seed and transplant these to the wetland cells. A large and expanding number of commercial nurseries also exist and can supply a large variety of plant species for these wetlands systems. The majority of the systems listed in Table 7-2 were planted with commercial nursery stock. Small systems are typically planted by hand; large systems can use mechanical planters, and nursery-grown sprigs or plant seedlings are advantageous for the purpose. Hydroseeding has been successful with *Typha* seeds (Gearheart et al., 1998). Table 7-8 summarizes available cost data for plants and planting from the 1997 survey sites. Campbell and Ogden (1999) quote a range of \$0.50 to \$1.00 per plant in place as a default value, while Gearheart et al. (1998) estimate \$12,355 per hectare (\$5,000/acre) for a total planting cost.

Table 7-7. Media Costs for VSBs from EPA Survey Sites

Location	Media Size (mm)	Media Depth (m)	Media Quantity (m ³ /hectare)	Cost (\$/m ³)	Cost (\$/hectare)	Adj. Cost ¹ (\$/hectare)
Mesquite, NV Carville, LA	Bed: 10-25	0.8	8,140	10.99	89,380	108,230
	Top: 20	0.15	1,525	27.14	41,325	44,735
Ten Stones, VT	Bed: 40-75	0.60	6,100	20.21	123,160	133,320
	Top: 10	0.15	1,523	25.07	38,180	38,180
	Bed: 20-25	0.60	6,095	12.01	73,180	73,180
	Outlets: 50	0.60	725	7.85	5,680	5,680
	RipRap: 100	0.12	445	18.31	8,130	8,130

¹Adjusted to August, 1997 \$ (ENR CCI = 5854)
m³/hectare = 1.89 yd³/acre

Table 7-8. Costs for Wetland Vegetation and Planting from EPA Survey Sites

Location	Plant Type	Plant Density (no./hectare)	Planting Method	Plant Cost (\$/plant)	Planting Cost (\$/hectare)	Adj. Planting Cost ¹ (\$/hectare)
Ten Stones, VT	Cattails	35,830	Hand	0.23	Not available	Not available
	Bulrush	35,830	Hand	0.23	Not available	Not available
Mandeville, LA	Bulrush	15,000	Hand	Not available	2,965	3,670
Carville, LA	Pickereel Weed	34,595	Hand	Local sources	2,470	3,370
	Arrowhead	34,595	Hand	Local sources	2,470	3,370
Sorrento, LA	None	None	None	None	None	None
Gustine, CA	Bulrush	46,950	Mechanical	Not available	3,460	4,595
	Cattails	11,860	Mechanical	Not available	1,975	2,695
Ouray, CO	Cattails	13,465	Hand	Local sources	Not available	Not available
	Bulrush	13,465	Hand	Local sources	Not available	Not available
West Jackson Co., MS	Cattails	11,860	Mechanical	0.38	4,450	4,450
Mesquite, NV	Bulrush	Not available	Hydroseeding	Not available	Not available	Not available
Arcata, CA	Bulrush	9,885	Hand	Not available	Not available	Not available

¹Adjusted to August, 1997 costs (ENR CCI = 5854)

Table 7-9. Costs for Inlet and Outlet Structures from EPA Survey Sites

Location	Structure Type	Weir Type	Cost (\$/structure)	Adj. Cost ¹ (\$/structure)
West Jackson Co., MS	Concrete box	Bolted plate	2,500	2,500
Carville, LA	Concrete box	Shear Gate	3,900	4,400
Gustine, CA	Concrete box	Stop log	1,125	1,500
Ten Stones, VT	100 mm PVC manifold	None	1,500	1,500

¹Adjusted to August, 1997 \$ (ENR CCI = 5854)

7.2.8 Cost of Inlet and Outlet Structures

The inlet and outlet structures for most small- to moderate-sized wetland systems are typically some variation of a perforated manifold pipe. Large wetland systems typically use multiple drop or weir boxes for both inlets and outlets. Adjustable water level outlet structures should be used to control the water level in the wetland cell. If the outlet is a pipe manifold, a water level-control structure

must be added, which should cost about the same as a weir box. Table 7-9 summarizes the available cost data from the 1997 survey.

7.2.9 Piping, Equipment, and Fencing Costs

These items include the piping to transfer the wastewater to the wetland, the piping from the wetland to a dis-

charge point, and any pumps required for either of those purposes. Fencing is typically installed around all municipal wastewater treatment systems, but has not usually been required around the smaller VSB wetland beds due to the low risk of public contact and exposure to the wastewater. None of these features are unique to wetland systems, and costs for these items were not available at the sites included in the 1997 EPA survey.

7.2.10 Miscellaneous Costs

These costs include engineering design and legal fees, construction contingencies, and profit and overhead for the construction contractor. These costs are not unique to wetland systems and are usually expressed as a percentage of the total construction costs when preparing an estimate. Mobilization and bonding are also typically included in the construction costs. Typical values for miscellaneous costs are as follow:

- Mobilization, 5% of direct costs
- Bonds, 3% of direct costs
- Engineering design services, 15% of capital costs
- Construction services and start-up, 10% of capital costs
- Contractor's overhead and profit, 15% of capital costs
- Contingencies, 15% of capital costs

The following example illustrates the application of these factors. Assume direct project construction costs (i.e., labor, materials, equipment, etc.) are \$300,000, therefore:

• Direct construction costs	\$300,000
• Mobilization, 5%	\$15,000
• Bonds, 3%	\$9,000
• Capital cost of construction	\$324,000
• Engineering, 15%	\$48,600
• Start-up, 10%	\$32,400
• Overhead, profit and contingencies, 30%	\$97,200
• Total capital costs	\$502,200

7.2.11 Construction Cost Summary

The major cost factors for both VSB and FWS wetlands are compared in Table 7-10. The tabulated data are drawn from previous tables for an assumed 0.405 hectare (one acre) wetland with a membrane liner. The cost data are in terms of dollars per hectare, and the percentage data are percent of total cost. The latter can be used to determine which system components are likely to be the most expensive. The cost data shown do not include the costs of the land, mobilization, fencing, landscaping, pre- or post-treatment units, or the transfer piping to and from the wetland site, and should only be used for preliminary, order-of-magnitude cost estimates.

The cost of gravel media for the VSB is the most expensive item in Table 7-10, followed by the membrane liner for both types of wetlands. The cost of the gravel media in the VSB controls the cost regardless of the type of liner used. If site conditions allow for the compaction of native clay soil to produce an acceptable ground water barrier in lieu of a synthetic membrane liner, then the liner costs can be eliminated. In this case, perforated pipe manifolds for inlet and outlet structures are used instead of concrete weir boxes.

7.3 Operation and Maintenance Costs

The operation and maintenance of constructed wetland systems designed for wastewater treatment are relatively simple and require minimal time. They are similar to, but somewhat more than, the O&M requirements for a facultative pond. Most of the operator's time at a wetland treatment system is spent servicing pumps, headworks, disinfection, and other conventional components in the process. Animal (i.e., nutria, muskrats) control, vector (mosquitoes) control, and NPDES monitoring are probably the most time-consuming aspects of wetland operation and maintenance. Crites and Ogden (1998) report the operating costs for FWS constructed wetlands and VSBs range from \$0.10 to \$0.30 and \$0.04 to \$0.08, respectively, per 3,785 L (1,000 gal) of treated water.

At the FWS wetland system at Ouray, CO, the O&M requirements for the wetland are as follows:

• Check berms for animal damage and erosion	Once per week
• Check and clean effluent debris screens	Once per week
• Observe and adjust water levels and flow rates	Once per month
• Remove sludge from inlet zone	As required
• Flush manifold pipes	As required
• Mosquito control	As required by local health authorities

The 1997 monthly operating costs for the complete treatment system (aerated lagoon, FWS, chlorination/dechlorination) at Ouray, CO, were

• Power for lagoon aerators	\$1,400
• Lagoon sludge removal and disposal	800
• Miscellaneous supplies	125
• NPDES laboratory tests	300
• Wages	1,083
• Total	\$3,708

Table 7-10. Range of Capital Costs for a 0.4 Hectare (Membrane Lined VSB and FWS Wetland)

Item	Vegetated Submerged Bed (VSB)				Free Water Surface (FWS)			
	Low Cost Range		High Cost Range		Low Cost Range		High Cost Range	
	Cost ¹ (\$/hectare)	Percent of Total	Cost ¹ (\$/hectare)	Percent of Total	Cost ¹ (\$/hectare)	Percent of Total	Cost ¹ (\$/hectare)	Percent of Total
Survey/Geotechnic	2,718	1.2	5,436	1.3	2,718	1.9	5,436	2.1
Clear & Grub ²	4,942	2.2	12,355	3.0	4,942	3.4	12,355	4.8
Earthwork ³	18,039	8.1	29,900	7.3	18,039	12.4	29,900	11.7
Membrane Liner⁴								
30 mil PVC	37,807	16.9	43,243	—	37,807	26.1	43,243	—
40 mil PE	43,243	—	48,432	—	43,243	—	48,432	—
40 mil PPE	53,869	—	59,305	—	53,869	—	59,305	—
45 mil Reinf. PPE	64,494	—	69,931	—	64,494	—	69,931	—
60 mil Hypalon	69,931	—	80,803	—	69,931	—	80,803	—
XR-5	102,301	—	113,174	27.5	102,301	—	113,174	44.4
Media	129,483 ⁵	57.8	199,413 ⁵	48.5	16,062 ⁶	11.1	20,015 ⁶	7.8
Plants & Planting ⁷	8,649	3.9	17,297	4.2	8,649	6.0	17,297	6.8
Control Structures	4,942 ⁸	2.2	16,062	3.9	39,537 ⁹	27.3	39,600	15.5
Plumbing & Fencing	17,297	7.7	17,297	4.2	17,297	11.9	17,297	6.8
Totals:	233,877¹⁰	100	410,935¹¹	100	145,050¹⁰	100	255,012¹¹	100

¹Adjusted to 1997 dollars (ENR CCI = 5854)²Clearing and grubbing costs are higher for sites with large trees³Earthwork (excavation and compaction) costs are typically 2.00 to 3.25 per m³. A 0.9 m deep excavation was assumed.⁴For rocky soils, add 5,435 to 8,645 per hectare to the costs presented. For a site employing a minimum of 9,300 m² of liner, deduct 5,435. Delete the costs for the liner if native clay liner is used.⁵Reported cost range is for 60 cm of gravel media with 15 cm of pea gravel. Gravel costs typically range from 17 to 26 per m³ within 20 miles of the project. Longer delivery distances will increase the cost.⁶Assumes 15 cm of topsoil over the wetland bottom.⁷Planting costs are typically 0.50 to 1.00 per plant. Values shown are for planting at 2.5 sq. ft centers. Adjust cost if different spacing is used.⁸122 m of 100 mm diameter PVC manifold plus one water level control box⁹Eight concrete weir box structures for inlets/outlets¹⁰Uses 30 mil PVC liner¹¹Uses XR-5 liner
0.405 ha = 1 acre

The tasks specifically related to the wetland components are estimated to require about 16 hours per month or about \$3,000 per year. On an areal basis, this equates to \$3,370 per hectare per year (\$1,364/acre per year) for this 0.89-hectare (2.2-acre) wetland system. These wetland costs represent about 7% of the total O&M costs for the entire treatment process. If more rigorous testing than the minimal NPDES testing were required, then monitoring could become the most expensive cost of all O&M categories shown.

The annual O&M expenses at the VSB system in Carville, LA (0.15 mgd), are shown in Table 7-11. At Carville, the annual costs directly associated with the wetland components are estimated to be \$650 per year or \$2,500 per hectare per year (\$1,015/acre per year). These costs are about 6% of the total O&M costs for the entire treatment system.

The 1996 O&M costs for the Gustine, CA, sewer department were about \$433,275, which included bond repayment, engineering fees, and other contractual services. A single major expense was \$152,402 for electrical power for pumps and the lagoon aerators. The direct O&M costs for the sewer system, the lagoons, and the wetland were \$280,873. Since the wetland O&M tasks at Gustine are similar to those previously described for Ouray and Carville, it can be assumed that the cost percentage determined at those systems is also applicable at Gustine. Using a 7% factor, the annual wetland O&M costs at Gustine would be \$19,661 or approximately \$2,025 per hectare per year (\$819/acre per year).

At Arcata, CA, it is estimated that the O&M tasks directly related to the wetlands require 20 minutes of operator time per day or 122 hours per year. The major tasks are weir adjustments and berm inspections. At an assumed cost of \$30 per hour (including benefits, incidentals, and support costs), the annual O&M costs for the Arcata wetlands would be \$1,205 per hectare per year (\$488/acre per year).

For the small system at Ten Stones, VT (6,700 gpd), one-half hour per month is estimated to inspect the system and pumps and to adjust water levels if necessary. These efforts will be voluntary on the part of the corporation members, so there will be no actual cost for the service. However, if a contractual service were retained at the previously assumed rate of \$30 per hour, the annual maintenance costs would be \$4,043 per hectare per year (\$1,636/acre per year).

The remainder of the systems included in the 1997 EPA Survey (West Jackson County, MS; Mandeville, LA; Mesquite, NV; and Sorrento, LA) did not have recorded data for separate wetland O&M costs, and estimates were not provided. Table 7-12 summarizes the O&M cost data that was available.

It is not possible to divide the total annual O&M costs shown in Table 7-12 into ranked categories for the major O&M tasks. The major O&M tasks are visual inspections of the berms and of plant health, and adjustments in water levels and other flow-control structures as required. Both nutria and musk-

Table 7-11. Annual O&M Costs at Carville, LA (570 m³/d) Vegetated Submerged Bed

Item	Annual Cost (1997 \$)
Electricity	
Lagoon aerators	4,080
UV disinfection	316
Miscellaneous	350
Maintenance	
Repair berms (30 man-hours)	478
Maintain UV system (60 man-hours)	956
Berm grass cutting (50 man-hours)	797
Parts & Supplies	
Aerators	230
UV System	800
Flow meter	25
NPDES Monitoring	
Labor (192 man-hours)	3,209
Materials	350
Total	11,591

Table 7-12. Annual O&M Costs for Constructed Wetlands

Location	Design Flow (m ³ /d)	Treatment Area (hectares)	Cost (\$/ha-yr) ¹
Ouray, CO (FWS)	1375	0.89	3370
Gustine, CA (FWS)	3785	9.71	2025
Ten Stones, VT (VSB)	25	0.05	4045
Carville, LA (VSB)	565	0.26	2510

¹1997 \$

rats can cause physical damage and leakage in the berms and can destroy, as well as some insects, the plant cover in the wetland cells. If routine visual observations indicate damage, a more intense O&M effort will be necessary for repair and animal or insect control.

Active mosquito control may be an issue in California and in the southwestern and southeastern states, and the FWS system O&M costs will increase accordingly. None of the systems listed in Table 7-12 were making special efforts for either animal or mosquito control. On a long-term basis, it will be necessary to remove accumulated sediment from the wetland cells when it begins to interfere with the hydraulic performance of the system. A ramp for this purpose should be included in the design and construction of each wetland cell.

7.4 References

- Campbell, C.S. and M.H. Ogden. 1999. Constructed wetlands in the sustainable landscape. New York, NY: John Wiley and Sons.
- Crites, R.W. and M.H. Ogden. 1998. Costs of constructed wetlands systems. Presented to WEFTEC, WEF 71st Annual Conference, Orlando, FL.
- Gearheart., R.A., B.A. Finney, M. Lang, and J. Anderson. 1998. A comparison of system planning, design, and sizing methodologies for free water surface constructed wetlands. In: 6th International Conference on Wetland Systems for Water Pollution Control. IAWQ.
- Middlebrooks, E.J., C.H. Middlebrooks, J.H. Reynolds, G.Z. Watters, S.C. Reed, and D.B. George. 1982. Wastewater stabilization lagoon design, performance, and upgrading. New York, NY: Macmillan Publishing Co.

Chapter 8 Case Studies

In 1997, a series of site visits to constructed treatment wetlands was performed for the U.S. EPA to compile background information and assess performance of free water surface (FWS) and vegetated submerged bed (VSB) wetlands. Edited versions of these site visit reports are presented in this chapter to enrich the reader's understanding with insight gained from actual construction and operation of treatment wetland systems. Most quantifying terms are expressed in English units. Conversion factors are as follows:

- 1 acre = 0.405 ha
- 1 mgd = 3,780 m³/d
- 1 ft = 0.3 m
- 1 gal/day-ft² = 4 cm/d = 0.004 m³/m²-d
- 1 in = 2.54 cm
- 1 lb = 0.454 kg

8.1 Free Water Surface (FWS) Constructed Wetlands

8.1.1 Arcata, California

8.1.1.1 Background

Arcata is located on the northern coast of California about 240 miles north of San Francisco. The population of Arcata is about 15,000. The major local industries are logging, wood products, fishing, and Humboldt State University. The FWS constructed wetland located in Arcata is one of the most famous in the United States.

The community was originally served, starting in 1949, with a primary treatment plant that discharged undisinfected effluent to Arcata Bay. In 1957, oxidation ponds were constructed, and chlorine disinfection was added in 1966. In 1974, the State of California prohibited discharge to bays and estuaries unless "enhancement" could be proven, and the construction of a regional treatment plant was recommended. In response, the City of Arcata formed a Task Force of interested participants, and this group began research on lower-cost alternative treatment processes using natural systems. From 1979 to 1982, research conducted at pilot-scale wetland units confirmed their capabil-

ity to meet the proposed discharge limits. In 1983, the city was authorized by the state to proceed with development, design, and construction of a full-scale wetland system. Construction was completed in 1986, and the system has been in continuous service since that time.

The wetland system proposed by the city was unique in that it included densely vegetated cells dedicated for treatment followed by "enhancement" marsh cells with a large percentage of open water for final polishing and habitat and recreational benefits. This combined system has been successful since start-up and has become the model for many wetland systems elsewhere.

Two NPDES permits are required for system operation: one for discharge to the enhancement wetlands for protection of public access and one for discharge to the bay. The NPDES limits for both discharges are BOD 30 mg/L and TSS 30 mg/L, pH 6.5 to 9.5, and fecal coliforms of 200 CFU/100 mL. Since public access is allowed to the enhancement marshes, the state required disinfection prior to transfer of the pond/treatment marsh effluent. The state then required final disinfection/dechlorination prior to final discharge to Arcata Bay. The effluent from the final enhancement marsh is pumped back to the treatment plant for this final disinfection step.

The basic system design for the treatment and enhancement marshes was prepared by Dr. Robert Gearheart and his colleagues at Humboldt State University. The design was based on experience with the pilot wetland system that was studied from 1979 through 1982.

The pilot wetland system included 12 parallel wetland cells, each 20 ft wide and 200 ft long (L:W 10:1), with a maximum possible depth of 4 ft. These were operated at variable hydraulic loadings, variable water depths, and variable initial plant types during the initial phase of the study. Hardstem bulrush (*Scirpus validus*) was used as the sole type of vegetation on all cells. The inlet structure for each cell was a 60° V-notch weir, and the outlet used an adjustable 90° V-notch weir, permitting control of the water depth. Heavy clay soils were used for construction of these cells, so a liner was not necessary and seepage was minimal. The second phase of the pilot study focused on the influence of open water zones, plant harvesting, and kinetics optimization for BOD, TSS, and nutrient re-

removal. Some of the cells, for example, were subdivided into smaller compartments with baffles and weirs along the flow path. The results from these pilot studies not only provided the basis for full-scale system design but have contributed significantly to the state-of-the-art for design of all wetland systems.

The full-scale treatment wetlands, with a design flow of 2.9 mgd, utilize three cells operated in parallel. Cells 1 and 2 have surface areas of about 2.75 acres each (L ≈ 600 ft, W ≈ 200 ft), and cell 3 is about 2.0 acres (L ≈ 510 ft, W ≈ 170 ft). The original design water depth was 2 ft, but at the time of the 1997 site visit for this report they were being operated with a 4-ft depth. Hardstem bulrush was again used as the only plant species on these treatment marshes. Clumps of plant shoots and rhizomes were hand planted on about 1-m centers. Since nutrient removal is not a requirement for the full-scale system, the treatment marshes could be designed for a relatively short detention time primarily for removal of BOD and TSS. The HDT in these three cells is 1.9 d at design flow and a 2-ft water depth. These treatment marshes were designed to produce an effluent meeting the NPDES limits for BOD and TSS (30/30 mg/L) on an average basis. These wetland cells utilized the bottom area of former lagoon cells. A schematic diagram of the operating system is shown in Figure 8-1.

The final "enhancement" marshes were intended to provide for further effluent polishing and to provide significant habitat and recreational benefits for the community. These

three cells are operated in series at an average depth of 2.0 ft and have a total area of about 31 acres. Retention time is about 9 d at average flow rates. The first cell (Allen Marsh), completed in 1981, was constructed on former log storage area and contains about 50% open water. The second cell (Gearheart Marsh), completed in 1981, was constructed on former pasture land and contains about 80% open water. The third cell (Hauser Marsh) was constructed in a former borrow pit and contains about 60% open water. These 31 acres of constructed freshwater (effluent) marshes have been supplemented with an additional 70 acres of salt water marshes, freshwater wetlands, brackish ponds, and estuaries to form the Arcata Marsh and Wildlife Sanctuary, all of which has been developed with trails, an interpretive center, and other recreational features. The shallow water zones in these marshes contain a variety of emergent vegetation. The deeper zones contain submerged plants (Sago pondweed) that provide food sources for ducks and other birds and release oxygen to the water to further enhance treatment.

The construction costs for the entire system, including modifications to the primary treatment plant, disinfection/dechlorination, pumping stations, and so forth were \$5,300,000 (1985\$). Construction costs for the treatment wetlands are only estimated to be about \$225,000, or \$30,000 per acre, or \$78 per 1000 gpd of design capacity (including removal of sludge from this site, which was previously a sedimentation pond for an aerated lagoon). This does not include pumping costs to transfer final effluent back to the chlorination contact basin, disinfection facili-

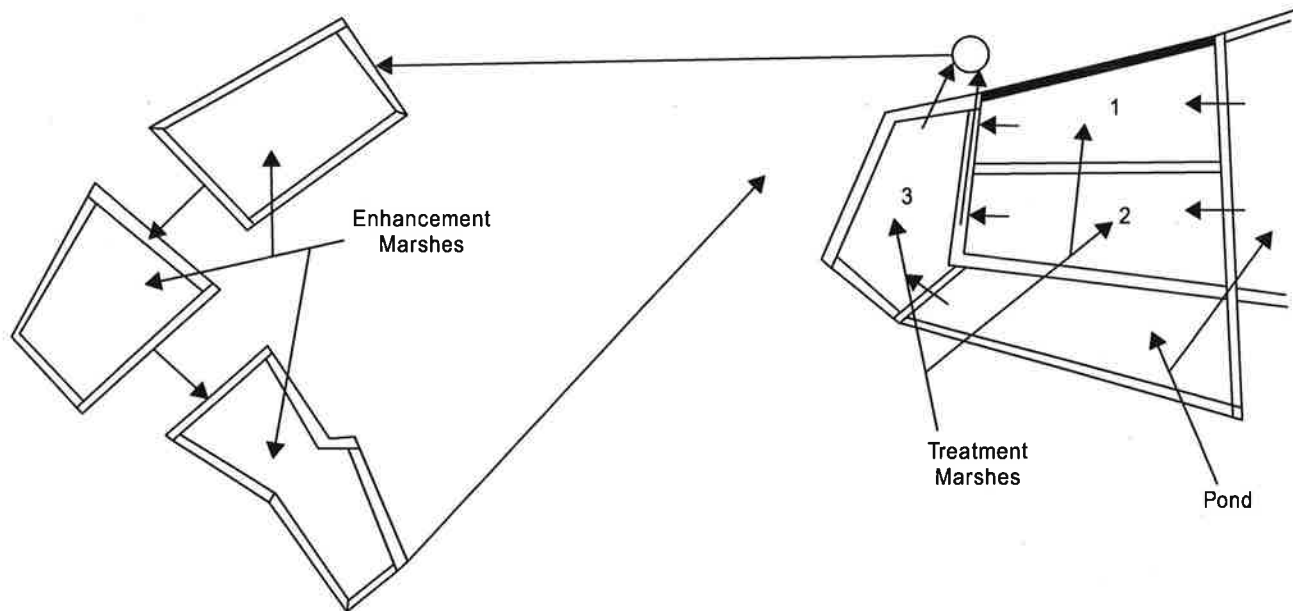


Figure 8-1. Schematic diagram of wetland system at Arcata, CA

ties, or the pumping and piping costs to reach the enhancement marshes. Land costs also are not included since the treatment wetlands were located on city-owned property.

8.1.1.2 Financial Arrangements

Construction costs for the Arcata system were funded by a state/federal construction grant program with a grant for 85% of the project costs. O&M costs for the system are paid with a surcharge on the consumer's water bills.

8.1.1.3 Construction and Start-up Procedures

Three of the final cells in the existing treatment pond were selected for the treatment wetlands. This allowed the use of city-owned land at no cost, a gravity flow connection from the ponds, and clay soils that eliminated the need for liners and minimized the earthwork requirements. The lagoon cells were drained and dried, local fill was placed to the desired grade, and the wetland bottoms were graded level. Shallow drainage channels were excavated to permit draining of the cell if desired. Construction of inlet and outlet structures completed the construction activities. Each cell has only one inlet and outlet structure. The wetland effluent was collected from the bottom of the wetland in each of these structures. The inlet structure has an adjustable weir so the flow to the three cells can be balanced. The outlet weir is not adjustable and was originally designed to maintain a 2-ft water depth in the cell. Prior to the 1997 site visit, timber sections had been bolted to the top perimeter of the outlet box. This raised the water level in the bed and converted this box to a four-sided overflow weir. This allowed wetland effluent to be decanted from the top of the wetland rather than off the bottom. The new 4-ft water depth was intended to suppress undesirable plant species that had started to spread in the wetland.

The treatment wetland cells were hand planted with hardstem bulrush with clumps of shoots and rhizome material planted on about 1-m centers. These plants were obtained from the pilot wetland channels. The wetland cells were flooded to a very shallow depth with tap water for about three months to encourage new plant development and growth. Wastewater was not applied at full depth until the new plants were 3- to 4-ft tall and construction of the rest of the system was complete (that is, effluent pump station and other features).

The enhancement marshes were constructed on available waterfront land but at some distance from the basic treatment system, so a pumping station and transmission piping were required. These enhancement wetlands were also sited on clay soils, so extensive soils and geotechnical investigations were not necessary. The grading for these wetlands was more complex than the treatment wetlands because berms did not previously exist, and it was desired to produce a wetland with different water depths and with several nesting islands in each cell. Each of these cells also contains a single inlet and a single outlet structure. The final effluent comes through a highly vegetated zone of emergent macrophytes with no open water. The final cell is followed by a pumping station to return effluent to the treatment plant for final disinfection and discharge.

The entire treatment system is operated and maintained by three operators who work five days per week and are on call on weekends. The only wetland-related O&M task is adjustment of the inlet weirs to ensure that flow is properly balanced and to visually observe the status of the treatment wetlands; this might require 20 minutes per day. With a total O&M effort of 87 hours per year at an assumed rate of \$30/hr for operator costs, the O&M costs for the treatment wetlands alone would be \$2,600 per year. The O&M costs for the pumping and the double chlorination would add significantly to that, but these are unique to the Arcata system and not generic to all wetland systems. Harvesting or other special vegetation-management activities are not practiced at this site.

8.1.1.4 Performance History

Performance data were collected for a two-year period during the Phase 1 pilot testing program. This program varied the flow rate and water depth in each of the two cells to compare BOD removal performance at different detention times and loading rates that would represent the potential range for full-scale application at Arcata. These data are summarized in Table 8-1. The BOD and TSS in the pond effluent varied considerably during this period, and not all of the cells were uniformly vegetated. *Seasonal variations in performance were observed, but Table 8-1 presents only the average effluent characteristics for each of the cells over the entire study period.* It is apparent from the data that the wetlands were able to produce excellent effluent quality over the full range of loadings and detention times used.

The long-term average performance of the Arcata system is summarized in Table 8-2. It is clear that both the treatment and enhancement marshes provide significant treatment for BOD and TSS. The long-term removals follow the pilot project results. Most of the nitrogen is removed during the final stage in the enhancement marshes. This is because of the long hydraulic detention time (HRT = 9 d), the availability of oxygen and nitrifying organisms in

Table 8-1. Summary of Results, Phase 1 Pilot Testing, Arcata, CA (cells 1-4 had received two different hydraulic loading rates for one year each-the higher loading occurred the first year)

Item	HRT (Actual)	HLR gal/ft ² -d	BOD ₅ mg/L	TSS mg/L	FECAL COLI CFU/100 ml
Influent		26	37	3183	
Effluent:					
Cell 1	2.1/10.7	5.89/1.22	11	6.8	317
Cell 2	1.5/17	5.89/0.5	14.1	4.3	272
Cell 3	2.7/29	4.66/0.5	13.3	4.7	419
Cell 4	1.5/15	5.39/0.5	12.7	5.6	549
Cell 5	3.7	2.94	14.0	4.3	493
Cell 6	5.2	2.4	10.7	4.0	345
Cell 7	5.2	4.4	13.3	7.3	785
Cell 8	5.2	2.4	15.3	7.2	713
Cell 9	6.6	1.71	11.9	9.4	318
Cell 10	3.8	1.71	12.6	4.9	367
Cell 11	7.6	1.47	9.4	5.7	288
Cell 12	5.5	1.47	9.0	4.3	421

Table 8-2. Long-Term Average Performance, Arcata WWTP

Location	BOD mg/L	TSS mg/L	TN mg/L
Raw Influent	174	214	40
Primary Effluent	102	70	40
Pond Effluent	53	58	40
Treatment Wetlands	28	21	30
Enhancement Marshes	3.3	3	3

the open water zones, and anoxic conditions for denitrification in the areas with emergent vegetation.

8.1.1.5 Lessons Learned

The treatment wetlands (7.5 acres), with nominal HRTs of three days, met weekly limits of 30 mg/L BOD and TSS 90% of the time. The enhancement wetlands (28 acres), with a nominal HRT of 11 days, met weekly limits of less than 5 mg/L BOD/TSS 90% of the time. Performance of both wetlands results primarily from proper operation and appropriate design that involves a combination of emergent vegetation and open water zones. TSS levels are higher in cell effluents where outlets are located in open water zones.

Wetland habitat values and opportunities for research and environmental education provided by the enhancement marshes were optimized to gain state approval for a near-shore discharge to Arcata Bay. Optimizing ancillary benefits appears also to have complemented treatment capabilities.

Nitrogen leaving the treatment wetlands in the ammonia form is nitrified in the open water zones in the enhancement marshes, where deeper open water zones with submerged stands of Sago pond weed (*Potamogeton pectinatus*) produce oxygen, and plant surfaces become the substrate for attached- growth nitrifying organisms. This plant also offers important habitat values since it is a major food source for many duck species. Long total detention times (~9 d) and alternating open and vegetated zones resulted in excellent nitrogen-removal performance.

Duckweed that grows on the open water surfaces is prevented from becoming a permanent duckweed mat by sufficient wind action. In vegetated areas, duckweed does mat, and it impedes reaeration.

Denitrification takes place in the fully vegetated anoxic zones in the enhancement marshes.

Most of the fecal coliforms in the effluent are from birds and other wildlife in the marshes and not from wastewater sources.

Pilot-scale marshes produced better treatment than the full-scale treatment wetlands, possibly due in part to the different configurations of the two systems and the possibility for short-circuiting in the larger full-scale cells. A 3:1

aspect ratio for the full-scale cells is acceptable as long as the influent is uniformly distributed over the full width of the cell and the effluent collected in a comparable manner.

Short-circuiting probably occurs in the treatment cells, but this could be corrected by replacing the single-point inlet and outlet structures with perforated pipe manifolds extending the full width of the cell.

8.1.2 West Jackson County, Mississippi

8.1.2.1 Background

The West Jackson County (WJC) wastewater treatment system is owned and operated by the Mississippi Gulf Coast Regional Wastewater Authority. It is one of several treatment systems serving communities within the Authority's boundaries. The system is located near Ocean Springs, MS, on the north side of I-10, about 20 miles east of Biloxi, Mississippi.

The original WJC system included a 75-acre, multiple-cell facultative lagoon for preliminary treatment followed by 415 acres of slow-rate (SR) land treatment fields (growing hay). The land treatment site was underdrained, and a portion of that recovered water was to be used to supplement dry-weather flow into marshes in the Mississippi Sandhill Crane National Wildlife Refuge. This system commenced operation in October 1987 with a design flow rate of 2.6 mgd and a 56 d HRT. Problems developed soon after start-up since the clay soils at the land treatment site proved not to be as permeable as originally expected. After extensive investigations and discussions, the design consultant agreed to design and construct a supplemental free water surface wetland to treat the excess flow.

Three parallel wetland units were constructed with a total area of 56 acres to treat a design flow of 1.6 mgd. The discharge from this new wetland was to Castapia Bayou, with NPDES permit limits for BOD at 10 mg/L, TSS at 30 mg/L, $\text{NH}_4\text{-N}$ at 2 mg/L, DO at 6 mg/L, pH at 6.0 to 8.5, and fecal coliforms at 2200/100 mL. Phase 1 of this new wetland was placed in operation in 1990 and Phase 2 in 1991. Figure 8-2 is a schematic diagram of the 56-acre wetland. Detailed costs are not available for the Phase 1 and 2 wetlands since they were funded privately by the design consultant as part of the agreement with the Wastewater Authority. Costs for Phase 3 (2.4 mgd) are available.

The Phase 1 wetland had two cells in series totaling 22 acres. The Phase 2 wetland (set 2) had three cells totaling 21.5 acres and another (set 3) which had two cells with a total area of 12.5 acres. Local soils were all clays, so a liner for these wetlands was not required. Bottoms of all wetland cells were constructed with an average slope of 0.19% in the flow direction. At the end of each cell, multiple weir boxes were used as outlet structures with adjustable weir plates, allowing a maximum water depth in the outlet zone of up to 2 ft. At the mean depth of 0.75 ft, the design hydraulic residence times in the three wetlands were 12.5 d in Phase 1, 10.1 d in Phase 2-2, and 10.7 d in

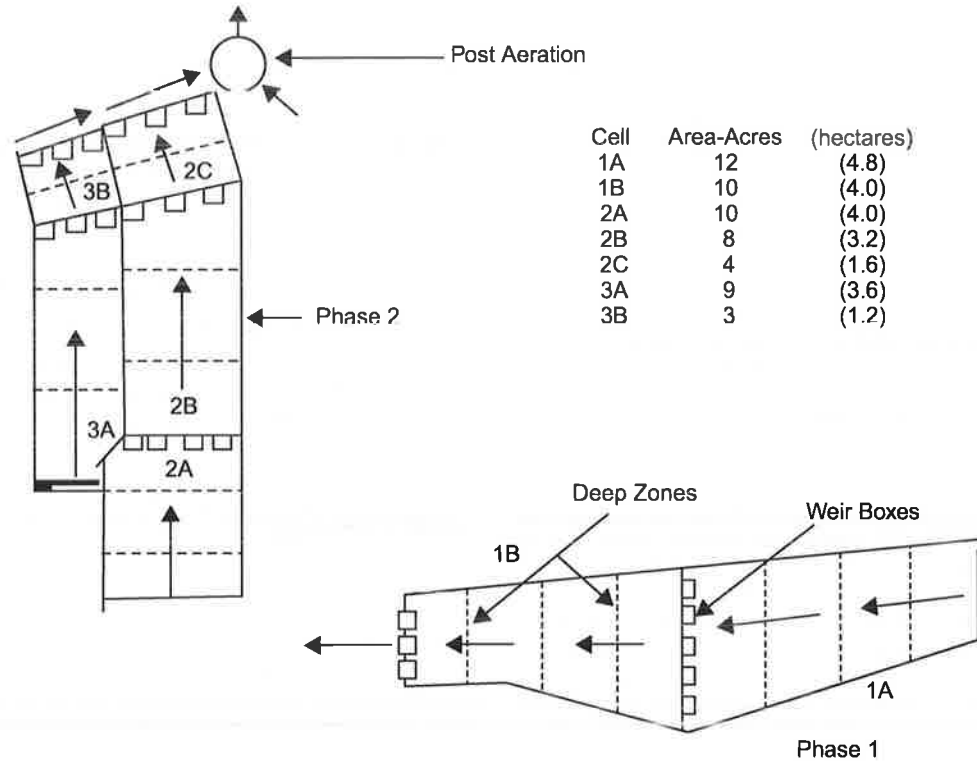


Figure 8-2. Schematic diagram of Phase 1 and 2 wetland systems at West Jackson County, MS

Phase 2-3. The inlets to all three sets of cells used a 12-inch perforated PVC pipe manifold. The elevation of the Phase 1 wetland was slightly higher than the lagoon, so it was necessary to pump lagoon effluent to this wetland. The Phase 2 wetlands were at a lower elevation, and gravity was used as the motive force.

A unique feature of this wetland system was the incorporation of "deep zones" in each wetland cell. These consisted of trenches excavated perpendicular to the flow direction, with the bottom of the trench excavated about 5 ft below the general wetland bottom surface. This provided a water depth of about 6 ft in these "deep zones," which was sufficient to prevent colonization by the emergent wetland plants. These trenches are about 20 ft wide at the bottom and about 40 ft wide at the top. The purpose of these "deep zones" was to redistribute the flow across the width of the cell to minimize short-circuiting and to provide an open water surface for atmospheric reaeration to supply the oxygen necessary for ammonia removal. The potential open water provided by these zones was only about 10% of the surface area in each wetland cell. The water surface in these zones also quickly became colonized by duckweed (*Lemna* spp.).

In larger open water bodies, duckweed is very susceptible to wind action; as a result, the water surface can re-

main available for atmospheric reaeration. At this location, with the relatively narrow "deep zones" and the protection provided by the adjacent emergent vegetation in the shallow portions of the marsh, wind was not sufficient to move the duckweed mat, and oxygen transfer from the atmosphere did not develop.

Because there was insufficient oxygen in the system to continuously support nitrification reactions, there were seasonal violations (particularly in late summer and early fall) of the ammonia limits commencing in 1992. Corrective action for this problem considered an external vertical-flow filter bed for nitrification and submerged tubing aeration in the "deep zones" to provide the necessary oxygen. The latter was selected as the lower-cost alternative and was installed in 1993. Problems again developed because nutria (an animal similar to a muskrat), which occupy the wetland in large numbers, were attracted to the air bubbles and destroyed the aeration tubing by gnawing on it. In subsequent discussions with the State of Mississippi, it was decided that the ammonia limit would not be enforced until the Castapia Bayou began to exhibit oxygen stress, so the aeration tubing was not replaced.

The population is increasing rapidly in the communities served by this system, and by 1996 the average flow into these wetland units had reached 2.2 mgd. The Wastewa-

ter Authority then authorized an upgrade and expansion of the facility for a design flow of 5 mgd (1 mgd to land treatment, 4 mgd to wetlands). The design was completed in 1996 and construction began in August 1997. The expansion included modifications to the lagoon (providing aeration and baffles), 50 acres of additional wetland area, a plastic-media trickling filter bed for nitrification, UV disinfection, and additional post-treatment aeration to ensure adequate DO in the final effluent. The expanded wetland system is shown in Figure 8-3. The trickling filter component has been designed but will not be constructed until the State of Mississippi decides it will be necessary. Recent data, shown in Figure 8-3, indicate that the open water zones appear to be functioning well. A UV disinfection system was added to the system because the NPDES permit limits for fecal coliforms have been modified to 200/100 mL in the summer and 2000/100 mL in the winter.

Additional features of the existing Phase 1 and Phase 2 wetlands include post-treatment aeration to satisfy the NPDES discharge limit for dissolved oxygen (6 mg/L). Multiple outlet structures with adjustable weirs are used for cell-to-cell transfer and for final discharges from the wetlands. A miniature "deep zone" was excavated around each of these structures to prevent the growth of emergent vegetation in the immediate vicinity, as done for a FWS system at Fort Deposit, AL. Published design mod-

els were not used in this case, and effluent quality (Figure 8-3) is excellent.

8.1.2.2 Financial Arrangements

The initial lagoon/land treatment system was funded under a federal/state construction grant program in existence at the time. The Phase 1 and 2 wetlands were funded directly by the design consultant. The Phase 3 expansion was funded through a revolving loan fund as administered by the State of Mississippi. Total costs for the entire Phase 3 project are estimated to be \$2,758,000 (1997\$). This includes lagoon modifications, UV disinfection, the nitrification trickling filter, and post-aeration. The costs for just the 50 acres of wetland expansion are estimated to be about \$700,000, or \$14,000 per acre, or \$250 per 1000 gallons of design flow capacity. Land costs for this project are not included in this estimate since the land already belonged to the Wastewater Authority. The O&M costs are funded by a surcharge on each consumer's water bill within the Authority's service area.

8.1.2.3 Construction and Start-up Procedures

The site for the original lagoon and land treatment site was selected for its proximity to the Mississippi Sandhill Crane National Wildlife Refuge, where the treated effluent could be utilized in refuge marshes. The sites for the Phase

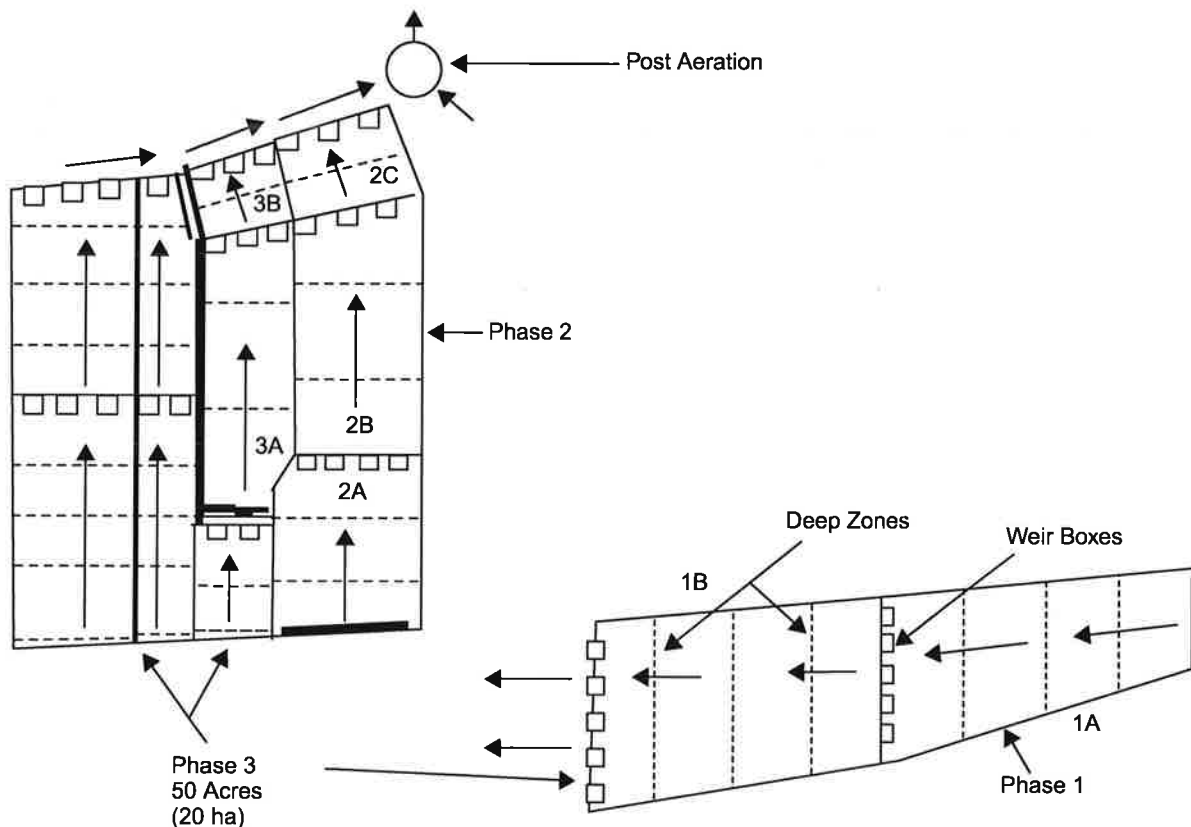


Figure 8-3. Schematic diagram of Phase 3 wetland expansion at West Jackson County, MS

1 and 2 wetlands were selected to take advantage of available land already owned by the Wastewater Authority and for proximity to Castapia Bayou for the system discharge point. As shown in Figure 8-3, the Phase 3 wetlands were then located to utilize the remaining land available on this site.

The site investigation for the wetlands included a geotechnical investigation which indicated that ground water impacts or intrusion would be minimized by underlying clay subsoil. Borings and test pits verified the presence of these clay soils throughout the proposed wetland area. Wetland sites originally were covered with scrub pine and related ground cover, so clearing and grubbing of the site was the first construction task. This was followed by excavation to grade with typical highway construction equipment and construction of both the external and internal berms with spoil material from the excavations. A liner was not necessary due to the low permeability of clay soils, but geotextiles were used adjacent to the inlet and outlet structures to prevent erosion. The multiple concrete outlet and transfer structures were cast in place.

The bulrush (*Scirpus* spp.) and cattails (*Typha* spp.) selected as the vegetation for this wetland system were obtained locally by cleaning drainage ditches within the Authority's jurisdictional area. The plants were brought to the site and separated, and shoots were cut to about 1 ft in length and planted by hand in individually augured holes. The plants were placed on about 1-m centers. At that density, it would require about 227,000 plants to cover the original 56-acre wetland site. Observations at the time showed that two laborers could prepare and plant about 1,200 plants per day. At that rate it would require about 54 man-hours per acre to vegetate a wetland bed using this technique.

As soon as a zone was planted, it was flooded with a very shallow depth of stream water to encourage plant growth. Lagoon effluent at the design depth was not applied for at least 30 days after planting was completed. A pattern was adopted for Phase 1, on which alternating bands of bulrush and cattails were planted. This was abandoned for Phase 2, so whichever species was available on a given day was planted; as a result, cattails were the dominant species in Phase 2.

8.1.2.4 Performance History

At the original 1.6-mgd wetland design flow rate, the flow was split between the three wetland units: 0.6 mgd to Phase 1, 0.65 mgd to Phase 2-2, and 0.35 mgd to Phase 2-3. During the period 1992 to 1995, the average effluent characteristics from the facultative lagoon were BOD 31 mg/L, TSS 33 mg/L, TKN 12.9 mg/L, and NH₄-N 4.4 mg/L. During this same period, the combined final effluent from the wetland units met all NPDES limits on an annual average basis: BOD 7.5 mg/L, TSS 4.6 mg/L, and NH₄-N 1.85 mg/L. On a monthly basis, there were excursions; the BOD exceeded permit limits eight times (18%) and ammonia exceeded limits 11 times (25%). The BOD violations were randomly dis-

tributed throughout the period and generally reflected higher-than-normal loading. A more specific pattern was shown by the ammonia, with the violations occurring in late summer and early fall. By 1996 the flow rate to the wetlands had increased to 2.35 mgd (47% higher than the original 1.6 mgd design), and the excursions for both BOD and NH₄-N were more frequent. Table 8-3 summarizes performance data for the period January 1996 through July 1997. It would appear from the data in this table that BOD removal is slightly better in the warmer months, indicating some dependence.

8.1.2.5 Lessons Learned

The inlet zone was submerged with a significant depth of water, so the overland flow mode with very shallow sheet flow did not develop. Ammonia removal provided by the shallow sheet flow of water and the continuous availability of oxygen intended for the system did not take place, even with the weirs at their lowest setting.

"Deep zones" in each cell were intended to provide additional oxygen to support nitrification reactions, but this benefit was not realized when duckweed mats formed over the surface of the deep zones. A single large "deep water" zone in each cell, instead of multiple narrow trenches, should have allowed sufficient duckweed movement to sustain atmospheric reaeration.

The Phase 3 design provides both a perforated manifold and an open ditch "deep zone" in the inlet area of the cells to promote proper lateral distribution of the influent and increased volume to capture incoming TSS.

Bulrush plants had been almost completely removed by muskrats and nutria using these plants for food and nesting material, but damage to cattails was minor. Damaged

Table 8-3. Wetland Water Quality, West Jackson Co., MS

Date	BOD ₅ , mg/L		TSS, mg/L		NH ₄ -N mg/L	
	In	Out	In	Out	In	Out
1996						
Jan	36	10	28	12	7	4
Feb	32	13	21	10	12	4
Mar	36	12	24	14	9	6
Apr	30	14	18	6	9	6
May	32	8	32	5	10	4
Jun	38	6	38	3	18	4
Jul	36	3	42	5	6	3
Aug	37	9	60	12	12	2
Sep	32	8	40	13	2	2
Oct	34	8	90	7	2	1
Nov	34	8	41	5	2	1
Dec	20	10	17	3	1	1
1997						
Jan	33	13	18	5	1	1
Feb	23	9	17	6	2	2
Mar	43	10	24	5	16	8
Apr	41	9	23	4	9	6
May	28	4	24	2	9	7
Jun	47	6	23	2	1	2
Jul	42	4	43	3	3	2

sections in Phase 1 were planned to be temporarily drained and replanted with cattails. In the new Phase 3 addition, cattails were proposed as the only plant in the bottoms, and a variety of attractive flowering wetland species were planned for the inside perimeter of the new cells.

The system supports large numbers of birds and other wildlife, even though special measures to enhance habitat values were not taken in Phases 2 and 3.

Birds and other wildlife in the wetlands appear to have a significant impact on effluent fecal coliforms from the system, with the final wetland effluent often higher than lagoon effluent entering the wetland.

8.1.3 Gustine, California

8.1.3.1 Background

Gustine is an agricultural community located in the Central Valley of California on the east side of I-5 and about 60 miles south of Stockton. There are several milk-processing industries in the community that impose high organic loadings on the municipal wastewater treatment system. The original treatment system consisted of an oxidation pond with 14 cells operated in series (HRT \approx 56 d, average pond depth \approx 4 ft), with final discharge without disinfection to a small stream. Approximately one-third of the 1 mgd design flow originates from domestic and commercial sources; the remaining two-thirds come from dairy product industries. This combination produces a high-strength wastewater with an average BOD of about 1200 mg/L and TSS of 450 mg/L, and these characteristics resulted in frequent violations of the 30 BOD/30 TSS NPDES discharge limits for the original lagoon system.

In 1981, a Facility Plan for the city was funded under the Clean Water Act. This plan considered a number of alternatives for upgrading the existing treatment system. The most cost-effective alternative was assumed to be a facultative lagoon followed by a constructed free water surface (FWS) wetland for final polishing to consistently meet the NPDES discharge limits. Since design criteria for FWS wetlands were not well established in 1981, a pilot test to develop final design criteria was recommended.

A pilot study was approved and was conducted from December 1982 to October 1983. The pilot system modified an existing ditch that already contained a stand of cattails. The pilot cell was 39 ft wide and 900 ft long. Partially treated water was taken from various intermediate pond cells. The influent to the pilot wetland averaged 180 mg/L BOD and 118 mg/L TSS. At the operational water depth of 6 in, the HRT in the wetland averaged 2.5 d. The BOD and TSS in the wetland effluent stabilized at 30 mg/L after the start-up period. Just prior to the pilot testing, one of the dairy industries closed and was not expected to reopen. This resulted in lower-strength wastewaters than had been previously experienced, and these were expected to prevail in the future. The pilot results were used as the basis for the design and sizing of the full-scale wetland component. Construction of the system commenced in March 1986 and was completed in October 1987.

Three of the 14 existing lagoon cells (plus some additional adjacent land) were selected as the site for the new wetland component. This area was converted to 24 wetland cells operating in parallel. Each cell had a net area of about 1 acre and was 38 ft wide and 1107 ft long (L:W = 29:1), similar to the size and the configuration of the pilot wetland unit. Internal berms constructed to separate the wetland cells were 10 ft wide and 2 ft deep. An exterior levee 6.5 ft high was constructed around the entire wetland area to provide protection from the hundred-year flood, as required by the State of California. Influent flow from the lagoon passes through a distribution box where V-notch weirs divide the flow into six equal parts. Each part of the flow is then piped to a group of four cells. Gated aluminum pipe is used to distribute flow across the width of each cell. In order to provide flexibility for high-strength flows, a simple step-feed arrangement was designed. Pipe manifolds were located at the inlet to each cell and at the one-third point along the flow path. Each manifold was valved so the operator could vary the amount of flow applied to each and thereby avoid an overloaded inlet zone. An adjustable outlet weir at the end of each cell allows a water depth ranging from 4 to 18 in. These weirs discharge to a common sewer, and the effluent is then pumped to the chlorine disinfection/dechlorination system. At the design flow of 1 mgd, the design projected an average HRT at higher loading of about seven days, which could be varied from 4 d in the summer to 11 d in the winter, depending on the number of cells in operation and on the water depth used. This operational flexibility allowed for each cell to be taken out of service each summer for vegetation management or other O&M, if required. The system is schematically depicted in Figure 8-4.

At the time this system was designed, the capability to effectively remove algae in FWS wetland systems was not clearly established. This issue was a concern since very high concentrations of algae were known to develop during the summer months in some of the lagoon cells at Gustine. In order to provide the operator some control over this situation, the new design incorporated separate outlet structures in each of the last seven cells of the remaining 11-cell (in series) lagoon system. In this way, the operator could visually observe which cell(s) had the least amount of algae present and select those for discharge to the wetland.

Soon after the 1987 system start-up, the milk-processing industry in Gustine that had been closed for several years was reopened and full-scale operations commenced. This imposed a higher than expected organic load on the treatment system; as a result, the lagoon/wetland system could not consistently meet the 30/30 (BOD/TSS) NPDES discharge limits, especially during the winter months. Following consent decree discussions with the U.S. EPA, the City of Gustine evaluated the performance of the system and recommended action that would bring the system into compliance. The major system modification resulting from this study was the addition of floating aerators to most of the lagoon cells in order to reduce the organic loading.

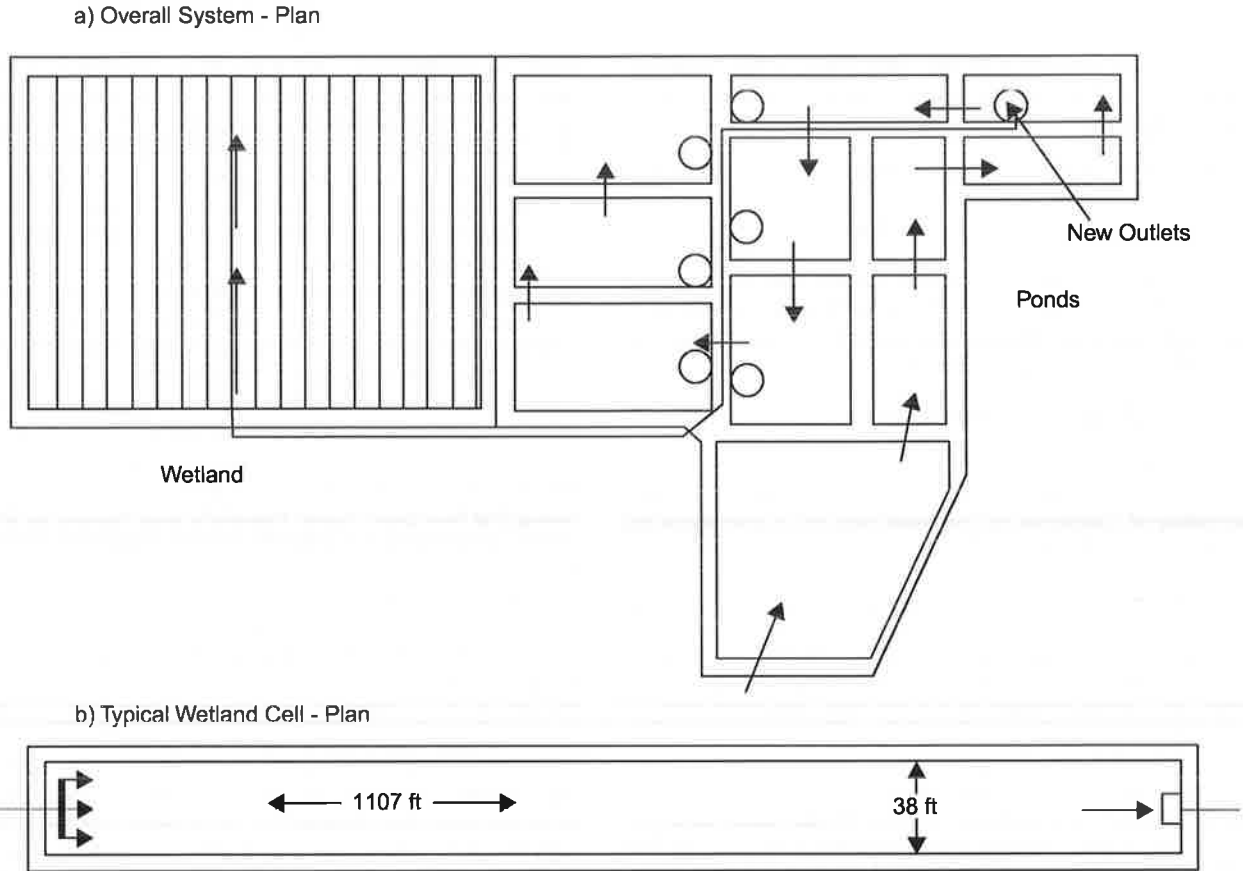


Figure 8-4. Schematic diagrams of the wetland system at Gustine, CA

The shallow 4-ft depth of the lagoon cells is not desirable for efficient aeration but was too expensive to modify. Aspirator aeration equipment was selected for this project because of the shallow water depth. This equipment was installed in 1992, and the lagoon has performed acceptably since.

8.1.3.2 Financial Arrangements

Federal and state funding for the facility plan, the pilot study, and the design and construction of the wetland system was provided under the Clean Water Act Construction Grant Program administered in the early 1980s. The total construction cost for this wetland system was \$882,000 (August 1985\$). This includes the cost of the multiple-pond outlet structures and related piping and the 6.5 ft levee around the perimeter of the wetland area. On an area basis (24 acres of treatment area), the cost would be \$36,750 per acre. On a design flow basis (1 mgd system), the cost would be \$882 per 1000 gpd of treatment capacity. Land costs are not included since the area was already owned by the city. The gross area utilized was about 36 acres for the wetlands, levees, and disinfection facilities.

For this facility, O&M costs are funded by a surcharge on the consumer's water bill. The City of Gustine budgeted \$433,275 in 1996 for operation and maintenance of the wastewater treatment and sewerage systems in the community. Based on a 1-mgd design flow, the unit costs would be \$1.19 per 1000 gallons treated. The O&M costs for just the wetland component are minimal and might represent less than 10% of the total (e.g., \$0.12/1000 gpd).

8.1.3.3 Construction and Start-up Procedures

There were no soils or geotechnical or ground water investigations at this site prior to or during construction. The local soils were clays and the existing lagoons are unlined, and it could therefore be assumed that the wetland cells would not require lining. The site lay within the flood plain of a small local stream, and the State of California did require a 6.5-ft high levee to protect the new wetland system from the hundred-year flood.

Construction commenced with the draining and drying of the three existing lagoon cells and clearing and grubbing of the adjacent land required to complete the system.

The entire wetland area was excavated to grade, with a flat bottom, and then the interior berms were placed as fill. Construction of the inlet and outlet structures and the related piping completed the physical aspects of the wetland system.

Cattails (*Typha latifolia*) and tristar bulrush (*Scirpus californicus*) were selected for use on this wetland project. The specifications required that 18 of the cells would be planted with cattail rhizomes on 3-ft centers, and the remaining six cells would be planted with bulrush rhizomes on 1.5-ft centers. During the first planting attempt in September 1986, rhizomes of both plant species were obtained at local natural stands and spread on the wetland surfaces and disked into the soil. Water was not available for irrigation and very few plants emerged the following spring. The second planting attempt occurred in June 1987 and consisted of mechanical planting of cattail seedlings obtained at a nursery. The bed was then flooded with high-BOD pond effluent. Almost all of the plants died in a short time. It is believed this was due to heat stress (the air temperatures were 100°F) and the high oxygen demand from the poorly treated water used to irrigate. The contractor also seeded the wetland area by broadcasting mixed bulrush seed (hardstem and tristar). Some live cattail plants were also transplanted to the wetland beds from local drainage ditches. These more mature plants survived, whereas the small seedlings did not. By the fall of 1987, a few of the cells were almost completely covered with bulrush plants, but the majority contained random stands of bulrush and isolated patches of cattails.

As a result of these planting problems, the system started up in 1987 with insufficient plant cover to provide the necessary substrate for treatment and an organic loading that was more than double the design load. In the spring of 1988, about half of the cells had moderately dense growth over about 75% of the cell area. The other half of the system contained only random patches of bulrush and cattails. This situation improved slowly during subsequent years; at the time of the 1989–1990 wetland evaluation, the wetland cells were still not completely covered with vegetation.

The hardstem and tristar bulrush gradually spread and became the dominant species on the system. The wetland could be considered to be completely vegetated since early 1993. However, during the 1997 site visit for this report, patches of sparse vegetation and some open water areas were still observed on some cells. As the density of the vegetation increased, it began to create hydraulic problems for operation of the system. Flow through these FWS wetlands is thought to be governed by Manning's equation. The frictional resistance to flow through a wetland bed is significantly higher than in a normal grassed drainage channel since the vegetation (and litter) exists throughout the full depth of the water column. This resistance obviously increases and the length of the flow path increases. A system with a high

aspect ratio (29:1 at Gustine) has the potential to develop a high enough resistance to force the water level at the inlet to increase very significantly in order to provide the necessary hydraulic gradient. This occurred at Gustine, and the water level at the inlets overtopped the shallow berms. The operator had two options to solve this problem: increase the height of the berms or reduce the resistance to flow. He chose the latter course and got permission to burn the vegetation in late fall after senescence. This immediately solved the hydraulic problem, and burning has become an annual occurrence at Gustine.

There were no special start-up procedures used at this system, and pond effluents at the full rate were applied to all of the wetland cells regardless of vegetation coverage in the fall of 1987. However, until corrective action was taken in 1992 to reduce the organic loading in the ponds, the system frequently did not meet the NPDES discharge limits.

8.1.3.4 Performance History

As described in the previous section, this system did not consistently meet the NPDES limits at start-up and for several years thereafter. The problem was due to a higher than expected organic load (particularly in the winter months) and the lack of significant vegetation coverage on most of the wetland cells. The vegetation and litter in these FWS systems serve as the means for enhanced flocculation and sedimentation that actually perform the treatment. The importance of this vegetation and litter can be seen by comparing the data in Table 8-4. These are performance results obtained during the 1989–1990 winter in the special evaluation study, when several cells in the Gustine wetlands were isolated and a careful performance evaluation was conducted over a one-year period. One cell (#6D in their set) was almost completely vegetated with bulrush; the other cell (#2A in their set) listed in Table 8-4 was sparsely vegetated with some bulrush and cattails. The influent BOD was slightly different for the two cells because different source ponds were in use, but during the period of concern the influent values were in the same range. The HRT during this period was about 10 d for both cells.

This FWS wetland system has had problems in meeting its NPDES discharge limits since start-up. During the period 1987 to 1992, the problem was believed to be an organic overload on both the lagoon pretreatment and on the wetland component in this system as evidenced by the data in Table 8-4. The system design expected a BOD concentration of 150 mg/L entering the wetland, but the actual average wetland influent BOD during this initial period was close to 300 mg/L, with weekly excursions up to 630 mg/L during the winter months. This problem was compounded by the immature vegetative growth in the wetland cells that significantly reduced the flocculation/sedimentation treatment potential. The organic loading problem was corrected by the addition of aeration capacity to the lagoon component, and the plant density has gradually increased on the wetland cells.

Table 8-4. Performance Results in Mature Vegetated vs Immature Vegetated FWS Cells, Gustine, CA

Month 1989-90	Temp °F*	Full Vegetation				Partial Vegetation			
		BOD ₅ , mg/L		TSS, mg/L		BOD ₅ , mg/L		TSS, mg/L	
		In	Out	In	Out	In	Out	In	Out
Nov	50	54	8	72	13	49	20	80	24
Dec	43	154	17	103	6	150	66	104	42
Jan	44	525	35	116	24	515	153	113	71
Feb	45	483	29	79	19	478	123	86	49
Mar	56	215	16	100	17	185	21	94	20
Avg	-	286	21	94	16	275	77	95	41

* Average water temperature in the marsh cells

Table 8-5 presents current wetland effluent BOD and TSS values for 1996–1997. Ammonia (NH₃) and Kjeldahl nitrogen (TKN) values also were measured during the first half of 1996 and are shown in Table 8-5. Wetland influent characteristics were not measured during this period, but the new aerators in the lagoon cells were operating continuously, so it can be assumed that the organic loading on the wetland probably does not exceed the original design expectations. During 1996 the average daily flow into the treatment system was 1.02 mgd, which is essentially equal to the design capacity, so the system is not overloaded hydraulically. It is clear from these data that this wetland system is still having difficulty meeting the NPDES discharge limits. The effluent BOD exceeded 30 mg/L twice during 1996 and once during the first half of 1997; the effluent TSS met the 30 mg/L limit three times during 1996 (25% of the time) and three times during the first half of 1997 (50% of the time).

8.1.3.5 Lessons Learned

Poor performance evident in the 1996–1997 data may not have been caused by an organic overload, since the effluent BOD had been significantly below the discharge limit most of the time, and the few BOD excursions were relatively small and occurred mostly during the warm months. Birds and other wildlife may be a contributing factor. Detritus and similar natural organic materials may also be a source for the excess TSS.

Plant litter allowed to accumulate in the cells may improve water quality. With the litter burned each year, solids entrapment must depend on living plants. Also, the tristar bulrush that dominates many of the wetland cells has narrow stalks and no leaves, so the plants' surface area beneath the water surface is minimal, further reducing entrapment of solids. However, plant litter in the channels caused hydraulic failure when resistance to flow increased and the cells overflowed their banks at the entry zone, owing to the excessive L:W ratio.

The hydraulic problem was corrected in 1995 when three interior berms in each set of four cells were removed and some of the surplus material was used to increase the height of the remaining berms. This action reduced the system to six larger cells, changed the aspect ratio from 26:1 to 5.5:1, and increased water depth near the entry

zone. Removing the three interior berms also opened up an additional 30,000 ft² in each of the remaining cells to serve as part of the wetland.

The initial selection of long, narrow wetland channels was consistent with wetland design experience available in 1983–1984, but experience has since shown that proper treatment can be achieved in FWS wetlands with aspect ratios as low as 2:1 to 3:1 as long as the system is properly constructed and the inlet and outlet structures allow for uniform flow through the system.

Separate outlet structures at seven of the 11 lagoon cells allow the operator to select the lagoon cell(s) with the least algae for discharge to the wetland. This technique has been very effective at algae removal as long as sufficient plants and litter are present in the wetland, and as long as velocity of flow in large open water zones is sufficient to prevent redevelopment and discharge of algae to the FWS system.

Toxicity discharge limits imposed by the State of California for un-ionized ammonia could not be met by the existing pond-wetland system in the present mode of operation. The existing point discharge is planned to be abandoned and the effluent from the wetland component to be used for irrigation in a slow-rate land-treatment system.

8.1.4 Ouray, Colorado

8.1.4.1 Background

Ouray is located in southwestern Colorado, about 60 miles north of Durango, on State Route 50. Its population is about 2,500 in summer and about 900 in winter. The town is at an elevation of 7,580 ft in a mountain valley and experiences severe winter conditions.

The free water surface (FWS) wetland at Ouray receives influent from a two-cell aerated lagoon and provides secondary treatment prior to chlorine disinfection/dechlorination and final discharge to the Uncompahgre River. The NPDES monthly average discharge limits are BOD₅ 30 mg/L, TSS 30 mg/L, and fecal coliforms 6000 CFU/100 mL. The wetland was designed for an expected winter water temperature of 3°C and a summer water temperature of 20°C, with a 25% safety factor on sizing for BOD removal, based on existing design equations.

Table 8-5. Wetland Effluent Characteristics, Gustine, CA

Month	Temp. °F	BOD ₅ , mg/L	TSS, mg/L	NH ₄ -N mg/L	TKN, mg/L
1996					
JAN	48	21	20	13	15
FEB	54	20	22	16	18
MAR	55	16	24	11	16
APR	61	30	45	4	7
MAY	64	29	57	3	9
JUN	72	18	41	2	7
JUL	75	22	36	7	15
AUG	70	47	71	-	-
SEP	63	32	39	-	-
OCT	59	26	43	-	-
NOV	52	28	42	-	-
DEC	48	24	50	-	-
1997					
JAN	48	25	26	-	-
FEB	50	22	27	-	-
MAR	54	27	38	-	-
APR	61	24	34	-	-
MAY	66	22	26	-	-
JUN	70	31	34	-	-

The design flow for the 2.2-acre wetland system is 0.250 mgd in winter and 0.363 mgd in summer. As shown in Figure 8-5, the wetland includes two parallel trains with three cells each. The two trains operate in parallel, and one can be taken out of service during the summer months for maintenance if required. The curved configuration of these wetland cells was selected in part because of the confined site and in part for aesthetic reasons. The water depth in the cells is adjustable via the outlet from a minimum of 8 in to a maximum of 18 in. This water level is increased to the maximum depth prior to the onset of winter to provide the maximum possible detention time during the low temperature periods and to provide additional depth for ice formation on the water surface during the winter months.

A perforated manifold is used for both inlet and final outlet structures for the two sets of cells. Internal transfer from cell to cell is accomplished with two parallel pipes through each internal berm. The wetland cells are lined with 30-mil HDPE membrane liners to prevent seepage since the local soils are sandy clay loams. The detention time in the system depends on water depth and on the presence of winter ice. At minimum water depth the HRT is 2.2 d; at maximum water depth without ice, the HRT is 3.8 d. Locally obtained cattails (*Typha* spp.) and bulrush (*Scirpus* spp.) were planted in the wetland cells. The vegetation is continuous, and there are no intended open water zones.

The wetland was designed in 1992, constructed during the spring and summer of 1993, planted in October 1993, and placed in partial operation in November 1993. It has been in continuous operation since that time.

The construction costs for the entire system, including aerated lagoons, chlorine disinfection/dechlorination equipment, and miscellaneous features was \$816,530 (1993\$). Construction costs for just the treatment wetlands is esti-

ated to be about \$108,500 or \$49,300 per acre, or \$300 per 1000 gpd of design capacity.

8.1.4.2 Financial Arrangements

The construction costs for the Ouray system were funded by a state revolving-loan fund as administered by the State of Colorado in 1993. O&M costs for the system are funded with a surcharge on the consumer's water bills. The total monthly O&M cost for the entire system at Ouray is \$2,625; most of this is related to power costs, sludge removal from the aerated lagoon, and laboratory testing for NPDES monitoring. The average O&M costs for the wetland component is estimated to be about \$200 per month for minor maintenance tasks.

8.1.4.3 Construction and Start-up Procedures

A geotechnical investigation was undertaken at the site for the new wetlands to determine underlying soil properties and ground water conditions. Soil borings to several feet below the final wetland grade revealed the presence of sandy clay loams with sand and gravel inclusions, with an unconfined ground water aquifer at greater depth. These soils were typical of the local flood plain and were considered too permeable, so a membrane liner was selected for the wetland.

Clearing and grubbing was the first construction activity at the new wetland site. This was followed by grading, berm construction, and liner placement. Prior to liner placement, the subgrade was leveled and compacted to 90% of Proctor density to preserve the intended grade during subsequent construction activities. After the liner was placed, 1.5 ft of local sandy clay loam was placed in the wetland bottom to serve as the rooting medium for the wetland vegetation. The curved configuration of the wetland cells increased construction costs somewhat, but the site was

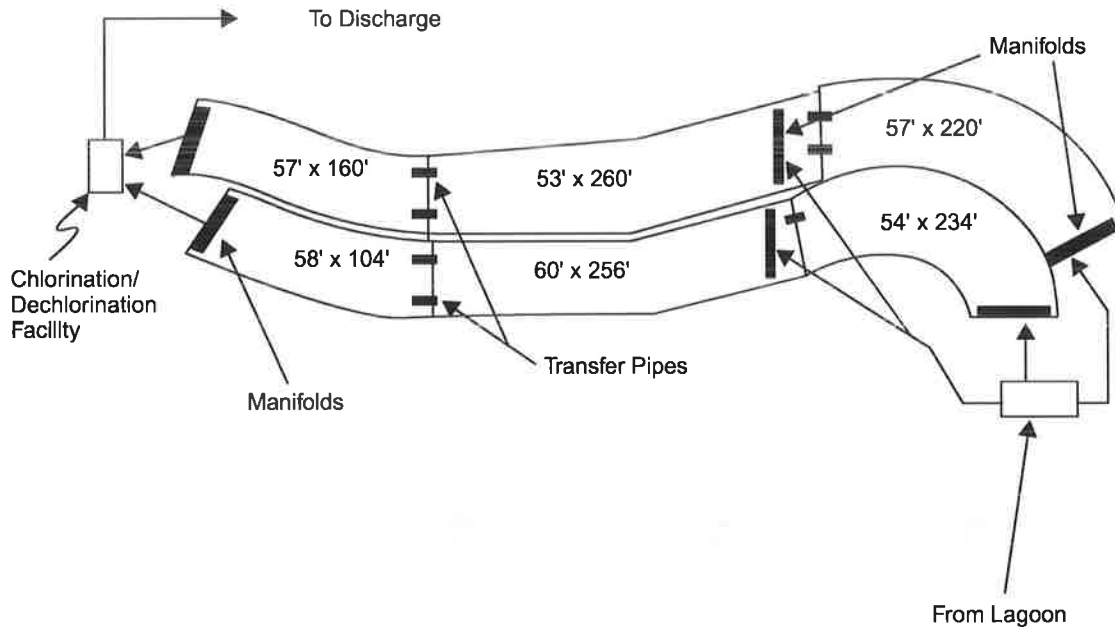


Figure 8-5. Schematic diagram of the wetland system at Ouray, CO

too confined to permit construction of a typical rectangular system with straight sides.

Treatment wetland cells were hand planted by correctional facility inmates with locally obtained bulrush and cattail plants. The vegetation was planted on about 18-in centers; at this density about 43,000 plants were required. The bed was flooded with about 8-in of water and maintained in that condition until sufficient new plant growth was observed. Some wastewater was applied during the remainder of the 1993 winter, but full-scale operation did not commence until the spring of 1994.

This system experiences subfreezing air temperatures for extended periods each winter. An ice cover at least 6-in thick persists for at least six months.

The inlet and outlet devices for each set of cells are 8-in, perforated, Schedule 80 PVC pipe. These pipes were laid in a 2-ft-wide, 18-in-deep trench extending the full width of the cell. The trench bottom and sides are protected with 2- to 4-in riprap. One end of each manifold has a 90° elbow and a capped riser extending above the water surface to serve as a cleanout if required. The effluent manifolds connect to a concrete outlet structure that contains adjustable outlet riser pipes for controlling the water level in the cells.

There are no special O&M requirements for these wetland units, including harvesting or other plant management procedures. Raising and lowering the wetland water levels on a seasonal basis and sampling for NPDES compliance are about the only O&M tasks required. There have been no problems with muskrats or other animals damag-

ing the plants as has occurred at several other wetland systems. The wetland tasks listed in the O&M manual include weekly cleaning of effluent debris screens, weekly checking of berms for erosion or muskrat damage, cleaning influent and effluent manifolds as required, and occasional muskrat control. Mosquitoes have not been a problem at this site.

8.1.4.4 Performance History

It is typical for most small systems, including the Ouray system, to monitor only for NPDES limits, and for that reason to sample only the untreated (raw) wastewater and the final effluent. As a result, the actual influent to the wetland component is not known. Data from the Ouray system for the 1995–1996 period is shown in Table 8-6.

Based on limited data, the aerated lagoon at Ouray is estimated to remove about 54% of influent BOD₅ and 65% of influent TSS. On that basis, with the average wetland influent in 1995 at 58 mg/L BOD₅ and 63 mg/L TSS, the wetland achieved an average removal of 83% BOD₅ and 90% TSS. In 1996, the average wetland removal percentages were 88% for BOD₅ and 91% for TSS. Wetland average effluent fecal coliform concentrations during 1995 and 1996 were 570 CFU/100 mL and 1300 CFU/100 mL, respectively. All of the monthly values were well below the NPDES limit of 6000 CFU/100 mL, so it was not necessary to operate the disinfection/dechlorination equipment installed at the site.

8.1.4.5 Lessons Learned

- The Ouray system incorporated many improvements learned from earlier FWS systems, including perforated

Table 8-6. BOD & TSS Removal for Ouray, CO

Date	BOD In, mg/L*	BOD Out, mg/L**	TSS In, mg/L*	TSS Out, mg/L**
1995				
Jan	84	5	124	11
Feb	78	8	122	8
Mar	84	7	216	10
Apr	132	9	182	5
May	66	8	152	11
Jun	174	15	196	4
Jul	180	14	170	5
Aug	216	10	316	5
Sep	204	18	296	4
Oct	132	16	144	6
Nov	96	6	146	5
Dec	78	3	98	4
Average	127	10	180	6
1996				
Jan	90	4	176	4
Feb	92	6	154	6
Mar	95	2	184	2
Apr	60	5	178	2
May	78	13	68	11
Jun	96	11	109	6
Jul	162	7	334	9
Aug	168	11	226	5
Sep	120	5	102	4
Oct	126	8	127	5
Nov	108	3	121	3
Dec	78	2	160	4
Average	106	6	162	5

*Untreated wastewater
 **Final system (wetland) effluent

manifolds extending the full width of the wetland cells for inlets and outlets, cleanouts on the ends of these manifolds, and a simple adjustable outlet structure for control of the water level in the wetland cells.

- The adjustable outlet structure for water-level control was essential for the water level to be raised during the winter months to accommodate expected ice formation.
- Large-sized riprap (4- to 6-in size) as a permanent sloping cover for both the influent and effluent manifolds excludes clogging debris and prevents algae development. This technique precludes periodic cleaning of a screen over the effluent manifold that would have been installed to prevent accumulation of debris.
- Bats and dragonflies contribute to mosquito control during the warm summer months, so mosquitoes and similar insect vectors have not been a health problem at this system.
- Odors occasionally noticed at the inlet end of the wetland cells are caused by accumulation of TSS and algae carried over from the final aerated lagoon cell because the settling zone in this final lagoon cell is too small to be completely effective.
- Ice cover and snow accumulation have provided acceptable thermal protection for the FWS system, and

the system has not needed alteration during the winter months. In response to State of Colorado concerns that FWS wetlands would not sustain acceptable performance during low-temperature winter months, the lagoon aeration system had been designed to allow longer operational periods during winter months to provide additional treatment so the wetland cells could have been bypassed during winter months, if necessary.

- Chlorination/dechlorination equipment included in the original design at the insistence of the State of Colorado has not been used, as the wetland effluent has been consistently below permit limits.

8.2 Vegetated Submerged Bed (VSB) Systems

8.2.1 Village of Minoa, New York

8.2.1.1 Background

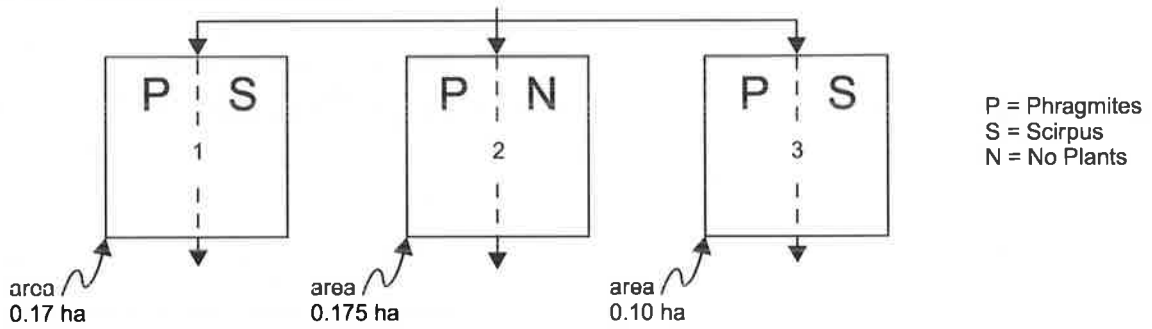
The Village of Minoa is a small residential community of approximately 3,700 in central New York state east of Syracuse. The average daily flow to the wastewater treatment plant in 1993 was approximately 0.35 mgd, but peak flows as high as 1.6 mgd had been recorded. Efforts between 1990 and 1993 to abate the high rates of infiltration and inflow were unsuccessful, and the Village of Minoa was forced into a consent order with the New York State Department of Environmental Conservation (NYSDEC) to correct discharge violations.

In 1994 the village decided to use a VSB constructed wetland system to treat primary effluent to secondary effluent standards, with an ultimate oxygen demand limit that required at least partial nitrification. The VSB system also would be used during wet weather conditions to treat 640,000 gpd of wet weather flow. The dry weather capacity of the VSB system was to be 160,000 gpd, but the actual constructed size of the system was smaller than the original design, reducing the design capacity to approximately 130,000 gpd. The treatment goal also was changed from a BOD₅ concentration of less than 30 mg/L and partial nitrification to BOD₅ alone.

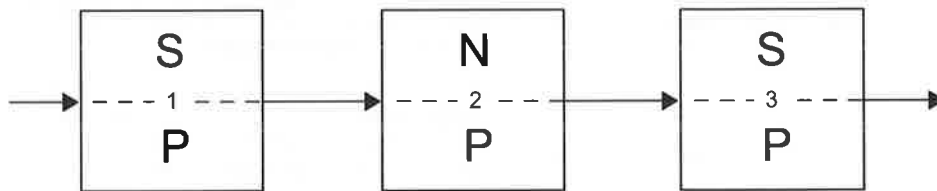
Two New York state agencies and the U.S. EPA provided grant funds to the village for incorporation of several special features in the VSB system and for a research and technology transfer study of the system by researchers at Clarkson University, Potsdam, NY.

The VSB system consists of three cells that can be operated in parallel, combined parallel and series, or series modes. Cells 1 and 2 are approximately the same size (0.17 ha or 0.42 acres). Cell 3 is significantly smaller and is irregularly shaped (0.1 ha or 0.25 acres) (Figure 8-6). At the inlet end, the media depth is 0.5 m and the bottom surface has a slope of 1%, resulting in a bed depth of approximately 0.9 m at the outlet end and an average depth of 0.76 m. The upper 7.6 cm of the beds consist of 0.6 mm pea gravel, which allowed for the establishment of wet-

a) Period One - Continuous Flow in Parallel



b) Period Two - Fill and Drain Flow in Series



c) Period Three - Combination Sequence (fill and draw [1 and 2] to continuous 3)

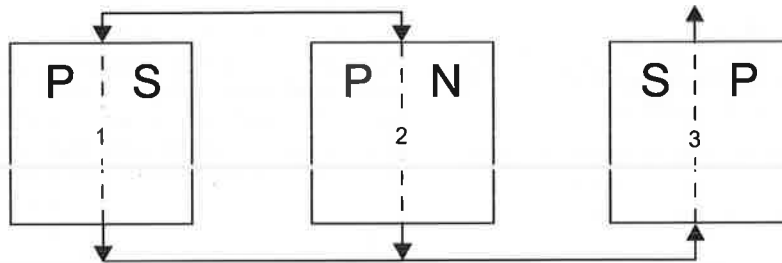


Figure 8-6. Schematic of Minoa, NY, VSB system

land plants. The larger treatment media have an effective size of approximately 1.9 cm and a measured porosity of 0.39. The cells are lined with a 60-mil HDPE liner.

Each cell is divided in half longitudinally by an extension of the liner to the top of the media. Three of the half cells were planted with Phragmites, two of the half cells were planted with Scirpus, and the final half cell was left unplanted. This planting scheme allowed for performance comparisons of planted versus unplanted cells and Scirpus versus Phragmites. The system is depicted in Figure 8-6.

In addition to the multicell design and multiple operational modes, the VSB system at Minoa incorporated several other special features, including trilevel observation

well clusters within each half cell, specially designed inlet weirs, thermistors beneath one of the cell liners and at various levels within the cell, a dual-level effluent withdrawal, and an adjustable water-level control.

The specific goals of the research/technology transfer efforts were the following:

1. Establish optimum hydraulic, organic, and solids application rates necessary to achieve Village of Minoa NPDES permit limitations.
2. Conduct testing to determine the impact of wet-event peak-day hydraulic impacts on treatment performance. One of the project objectives was to evalu-

ate the performance of the system under the maximum hydraulic design condition of 640,000 gpd.

3. Conduct tracer dispersion testing to measure actual bed HRT and "in-place" hydraulic conductivities, to evaluate impacts due to clogging, and to determine the extent of short-circuiting.
4. Correlate ambient and wastewater temperature data with observed removal efficiency for BOD, UOD (Ultimate Oxygen Demand), and ammonia nitrogen.
5. Evaluate the effect of plants (vs. no plants) and specific plants (*Scirpus* vs. *Phragmites*) on treatment performance.
6. Evaluate the effect of vegetative harvesting on nutrient removal efficiency.
7. Provide data for calibrating an existing VSB heat-loss model that predicts the substrate temperature at various locations in the system.
8. Evaluate effects of series- versus parallel-flow configurations on treatment performance.
9. Conduct a detailed energy audit to establish the energy benefits of this system in comparison with a conventional treatment approach.

Construction costs for the system are summarized in Table 8-7. It should be noted that (1) the work at Minoa was completed under adverse weather conditions and a tight construction schedule because of the consent order requirements, and (2) costs reflect all of the special features incorporated in the system for research.

8.2.1.2 Financial Arrangements

The costs of the Minoa wetland system associated with the research aspects of the project were funded by the U.S. EPA and the two State of New York agencies. The remaining capital costs of the project were funded with a state revolving-fund loan under the innovative and alternative system program.

8.2.1.3 Construction and Start-up Procedures

As noted previously, the work at Minoa was completed under adverse weather conditions and a tight construction schedule because of the consent order requirements. During the establishment of the wetland plants throughout most

of 1995, the wetland cells received only secondary effluent from the existing trickling filter.

8.2.1.4 Performance History

The performance of the Minoa VSB system in treating primary effluent can be divided into three periods. During the first period of January 1996 to March 1997, the system was operated as a conventional VSB system, with the three cells in parallel. From April 1997 to March 1998, the three cells were operated in series and in a sequential fill-and-drain mode. From March 1998 to the writing of this manual, the system has been operated in a different fill-and-drain mode. Two cells, cells 1 and 2, operate in parallel but in alternating fill-and-drain mode, similar to sequencing batch reactors. The third cell, cell 3, operates in series-flow, but with a constant water level, following the other two cells.

Conventional Parallel Operation

The BOD₅ removal performance of the Minoa VSB system in the conventional mode was very poor when compared with the original design expectations. The three cells were operated in parallel flow, but with different HRTs. The performance of the Minoa system in BOD₅ removal during the first 10 months of conventional operation is summarized in several of the figures (identified as CU) in Chapter 5 and can be compared with two other systems. The false performance expectations for the system were based on a design equation developed with limited data, mostly from VSB systems treating lagoon and pond effluents. The equation assumed that BOD₅ removal performance is dependent on temperature. Pollutant removal was not found to vary significantly with temperature at Minoa.

The performance of the Minoa VSB system in TSS, TKN, and total phosphorus removal during this period was similar to the performance of other VSB systems treating septic tank effluents (see Chapter 5 figures). TSS and BOD removal were reasonably good, whereas TKN and total phosphorus removal was quite poor.

Tracer study results from Minoa were also very similar to tracer study results from other VSB systems. After one year of operation, a significant fraction of the wastewater flowed under the shallow root zone of the system. Also observed were substantial dead volumes and typical amounts of dispersion within the media.

Comparing the treatment performance of planted and unplanted half cells, the Clarkson researchers found that the unplanted half-cell performance was equal to the planted cells for all pollutants measured. They also found that the *Phragmites* cells removed more COD, TKN, and total phosphorus than the cells planted with *Scirpus*.

Series-Flow, Sequential Fill-and-Drain Operation

The three cells of the Minoa VSB system were operated in series-flow, sequential fill-and-drain operation for approximately 12 months. The operation during this time made use of the dual effluent piping to achieve the fill-and-drain

Table 8-7. Village of Minoa VSB Construction Costs (Fall, 1994)

Sitework	\$135,500
60 Mil HDPE Liner	82,500
Wetland Media	104,500
Wetland Plants	29,000
Piping & Distribution	179,000
Miscellaneous	25,500
Total	\$568,000

operation, even though the flow through all three cells was continuous. The water surface in a cell was controlled by opening and closing the bottom drain line valve. When the drain valve was closed, effluent from a cell flowed through the upper effluent piping.

A typical cycle started with wastewater flowing through a filled cell 1. The drain valve in cell 1 was opened while drain valves in the other cells 2 and 3 were closed. Twenty-four hours later, the drain valve in cell 1 was closed and the drain valve in cell 2 was opened. After 24 hours in this configuration, the drain valve in cell 2 was closed and the drain valve in cell 3 was opened. It should be noted that this mode of operation was possible at Minoa because of the significant drop in elevation from cell 1 to Cell 3. At a flow rate of 130,000 gpd, the draining of cells 1 and 2 from their upper levels would take four to five hours, while cell 3 required only three hours. In filling, cells 1 and 2 would require 24 hours, while cell 3 required 12 hours.

The performance in BOD₅ removal during the sequential fill-and-drain operation was significantly better than during the previous period of conventional operation. Effluent BOD₅ averaged less than 15 mg/L while the system was treating a much higher flow, and performance improved during the latter months of the period. TSS removal was also good, but TKN and total phosphorus removal did not improve significantly. One of the most important improvements in the operation of the Minoa system during this period was the reduction in the hydrogen sulfide odors that had plagued the system during the period of conventional operation.

Alternating Parallel Fill-and-Drain/Series-Flow Operation

Operation since March 1997 has had cells 1 and 2 operating in an alternating fill-and-drain mode followed by cell 3 operating in a constant-saturated mode. The pollutant removal performance for BOD₅ and TSS has remained quite good, and there has been a significant increase in nitrogen removal performance.

8.2.1.5 Lessons Learned

- Fill-and-drain operation can significantly increase the BOD₅ and nitrogen removal performance of conventional VSB systems.
- BOD₅ removal is not temperature dependent in conventional VSB systems.
- Because of the potential for severe odor problems, conventional VSB systems must be designed to have lower organic loading rates when sited near households.

8.2.2 Mesquite, Nevada

8.2.2.1 Background

Mesquite, Nevada, is located on I-15 near the Nevada-Arizona border, about 112 miles east of Las Vegas. The

original treatment system for the community included coarse screening and aerated facultative ponds followed by storage ponds and land application on 62 acres of alfalfa fields. The State of Nevada required an effluent with BOD at 30 mg/L and TSS at 90 mg/L prior to land application. The effluent at the Mesquite facility often exceeded these limits, so an upgrade was required.

A 1989 facility plan for the upgraded facility recommended an increase in total treatment capacity to 1.2 mgd, additional aerated lagoons with lagoon effluent to either overland flow terraces or a VSB, and either of these followed by rapid infiltration basins. The VSB concept was selected for this system because a free water surface (FWS) wetland would have required a larger land area, might not have been as effective for algae removal, and would have been more susceptible to mosquito problems. The design flow to the VSB was 400,000 gpd, with the remainder routed from the lagoon to the overland flow slopes. The existing facultative pond contained multiple cells, and three of these were selected for conversion to VSBs. The total VSB area was 4.7 acres.

The modified aerated lagoons were expected to produce an effluent with about 70 mg/L, and the VSB wetlands were designed to produce an effluent with 30 mg/L BOD₅ in the coldest month, which was January. The design model used for BOD₅ removal is temperature dependent, so the system was sized to produce the target effluent value during the coldest month. There were no NPDES discharge limits for the VSBs since they were designed to discharge to rapid infiltration basins and not to a receiving stream.

A schematic plan is shown in Figure 8-7 for one of the three similarly configured VSB units. Each of the three parallel units contained four parallel cells as shown on the figure. The flow path in each of the four cells averaged 50 ft, and the cell width averaged 380 ft. This configuration produces an average aspect ratio (L:W) of 0.13:1. This very low aspect ratio was selected following observation of surface flooding and related problems with VSB systems in Louisiana, Mississippi, and Oklahoma that had aspect ratios of 10:1 or more and no provision for the necessary hydraulic gradient to overcome the frictional resistance of a very long flow path. In addition to the short flow path distance provided at Mesquite, a bottom slope of 1% was provided for the cell bottoms.

8.2.2.2 Financial Arrangements

Funding for construction of this new system was provided by a combination of municipal bonds and the State of Nevada's revolving-loan fund. The total construction costs for the VSB component at Mesquite was \$515,000 (1990\$), or \$109,600 per acre, or \$1,287 per 1000 gallons of treatment capacity. The area cost is less than the \$178,000/acre (1990\$) at the comparable VSB system in Mandeville, Louisiana (see Mandeville case study), and the difference is probably due to the higher cost of rock and gravel in Louisiana. Land and liner costs for the Mesquite project were zero because existing lagoon cells were

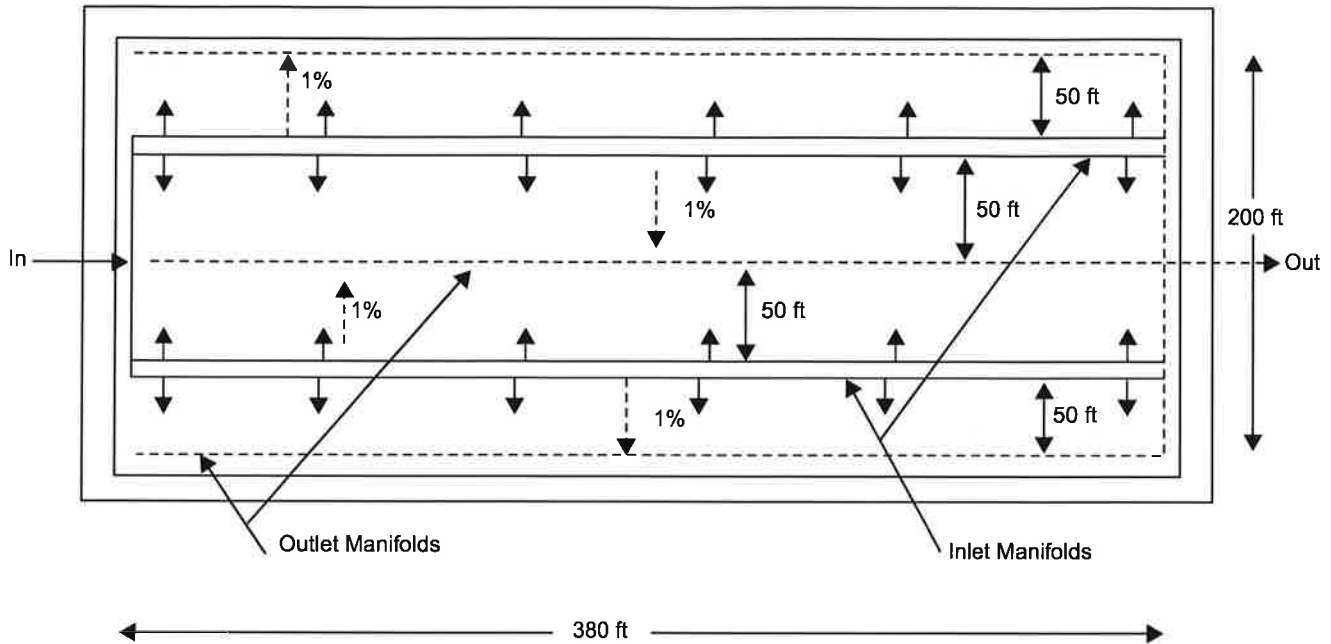


Figure 8-7. Schematic diagram of typical VSB (one of three) at Mesquite, NV

converted to VSB units. The O&M costs are funded directly by a sewer charge for each connected user; a single-family connection would pay approximately \$8.63 per month for this service.

8.2.2.3 Construction and Start-up Procedures

Construction of the new system components was completed in late 1990 and start-up occurred in April 1991. The original lagoon cells were lined with asphaltic concrete. These were prepared for the new VSB units by draining and drying, and then placement and compaction of local clay soil backfill to a depth of about 2 ft. This backfill was then graded to provide the desired 1% slope for the bottom. This 2-ft of compacted soil also ensured the impermeability of the bottoms. The effluent manifolds were placed and leveled on the bottom prior to gravel bed construction. Gravel for the bed was transported from the local pit, dumped in the wetland cell, and spread with a small bulldozer. Trenches for the coarse inlet zone rock were excavated and backfilled after placement of the entire 32-in-deep gravel layer. The 2-in layer of fine gravel/coarse sand was then placed on the surface of the bed, with the exception of the inlet and outlet zones. Posts were then driven into the gravel layer for support of the distribution manifold pipes. Construction of external piping, outlet structures, and pumping stations then completed the work.

Flow distribution to the three VSB units utilized orifice plates to split the flow, and 8-in perforated pipe manifolds were used in each cell for both distribution and effluent collection, as shown in Figure 8-7. The influent pipes were elevated slightly above the bed surface, and the effluent

manifolds were at the bottom of the bed. The main VSB bed consisted of a 32-in depth of washed river gravel ranging in size from 0.4 in to 1.0 in obtained at a local gravel pit. An inlet zone underneath each inlet pipe contains 2-in to 4-in rock to ensure rapid infiltration and distribution. This zone is about 3 ft wide at the top and extends the full depth of the bed. The gravel in the main bed was then covered with about a 2-in layer of fine gravel/coarse sand mixture to aid in the germination and growth of the vegetation.

There were no soils or geotechnical investigations at this site since existing lined lagoon cells were to be used for the new VSBs. The only geotechnical activity involved with this project was to find a suitable source for the rock and gravel required. The layer of fine gravel/coarse sand was chosen because the intended method of planting was hydroseeding. A layer of fine gravel/coarse sand mixture was placed on top of the gravel in the VSB cells to serve as a growth substrate for the intended hydroseeding. The first bed was hydroseeded in July 1991 at a rate of 25 lb/acre of seed mixed with 2500 lb/acre of mulch fiber. Sprinklers were then used to periodically flood the surface of the bed to encourage germination and growth. By September 1991, only 20% germination could be observed. Alkali bulrush (*Scirpus robustus*) was selected as the sole vegetation type for all of the VSB cells. Again hydroseeding was attempted but proved not to be successful. Planting by hand with locally available plant materials (from ditches, etc.) was successfully completed during the second year of system operation. In 1997, the VSB cells were completely covered with healthy vegetation. There is no har-

vesting or other vegetation- management procedures at this site.

Water-level control in two of the three VSB units is provided by overflow weirs in the outlet structures. In the third unit, water-level control depends on float-switch settings for the discharge pump. In addition, the piping and distribution and collection system were designed to operate with a continuous 0.4 mgd recycle flow (100% of forward flow).

As of August 1997, an additional plant expansion was underway at the Mesquite system. The city is growing rapidly as a retirement/recreational community and a number of golf courses are under construction or planned. To provide irrigation water for these golf courses, the wastewater plant expansion is including an oxidation ditch with nitrification/denitrification capability and UV disinfection to meet the necessary bacterial limits for golf course irrigation. The VSB/overland flow/rapid-infiltration units at Mesquite will remain in stand-by use and will be operational during high-flow winter months.

8.2.2.4 Performance History

The inlet orifice plates were provided to split the influent flow proportionally to the surface area of each VSB unit since there were slight variations in the size of the three units. Table 8-8 presents average VSB performance data during the period June 1992 through May 1993. Data are not available on the performance of individual units or cells within a unit.

Although the system met its effluent BOD target on an annual average basis, there were monthly variations, as shown in Table 8-9. However, these excursions had minimal impact on the rapid-infiltration system.

These 1992–1993 performance results were achieved without recycling VSB effluent. However, at the time of the 1997 site visit, recycle at 400,000 gpd was practiced continuously and produced essentially the same performance results shown in the tables. Recycle was only considered to be essential in the very hot and dry summer months in order to keep the plants on the beds alive and functional.

In the general case, algae forms in the lagoon and is separated in the VSB, and the decomposition of the algae releases additional ammonia and organics. As a result, the effluent ammonia and organics are elevated due to internal loading during the warmest periods. Removal during the warmer months of the year is believed to be offset

Table 8-8. Summary Performance, Mesquite, Nevada, VSB Component, June 1992-May 1993

Parameter	Influent, mg/L	Effluent, mg/L	% Removal
BOD ₅	64	29	55
TSS	57	13	77
NH ₄ -N	16	10	38
TKN	29	16	46
TP	7.4	6.2	16

Table 8-9. Effluent Characteristics, Mesquite, NV, VSB Component, June 1992-May 1993

Month	Temp. °C	BOD mg/L	TSS mg/L	NH ₄ -N mg/L	TKN mg/L	TP mg/L
1992						
Jun	21.6	32	6	3.3	6.7	5.0
Jul	26.7	24	6	4.3	6.4	5.3
Aug	27.1	26	6	4.5	7.6	4.8
Sep	23.6	22	5	4.1	6.8	5.5
Oct	19.1	37	5	3.3	5.6	6.1
Nov	13.5	32	22	5.3	8.6	5.8
Dec	7.5	27	16	15.7	22.3	4.7
1993						
Jan	8.1	24	14	19.8	29.7	6.1
Feb	12.7	24	18	21.9	29.9	8.0
Mar	13.9	23	16	22.1	29.9	9.2
Apr	16.2	49	17	12.4	23.6	7.1
May	20.3	27	21	6.0	9.5	7.0

by plant uptake during the growing season. Subsequent data would be very useful to help identify the annual cycle over several years.

8.2.2.5 Lessons Learned

- The wetland configuration and cross section shown in Figure 8-7 were designed to maximize the available area in the former lagoon cell, while at the same time minimizing the aspect ratio.
- Surface overflows are due to improper hydraulic design rather than clogging.
- Subdividing each VSB into four separate cells with the right slope in each cell to ensure proper flows required very careful grading of subgrade soils that significantly increased the cost and complexity of construction.
- Subdividing each unit into two cells by applying influent along the centerline and collecting effluent along the two sides would have produced an aspect ratio of 0.26:1.
- Converting each former lagoon cell to a single wetland bed, with application along one long side and effluent collection along the opposite side, would have produced an aspect ratio of 0.5:1, with a level subgrade and the water level and hydraulic gradient controlled by an adjustable outlet.
- Continuously flooding the bed with a few inches of water after hydroseeding, rather than intermittently wetting it, may have improved germination, as would planting in a more moderate season in the desert climate.
- Hand planting of shoots or rhizomes in the gravel of a VSB system is preferred. Potted shoots and rhizome material for a wide variety of plant species are commercially available.
- An effluent recycle feature permitting 100% recycle is not typical at most VSB systems and was not necessary for water quality purposes.

- Routine maintenance requirements at this system are minimal and consist of periodic pump inspections and monthly cleaning of orifices in the influent distribution manifolds.

8.2.3 Mandeville, Louisiana

8.2.3.1 Background

Mandeville, Louisiana, is located on the northern shore of Lake Pontchartrain at the end of the causeway bridge from New Orleans. The 1997 population of Mandeville was about 10,000, and the suburban residential community was expanding rapidly. A vegetative submerged bed (VSB) was selected as a component in the new wastewater treatment facilities at the recommendation of the State of Louisiana and the U.S. EPA Region VI. The system was constructed during 1989 and placed in operation in February 1990, with a design flow of 1.5 mgd. The system discharges to Bayou Chinchuba, which drains to Lake Pontchartrain. The NPDES limits are BOD₅ 10 mg/L, TSS 15 mg/L, NH₃/NH₄ 5 mg/L, fecal coliform 200/100 mL, and a maximum pH of 9.

The new system was constructed at the site of the community's original three-cell facultative lagoon, and one of the original cells was retained for temporary treatment and later abandoned at the completion of the new system. A second original cell was deepened and converted to a partial-mix aerated lagoon with three cells operated in se-

ries and submerged perforated tubing in the first two cells. The hydraulic residence time (HRT) in this new lagoon was about 15 days at design flow. The third original lagoon cell was converted to a three-cell VSB gravel bed. The VSB cells operate in parallel. Other new elements in the system included a headworks containing a bar screen and grit chamber, final disinfection with UV, and an effluent pumping station. All of these major system components are shown in Figure 8-8.

At the time this system was designed, sizing criteria were 5 acres per mgd of design flow, a one- to two- day HRT in the VSB, and an aspect ratio (L:W) of at least 10:1 to ensure plug flow conditions. These criteria assumed that the VSB influent would contain about 30 mg/L of BOD₅ and TSS following treatment in the aerated lagoon. All of these criteria were applied at Mandeville except the 10:1 aspect ratio, which could not be used due to the preexisting configuration of the facultative lagoon cell. The average aspect ratio of the three VSBs is about 2.5:1.

The three VSBs are separated by low internal earthen berms that provide about 1.5 ft of freeboard above the gravel surface in the bed. The external berms are the pre-existing dikes of the former facultative lagoon. The bottom surface area is 6 acres. The VSB bed is composed of a 1.5-ft depth of crushed limestone rock (2- to 4-in size) overlain by 6 in of granite gravel (0.5- to 1-in size). The surface layer of gravel was considered necessary as a rooting

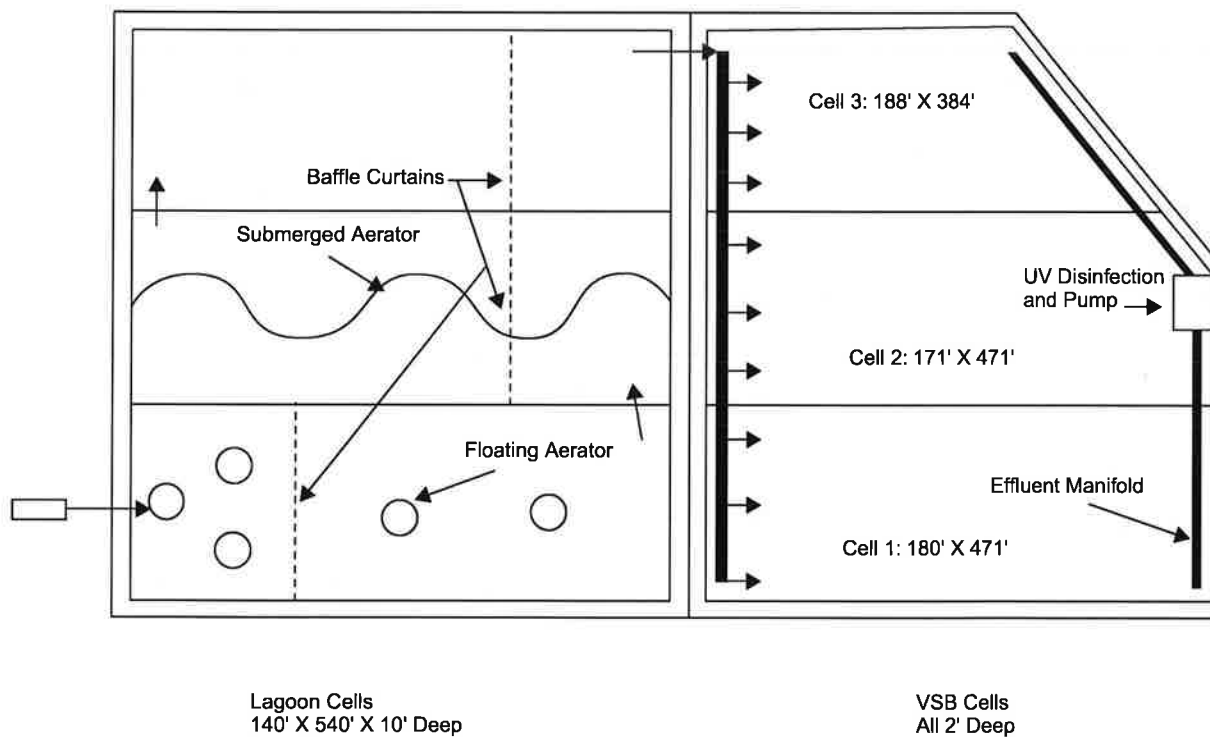


Figure 8-8. Schematic of VSB system at Mandeville, LA

medium for the vegetation. Softstem bulrush (*Scirpus validus*) was selected as the sole vegetation type, and nursery-grown shoots were planted on about 4-ft centers. An annual harvest of these plants was recommended by the designers and was practiced for several years after start-up.

A 20-in PVC pipe conveys lagoon effluent to the VSB. This pipe connects to a PVC manifold extending the full width of the three cells. At three equidistant points in each cell, the manifold discharges to a 10-in outlet pipe that is valved and extends 25 ft into the bed. These outlet pipes are at the surface of the bed, and they each end in a 90° "down" elbow that penetrates into the rock layer. These nine gate valves were intended for flow control so that a cell could be taken out of service and/or flow could be adjusted as required to produce a relatively uniform distribution of flow.

The effluent manifold for cells 1 and 3 is 21-in PVC and 24-in PVC for cell 2. These manifold pipes were buried with the top of the pipe flush with the top of the coarse rock layer. Four-in-diameter holes were drilled on 8-in centers at the top center of these manifold pipes. These manifolds connect to the UV disinfection chamber, which then discharges to the sump of the discharge pump. The top of the gravel layer was graded level, as was the bottom of the bed, and no adjustment was possible in the water level in the bed, nor was it possible to drain the cells.

A special feature in all three wetland cells is the inclusion of buried 6-in perforated PVC pipes. Two of these open-ended pipes are buried in each cell, about 6 in above the bed bottom in the coarse rock media. Their apparent purpose is redistribution of subsurface flow in case the entry zone of the bed becomes clogged with solids. Each pipe is 100 ft in length and is laid parallel to the flow direction; the two pipes in each bed are located about 35 ft on each side of the longitudinal bed centerline.

The construction costs for the entire system, including the aerated lagoons, was about \$3,000,000 (1990\$). The cost for the VSB cells was about \$590,000 (1990\$), with about 70% of that for procurement and placement of the rock media and gravel layer. The materials used at Mandeville were barged from Arkansas, since rock and gravel are not readily available in this part of Louisiana. Other VSB projects in the vicinity have used rock and gravel barged from Mexico. The VSBs are not lined since the subsoils are clay and sandy clay. Since the exterior dikes for the former lagoon were utilized, construction costs were minimal (except for the cost of rock and gravel). Land costs were zero since the preexisting lagoon was municipally owned. The construction costs for this VSB were about \$590 (1990\$) per 1000 gallons of design flow, or \$105,400 per acre of treatment area for the 5.6-acre system.

8.2.3.2 Financial Arrangements

The construction costs for the Mandeville system were funded privately through bonds issued by the City of

Mandeville. No grant or funding support was provided by the State of Louisiana or the U.S. EPA. The apparent reason was the relatively low position of the city on the grant priority list. The city, faced with the choice of curtailing community growth or funding a new system itself, chose the latter option. The O&M costs for the system have been obtained as a surcharge on the consumer's water bill.

8.2.3.3 Construction and Start-up Procedures

Construction activities commenced with draining of the existing facultative lagoon. The bottom was allowed to dry, and then accumulated sludge was removed and disposed of. The bottom was then leveled in preparation for backfilling with gravel. The concrete structures containing the UV disinfection components and the effluent pump station were also constructed at this time. The low interior earthen berms were then constructed to divide the lagoon cell into three parallel units. These interior berms permit foot traffic only. The rock and gravel were hauled by truck from the barge dock on Lake Pontchartrain to the site, dumped into the bed, and spread with small bulldozers. The entire coarse rock layer was placed and leveled before any gravel was placed as the top layer. The inlet and outlet manifolds were then installed and connected and rock backfilled around them (the top gravel layer was not placed in these inlet and outlet zones). The bed was then filled with water (with effluent from the temporary lagoon) to the top of the coarse rock. The bulrush shoots, obtained from a nursery in Mississippi, were planted by hand on 4-ft centers, with their roots in contact with the water at the top of the coarse gravel. About 15,000 plants were planted in the three cells.

Start-up of this system commenced immediately upon completion of construction. In some systems of this type, clean water is used to initially fill the bed, and the plant shoots are allowed to grow for four to six weeks prior to introduction of wastewater. In this case, lagoon effluent was introduced during the planting stage, and daily flow through the VSB commenced as soon as the aerated lagoons were operational. There were no special start-up procedures used at this site. However, a unique maintenance procedure was adopted for several years, which started with harvesting of weeds to encourage growth and spread of the bulrush, which evolved into a complete annual harvest of all vegetation and the removal and disposal of the harvested material. That practice has now been terminated.

8.2.3.4 Performance History

In 1991, the Mandeville system was selected by the U.S. EPA for a detailed eight-week performance evaluation. This effort included independent flow metering of system influent, VSB influent and effluent, tracer studies to verify HRT, and weekly composite sampling and testing for BOD (total and soluble), COD (total and soluble), TSS, VSS, TKN, NH₄-N, NO₃, TP, DO, pH, and temperature. The study period commenced in mid-June 1991 and was completed by late September 1991. The average flow rate during this period was 1.16 mgd, indicating that 77% of the system design capacity was achieved in the second year of op-

eration. This is a reflection of the very rapid growth and residential construction in the community. A summary of the water quality performance data is given in Table 8-10. The tracer study, conducted only in cells 2 and 3 because the valves for cell 1 had been inadvertently closed, measured a flow rate of 1.352 mgd, which indicated an actual HRT of 17.8 hours. This compared favorably with the theoretical HRT of 18 hours for the same flow rate, assuming a porosity of 42% in the rock/gravel bed. At the time of the tracer test, surface water was apparent on portions of the wetland cells, but the majority of the flow was subsurface. If cell 1 had been operational during the test, it is believed that the actual HRT would have been close to the one-day theoretical HRT for the full system.

Table 8-11 presents a summary of system performance data collected in 1996 and 1997. The values shown are the averages for the month shown.

As shown in Table 8-11, the current actual flow exceeds the original design rate of 1.5 mgd, but the system continues to meet the discharge limits for BOD and TSS but exceeds the ammonia limit on a seasonal basis (i.e., non-compliance in the colder months). The routine compliance with BOD₅ and TSS limits is in part due to the reliability of these systems for removal of these parameters, but is also in part due to significant modifications to the system made in 1992. The present system configuration, with the surface aerators, the subsurface aerators, and the baffle curtains as shown in Figure 8-8, has been in place since 1992. The lagoons as originally constructed had submerged, partial-mix aeration tubing in the first and second aeration cells, and there were no baffles in place. In effect, the first baffle in the first lagoon cell converts the entry zone into a complete-mix aeration component. The purpose of these modifications was to obtain a more rapid removal of BOD₅ and more effective settling of TSS in the lagoons, and to subsequently permit more effective ammonia removal in

the lagoons and VSB component. This strategy has been successful for BOD₅ and TSS, but not for ammonia. The low ammonia values obtained in the EPA study during the 1991 summer are misleading. The records for the entire year show a seasonal trend in effluent concentrations that are similar to those shown in Table 8-11 for 1996–1997. In 1991, the effluent ammonia concentration averaged 3.2 mg/L during the warm months (March–November) and 7.8 mg/L during the colder months (December–February). The system met the ammonia limit by a significant margin during that first year of operation.

There are no significant seasonal trends in the ammonia concentration in the untreated wastewater, but there are in the lagoon effluent, which indicates that these higher winter values are not treated effectively by the VSB. As a result, the system effluent exceeds the discharge limit. This condition suggests that the lagoon, as presently configured, does not provide effective nitrification during the colder weather. That is a plausible hypothesis since the nitrifier organisms are temperature sensitive and generally exist in relatively low numbers in these partial-mix aerated lagoons with no sludge return.

The city intends to increase the capacity of the system to about 4 mgd to keep up with expected growth in the community. Discussions are underway regarding the future system configuration to solve both the ammonia problem and permit capacity expansion with maximum utilization of the existing facilities.

8.2.3.5 Lessons Learned

- The internal hydraulics of the wetland cells force all of the influent to enter the cell at three points, with a total cross-sectional area of about 2 ft², which is inadequate to receive a design flow of about 350 gpm and results in surface flow in the inlet zone. A perforated inlet manifold that extended the full width of each cell should have prevented surface flow. At the effluent end of the cells, surface flow was caused by outlet ports installed at the same elevation as the rock surface.
- A means of controlling water levels in the bed and allowing the bed to be drained for maintenance would have improved the system.
- Modifications to the system, including additional orifices drilled in the effluent manifold in the side and lower quadrant, additional surface gravel placed in the area of the manifold, and a new pipe installed to permit drainage of the cells, resulted in a lowering of the water level in the effluent zone of the wetland bed, so the gravel surface in that area is generally dry.
- Surface flow was experienced almost immediately in the inlet and outlet zones of this system and was not caused by clogging, as confirmed by EPA investigations in 1991, but rather by lack of hydraulic gradient.
- Hydraulic gradient for a flat-bottomed system can be provided with a water-level control device at the effluent end of the cell.

Table 8-10. Water Quality Performance, Mandeville LA Treatment System, June/September 1991

Parameter	System Influent	Wetland Influent	Wetland Effluent
BOD (Total) mg/L	154	41	10
BOD (Soluble) mg/L	ND ¹	21	8
COD (Total) mg/L	349	79	43
COD (Soluble) mg/L	ND	40	31
TSS mg/L	132	59	7
VSS mg/L	ND	39	5
TKN mg/L	ND	5	3
NH ₄ -N mg/L	ND	1.4	2.1
Organic N mg/L	ND	3.1	1.1
NO ₃ -N mg/L	ND	4	0.2
TN mg/L	ND	9	3
TP mg/L	ND	3	4
Fecal Coliforms#/100ml	ND	TNTC	TNTC ²
DO mg/L	ND	2.4	1.8
pH	6.9	6.9	7.0
Temperature °C	ND	31.8	30.5

¹ND = No data available.

²TNTC = Too numerous to count, sample taken prior to disinfection

Table 8-11. Water Quality Performance, Mandeville, LA, Treatment System, 1996 -1997

Date	Avg. Flow mgd	Raw Wastewater			Wetland Influent			Wetland Effluent		
		BOD mg/L	TSS mg/L	NH ₄ -N mg/L	BOD mg/L	TSS mg/L	NH ₄ -N mg/L	BOD mg/L	TSS mg/L	NH ₄ -N mg/L
1996										
Jan	1.57	133	115	14	15	8	14.3	5	2	11.9
Feb	1.60	156	120	15	14	8	14	6	2	12
Mar	1.75	126	116	13	16	11	16	2	2	11
Apr	1.26	145	148	14	11	8	12	4	1	8
May	1.11	137	133	18	45	25	10	3	2	9
Jun	1.72	138	132	18	27	18	1	2	2	0.5
Jul	1.33	131	115	16	24	24	1	2	1	0.7
Aug	1.71	64	70	20	30	48	7	10	7	5
Sep	1.32	61	155	31	59	20	12	9	7	5
Oct	1.69	86	137	21	43	18	14	7	4	5
Nov	1.51	119	126	44	62	8	8	8	5	4
Dec	1.57	116	122	37	43	11	28	6	2	19
Avg	1.51	118	124	22	32	17	11	5	3	8
1997										
Jan	1.85	89	111	20	70	14	12	7	4	7
Feb	2.31	63	94	24	62	23	44	10	6	20
Mar	1.53	94	128	26	59	16	16	7	3	5
Apr	1.44	97	98	22	52	20	10	6	4	4
May	1.67	112	140	25	34	14	6	4	3	4
Jun	1.64	93	167	28	57	10	12	4	3	4
Jul	1.68	108	109	16	51	9	9	6	2	5
Avg	1.73	94	121	23	55	15	16	6	4	7
Weighted Average 1996/97	1.59	109	123	22	40	16	13	5	3	8
1991	1.16	154	132	ND	41	59	1.4	10	7	2.1

- Bulrush planted in this system has attracted nutria and muskrat, which favor bulrush for food and nesting material. Nutria have eaten most of the bulrush plants and bored through the interior berms, which causes significant leakage between the cells. Small sacks filled with a mixture of cement and sand have corrected the leakage problem of nutria boring through interior berms.
- The minimal availability of oxygen in VSB wetland beds makes them ineffective for nitrification of ammonia, and the Mandeville system can meet ammonia discharge limits only when the aerated lagoon provides sufficient ammonia removal.

8.2.4 Sorrento, Louisiana

8.2.4.1 Background

Sorrento, a small residential community in southeastern Louisiana, is located about 50 miles southeast of Baton Rouge. Prior to construction of the aerated lagoon wetland system, the community was served by on-site septic tank systems. Many of these on-site systems were not functioning properly due to the difficult soil conditions in the area. The new system was designed in 1990 and placed in operation in late 1991. The lagoon component consists of two 10-ft-deep aerated cells (first cell contains four 3-hp floating aerators, second cell contains four 2-hp floating

aerators), followed by a 7-ft-deep settling pond. The two aerated cells were designed for 10 d HRT at the potential ultimate flow rate of 130,000 gpd. At the 1997 flow rate of 32,000 gpd, the HRT is about 40 d, and only a few of the aerators were operated.

The VSB cell, with a bottom area of about 7800 ft², was designed for a flow rate of 50,000 gpd with the intention of adding a second parallel cell as the flow rate increases in the future. The design HRT in this bed at 50,000 gpd would be one day. The native soils are clays and silty clays, so the bottoms of the lagoon cells and the VSB cells are not lined. However, a geotextile liner is used on the inner slope of all berms to prevent erosion and weed growth; the outer slope of these berms is grassed. The system discharges to Bayou Conway, and the NPDES discharge limits are BOD₅ 20 mg/L, TSS 20 mg/L, pH 6–9, and fecal coliforms 200–400/100 mL. There are no ammonia limits for this system.

As shown in Figure 8-9, the VSB cell is triangular in shape, with the inlet zone about 60 ft wide and the flow path to the outlet about 250 ft long. This shape was selected to minimize short-circuiting of flow. Previous designs had large aspect ratios (10:1 or greater) but insufficient hydraulic gradient to overcome the frictional resistance, resulting in surface flow on top of the bed. At Sorrento, the average aspect ratio is only 6:1, but all of the flow converges at the end of the triangular bed.

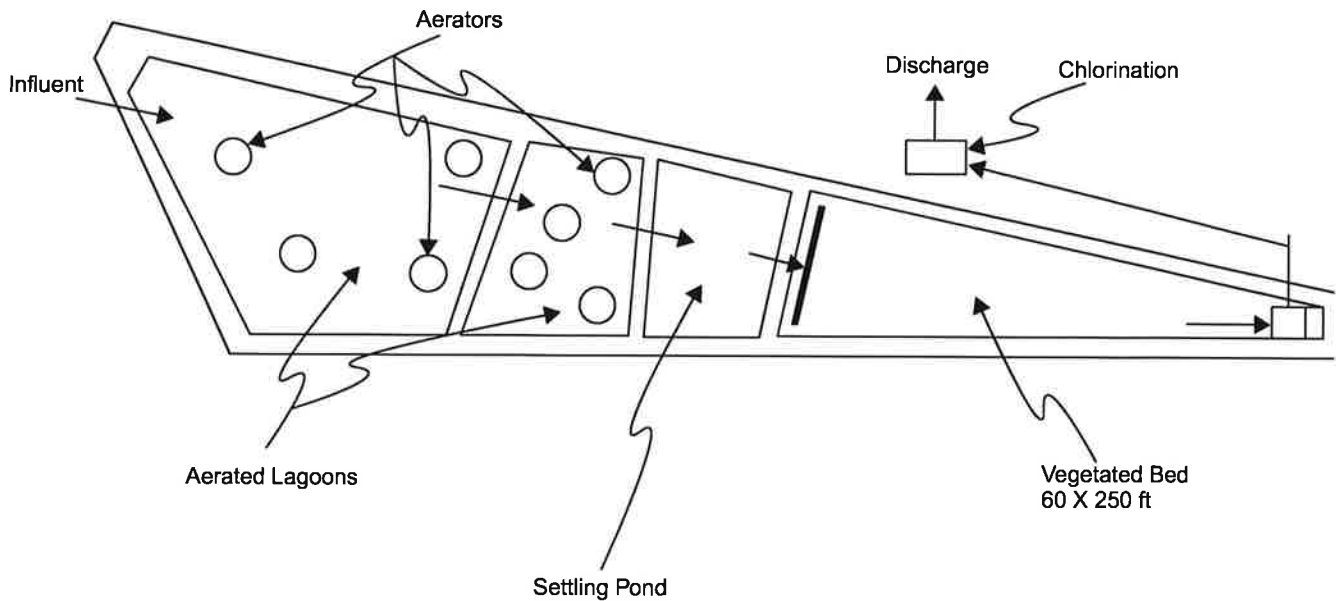


Figure 8-9. Schematic of VSB system at Sorrento, LA

The design engineer of the Sorrento system also incorporated several features to ensure that an adequate hydraulic gradient would always be available based on lessons learned from other systems. The bottom of the bed is flat and level throughout its length, but the gravel depth is 3 ft at the inlet and 2.5 ft at the outlet, so the top surface of the gravel slopes to provide for 0.5 ft of headloss. In addition, the single outlet structure contains an adjustable sluiceway gate that allows a further increase in the available hydraulic gradient by adjusting the water level in the bed. The inlet to the bed is an 8-in perforated pipe resting on the bottom of the bed and extending the full width. The bed effluent discharges to a concrete outlet box. There is also an 8-in valved drain pipe at the outlet end of the bed to drain the cell completely, if necessary. A chlorine contact chamber is provided for disinfection prior to final discharge.

Two layers of aggregate are used in the Sorrento VSB. The top layer is a 6-in depth of washed, 0.75-in gravel. The main part of the bed is composed of crushed limestone imported from Mexico, ranging from 1.5 to 3 in in size. Since ammonia removal was not required and because maintenance problems with vegetation were apparent at other systems, it was decided not to plant vegetation on the Sorrento VSB cell. At the time of the 1997 inspection for this report, weeds were growing around the fringes of the wetland bed, but the general bed surface was still free of vegetation.

This wetland system was selected for use at Sorrento because the facility planning evaluation showed it to be the most cost-effective process for meeting the NPDES discharge requirements. The total construction cost for the

entire system was about \$233,400 (1991\$), with an estimated \$75,000 for the VSB component. The unit construction cost for the VSB would then be about \$1500 per 1000 gallons of design capacity (for the 50,000 gpd design flow). On an area basis, the capital costs would be about \$419,000 per acre for the 0.18-acre VSB.

8.2.4.2 Financial Arrangements

The construction costs for the Sorrento system were funded with federal and state money provided under the U.S. EPA Construction Grant Program that existed at that time. The O&M costs for the system are supported by sewer fees from the connected users.

8.2.4.3 Construction and Start-up Procedures

A site for the new lagoon/wetland system was identified on available land between the community and the final discharge point to Bayou Conway. Geotechnical investigations were undertaken to identify and characterize the in situ soils. These proved to be clays and silty clays that would provide adequate protection for ground water. There also was no identified risk of ground water intrusion or surface water flooding at this site.

The site is relatively level, so the entire system was excavated, with excess material used to construct the berms. A 3-ft freeboard was provided for the lagoon cells and the VSB component. The rock and gravel were hauled by truck from a barge dock on the Mississippi River, dumped into the bed, and spread with a small bulldozer. The entire coarse rock layer was placed and leveled before any gravel was placed as the top layer. Inlet and outlet manifolds were then installed and connected and rock backfilled around

them. The bed was then filled with effluent from the lagoon to the top of the coarse rock. Since vegetation was not used on this system, start-up was immediate.

Routine maintenance procedures include servicing of the lagoon aerators and the chlorine disinfection equipment; there are no routine maintenance requirements for the wetland bed. There have been problems with nutria burrowing in the banks of the lagoon cells; however, since there is no vegetation and no exposed water in the wetland cell, these animals have not been a problem at this site. Since maintenance has not been required for the wetland cell, the O&M cost for this component is zero.

8.2.4.4 Performance History

Water quality data are not available for untreated sewage at Sorrento or for lagoon effluent entering the wetland system. The 1997 flow is estimated to be in the range of 15,000 gpd. At that rate the HRT would be about 100 d in the lagoons and 4 d in the VSB component. With such a long HRT, lagoon effluent could be expected to have a BOD₅ of less than 20 mg/L and a TSS in the same range (except for algal bloom periods). With inputs at this level, the VSB with an HRT of 4 d could be expected to produce background levels of BOD₅ and TSS, as confirmed in Table 8-12.

8.2.4.5 Lessons Learned

- The triangular configuration of this VSB system causes flow lines to converge at the end of the system in a single outlet point, which is cost effective, but any such design would need to evaluate weir loading rates per unit length to avoid excessive velocity in the outlet zone that could cause resuspension of TSS and its associated contaminants.
- The sloping surface of the gravel (0.2% grade) provides an additional 0.5 ft of potential head at the inlet

Table 8-12. VSB Effluent Water Quality, Sorrento, LA

Date	BOD, mg/L	TSS, mg/L	Fecal Coli ¹	pH
2/23/94	<6	5	0	7.2
3/31/94	<6	4	0	7.2
5/18/94	<6	2	20	7.5
7/28/94	<6	4	100	7.4
8/10/94	<6	4	0	7.2
9/26/94	<6	4	6	7.8
12/30/94	<6	4	180	7.6
1/12/95	<6	4	TNTC	7.9
3/8/95	<6	4	4200	7.9
4/28/95	<6	4	666	7.1
6/16/95	<6	11	0	7.8
7/12/95	<6	4	0	7.5
8/10/95	<6	4	0	7.3
9/13/95	<6	4	0	7.5
10/11/95	<6	4	0	7.4
11/8/95	<6	4	0	7.5
12/13/95	<6	4	53	7.4
1/24/96	<6	4	350	7.4
2/14/96	<6	1	3	7.5
3/13/96	<6	4	6	7.0

¹Note: after chlorine disinfection, #/100 ml

to help ensure that the hydraulic gradient is sufficient to avoid surface flow on the bed.

- The adjustable outlet gate provides additional water level adjustment; however, the outlet gate cannot be lowered completely, so an additional drain pipe for dewatering the bed is necessary. A completely adjustable outlet may have eliminated both the additional gravel necessary to produce the sloping surface and the drain pipe for dewatering.
- The system is oversized for the current flow rate and organic loading, so an additional VSB cell may not be necessary for the system to handle flow rate increases anticipated in the future.
- The lack of plants in this system does not appear to affect removal of BOD and TSS, as was observed in a 1992 EPA performance evaluation of a vegetated system and a temporarily nonvegetated system.
- The lack of plants in effect equates the VSB concept to a horizontal-flow, coarse-media, contact filter.

8.3 Lessons Learned

8.3.1 Design

Organic Loading

Organic loadings in the range of 10 to 25 lbs BOD/acre/day to FWS systems have been shown to effectively meet 30 mg/L BOD and TSS monthly effluent standards, with no need after 15 years of operation to remove the settled material from a FWS system. For the majority of these systems, this range of organic loading results in six to eight days of theoretical hydraulic retention.

Data Gaps

The database for both VSB and FWS systems has a continuing problem of not having enough quality-assured data to evaluate removal rates, seasonal differences, water balances, and long-term treatment effectiveness. Insufficient data have been collected on contaminant loadings (both flow and concentration), incremental data through the system (multiple data collection points), and water column data (temperature, pH, and dissolved oxygen) at different locations.

Inlet/Outlet Works

Studies comparing the placement of inlet/outlet (I/O) works as a function of cell geometry and outlet approach conditions are lacking. As a result, there is not a complete rational approach to the placement and design of inlet and outlet works for these types of systems. For example, the criterion of weir overflow rate typically has been used to place outlet weirs and specify weir length in these low approach-velocity systems. Included in the outlet design are bathymetric and vegetative conditions of the outlet zone of FWS wetlands. Large collection areas immediately upstream from outlet works that have no emergent vegeta-

tion have resulted in poor effluent quality. Relatively shallow collection zones with emergent vegetation have shown less variability of effluent quality, but more O/M requirements.

Headloss

While headloss is a factor of concern in VSB systems, it is not a major factor in FWS wetlands unless they have extremely long and narrow flow reaches. Headloss is a consideration in FWS wetlands only when L:W ratios are great (10:1 or greater) and are combined with high hydraulic loading rates in heavily vegetated cells. Proper placement of I/O works, sufficient berm height, and L:W ratios less than 10:1 minimize headloss effects in FWS wetlands. Clean-water headloss through a VSB wetland system is quickly modified as pore spaces are filled with separated solids and, to a lesser degree, rhizosphere development. Under conditions of plugging by these mechanisms, the liquid level will eventually surface and an undersized, fully vegetated FWS wetland condition will begin to develop on the surface.

Hydraulics

The internal hydraulics of a VSB system are critical to treatment success. Systems constructed with high L:W ratios, flat bottoms, and with effluent manifold ports located at the top of the gravel produced surface flow at the effluent ends of the cell. These types of systems also did not allow for water level control within the bed and cell drainage. Multiple-ported influent manifolds extending the width of the inlet zone, coupled with similar effluent collection manifolds with adjustable weirs or rotating elbows, would allow for greater hydraulic contact in the basin and more operational flexibility. Sloping the surface of the gravel bed based on the design flow headloss may also permit increases in VSB hydraulic loading and duration of service prior to major inlet maintenance.

Aspect Ratio

High aspect ratio FWS wetland cells can produce significant operational problems at high hydraulic loading rates and/or with dense stands of emergent vegetation. Headloss effects are additive and are greatly aggravated with high length-to-width ratios in totally vegetated FWS wetlands. Both types of systems with L:W ratios as high as 30:1 have produced significant flooding at the influent berms while dropping the effluent water elevation below weir recovery levels. Parallel cells with lower L:W with multiple I/O works can control this effect. The only design limitation is that the HRT must be above some minimum to assure removal of TSS and associated pollutants of concern.

Ice Formation

In colder climates where ice forms on standing water, sufficient freeboard and outlet control is essential to allow for ice formation to cap the normal operating depth of the

free surface water column. In most cases, this distance is less than 1 ft. The ability to operate the wetland with the water column directly in contact with the ice, with no lowering of the water level once the ice forms, is another important design feature. Lowering the water under these conditions could allow for a secondary ice level, with a liquid level constraint, to form under the primary level.

8.3.2 Mechanisms and Processes

Oxygen Transfer

Oxygen transfer through the rhizosphere evidently is not a major contributor to contaminant oxidation in vegetated submerged bed systems, based on both research and full-scale studies. Oxygen demand associated with storage products in roots and tubers is much greater than excess oxygen available at the root hairs and other plant parts. In FWS wetlands, epiphytes can colonize on stems and leaves preferentially depending on oxygen exuding from the gas transport plant structures.

Nitrification-Denitrification in VSB Systems

Cost-effectively sized VSB systems have not been shown to significantly nitrify treated influent. It follows that VSBs have not been shown to be able to denitrify an influent, which is predominantly ammonia. Early studies that suggested that significant amounts of nitrogen can be removed in a VSB wetland system have not been duplicated in subsequent studies and full-scale evaluations.

Plant Coverage

Coverage by emergent plants in FWS wetlands should not be 100% because too much coverage by emergent plants is negatively correlated with effluent quality. Placing open water (submergent aquatic macrophytes) between areas of closed water (emergent macrophytes) is correlated with better effluent quality than a wetland that has 100% emergence. Submergent plants release oxygen to the water column, and these open water zones allow for more surface reaeration. Emergent plants also contribute more internal BOD loading upon decomposition.

Ground Water Recharge

Siting and designing FWS wetlands with intentional discharge to ground water is a legitimate application of this treatment technology. With proper design, FWS wetlands for ground water recharge can remove nitrate nitrogen (through denitrification) and indicator organisms. Data collected at "leaky wetland sites," such as in Jackson Bottom, Oregon, have demonstrated the effectiveness of these processes in locations where soils are sufficiently porous.

Plant Litter

Plant litter is an essential component of a FWS constructed wetland. While this material contributes to flow resistance, it more importantly seals surface areas in fully vegetated zones to assure anoxic conditions.

8.3.3 Vegetation

Development of Treatment Effectiveness

The full treatment potential of a FWS system may not be realized until there is both full coverage of plants (as designed) and a layer of litter beginning to accumulate on the surface of the water. Depending on the type of plants, planting density, and time of planting, a minimum of two growing seasons, or two to three years, may be needed. This may be important when negotiating discharge permit requirements.

Ammonia Nitrogen

In VSB systems, plants are not critical to the removal of BOD and TSS, as shown in several systems. Evidence suggests, however, that they are effective in removing portions of the nitrogen and phosphorus due to uptake by the plants during the growing season. Most of these nutrients are returned to the water column during the senescent period.

Aeration

Attempts to aerate outlet zones of FWS systems with submerged tubing have resulted in attracting animals such as muskrats and nutria, which may damage the tubing.

Short-circuiting

Vegetation predation by nutria and muskrats in FWS wetlands can produce serious hydraulic short-circuiting. Varying plant resistance as the wastewater moves through the wetland also can cause short-circuiting. Preferential flow routes can develop in these systems, which have relatively low velocities.

Seeding and Germination

Hydroseeding both VSB and FWS wetlands has only been successful for cattails in some instances. Additional studies of this low-cost approach to planting are recommended. Seeding with 25 lb/acre mixed with a mulch at 2500 lb/acre have been used for VSB systems. Continuous shallow-water inundation has consistently produced higher germination rates than have sprinklers.

Plant Toxicity

Emergent vegetation species, such as cattails and bulrushes, are sensitive to deep anaerobic sludge banks. In situations with large volumes of carryover solids and malfunctioning activated sludge units, emergent vegetation in the inlet zone can die from sulfide toxicity in the rhizosphere. Wastewaters with high levels of suspended and settle-

able solids should be pretreated upstream from a wetland system through use of a settling pond.

8.3.4 Treatment Effectiveness

Nutrient Uptake

Both FWS and VSB wetlands have been shown to be unable to reduce levels of BOD, dissolved phosphorus, and ammonia nitrogen below certain minimums. This is due to internal processes in a wetland, such as the solubilization of influent settleable/suspended solids and the litter layer of aquatic macrophytes. Depending on the climate, pulses of dissolved carbon (both degradable and non-degradable), soluble reactive phosphorus, and ammonia nitrogen are taken up by the plants, and they are released during periods of active decomposition in the wetland. Colder climatic conditions with early falls, long cold winters, and warm springs will pulse these materials into the water column during the spring warm-up period.

Nitrification

Without operating in a fill-and-draw batch mode, it is not economically feasible to attain aerobic conditions in a VSB system to convert ammonia to nitrate. A VSB is anaerobic throughout most of its depth, with little opportunity for nitrifying bacteria populations to develop. Internally loaded ammonia from the decomposition of algal cells has also been shown to be a factor when attempting to use a VSB to meet ammonia standards.

Sheet Flow for Nitrification

Attempts to operate a fully vegetated FWS wetland in a shallow mode to simulate conditions of overland flow have not proven to be effective.

Measurement of Treatment Effectiveness

Most of the FWS wetlands in the NADB are used to treat high-quality influents producing low organic loading conditions. In most of these cases, the internal load is more significant than the influent load. In only a few cases with high organic loading rates were the upper limits of treatment effectiveness measured, such as Gustine, California. While many viewed Gustine as a failure, it provided well-documented data on a wide range of BOD, TSS, nitrogen, and coliform fully vegetated zone loading conditions. These data showed that the upper instantaneous BOD loadings of 150 to 200 lbs/acre/day could still result in less than 40 mg/L BOD in the effluent. Such loading rates were based on a fully vegetated FWS system and a specific wastewater, so the utility of this information is limited. For example, if a wastewater had a soluble BOD loading of this magnitude, it would not be prudent (or successful) to use a single fully vegetated cell for treatment.