

# PROJECT REPORT

**TO: ENVIRONMENTAL EVALUATION COMMITTEE**

**AGENDA DATE: August 10, 2023**

**FROM: PLANNING & DEVELOPMENT SERVICES DEPT. AGENDA TIME 1:30 PM/No.1**

Green Valley Logistics Center, Water Supply Assessment  
PROJECT TYPE: SP #21-0001, ZC #21-0005, TR #993, V #23-0007 SUPERVISOR DIST: #3  
LOCATION: 3320 Highway 86 (SR-86) APN's: 040-340-004, 006, 032, and 033  
Imperial, CA 92251 PARCEL SIZE: Approx. 285 acres

GENERAL PLAN (existing) Mesquite Lake SPA GENERAL PLAN (proposed) update

ZONE (existing) ML-I-3, ML I-2 & ML-GS ZONE (proposed) ML I-3 & ML GS

GENERAL PLAN FINDINGS  CONSISTENT  INCONSISTENT  MAY BE/FINDINGS

PLANNING COMMISSION DECISION: HEARING DATE: \_\_\_\_\_  
 APPROVED  DENIED  OTHER

PLANNING DIRECTORS DECISION: HEARING DATE: \_\_\_\_\_  
 APPROVED  DENIED  OTHER

ENVIRONMENTAL EVALUATION COMMITTEE DECISION: HEARING DATE: 08/10/2023  
INITIAL STUDY: #21-0032

NEGATIVE DECLARATION  MITIGATED NEG. DECLARATION  EIR

**DEPARTMENTAL REPORTS / APPROVALS:**

PUBLIC WORKS	<input checked="" type="checkbox"/>	NONE	<input type="checkbox"/>	ATTACHED
AG	<input checked="" type="checkbox"/>	NONE	<input type="checkbox"/>	ATTACHED
APCD	<input checked="" type="checkbox"/>	NONE	<input type="checkbox"/>	ATTACHED
E.H.S.	<input checked="" type="checkbox"/>	NONE	<input type="checkbox"/>	ATTACHED
FIRE / OES	<input type="checkbox"/>	NONE	<input checked="" type="checkbox"/>	ATTACHED
SHERIFF OFFICE	<input checked="" type="checkbox"/>	NONE	<input type="checkbox"/>	ATTACHED
OTHER		<u>Caltrans</u>		

**REQUESTED ACTION:**

(See Attached)

Imperial County Planning & Development Services  
(Jim Minnick, Director)  
801 MAIN ST., EL CENTRO, CA, 92243 442-265-1736

**EEC ORIGINAL PKG**

*Initial Study & Environmental Analysis  
For:*

**Green Valley Logistics Center Project**



*Prepared By:*

**COUNTY OF IMPERIAL**  
**Planning & Development Services Department**  
801 Main Street  
El Centro, CA 92243  
(442) 265-1736  
[www.icpds.com](http://www.icpds.com)

**August 2023**

**EEC ORIGINAL PKG**



---

## TABLE OF CONTENTS

	<u>PAGE</u>
<b><u>SECTION 1</u></b>	
I. INTRODUCTION	3
<b><u>SECTION 2</u></b>	
II. ENVIRONMENTAL CHECKLIST	8
PROJECT SUMMARY	11
ENVIRONMENTAL ANALYSIS	34
I. AESTHETICS .....	33
II. AGRICULTURE AND FOREST RESOURCES .....	35
III. AIR QUALITY .....	36
IV. BIOLOGICAL RESOURCES .....	42
V. CULTURAL RESOURCES .....	50
VI. ENERGY .....	52
VII. GEOLOGY AND SOILS .....	53
VIII. GREENHOUSE GAS EMISSION .....	55
IX. HAZARDS AND HAZARDOUS MATERIALS .....	58
X. HYDROLOGY AND WATER QUALITY .....	61
XI. LAND USE AND PLANNING .....	68
XII. MINERAL RESOURCES .....	69
XIII. NOISE .....	70
XIV. POPULATION AND HOUSING .....	70
XV. PUBLIC SERVICES .....	73
XVI. RECREATION .....	75
XVII. TRANSPORTATION .....	76
XVIII. TRIBAL CULTURAL RESOURCES .....	81
XIX. UTILITIES AND SERVICE SYSTEMS .....	83
XX. WILDFIRE .....	88
<b><u>SECTION 3</u></b>	
III. MANDATORY FINDINGS OF SIGNIFICANCE	72
IV. PERSONS AND ORGANIZATIONS CONSULTED	73
V. REFERENCES	74

---

## SECTION 1 INTRODUCTION

### A. PURPOSE

This document is a  policy-level;  project level Initial Study for evaluation of potential environmental impacts resulting from the proposed Green Valley Logistics Center Project.

### B. CALIFORNIA ENVIRONMENTAL QUALITY ACT (CEQA) REQUIREMENTS AND THE IMPERIAL COUNTY'S GUIDELINES FOR IMPLEMENTING CEQA

As defined by Section 15063 of the State California Environmental Quality Act (CEQA) Guidelines and Section 7 of the County's "CEQA Regulations Guidelines for the Implementation of CEQA, as amended", an Initial Study is prepared primarily to provide the Lead Agency with information to use as the basis for determining whether an Environmental Impact Report (EIR), Negative Declaration, or Mitigated Negative Declaration would be appropriate for providing the necessary environmental documentation and clearance for any proposed project.

According to Section 15065, an EIR is deemed appropriate for a particular proposal if the following conditions occur:

- The proposal has the potential to substantially degrade quality of the environment.
- The proposal has the potential to achieve short-term environmental goals to the disadvantage of long-term environmental goals.
- The proposal has possible environmental effects that are individually limited but cumulatively considerable.
- The proposal could cause direct or indirect adverse effects on human beings.

According to Section 15070(a), a **Negative Declaration** is deemed appropriate if the proposal would not result in any significant effect on the environment.

According to Section 15070(b), a **Mitigated Negative Declaration** is deemed appropriate if it is determined that though a proposal could result in a significant effect, mitigation measures are available to reduce these significant effects to insignificant levels.

This Initial Study (IS) is prepared in conformance with the California Environmental Quality Act of 1970, as amended (Public Resources Code, Section 21000 et. seq.); Section 15070 of the State & County of Imperial's Guidelines for Implementation of the California Environmental Quality Act of 1970, as amended (California Code of Regulations, Title 14, Chapter 3, Section 15000, et. seq.); applicable requirements of the County of Imperial; and the regulations, requirements, and procedures of any other responsible public agency or an agency with jurisdiction by law.

Pursuant to the County of Imperial Guidelines for Implementing CEQA, depending on the project scope, the County of Imperial Board of Supervisors, Planning Commission and/or Planning Director is designated as the Lead Agency, in accordance with Section 15050 of the CEQA Guidelines. The Lead Agency is the public agency which has the principal responsibility for approving the necessary environmental clearances and analyses for any project in the County.

---

## C. INTENDED USES OF INITIAL STUDY AND NEGATIVE DECLARATION

- 1) This IS and Notice of Preparation (NOP) are informational documents which are intended to inform County of Imperial decision makers, other responsible or interested agencies, and the general public of potential environmental effects of the proposed applications. The environmental review process has been established to enable public agencies to evaluate environmental consequences and to examine and implement methods of eliminating or reducing any potentially adverse impacts. While CEQA requires that consideration be given to avoiding environmental damage, the Lead Agency and other responsible public agencies must balance adverse environmental effects against other public objectives, including economic and social goals. The IS and NOP prepared for the Project will be circulated for a period of 35 days for public and agency review and comments.

## D. CONTENTS OF INITIAL STUDY

This Initial Study is organized to facilitate a basic understanding of the existing setting and environmental implications of the proposed applications.

### SECTION 1

**I. INTRODUCTION** presents an introduction to the entire report. This section discusses the environmental process, scope of environmental review, and incorporation by reference documents.

### SECTION 2

**II. ENVIRONMENTAL CHECKLIST FORM** contains the County's Environmental Checklist Form. The checklist form presents results of the environmental evaluation for the proposed applications and those issue areas that would have either a significant impact, a potentially significant impact, or no impact.

**PROJECT SUMMARY, LOCATION, AND ENVIRONMENTAL SETTINGS** describes the proposed project entitlements and required applications. A description of discretionary approvals and permits required for project implementation is also included. It also identifies the location of the project and a general description of the surrounding environmental settings.

**ENVIRONMENTAL ANALYSIS** evaluates each response provided in the environmental checklist form. Each response checked in the checklist form is discussed and supported with sufficient data and analysis as necessary. As appropriate, each response discussion describes and identifies specific impacts anticipated with project implementation.

### SECTION 3

**III. MANDATORY FINDINGS** presents Mandatory Findings of Significance in accordance with Section 15065 of the CEQA Guidelines.

**IV. PERSONS AND ORGANIZATIONS CONSULTED** identifies those persons consulted and involved in preparation of this Initial Study.

**V. REFERENCES** lists bibliographical materials used in preparation of this document.

## E. SCOPE OF ENVIRONMENTAL ANALYSIS

For evaluation of environmental impacts, each question from the Environmental Checklist Form is summarized and responses are provided according to the analysis undertaken as part of the Initial Study. Impacts and effects will be evaluated and quantified, when appropriate. To each question, there are four possible responses, including:

1. **No Impact:** A "No Impact" response is adequately supported if the impact simply does not apply to the proposed applications.
2. **Less Than Significant Impact:** The proposed applications will have the potential to impact the environment. These impacts, however, will be less than significant; no additional analysis is required.
3. **Less Than Significant with Mitigation Incorporated:** This applies where incorporation of mitigation measures has reduced an effect from "Potentially Significant Impact" to a "Less Than Significant Impact".
4. **Potentially Significant Impact:** The proposed applications could have impacts that are considered significant. Additional analyses and possibly an EIR could be required to identify mitigation measures that could reduce these impacts to less-than-significant levels.

#### F. POLICY-LEVEL or PROJECT-LEVEL ENVIRONMENTAL ANALYSIS

This Initial Study will be conducted under a  policy-level,  project level analysis. Regarding mitigation measures, it is not the intent of this document to "overlap" or restate conditions of approval that are commonly established for future known projects or the proposed applications. Additionally, those other standard requirements and regulations that any development must comply with, that are outside the County's jurisdiction, are also not considered mitigation measures and, therefore, will not be identified in this document.

#### G. TIERED DOCUMENTS AND INCORPORATION BY REFERENCE

Information, findings, and conclusions contained in this document are based on incorporation by reference of tiered documentation, which is discussed in the following section.

##### 1. Tiered Documents

As permitted in Section 15152(a) of the CEQA Guidelines, information and discussions from other documents can be included into this document. Tiering is defined as follows:

"Tiering refers to using the analysis of general matters contained in a broader EIR (such as the one prepared for a general plan or policy statement) with later EIRs and negative declarations on narrower projects; incorporating by reference the general discussions from the broader EIR; and concentrating the later EIR or negative declaration solely on the issues specific to the later project."

Tiering also allows this document to comply with Section 15152(b) of the CEQA Guidelines, which discourages redundant analyses, as follows:

"Agencies are encouraged to tier the environmental analyses which they prepare for separate but related projects including the general plans, zoning changes, and development projects. This approach can eliminate repetitive discussion of the same issues and focus the later EIR or negative declaration on the actual issues ripe for decision at each level of environmental review. Tiering is appropriate when the sequence of analysis is from an EIR prepared for a general plan, policy or program to an EIR or negative declaration for another plan, policy, or program of lesser scope, or to a site-specific EIR or negative declaration."

Further, Section 15152(d) of the CEQA Guidelines states:

"Where an EIR has been prepared and certified for a program, plan, policy, or ordinance consistent with the requirements of this section, any lead agency for a later project pursuant to or consistent with the program, plan, policy, or ordinance should limit the EIR or negative declaration on the later project to effects which:

- (1) Were not examined as significant effects on the environment in the prior EIR; or

---

(2) Are susceptible to substantial reduction or avoidance by the choice of specific revisions in the project, by the imposition of conditions, or other means."

## 2. Incorporation By Reference

Incorporation by reference is a procedure for reducing the size of EIRs/MNDs and is most appropriate for including long, descriptive, or technical materials that provide general background information, but do not contribute directly to the specific analysis of the project itself. This procedure is particularly useful when an EIR or Negative Declaration relies on a broadly-drafted EIR for its evaluation of cumulative impacts of related projects (*Las Virgenes Homeowners Federation v. County of Los Angeles* [1986, 177 Ca.3d 300]). If an EIR or Negative Declaration relies on information from a supporting study that is available to the public, the EIR or Negative Declaration cannot be deemed unsupported by evidence or analysis (*San Francisco Ecology Center v. City and County of San Francisco* [1975, 48 Ca.3d 584, 595]). This document incorporates by reference appropriate information from the "Final Environmental Impact Report and Environmental Assessment for the "County of Imperial General Plan EIR" prepared by Brian F. Mooney Associates in 1993 and updates.

When an EIR or Negative Declaration incorporates a document by reference, the incorporation must comply with Section 15150 of the CEQA Guidelines as follows:

- The incorporated document must be available to the public or be a matter of public record (CEQA Guidelines Section 15150[a]). The General Plan EIR and updates are available, along with this document, at the County of Imperial Planning & Development Services Department, 801 Main Street, El Centro, CA 92243 Ph. (442) 265-1736.
- This document must be available for inspection by the public at an office of the lead agency (CEQA Guidelines Section 15150[b]). These documents are available at the County of Imperial Planning & Development Services Department, 801 Main Street, El Centro, CA 92243 Ph. (442) 265-1736.
- These documents must summarize the portion of the document being incorporated by reference or briefly describe information that cannot be summarized. Furthermore, these documents must describe the relationship between the incorporated information and the analysis in the tiered documents (CEQA Guidelines Section 15150[c]). As discussed above, the tiered EIRs address the entire project site and provide background and inventory information and data, which apply to the project site. Incorporated information and/or data will be cited in the appropriate sections.
- These documents must include the State identification number of the incorporated documents (CEQA Guidelines Section 15150[d]). The State Clearinghouse Number for the County of Imperial General Plan EIR is SCH #93011023.
- The material to be incorporated in this document will include general background information (CEQA Guidelines Section 15150[f]). This has been previously discussed in this document.

This document incorporates by reference the Mesquite Lake Specific Plan and Mesquite Lake Specific Plan EIR (SCH# 2005021116), both prepared by the County of Imperial in 2006. The Mesquite Lake Specific Plan consists of approximately 5,100 acres located in central Imperial County, between State Route (SR) 86 on the west and SR 111 plus ¼ mile on the east and is bordered by Harris Road on the south and Keystone Road on the north. Imperial County designated the Mesquite Lake Specific Plan Area on the 1993 General Plan to provide an opportunity to develop new job-producing light, medium, and heavy industrial uses.

The overall goal of the Mesquite Lake Specific Plan is to support economic development within Imperial

---

County; and allow for heavy industrial development in an area that is away from urban conflicts and its cities through job creation in the employment sectors of manufacturing, fabrication, processing, wholesaling, transportation, and energy resource development; and create and preserve an area where a full range of industrial uses with moderate to high nuisance characteristics may locate. The Project would accommodate continuation and expansion of the Holly Sugar Plant, including the potential for an ethanol production plant for both on-site power and export; continuation and expansion of the existing alternative energy production operations; and establishment of new manufacturing uses and warehousing and distribution facilities.



---

## II. *Environmental Checklist*

---

1. **Project Title:** Green Valley Logistics Center Project
2. **Lead Agency:** Imperial County Planning & Development Services Department
3. **Contact person and phone number:** David Black, Planner, (442) 265-1736, ext. 1746
4. **Address:** 801 Main Street, El Centro CA, 92243
5. **E-mail:** DavidBlack@co.imperial.ca.us
6. **Project location:** The Project would be located on approximately 285 gross acres within Imperial County (County), California, approximately 1.25 miles north of the City of Imperial. The Project would be west of the Union Pacific Railroad (UPRR), east of SR 86 (Imperial Avenue), north of Harris Road, and south of Newside Drain Number 1-A, entirely within the Mesquite Lake Specific Plan and on land owned by Tomcat Development LLC. The Project would be within Section 31 of Township 14 South, Range 14 East, San Bernardino Base Meridian, and Assessor Parcel Numbers (APNs) 040-340-004, 040-340-006, 040-340-032, and 040-340-033.
7. **Project sponsor's name and address:** Tomcat Development LLC  
224 South 8<sup>th</sup> Street, El Centro, California 92243
8. **General Plan designation:** Mesquite Lake Specific Plan
9. **Zoning:** Mesquite Lake Specific Plan, ML GS (Mesquite Lake Government / Special Public), ML I-2 (Mesquite Lake Medium Industrial), ML I-3 (Mesquite Lake Heavy Industrial). All parcels have a Renewable Energy Overlay.
10. **Description of project:** The Project would allow for the development and operation of three (3) rail loop tracks totaling approximately 33,000 track feet, a rail ladder track totaling approximately 25,000 track feet, and approximately 2,000 track feet of spur that all tie into the adjacent Union Pacific Railroad ROW ('rail system'). The rail system will facilitate inbound and outbound trains of commodities as well as the transloading of commodities to and from trucks. Also included in the Project are a grain elevator; shipping container depot, including but not limited to the function of hay/grain export; a veterans memorial area adjacent to the existing cemetery; a fuel blending / transloading area; a fueling station, including but not limited to Compressed Natural Gas (CNG, methane); the extension of a SoCal Gas line from Keystone Road approximately 1.3 miles along State Route 86 to the Project Site; warehousing; and areas for transloading and storage of commodities (Proposed Project). Further, the Project's Tentative Tract Map proposes to re-configure the existing parcels and a grant of road right-of-way to the County for an Industrial Street. The Project also includes a specific plan amendment and zone change application to change land use and zoning from Light and Medium Industrial to Heavy Industrial.
11. **Surrounding land uses and setting:** Mesquite Lake Specific Plan is located north, east, and south of the Project site, with agricultural land uses and equipment dealerships and other businesses located west of the Project site. North of the site is vacant, disturbed land, followed by a sugar manufacturing facility. East of the site is the UPRR, followed by agricultural fields. South of the site are agricultural fields as well as a property with a CUP for the development of a fertilizer terminal. The constructed portion of the fertilizer terminal is 3-phase power located in the center of the parcel, which tenant farmers farm. A mix of agricultural fields and manufacturing uses, including Bakersfield Pipe Supply, RDO Farm Equipment, Empire Construction Machine Rental, and Rain for Rent, are located west of the Project site. The nearest single-family home is located approximately 0.25 mile east of the Project site.
12. **Other public agencies whose approval is required** (e.g., permits, financing approval, or participation agreement): Imperial Irrigation District (IID), Imperial County Air Pollution Control District (ICAPCD), California Department of Transportation (CalTrans), California State Water Resources Control Board (SWRCB), California Department of Fish and Wildlife (CDFW), U.S. Army Corps of Engineers (USACE), U.S. Fish and Wildlife Service (USFWS), Native American Heritage Commission (NAHC), California Environmental Protection Agency (CalEPA).
13. **Have California Native American tribes traditionally and culturally affiliated with the project area requested consultation pursuant to Public Resources Code section 21080.3.1? If so, has consultation begun?**

In accordance with Senate Bill (SB) 18 and Assembly Bill (AB) 52, Native American tribes with potential resources in the area were notified of the Project on August 29, 2022, with a late SB 18 letter being sent out on October 18, 2022

---

and offered the opportunity for consultation. Responses for SB 18 were due by November 28, 2022 and January 16, 2023 respectively, and AB 52 responses were due by September 28, 2022. As of January 17, 2023, the Quechan Tribe of the Fort Yuma Reservation was the only Tribe to respond, noting that they have no comments on the Project.

**Note: Conducting consultation early in the CEQA process allows tribal governments, lead agencies, and project proponents to discuss the level of environmental review, identify and address potential adverse impacts to tribal cultural resources, and reduce the potential for delay and conflict in the environmental review process. (See Public Resources Code, Section 21083.3.2). Information may also be available from the California Native American Heritage Commission's Sacred Lands File per Public Resources Code, Section 5097.96 and the California Historical Resources Information System administered by the California Office of Historic Preservation. Please also note that Public Resources Code, Section 21082.3 (c) contains provisions specific to confidentiality.**



**ENVIRONMENTAL FACTORS POTENTIALLY AFFECTED:**

The environmental factors checked below would be potentially affected by this project, involving at least one impact that is a "Potentially Significant Impact" as indicated by the checklist on the following pages.

- |  |   |   |
|--|---|---|
| <input type="checkbox"/> Aesthetics                | <input type="checkbox"/> Agriculture and Forestry Resources | <input type="checkbox"/> Air Quality                        |
| <input type="checkbox"/> Biological Resources      | <input type="checkbox"/> Cultural Resources                 | <input type="checkbox"/> Energy                             |
| <input type="checkbox"/> Geology /Soils            | <input type="checkbox"/> Greenhouse Gas Emissions           | <input type="checkbox"/> Hazards & Hazardous Materials      |
| <input type="checkbox"/> Hydrology / Water Quality | <input type="checkbox"/> Land Use / Planning                | <input type="checkbox"/> Mineral Resources                  |
| <input type="checkbox"/> Noise                     | <input type="checkbox"/> Population / Housing               | <input type="checkbox"/> Public Services                    |
| <input type="checkbox"/> Recreation                | <input type="checkbox"/> Transportation                     | <input type="checkbox"/> Tribal Cultural Resources          |
| <input type="checkbox"/> Utilities/Service Systems | <input type="checkbox"/> Wildfire                           | <input type="checkbox"/> Mandatory Findings of Significance |

**ENVIRONMENTAL EVALUATION COMMITTEE (EEC) DETERMINATION**

After Review of the Initial Study, the Environmental Evaluation Committee has:

Found that the proposed project COULD NOT have a significant effect on the environment, and a NEGATIVE DECLARATION will be prepared.

Found that although the proposed project could have a significant effect on the environment, there will not be a significant effect in this case because revisions in the project have been made by or agreed to by the project proponent. A MITIGATED NEGATIVE DECLARATION will be prepared.

Found that the proposed project MAY have a significant effect on the environment, and an ENVIRONMENTAL IMPACT REPORT is required.

Found that the proposed project MAY have a "potentially significant impact" or "potentially significant unless mitigated" impact on the environment, but at least one effect 1) has been adequately analyzed in an earlier document pursuant to applicable legal standards and 2) has been addressed by mitigation measures based on the earlier analysis as described on attached sheets. An ENVIRONMENTAL IMPACT REPORT is required, but it must analyze only the effects that remain to be addressed.

Found that although the proposed project could have a significant effect on the environment, because all potentially significant effects (a) have been analyzed adequately in an earlier EIR or NEGATIVE DECLARATION pursuant to applicable standards and (b) have been avoided or mitigated pursuant to that earlier EIR or NEGATIVE DECLARATION, including revisions or mitigation measures that are imposed upon the proposed project, nothing further is required.

CALIFORNIA DEPARTMENT OF FISH AND WILDLIFE DE MINIMIS IMPACT FINDING:  Yes  No

<u>EEC VOTES</u>	<u>YES</u>	<u>NO</u>	<u>ABSENT</u>
PUBLIC WORKS	<input checked="" type="checkbox"/>	<input type="checkbox"/>	<input type="checkbox"/>
ENVIRONMENTAL HEALTH SVCS	<input checked="" type="checkbox"/>	<input type="checkbox"/>	<input type="checkbox"/>
OFFICE EMERGENCY SERVICES	<input checked="" type="checkbox"/>	<input type="checkbox"/>	<input type="checkbox"/>
APCD	<input checked="" type="checkbox"/>	<input type="checkbox"/>	<input type="checkbox"/>
AG	<input checked="" type="checkbox"/>	<input type="checkbox"/>	<input type="checkbox"/>
SHERIFF DEPARTMENT	<input checked="" type="checkbox"/>	<input type="checkbox"/>	<input type="checkbox"/>
ICPDS	<input checked="" type="checkbox"/>	<input type="checkbox"/>	<input type="checkbox"/>

*for Mike Minnick*  
 \_\_\_\_\_  
 Jim Minnick, Director of Planning/EEC Chairman

*8-10-2023*  
 Date:

---

## **PROJECT SUMMARY**

---

Tomcat Development LLC (Applicant) is proposing the Green Valley Logistics Center Project (Project or Proposed Project), a Railroad Facility on approximately 285 acres in Imperial County (County), California. The Project would allow for the development and operation of three (3) rail loop tracks totaling approximately 22,000 track feet, a rail ladder track totaling approximately 25,000 track feet, and approximately 2,000 track feet of spur that all tie into the adjacent Union Pacific Railroad right-of-way (ROW; 'rail system'). The Railroad Facility will facilitate inbound and outbound trains of commodities as well as the transloading of commodities to and from trucks. Near the tracks will be a warehousing building(s) and covered storage area(s). Also included in the Project are a grain elevator; shipping container depot, including, but not limited to, the function of hay/grain export; a veteran's memorial area adjacent to the existing cemetery; a fuel blending / transloading area, a fueling station, including, but not limited to CNG (compressed natural gas), unleaded fuel, electrical vehicle chargers, hydrogen fueling and diesel. The extension of SoCal Gas's main line will be extended approximately 1.3 miles along State Route 86 to the Project site from Keystone Road to the north; and areas for transloading and storage of commodities (Proposed Project). Further, the Project's Tentative Tract Map proposes to re-configure the existing parcels and grant of road right-of way to the County for an Industrial Street. After the County approves the Tentative Tract Map, a Final Map will need to be recorded to effectuate the proposed property lines and dedicate the road ROW to the County. The Project also includes a specific plan amendment and zone change application to change land use and zoning for a portion of the site from Light and Medium Industrial to Heavy Industrial for land use, and Mesquite Lake Governmental / Special Public and Mesquite Lake Medium Industrial to Mesquite Lake Heavy Industrial for zoning.

### **A. PROJECT LOCATION**

The Project is located on approximately 285 gross acres within Imperial County, California, approximately 1.25 miles north of the City of Imperial (Project site; Figure 1, Project Site Location). The Project is west of the Union Pacific Railroad (UPRR), east of SR 86 (Imperial Avenue), north of Harris Road, and south of Newside Drain Number 1-A. The Project is entirely within the Mesquite Lake Specific Plan on land owned by Tomcat Development LLC. The Project is within Section 31 of Township 14 South, Range 14 East, San Bernardino Base Meridian on APNs 040-340-004, 040-340-006, 040-340-032 and 040-340-033.

The Project area is zoned Mesquite Lake Specific Plan, including ML GS (Mesquite Lake Government / Special Public), ML I-2 (Mesquite Lake Medium Industrial) and ML I-3 (Mesquite Lake Heavy Industrial), with a Renewable Energy Overlay Zone (Figure 2, Zoning Map). The General Plan Land Use designation for the entire Project is Mesquite Lake Specific Plan (Figure 3, Land Use Designation Map).

### **B. CURRENT USE OF THE PROJECT SITE, SURROUNDING AREAS, AND EXISTING CONDITIONS**

The Project site contains existing agricultural operations, including approximately 120 acres of recently harvested wheat that is planted and harvested as a rotation crop between other crops as well as approximately 84 acres that has been periodically farmed and is currently growing sugar beets and sudan grass. The Project has an existing mainline switch on the Union Pacific Railroad and approximately 0.5 mile of on-site track. The Project site has vacant areas that have previously been farmed and the existing Memory Gardens Cemetery. Over the last 10 years, the Project site has consumed approximately 630 acre-feet per year (AFY) of water for agricultural purposes based on an average use factor of 5.25 acre-feet per acre. Based on delivery records from IID from 2013 thru 2022 the Project site has historically used an annual average of 1,708 AFY for agricultural and landscaping purposes.

Mesquite Lake Specific Plan is located north, east, and south of the Project site, with agricultural land uses and equipment dealerships and other businesses located west of the Project site. North of the site is vacant, disturbed land, followed by a sugar manufacturing facility. East of the site is the UPRR, followed by agricultural fields. South of the site are agricultural fields as well as a property with a CUP for the development of a fertilizer terminal. A mix of agricultural fields and manufacturing uses, including Bakersfield Pipe Supply, RDO Farm Equipment, Empire Construction Machine Rental, and Rain for Rent, are located west of the Project site. The nearest single-family home is located approximately 0.25 mile east of the Project site.

---

As previously mentioned, this document incorporates by reference the Mesquite Lake Specific Plan and Mesquite Lake Specific Plan EIR (SCH# 2005021116), both prepared by the County of Imperial in 2006. The Mesquite Lake Specific Plan consists of approximately 5,100 acres located in central Imperial County, between State Route (SR) 86 on the west and SR 111 plus ¼ mile on the east and is bordered by Harris Road on the south and Keystone Road on the north. Imperial County designated the Mesquite Lake Specific Plan Area on the 1993 General Plan to provide an opportunity to develop new job-producing light, medium, and heavy industrial uses. The County for evaluation in the Mesquite Lake Specific Plan Master Environmental Impact Report (MEIR) identified the following specific environmental issues:

- Agricultural Resources
- Hydrology and Water Quality
- Air Quality and Odor
- Land Use and Planning
- Biological Resources
- Archaeological Resources
- Hazards and Hazardous Materials
- Aesthetics and Visual Resources
- Public Services and Utilities
- Traffic/Circulation

Impacts to Mineral Resources, Noise, Population and Housing, and Recreation were evaluated under the effects found not to be significant section of the MEIR. No resource areas that are evaluated per the 2022 Appendix G CEQA Guidelines, were required to be evaluated at the time 2006.

The overall goal of the Mesquite Lake Specific Plan is to support economic development within Imperial County and allow for heavy industrial development in an area that is away from urban conflicts and its cities through job creation in the employment sectors of manufacturing, fabrication, processing, wholesaling, transportation, and energy resource development; and, create and preserve an area where a full range of industrial uses with moderate to high nuisance characteristics may locate.

Figure 1: Project Site Location

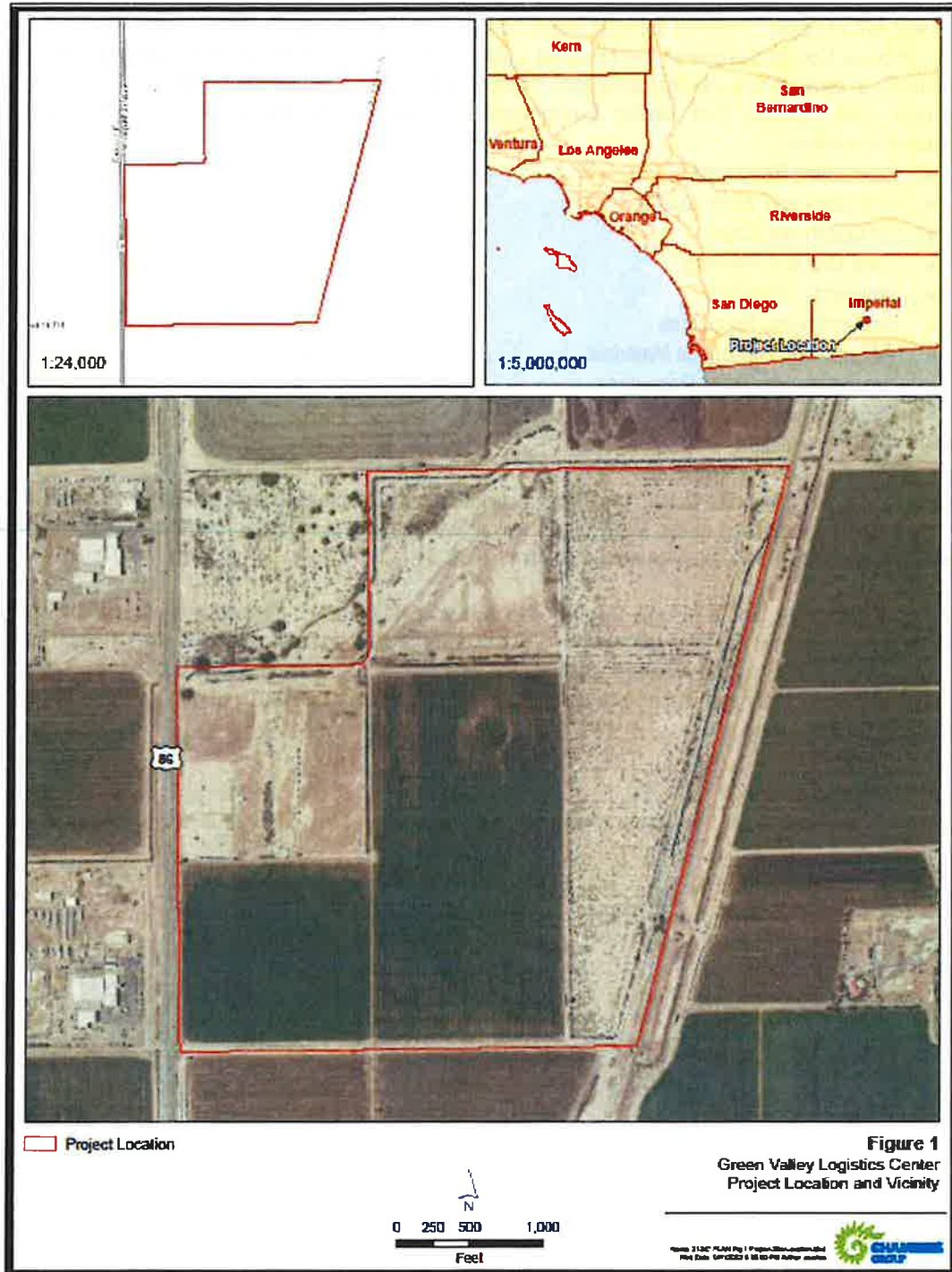



Figure 2: Zoning Map

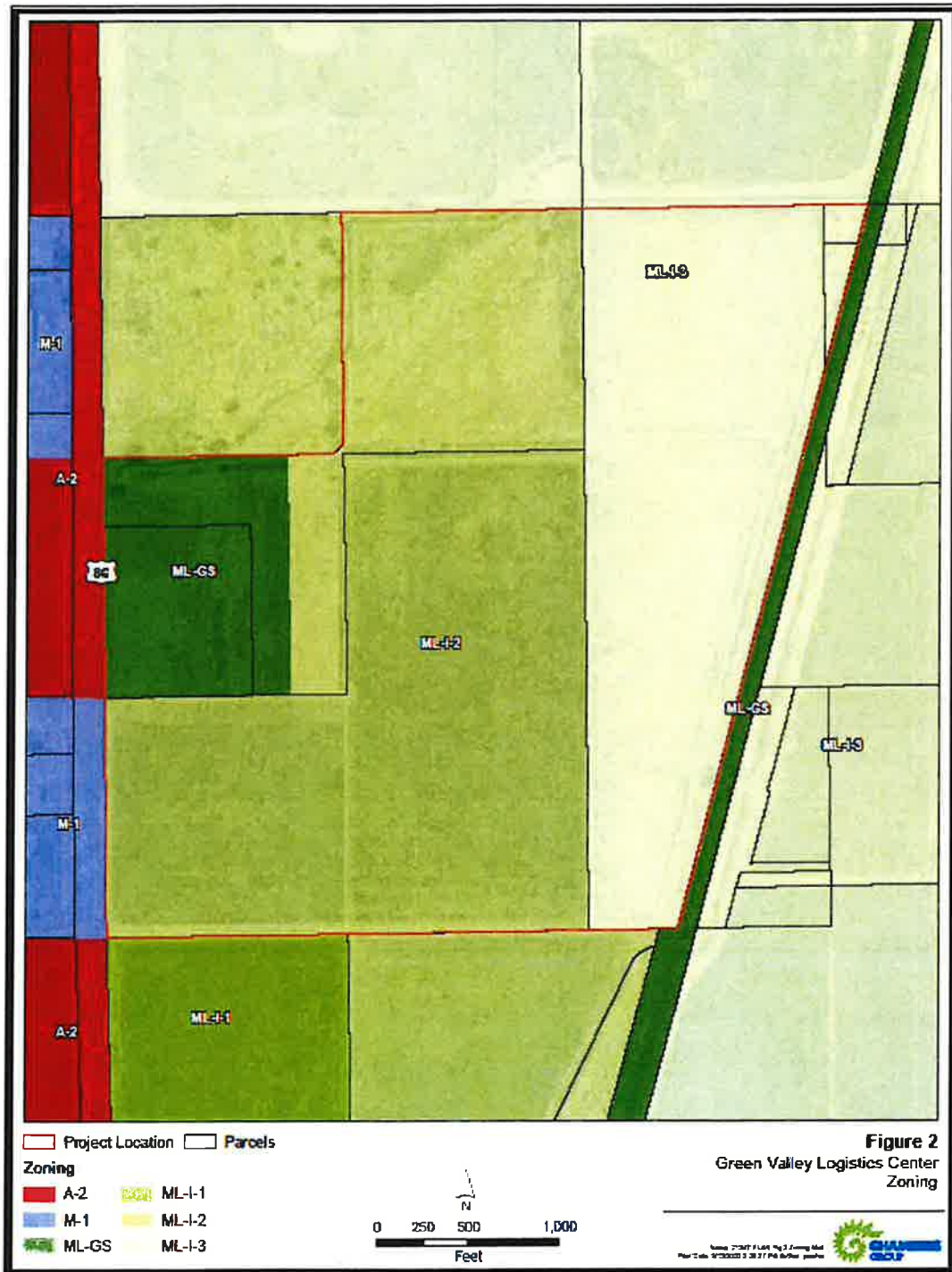
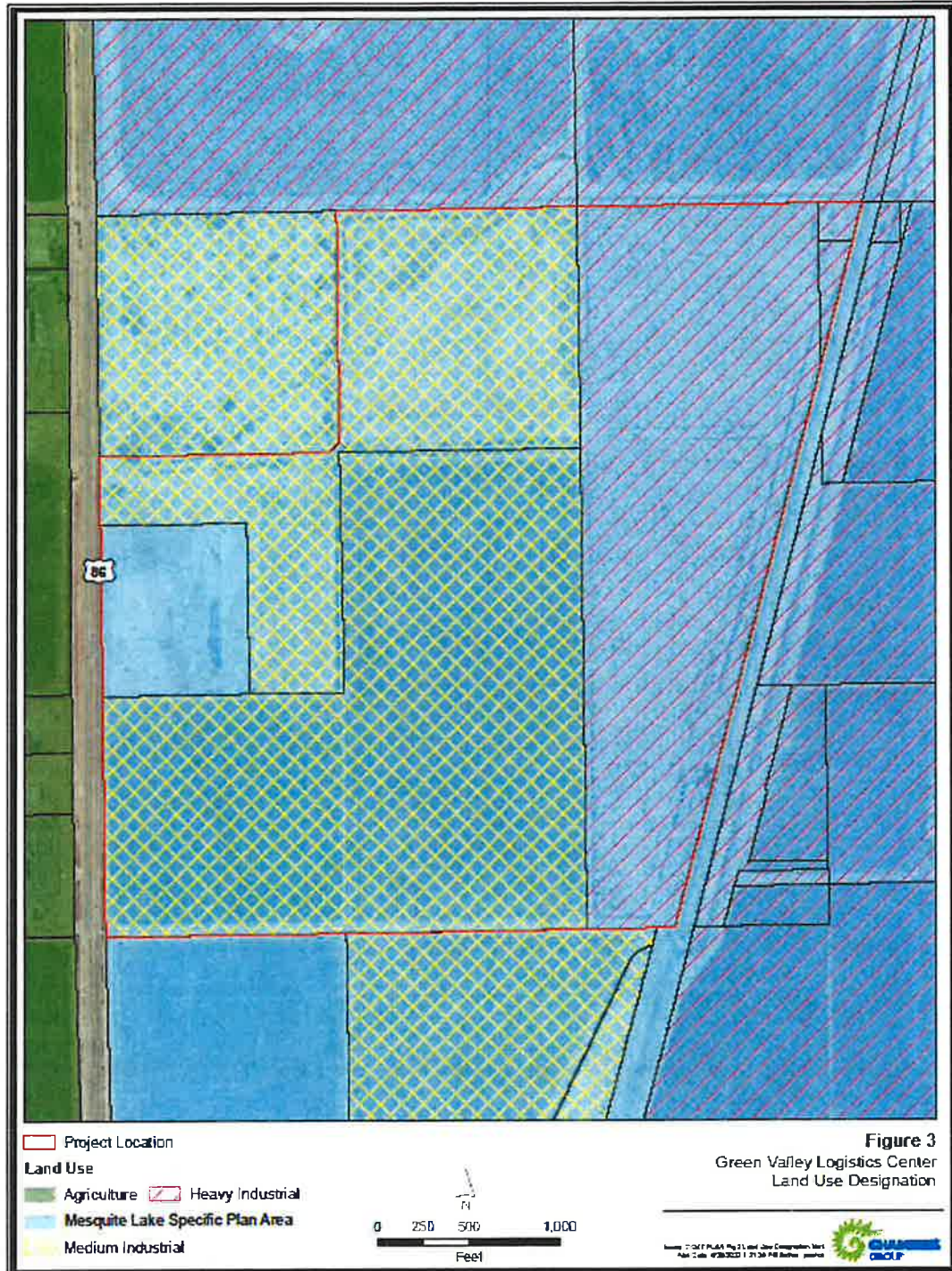

Figure 3: Land Use Designation Map





## C. PROJECT SUMMARY

The Project would include the uses as described in Table 1: Proposed Uses.

**Table 1: Proposed Uses**

Use	Logistical Function / Description	Approximate Area (acres)
Existing Cemetery and Memorial Area	Regular Vehicle Traffic	10
Grain Elevator System	Inbound Rail – Outbound Truck for Corn/Grain Distribution to Cattle Feeder Yards	10
Centralized Water Treatment & Storage System	Provide Potable & Fire Water to the Project Area	2
Hay and Grain Export and Container Depot	Hay/Grain: Inbound Truck – Outbound Rail Containers: Inbound Rail – Outbound Rail and Truck	144
Produce / Food Export Transloading/Warehousing	Inbound Truck – Outbound Rail	10
Fuel Blending / Transloading	Inbound Rail – Outbound Truck	10
Fueling Station, including but not Limited to CNG	Trucks Already On-Site Fuel Up and Public Use	9.5
General Commodities: Transloading/Warehousing	Inbound Rail – Outbound Truck	64
Storm Water Retention Basin	Project Hydrology Program	19
Circulation	On-site Project Roadway	6
<b>Total</b>		<b>284.5</b>

As mentioned in Table 1, the Project includes development of a stormwater retention basin. The Project site layout is illustrated in Figure 4, Project Site Plan. The Project's Tentative Tract Map proposes to re-configure the existing parcels, and grant of road right-of-way to the County for an Industrial Street. Site uses are further described in Project Operations below.

As mentioned, the Project also includes a specific plan amendment and a zone change to amend parcels, approximately 195 acres, from ML-GS and ML I-2 to ML I-3 and from Light and Medium Industrial to Heavy Industrial, as shown in Figure 5, Proposed Land Use and Zoning Changes. The Heavy Industrial designation would allow for greater flexibility in terms of industrial uses. The proposed zoning and lot line adjustments are shown in Figure 6, Proposed Zoning, Land Use, and Lot Lines. The allowed uses for each zone are described below and in Table 2: Allowed Uses.

### **ML GS (Mesquite Lake Government/Special Public)**

The ML GS (Mesquite Lake Government/Special Public) zoning designation may be applied within the Specific Plan to allow for the construction, development, and operation of governmental facilities and special public facilities, as permitted in the G/S (Government/Special Public) Zone of the County Land Use Ordinance but excluding jails or other incarceration facilities.

**THE HOLT GROUP, INC.**  
 REGISTERED PROFESSIONAL ENGINEER  
 1501 N. IMPERIAL AVE.  
 SUITE 200  
 BRAMLEY, CA 92227  
 TEL: (760) 554-3091

PROJECT BENCH MARK:  
 THE HOLT GROUP, INC. (1997)  
 1501 N. IMPERIAL AVE., SUITE 200, BRAMLEY, CA 92227  
 THE HOLT GROUP, INC. (1997)

APPROVED DATE: \_\_\_\_\_  
 APPROVED DATE: \_\_\_\_\_

DATE: 1/26/2023  
 REC. DOR: 15/01/2023  
 JAMES D. YACOVOLAKI, P.E.  
 31773

PREPARED UNDER THE DIRECT SUPERVISION OF: \_\_\_\_\_  
 IN THE COUNTY OF IMPERIAL, STATE OF CALIFORNIA  
 TRACT MAP NO. 00993  
 19 OF 2 SHEETS  
 1729.001

**LEGAL DESCRIPTION**

APN 616-340-030-000 & 040-340-033-000  
 PARCEL 1:  
 TRACT 88, TOWNSHIP 14 SOUTH, RANGE 14 EAST, S.B.M. IN AN UNINCORPORATED AREA OF THE COUNTY OF IMPERIAL, STATE OF CALIFORNIA, ACCORDING TO THE OFFICIAL PLAT THEREOF.  
 EXCEPTING THEREFROM THE SOUTH 640 FEET OF THE WEST 330 FEET THEREOF.  
 ALSO EXCEPTING THEREFROM THAT PORTION LYING WITHIN STATE HWY 86  
 ALSO EXCEPTING THEREFROM THE FOLLOWING DESCRIBED PARCEL:  
 BEGINNING AT THE INTERSECTION OF THE EAST LINE OF HIGHWAY 89 WITH THE NORTH LINE OF TRACT 86; THENCE SOUTH 75 FEET, TO A POINT 15 FEET EAST OF THE POINT OF BEGINNING; THENCE WEST 75 FEET TO SAID POINT OF BEGINNING, AS CONVEYED TO APN 616-340-030-000 & 040-340-033-000 BY INSTRUMENT NO. 88 OF OFFICIAL RECORDS, SEPTEMBER 22, 1984 AS INSTRUMENT NO. 88 OF OFFICIAL RECORDS.

**APPLICANT/DEVELOPER**

APN 616-340-030-000 & 040-340-033-000  
 PARCEL 1:  
 TRACT 88, TOWNSHIP 14 SOUTH, RANGE 14 EAST, S.B.M. IN AN UNINCORPORATED AREA OF THE COUNTY OF IMPERIAL, STATE OF CALIFORNIA, ACCORDING TO THE OFFICIAL PLAT THEREOF.  
 EXCEPTING THEREFROM THE SOUTH 640 FEET OF THE WEST 330 FEET THEREOF.  
 ALSO EXCEPTING THEREFROM THAT PORTION LYING WITHIN STATE HWY 86  
 ALSO EXCEPTING THEREFROM THE FOLLOWING DESCRIBED PARCEL:  
 BEGINNING AT THE INTERSECTION OF THE EAST LINE OF HIGHWAY 89 WITH THE NORTH LINE OF TRACT 86; THENCE SOUTH 75 FEET, TO A POINT 15 FEET EAST OF THE POINT OF BEGINNING; THENCE WEST 75 FEET TO SAID POINT OF BEGINNING, AS CONVEYED TO APN 616-340-030-000 & 040-340-033-000 BY INSTRUMENT NO. 88 OF OFFICIAL RECORDS, SEPTEMBER 22, 1984 AS INSTRUMENT NO. 88 OF OFFICIAL RECORDS.

**ENGINEER**

THE HOLT GROUP  
 1501 N. IMPERIAL AVE.  
 SUITE 200  
 BRAMLEY, CA 92227  
 TEL: (760) 554-3091

**ZONING**

ML C-3 (MEASURE LAKE GOVERNMENT/SPECIAL PUBLIC)  
 ML C-2 (MEASURE LAKE MEDIUM INDUSTRIAL)  
 ML I-3 (MEASURE LAKE HEAVY INDUSTRIAL)

**FLOOD ZONE**

ALSO REFERENCED TO BE DETERMINE THE 1% ANNUAL FLOOD FLOODPLAIN FOR FIRM NUMBER 60255S-0375C, EFFECTIVE DATE SEPTEMBER 26, 2008.

**BASIS OF BEARING**

THE BASIS OF BEARING IS DEFINED AS THE BEARING BETWEEN COYNE STATION "SPRINKLERLESS2005" AND COYNE STATION "SPRINKLERLESS2005" AND STATION "SPRINKLERLESS2005" AND GAS HORIZONTAL CONTROL STATION "J 1225" HORIZONTAL CONTROL STATION "J 1223".  
 SPRINKLERLESS2005 FILE NO. 00000000000000000000  
 STATIONING: 677029.33'  
 J 1225: 605.000, 6000.118  
 STATIONING: 192143.64'  
 NORTHING: 677928.65'  
 EASTING: 677928.65'

**UTILITIES**

SAN WATER FROM LATERAL 8  
 AS SHOWN ON THE PLAT  
 SEWER: 24" DIA.  
 WATER: 8" DIA. (CONCRETE) CONCERNING OF BUT NOT LIMITED TO THE FOLLOWING: LOTS 2 & 3, AND (B) NORTHERLY SHOULDER OF HARRIS ROAD

**SUBDIVIDER'S STATEMENT**

I, THE ENGINEER, HEREBY CERTIFY THAT THE INFORMATION CONTAINED HEREIN IS TRUE AND CORRECT TO THE BEST OF MY KNOWLEDGE AND BELIEF.

**VICINITY MAP**

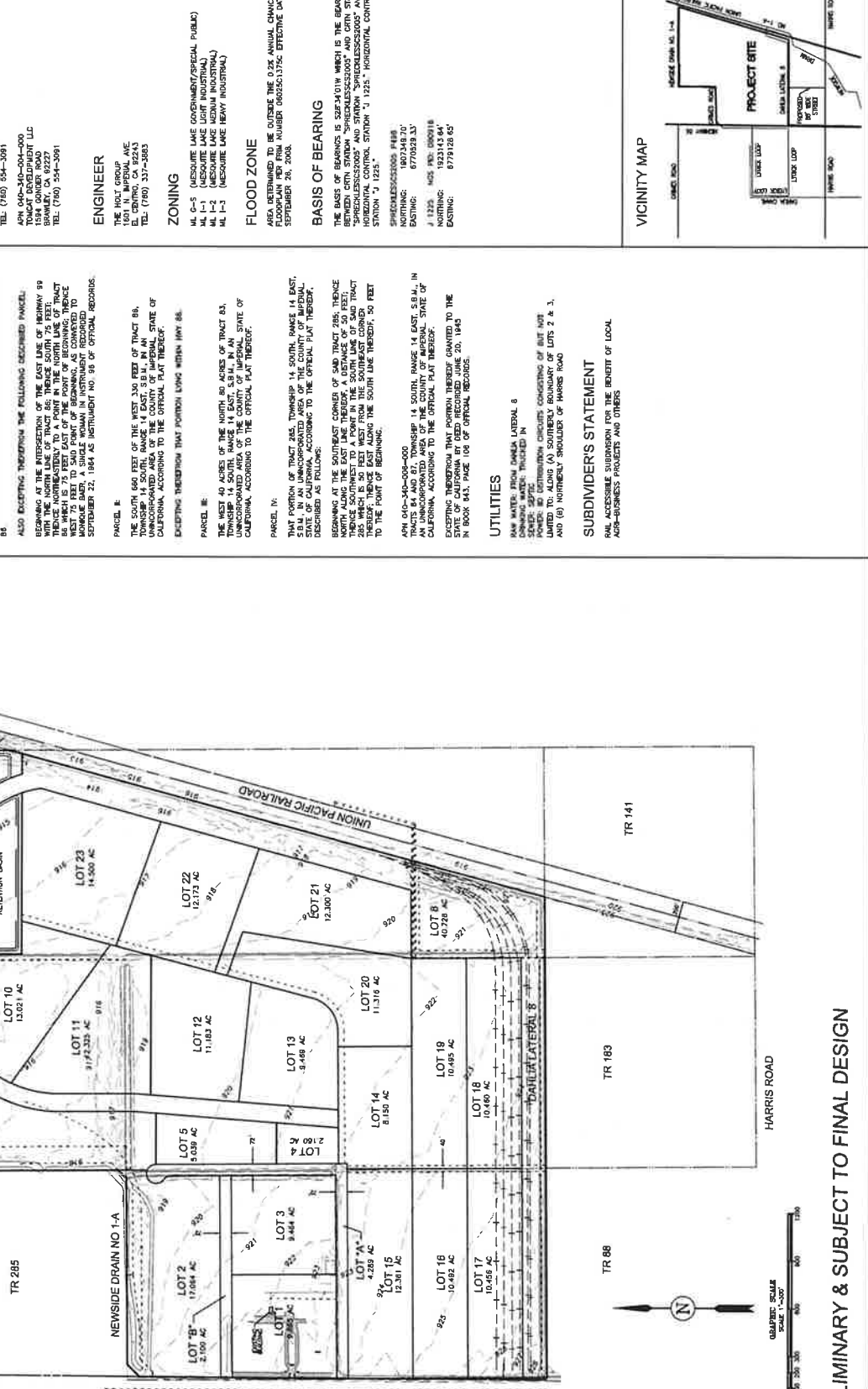

PRELIMINARY & SUBJECT TO FINAL DESIGN  
 EEC ORIGINAL PKG





**ML I-2: Medium Industrial**

The MLI-2 (Mesquite Lake Medium Industrial) zoning designation is intended to provide areas to accommodate light (MLI-1) and medium intensity industrial type uses such as wholesale distribution centers, warehousing, storage, trucking, assembly type manufacturing, general manufacturing, research and development, medium intensity fabrication, and other similar medium intensity processing facilities, industrial/business parks, industrial plants, power plants (generation and transmission of electrical energy), truck and rail container storage, and research and development facilities. The processing or fabrication within any of these facilities is to be limited to activities conducted either entirely within a building or within securely fenced (obscured fencing) areas. Provided further that such facilities do not omit fumes, odor, dust, smoke, or gas beyond the confines of the property line within which their activity occurs or produces significant levels of noise or vibration beyond the perimeter of the site. Certain specified agricultural and agricultural processing uses would also be permitted.

**ML I-3 Allowed Uses**

The MLI-3 zoning designation is for most intense, heaviest type of manufacturing processing, or fabrication facilities. It will however also allow "permitted" uses from the MLI-1 and MLI-2 type of uses, provided they are compatible and meet the standards of the plan. Processing or fabrication in these areas is allowed to be conducted entirely within a building or outside of a building, provided however the facility does not omit fumes, odors, dust, smoke, or gas beyond the confines of the property upon which the activity occurs, nor produces significant levels of noise or vibrations beyond the perimeter of the site. Certain specified agricultural uses would also be permitted.

**Table 2: Allowed Uses**

Use	Zoning		
	ML GS	ML I-2	ML I-3
Airport (public).	A	-	-
Adult care facilities.	-	-	-
Agricultural products (growing, harvesting, and processing).	A	-	-
Business and industry incubation space (non-volatile materials).	A	-	-
Cargo container (provided they have an approved building permit).	A	-	-
Childcare facilities.	-	-	-
Commercial cannabis (cultivation non-volatile materials), subject to Division 4, Chapter 6 of Title 9, Land Use Ordinance and Title 14 of the Imperial County Codified Ordinances.	A	-	-
County buildings.	A	-	-
Electrical vehicles charging stations as an accessory use (incidental to primary use).	A	-	-
Incarceration.	-	-	-
Industrial hemp, including the cultivation, harvesting and testing, and light processing, subject to Division 4, Chapter 6 of Title 9, Land Use Ordinance and Title 14 of the Imperial County Codified Ordinances.	A	-	-
Industrial hemp (non-volatile materials): Manufacturing into semi-finished and finished products, subject to Division 4, Chapter 6 of Title 9 Land Use Ordinance and Title 14 of the Imperial County Codified Ordinances.	A	-	-
Maintenance facilities.	A	-	-
Offices.	A	-	-
Parks, organized camps.	A	-	-
Public buildings.	A	-	-
Research and development (non-volatile materials).	A	-	-
Schools.	A	-	-
Solar energy extraction generation if it is for on-site consumption only.	A	-	-
Solid waste recycling facility.	A	-	-
Airport (private)	CUP	-	-
Business and industry incubation space (volatile materials).	CUP	-	-

Use	Zoning		
	ML GS	ML I-2	ML I-3
Commercial cannabis manufacturing (volatile materials), subject to Division 4, Chapter 6 of Title 9, Land Use Ordinance and Title 14 of the Imperial County Codified Ordinances.	CUP	-	-
Communication towers, including radio, television, cellular, digital, along with the necessary support equipment such as receivers, transmitters, antennas, satellite dishes, relays, etc. (subject to requirements of this zone and Division 24; Section 92401 "Communications Facilities Ordinance" et al).	CUP	-	-
Hazardous materials disposal	CUP	-	-
Hazardous materials processing	CUP	-	-
Hazardous materials recycling	CUP	-	-
Hazardous materials treating	CUP	-	-
Industrial hemp (volatile materials): manufacturing into semi-finished and finished products, subject to Division 4, Chapter 6 of Title 9, Land Use Ordinance and Title 14 of the Imperial County Codified Ordinance	CUP	-	-
Major facilities relating to the generation and transmission of electrical energy provides such facilities are not under state or federal law, to approve exclusively by an agency, or agencies of the state or federal government, and provided such facilities shall be approved subsequent to coordination review of the IID for electrical matters. Such uses shall include but be limited to the following: Electrical generation plants (less than 50 WW). Facilities for the transmission of electrical energy (100—200 kV). Electrical substations in an electrical transmission system (500 kV/230 kV/161 kV)	CUP	-	-
Research and development (volatile materials)	CUP	-	-
Solid waste landfill facility	CUP	-	-
Training facility	CUP	-	-
Water treatment facility	CUP	-	-
Wastewater treatment facility	CUP	-	-
Caretaker or security residence	A	A	A
Retail Trade	-	A	A
Agricultural/Nursery Supplies and Services	-	A	A
Automotive and Light Truck Repair	-	A	A
Building Contractor's Offices and Yards	-	A	A
Services and Related Support Facilities	-	A	A
Administrative and Professional Offices	-	A	A
Conference/Convention/Meeting Facilities	-	A	A
Repair and Rental Services	-	A	A
Manufacturing and Assembly	-	A	A
Light Manufacturing	-	A	A
Medium Manufacturing	-	A	A
Heavy Manufacturing	-	-	A
Wholesale, Storage, and Distribution	-	A	A
Light/Medium Wholesale, Storage, and Distribution Activities	-	A	A
Heavy Wholesale, Storage and Distribution	-	CUP	A
Agricultural Crops and Processing (growing and harvesting agricultural crops)	-	A	A
Agricultural Processing (packing and processing excluding animal products or byproducts)	-	CUP	A
Agricultural Crops and Processing (growing and harvesting including fish and frog farms or other agricultural packing and processing for products sold for human consumption)	-	-	A
Agricultural Processing (packing and processing including products or byproducts)	-	-	CUP
Public, Semi-Public, and Institutional Uses	-	A	A
(i) Post Office	-	A	A
(ii) Law Enforcement/Life Safety Facilities	-	A	A



Use	Zoning		
	ML GS	ML I-2	ML I-3
(iii) Water treatment plants	-	A	A
(iv) Sewage treatment plants	-	A	A
(v) Flood Control Facilities (other than on-site detention)	-	A	A
Similar Uses Permitted by Planning Commission Determination	-	A	A
Generation and Transmission of Electrical Power	-	CUP	A
Manufacturing and Assembly	-	CUP	A
Minimum Impact Heavy Manufacturing	-	CUP	A
Wholesale, Storage and Distribution	-	CUP	A
Transportation Facilities	-	CUP	A
(a) Heliports/helistops	-	CUP	A
(b) Railroads spurs and yards	-	CUP	A
Communication and Public Utilities	-	CUP	A
Recycling Facilities	-	CUP	CUP
Alternative Fuel Power Generating Facilities	-	-	CUP
Tire/Rubber Rendering Plan	-	-	CUP

**Notes:**

A = Allowed

CUP = Allowed with Conditional Use Permit

- = Not Allowed Use

Specific Allowed Uses:

**Light Manufacturing:**

Activities typically include, but are not limited to, labor-intensive manufacturing, assembly, fabrication, or repair processes that do not involve large container truck traffic or the transport of large-scale bulky products but may include limited rail traffic. The new product may be finished in the sense that it is ready for use or consumption, or it may be semi-finished, meaning it would become a component for further assembly and packaging. These types of business establishments are customarily directed to the wholesale market or inter-plant transfer rather than the direct sale to the consumer. Such uses may include, but are not limited to: electronic microchip assembly; printing, publishing and allied industries; candy and other confectionery products; bottled or canned soft drinks and carbonated waters; apparel and other finished products; paper board containers and boxes; drugs; small fabricated metal products such as hand tools, general hardware, architectural and ornamental metal work; and toys, amusements, sports, and athletic goods. The activities do not produce odors, noise, vibration, hazardous waste material or particulates that would adversely affect other uses in the structure or on the same site. Where 24-hour on-site surveillance is necessary, a caretaker's residence may be permitted when approved by a CUP.

**Medium Manufacturing:**

Activities typically include, but are not limited to, manufacturing, compounding of materials, processing, assembly, packaging, treatment or fabrication of materials and products that require frequent large container truck traffic or rail traffic, or the transport of heavy, bulky items. The new products are semi-finished to be a component for further manufacturing, fabrication, and assembly. These types of business establishments are customarily directed to inter-plant transfer, or to order from industrial uses, rather than for direct sale to the domestic consumer. Such uses may include, but are not limited to, activities involving the following products: frozen foods; canned food; fresh agricultural products; textile products; furniture and fixtures; converted paper and paper board products; plastic products made from purchased rubber, plastic, or resin; graphite, gypsum, and fabricated metal products made from sheet metals; electrical and electronic machinery, equipment and supplies; and office, computing, and accounting machines. Activities may produce noise, odors, vibrations, illumination, or particulates that affect the persons residing in or conducting business in the vicinity. Where 24-hour on-site surveillance is necessary, a caretaker's residence may be permitted when approved by a CUP.

**Heavy Manufacturing:**

Activities typically include, but are not limited to, manufacturing, compounding of material, processing, assembly, packaging, treatment, or fabrication, and activities that may have frequent rail or truck traffic or the transportation of heavy large-scale products. Activities in this area may generate noise, odor, vibration, illumination, or particulates which may be obnoxious or offensive to persons residing or conducting business in the vicinity. Uses typically use raw materials such as wood, metal, glass, composites, plastic, rubber, gelatin, or aggregate materials (e.g., gypsum, sand, rock, granite, concrete) to fabricate

---

semi-finished products that include, but are not limited to, forge shops, metal fabricating facilities, open welding shops, lumber woodworking facilities, heavy machine shops, chemical storage and distribution, plastics plants, and light or vacuum casting facilities.

Manufacturing uses allowed in the MLI-3 Land Use Designation include the following:

- (i) All manufacturing uses allowed in the MLI-2 Land Use Designation.
- (ii) Acid manufacturing, ammunition manufacturing, asbestos manufacturing plant, creosote manufacturing, curing, tanning and storage of raw hides or skins, distillation of bones, distillation of coal, wood or tar, drop forge industries, explosive manufacturing and storage, fat rendering, gas manufacturing, graphite manufacturing, iron, steel, brass or copper foundries or fabrication plants, rubber and rubber products manufacturing, automobile assembly plants (body and fender works).
- (iii) Smelting of tin, copper, zinc or iron ore, ore reduction plants, quarry, or stone mills, rolling mills, lumber mills.
- (iv) Petroleum refineries, incinerators, coke ovens.

### **Development Standards**

All new construction and future use of land within the Mesquite Lake Specific Plan must be in accordance with the Development Standards specified in Section IV of the Specific Plan. Where the provisions of Section IV differ from specified development standards or regulations in the County Land Use Ordinance, the provisions in the Specific Plan take precedence. Where Section IV of the Specific Plan does not address a particular use, standard, or regulation specified in the County Land Use Ordinance, the provisions of the Land Use Ordinance apply.

### **D. PROJECT CONSTRUCTION:**

Construction of the Project is expected to begin in approximately 2024 and would continue for an estimated 18 months if the site is built-out under a single construction effort. Site preparation is anticipated to take approximately 2 months, grading to take approximately 2 months, and vertical construction to occur over approximately 14 months. The Project is expected to employ approximately 400 construction workers over the course of build-out, with as many as 200 workers on-site daily during construction once structures and buildings go vertical. The Project is expected to use approximately 1,000 AFY of water during construction. Project build-out is expected to occur in approximately 2026. Construction activities of the Proposed Project will be scheduled in compliance with the Mesquite Lake Specific Plan and County's Municipal Code Title 9 for the provisions of operating and permitting the use of tools and equipment during construction, drilling, repair, or alterations. Project construction may occur incrementally overtime as a function of the need for incremental access to rail and other site infrastructure, and accordingly building permits may be issued incrementally over time.

Site preparation will include clearing and grubbing. The land development includes grading the site to create a rough graded street, native soil preparatory work for track facilities, and pads for new construction. The site preparation will include an estimated 150,000 cubic yards of cut and 150,000 cubic yards of fill; soil will be balanced on site. Other material imports would include an import of approximately 140,000 cubic yards of granular select fill for use underneath concrete building pads, an import of approximately 225,000 tons of ballast and 90,000 tons of sub-ballast for the three (3) loop tracks (approximately 22,000 track feet in total), ladder track (approximately 25,000 track feet in total) and rail spur (approximately 2,000 track feet in total), and 28,000 tons of road base for the Industrial Street roadway, which will be surface finished with asphalt concrete. Other on-site flatwork will be finished with asphalt concrete and Portland cement concrete, including building and structural pads, which will be comprised of rebar and Portland cement concrete. A concrete and rebar bridge/over-pass or a culvert/under-pass may ultimately be built in order to take trucks to and from the middle of the Project once full loop tracks are built. Prior to the full loop tracks being constructed, a private roadway will be constructed for access to the central part of the Project.

In order for the aforementioned ladder track to be built approximately 400' of the IID Dahlia Lateral 8 Canal will need to be pipelined near the SE corner of the Project Site. Encroachment Permit drawings will be prepared and submitted to the IID for the pipelining and proposed ladder tracks. A detail showing the approximate limits of the canal pipelining is provided as follows:

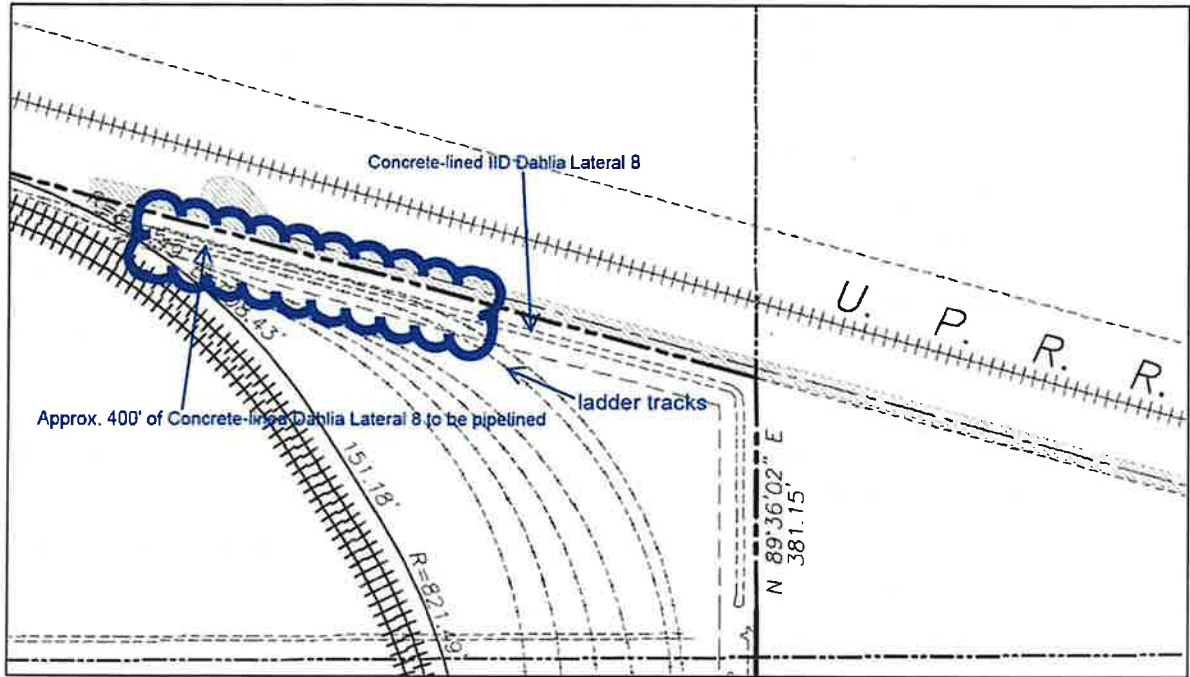

In addition to contractor vehicles, heavy equipment will be used on site and will include, but is not limited to, excavators, backhoes, trenchers, cranes, bulldozers, graders, compactors, track laying equipment, pavers, and dump trucks. All equipment will be staged within the Project site. Access to the UPRR Right-of-Way (ROW) and The County ROW will be needed for construction.

## E. PROJECT OPERATIONS

Routine operations and maintenance of the facility will include preventative maintenance and repairs of any damaged or otherwise inoperable equipment on an as-needed basis. The operation and maintenance staff will monitor the facility operations over the Project life to ensure that the logistics center is operating to meet design standards. Approximately 56 full-time employees are expected each day of the week during Project operations to cover the below shown elements of the Project, with approximately 2 shifts per day (5am to 1pm and 11am to 7pm). The below shown Project elements will be developed in accordance with Mesquite Lake Specific Plan and County development standards.

### Existing Cemetery and Memorial Area

The existing Memory Gardens Cemetery is part of the subject property and has existing water and electrical service from the Imperial Irrigation District. The property lines around the existing 7-acre cemetery are being adjusted for inclusion of a memorial area in honor of veterans east of and adjacent to the cemetery and the new cemetery overall area will be approximately 10 acres in total. The cemetery and memorial area will be fenced-off from the remaining portion of the Project area with either chain link and privacy slats, wood, or vinyl fencing. Access to the cemetery (and memorial area) will be via the cemetery's existing and historical access from SR 86. Improvements at the memorial area would consist of landscaping and lighting consistent with Mesquite Lake Specific Plan and County Planning & Development Services requirements. This portion of the cemetery will include memorial improvements, restrooms, and landscaped walkways and will contain a septic system and leach field in accordance with State and County standards. Water service would be provided from the overall Project's centralized water treatment and distribution system. Raw water for landscaping is currently provided from the IID Dahlia Lateral 8 and such serviced will be continued in the future for irrigation purposes. Volunteers currently maintain the cemetery and will continue to do so in the future, likely under the ownership and management of a newly formed non-profit entity. The existing cemetery has approximately 20 vehicles coming on-site per day and an Average Daily Traffic (ADT) of 40 and no increase in traffic is expected to



---

occur.

### **Grain Elevator System**

The grain elevator is primarily for receiving corn and similar grain products via rail and distributing them to cattle feeding yards. The grain elevator system will be up to 180 feet tall and be comprised of up to four (4) large tanks/bins initially, expanding to a total of eight (8) large tanks/bins, and several ancillary mechanical components and will be built on a parcel that is approximately 10 acres. The grain elevator would receive approximately 450,000 tons (40-unit trains) of corn annually and approximately 150,000 tons (20 trains) of Dried Distillers Grain (DDG) annually via the proposed loop tracks or via other on-site tracks. This portion of the Project would employ approximately eight people split between approximately two shifts per day (5am to 1pm and 11am to 7pm). UPRR unit trains of corn are currently 110 rail cars in length; however, the rail industry is moving to expand unit rail length to approximately 126 cars. The DDG would come into the site via approximately 75-car trains and may come in via the loop tracks or via the ladder tracks south of and adjacent to, the loop tracks. Grain such as corn and DDG may also be brought to the site by Union Pacific in smaller blocks such as 30 to 50 rail cars. Ancillary improvements beyond the actual grain elevator system will be consistent with the Mesquite Lake Specific Plan and County Planning & Development Services requirements, including development of office area, landscaping, and lighting. This portion of the Project would also include restrooms, hardscaped walkways, and hydrants for fire suppression. This portion of the Project would contain a septic system and leach field in accordance with State and County standards and water for the restrooms, firewater and water for operations would be provided from the overall project's centralized water treatment and distribution system or as otherwise approved by the County.

### **Centralized Water Treatment, Storage & Distribution System**

The Project will include a water treatment, storage and distribution system that will satisfy potable water and firewater requirements. The system will receive water from the IID Dahlia Lateral 8 canal located along the southerly boundary of the Project. The treatment, storage and pump elements of the system will be located on the approximately 2-acres of the Project area. The distribution element of the system will be a looped pressurized water line that will provide access to water for all Project parcels. The water treatment, storage and distribution system will likely be developed in phases with an initial phase having a storage capacity of approximately 180,000 gallons and a built-out storage capacity of up to 1.5 million gallons. A 1.5 million gallon tank would be approximately 50 feet tall and approximately 100 feet in diameter. During initial operations and prior to the need for a public water system, the applicant may truck-in purified/potable water.

### **Hay and Grain Export and Container Depot**

The area in the middle of the loop tracks will be used primarily as a shipping container depot and for exporting hay and grain products via UPRR. The hay and grain export and container depot would employ approximately 12 people split between approximately two shifts per day (5am to 1pm and 11am to 7pm). Hay and grain trucks each carrying approximately twenty-five (25) containerized tons would be required per day to bring inbound hay and grain to the facility where it would be railed to the Ports of Los Angeles and Long Beach. The hay and grain would be grown within the irrigated area of Imperial County and brought to the site intermittently during hours of operation. Ocean shipping containers would arrive on-site via UPRR from the Ports of Los Angeles and Long Beach full of miscellaneous products from overseas that are destined for distribution throughout the United States and Mexico. The miscellaneous products from overseas would be sorted and placed into domestic shipping containers for out-bound shipment via UPRR to major metropolitan hubs throughout the United States. In addition, full containers of miscellaneous products from the Ports of Los Angeles and Long Beach would arrive on-site via UPRR and be transloaded to truck for delivery to Mexico. The ocean shipping containers stuffed with hay and grain would be exported from the site via UPRR and returned to the ports of Los Angeles and Long Beach for shipment overseas to pre-dominantly Asian and Middle Eastern markets. This area will also intermittently receive empty containers from coastal and inland ports for storage and shipping reuse and may be used for the rail served transloading and warehousing of general commodities.

Ancillary improvements beyond the actual hay and grain export and container depot system will be consistent with Mesquite Lake Specific Plan and County Planning & Development Services requirements and include parking, an office

---

area, landscaping, and lighting. This portion of the Project would also include restrooms, hardscaped walkways, and a hydrant for fire suppression. This portion of the Project would contain a septic system and leach field in accordance with State and County standards and water for the restrooms, fire water and water for operations would be provided from the overall project's centralized water treatment and distribution system.

### Produce / Food Export

The produce export function would employ approximately six people split between approximately two shifts per day (5am to 1pm and 11am to 7pm). Produce would be trucked in on-site from locally grown sources, may be temperature treated (cold storage prior to customer shipment), and would be exported via UPRR to domestic and international customers. Such produces would likely consist of the following: (a) Broccoli: 45,000 tons, (b) Cabbage: 26,000 tons, (c) Carrot: 128,000 tons, (d) Cauliflower: 77,000 tons, (e) Cantaloupe: 120,000 tons, (f) Citrus: 2,000 tons, (g) Onion: 110,000 tons, and (h) beef: 42,000 tons.

Produce and food grown outside of the County would be railed into the County via UPRR, sorted, stored and shipped to Mexico via truck. Such produce and food would likely consist of the following: (a) Apples, Onions and Potatoes: 35,000 tons, (b) Dry food goods : 20,000 tons, (c) Palletized food products packaged in cans : 25,000 tons, (d) Frozen pork : 145,000 tons, (e) Frozen poultry : 160,000 tons, and (f) Processed food grain corn in super sacks : 20,000 tons.

Ancillary improvements beyond the actual product export system include parking, office area, landscaping, and lighting consistent with Mesquite Lake Specific Plan and County Planning & Development Services requirements. This portion of the Project would also include restrooms, hardscaped walkways, and hydrants for fire suppression. This portion of the Project would contain a septic system and leach field in accordance with State and County standards and water for the restrooms, firewater and water for operations would be provided from the overall project's centralized water treatment and distribution system.

### Fuel Blending / Transloading

Fuel products will be railed in on-site and transloaded/blended for outbound movement via truck to off-site locations, including Mexico. The approximate amount of fuel that will be annually transloaded/blended at the Project are as follows: (a) Biodiesel fuel: 130,000,000 gallons, (b) Regular diesel: 50,000,000 gallons, and (c) Liquefied Petroleum Gas (LPG)/Natural Gas Liquids (NGL): 90,000,000 gallons. The fuel blending / transloading function would employ approximately four people split between approximately two shifts per day (5am to 1pm and 11am to 7pm). The facility would have the ability to store up to 2,000,000 gallons of fuel on-site via up to four (4) above ground tanks.

Ancillary improvements beyond the actual fuel blending / transloading system include, but are not limited to, parking, office area, landscaping, and lighting consistent with Mesquite Lake Specific Plan and County Planning & Development Services requirements. This portion of the Project would also include restrooms, hardscaped walkways, and hydrant(s) for fire suppression. This portion of the Project would contain a septic system and leach field in accordance with State and County standards and water for the restrooms, firewater and water for operations would be provided from the overall project's centralized water treatment and distribution system.

### Fueling Station Including CNG

The fueling station would be used to fuel vehicles and trucks on site. The approximate amount of fuel sold from the fueling station on an annual basis is as follows: (a) Unleaded fuel: 2,500,000 gallons, (b) Diesel: 4,750,000 gallons, (c) CNG: 5,500,000 gallons. Electric vehicles and hydrogen fuel cell vehicles will also be able to fill up at the fueling station. There would also be truck scales on-site at the fueling station and throughout the rest of the Project site as well as an approximately 30,000 square foot travel center area. The SoCal Gas pipeline that is being extended to the Project site approximately 1.3 miles along State Route 86 from Keystone Road would supply gas to the CNG fueling component of the fueling station.

Ancillary improvements beyond the actual fueling station system include, but are not limited to, landscaping and lighting consistent with Mesquite Lake Specific Plan and County Planning & Development Services requirements, hardscaped walkways, and hydrant(s) for fire suppression. This portion of the Project would contain a septic system and leach field



---

in accordance with State and County standards and water for the restrooms, firewater and water for operations would be provided from the overall project's centralized water treatment and distribution system.

#### **General Commodities: Transloading/Warehousing**

The remaining portion of the Project area that is not occupied by the above-mentioned Project elements will be used for the transloading, storage and shipment of additional commodities. The approximate types and amounts of general commodities being transloaded/warehoused on an annual basis on site is as follows: (a) Lumber: 150,000 tons, (b) Fertilizers: 30,000 tons, (c) Plastics: 60,000 tons, (d) Rolled Steel: 85,000 tons, (e) 35% Hydrochloric Acid: 60,000 tons, (f) 50% Caustic Soda: 40,000 tons, (g) 95% Sulfuric Acid: 25,000 tons and (h) Paper: 50,000 tons. Transloading/warehousing of general commodities would employ approximately 18 people split between approximately two shifts per day (5am to 1pm and 11am to 7pm).

Ancillary improvements beyond the transloading/warehousing system(s) include, but are not limited to, parking, office area, landscaping, and lighting consistent with Mesquite Lake Specific Plan and County Planning & Development Services requirements. This portion of the Project would also include restrooms, hardscaped walkways, and tanks for fire suppression. This portion of the Project would contain a septic system and leach field in accordance with State and County standards and filtration treated raw water for the restrooms and raw water service from IID for operations, along with trucked in drinking water.

#### **Parking and Site Access**

The Project area's only existing access is from State Route 86 and the Project proposes continued access from State Route 86 via 2 driveways – a right in and a right out. The cemetery and memorial area will be accessed via its existing historical SR 86 access or via a frontage road located between the 2 new State Route 86 access points. All individual elements of the logistics center will each have their own quantity of dedicated parking spots consistent with the Signs, Parking and Fences section of the Mesquite Lake Specific Plan. After all related approvals are complete and prior to building permit issuance, the applicant will submit final site plan with proposed parking to County Planning & Development Services for review and approval.

#### **Stormwater**

The entire Project site would drain into a stormwater retention basin located on the northern portion of the Project site that is approximately 19 acres.

This Project retention basin will connect and drain into the IID Newside Drain Number 1-A after upgrading the site's historical connection to said IID drain. The upgrade typically consists of the installation of a storm drain manhole with a one-way flapper valve along the existing pipe that conveys storm water/tail water from the drop box inlet on the adjacent private property to the point of outflow within the IID drain. Said manhole is typically located outside of the IID drain right-of-way and an upstream segment of new pipe is typically connected to said manhole along with a new inlet installed at the low point of the retention basin. An example of a typical construction detail is shown below. Encroachment Permit drawings will be prepared and submitted to IID for the drain connection. The retention basin will be designed to meet SWRCB requirements and will include an appropriate mosquito abatement per County guidelines if the retention basin does fully discharge in less than 72 hours.

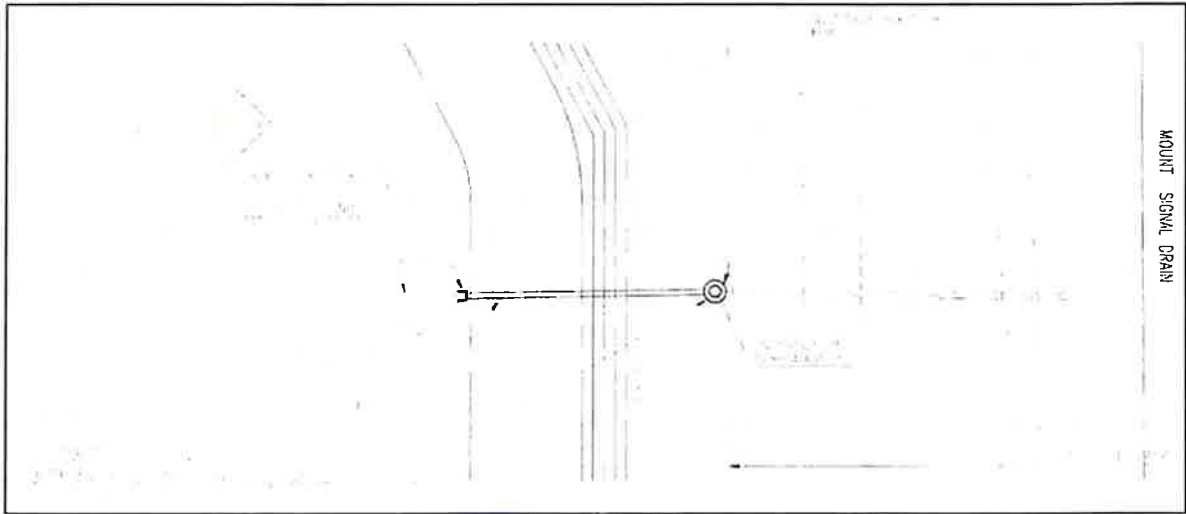

**Proposed Trip Generation** The following is a trip generation table for the Project: **Utilities**

The Proposed Project will receive raw water from IID via the Dahlia Lateral 8 and treat said raw water to potable standards for distribution to all Project elements, which will procure their own respective quantities of water. Conversely, if potable treatment and distribution throughout the Project is cost prohibitive, individual users of the Project may address potable water by other means e.g., truck in potable water, individual user treatment facilities, etc. The Project will also have its own dedicated raw water line for access to bulk process water from IID.

Over the last 10 years, the Project site has consumed approximately 630 acre-feet of water per year on average in order for 120 acres of the Project site to be farmed based on an average use factor of 5.25 acre-feet per acre per year (AFY). Based on delivery records from IID from 2013 thru 2022 the Project site has historically used an annual average of 1,708 AFY for agricultural and landscaping purposes. The proposed annual water usage, including operational water and drinking water for the Project site once fully developed is shown in the following **Table 3: Proposed Water Use**.

**Table 3: Proposed Water Use**

Use	Acre-Feet Per Year (AFY)
<b>Existing</b>	
Agricultural Operations	630
<i>Total</i>	<i>630</i>
<b>Proposed</b>	
Existing Cemetery and Memorial Area	50
Grain Elevator System	20
Hay and Grain Export and Container Depot	30
Produce / Food Export	25
Fuel Blending / Transloading	15
Fueling Station including CNG	10
General Commodities: Transloading/Warehouse	30
<i>Total</i>	<i>180</i>
<b>Net Decrease</b>	<b>450</b>

The Project will include septic systems with leach fields for the different elements of the logistics center in accordance with State and County standards. Electrical service will be from IID existing on-site distribution level voltage facilities near the cemetery, the existing IID on-site distribution level voltage facilities near the UPRR, IID existing distribution

---

level voltage facilities south of the site along Harris Road, and/or self-generated with solar panels. If solar panels are used, they would be installed on the roofs of buildings and would interconnect by way of a bi-directional meter that would also serve as the metering element for power purchased from IID. The solar panels would be used solely for Project operations. The solar panels could utilize a battery energy storage element that would require approval from the County Planning Department, prior to installation.

Natural gas will come from the SoCal Gas existing pipeline system on Keystone Road. IID also has transmission level voltage facilities east of the site along the UPRR ROW, which can be tapped as needed for substation development. The applicant will develop the necessary off-site improvements that are required to bring natural gas service to the Project site. The Project will contract with third party utility companies for other utilities like telecom, internet and solid waste pick up services.

### **Fire Protection and Safety**

Water for fire protection would be purchased from IID and stored in ponds and/or above ground storage tanks in accordance with County Fire Department standards. The system will be designed in accordance with federal, state, and local fire codes, occupational health and safety regulations and other jurisdictional codes, requirements, and standard practices.

### **Hazardous Materials and Waste**

The Project will develop and implement a Hazardous Materials Business Plan (HMBP), in compliance with California Health and Safety Code, Division 20, Chapter 6.95, Sections 25500-25519 and California Code of Regulations, Title 19, Division 2, Chapter 4. The HMBP will be provided to the California Office of Emergency Services, the County Fire Department, and the Certified Unified Program Agency for the County (the local California Department of Toxic Substances Control office), for review and approval before plant operation. The HMBP will include, at a minimum, procedures for:

- Hazardous materials handling, use and storage
- Emergency response
- Spill control and prevention
- Employee training
- Reporting and record keeping

Portable bins or other storage containers will be on site for storage of maintenance lube oils, chemicals, paints, and other construction materials, as needed. Hazardous materials that are expected to be used during construction will include:

- Unleaded gasoline
- Diesel fuel
- Oil
- Hydraulic fluids
- Lubricants
- Solvents
- Adhesives
- Paint material

Hazardous materials that are expected to be used during operation will include:

- Unleaded gasoline
- Diesel fuel
- Transformer Oil
- Hydraulic fluid

Hazardous material carriers and hazardous waste transporters are required by law to adhere to applicable local, State, and federal regulations regarding proper truck signage, indicating the materials being transported, carrying a

---

shipping/waste manifest of the types and concentrations of materials being transported, and other appropriate measures. Hazardous material carriers also are responsible for their loads, reporting spills, and initiating appropriate emergency response to releases of any transported hazardous materials, from the point of origin up to the destination of the hazardous material delivery.

---

## F. PROJECT DECOMMISSIONING AND ABANDONMENT

The projected life of the Project is approximately 50 years. At the end of operations, a Site Abandonment Plan will be prepared and implemented in conformance with The County and CUPA requirements, for consideration by the Planning Commission prior to Project approval. The Plan will describe the proposed equipment dismantling and site restoration program in conformance with the wishes of the respective landowners/lessors and requirements in effect at the time of abandonment and would be implemented at the end of Project operations.

## H. REQUIRED PERMITS AND APPROVALS

### Lead Agency Approval

Imperial County Planning Department is the lead agency for the Proposed Project. The following permits would be required from the lead agency:

- Imperial County Planning Department – Zone Change for ML GS and ML I-2 to ML I-3
- Imperial County Planning Department – Mesquite Lake Specific Plan Amendment from Light Industrial and Medium Industrial to Heavy Industrial
- Imperial County Planning Department – Tentative Tract Map (including grant of road ROW to the County for 72-foot-wide Industrial Street)
- Imperial County Planning Department – Variance for structures over 80 feet tall
- Imperial County Planning Department – Development Agreement (if required)
- Imperial County Planning Department – Occupancy Permits

### Reviewing Agencies

#### State Agencies:

- Certified Unified Program Agencies (CUPA) – Underground Storage Tank (UST) Permit
- Caltrans – Encroachment Permit
- CDFW – Lake or Streambed Alteration Agreement and ITP
- California Department of Toxic Substances/CUPA – Hazardous Materials / Environmental Protection Agency Approvals and Permits
- Union Pacific Railroad – Encroachment Permit(s), Industry Track Agreement(s), and Joint-use Agreement(s)

#### Regional Agencies:

- Regional Water Quality Control Board – Waste Discharge Requirement and 401 Water Quality Certification
- IID – Water Supply Assessment, Electrical Service Permitting, Encroachment Permit(s) and Water Supply Agreement(s)
- ICAPCD – Permit to Construct and Permit to Operate
- Imperial County Building Department – Building and Grading Permits
- Imperial County Public Works Department – Encroachment Permit(s) and Improvement Plans
- Imperial County Fire Department and Office of Emergency Services – Emergency Access and Fire Prevention and Suppression Systems, California Accidental Release Prevention (CalARP) Program
- Imperial County Environmental Health Services – water treatment permitting and septic system permitting and Hazardous Materials Business Plan
- Joint Agencies: Local Enforcement Agency, CalRecycle and Regional Water Quality Control Board – Solid Waste Facility Permit

---

## I. OBJECTIVES

The Project objectives include the following:

- Develop a logistics center with an emphasis on agri-business uses that is also capable of servicing other commodities/sectors.
- Develop a rail system for the unloading of up to unit train volumes of corn-filled rail cars from the UPRR.
- To support the Imperial County Mesquite Lake Specific Plan policies and objectives:
  - Develop new industrial land uses
  - Focus on job-producing uses
  - Diversifying employment opportunities
  - In addition to direct job creation, encourage and promote local economic growth and secondary employment opportunities at off-site locations such as in commercial services and construction employment sectors
  - Increase local tax base, which will enable improvement to community services and construction of new public buildings and facilities
- To locate the Project at a location along the existing Union Pacific Railroad ROW in a land use and zoning designation where it is feasible to import, transload, store and export commodities.
- To meet the terms and requirements of any Industry Track Agreement (ITA) that the Applicant has or may enter into and that require Applicant to have access to the Union Pacific Railroad main line from land with supporting land use and zoning characteristics.
- To operate a logistics center efficiently and at a cost that is competitive in the supply-chain marketplace on real property controlled by the Applicant.
- To expand/enhance trade with Mexico and national and international markets for the opportunity to diversify the County's employment base.
- To provide an additional source of supply chain services to assist the region, state, and nation in decongesting roads, freeways, and ports.
- To assist the State of California and United States in their environmental policies and objectives to reduce greenhouse gas emissions by reducing the number of miles products and commodities must be trucked to get from origin to destination.
- To maximize local construction jobs for a variety of trades thereby helping maximize the reduction of unemployment in the construction sector.
- To locate the Project in an area that has historically been identified and zoned for industrial development and job creation.
- To diversify the County's economic base.
- To provide tax revenue through sales, use and property taxes generated by development within the Mesquite Lake Specific Plan.

### EVALUATION OF ENVIRONMENTAL IMPACTS:

- 1) A brief explanation is required for all answers except "No Impact" answers that are adequately supported by the information sources a lead agency cites in the parentheses following each question. A "No Impact" answer is adequately supported if the referenced information sources show that the impact simply does not apply to projects like the one involved (e.g., the project falls outside a fault rupture zone). A "No Impact" answer should be explained where it is based on project-specific factors as well as general standards (e.g., the project will not expose sensitive receptors to pollutants, based on a project-specific screening analysis).
- 2) All answers must take account of the whole action involved, including off-site as well as on-site, cumulative as well as project-level, indirect as well as direct, and construction as well as operational impacts.
- 3) Once the lead agency has determined that a particular physical impact may occur, then the checklist answers must indicate whether the impact is potentially significant, less than significant with mitigation, or less than significant. "Potentially Significant Impact" is appropriate if there is substantial evidence that an effect may be



- 
- significant. If there are one or more "Potentially Significant Impact" entries when the determination is made, an EIR is required.
- 4) "Negative Declaration: Less Than Significant With Mitigation Incorporated" applies where the incorporation of mitigation measures has reduced an effect from "Potentially Significant Impact" to a "Less Than Significant Impact." The lead agency must describe the mitigation measures, and briefly explain how they reduce the effect to a less than significant level (mitigation measures from "Earlier Analyses," as described in (5) below, may be cross-referenced).
  - 5) Earlier analyses may be used where, pursuant to the tiering, program EIR, or other CEQA process, an effect has been adequately analyzed in an earlier EIR or negative declaration. Section 15063(c)(3)(D). In this case, a brief discussion should identify the following:
    - a) Earlier Analysis Used. Identify and state where they are available for review.
    - b) Impacts Adequately Addressed. Identify which effects from the above checklist were within the scope of and adequately analyzed in an earlier document pursuant to applicable legal standards, and state whether such effects were addressed by mitigation measures based on the earlier analysis.
    - c) Mitigation Measures. For effects that are "Less than Significant with Mitigation Measures Incorporated," describe the mitigation measures, which were incorporated or refined from the earlier document and the extent to which they address site-specific conditions for the project.
  - 6) Lead agencies are encouraged to incorporate into the checklist references to information sources for potential impacts (e.g., general plans, zoning ordinances). Reference to a previously prepared or outside document should, where appropriate, include a reference to the page or pages where the statement is substantiated.
  - 7) Supporting Information Sources: A source list should be attached, and other sources used or individuals contacted should be cited in the discussion.
  - 8) This is only a suggested form, and lead agencies are free to use different formats; however, lead agencies should normally address the questions from this checklist that are relevant to a project's environmental effects in whatever format is selected.
  - 9) The explanation of each issue should identify:
    - a) the significance criteria or threshold, if any, used to evaluate each question; and
    - b) the mitigation measure identified, if any, to reduce the impact to less than significance

Potentially Significant Impact (PSI)	Less Than Significant with Mitigation Incorporated (LTSWMI)	Less Than Significant Impact (LTSI)	No Impact (NI)
--------------------------------------	---	-------------------------------------	----------------

**I. AESTHETICS**

Except as provided in Public Resources Code Section 21099, would the project:

- |  |                          |                          |                                     |                          |
|--|--------------------------|--------------------------|-------------------------------------|--------------------------|
| a) Have a substantial adverse effect on a scenic vista or scenic highway?  | <input type="checkbox"/> | <input type="checkbox"/> | <input checked="" type="checkbox"/> | <input type="checkbox"/> |
| b) Substantially damage scenic resources, including, but not limited to trees, rock outcroppings, and historic buildings within a state scenic highway?  | <input type="checkbox"/> | <input type="checkbox"/> | <input checked="" type="checkbox"/> | <input type="checkbox"/> |
| c) In non-urbanized areas, substantially degrade the existing visual character or quality of public views of the site and its surrounding? (Public views are those that are experienced from publicly accessible vantage point.) If the project is in an urbanized area, would the project conflict with applicable zoning and other regulations governing scenic quality? | <input type="checkbox"/> | <input type="checkbox"/> | <input checked="" type="checkbox"/> | <input type="checkbox"/> |
| d) Create a new source of substantial light or glare which would adversely affect day or nighttime views in the area?  | <input type="checkbox"/> | <input type="checkbox"/> | <input checked="" type="checkbox"/> | <input type="checkbox"/> |

**Summary of Impacts Identified in the MEIR:**

The MEIR included an analysis of the aesthetic and visual resources within the specific plan area. Among other development standards, the MEIR evaluated a maximum height of six stories or 80 feet. At the time the MEIR was approved, most of the specific plan area was covered with farmland or farm-related auxiliary structures with minimal ornamental vegetation. Most of the trees were associated with the cemetery. Given the flat topography of the specific plan area, there are no surrounding elevated views possible. The view shed included surrounding farmlands and segments of State Route (SR) 86, SR 111, Keystone Road, Dogwood Road, and Harris Road.

The MEIR found that the Mesquite Lake specific plan area was not located within a scenic vista or near a scenic highway. It determined that, due to the aesthetics of the area, no sensitive viewers would be impacted by development occurring within the specific plan area. Given that the area was on a former flat lakebed with little topographic relief, any grading required during development would not result in significant landform alteration. Construction at the undeveloped areas (or proposed redevelopment) would be introducing utilitarian structures that would be comparable to the existing facilities, in addition to complying with the development standards within the specific plan area. While future development within the specific plan area would intensify the number of structures and scale of the built environment, the majority of the viewers (which would be motorists and workers) would have low visual quality expectations.

Construction related effects with the presence of equipment and stockpiles would have short-term, negative visual impacts. However, it was determined that these would be less than significant due to it being temporary, and that there are no sensitive vistas or viewers that would demand high visual quality in the area.

**Impacts Related to the Proposed Project:**

- |   |                          |                          |                                     |                          |
|---|--------------------------|--------------------------|-------------------------------------|--------------------------|
| a) Have a substantial adverse effect on a scenic vista or scenic highway? | <input type="checkbox"/> | <input type="checkbox"/> | <input checked="" type="checkbox"/> | <input type="checkbox"/> |
|---|--------------------------|--------------------------|-------------------------------------|--------------------------|

**a) Consistent with the MEIR, Less than Significant Impact.** The MEIR identified the Specific Plan not to be located on or within a scenic vista. According to the County's Conservation and Open Space Element, the Proposed Project and its immediate surroundings are not located within areas designated to have significant visual quality or scenic potential (County 2016a).

The General Plan EIR (County 1993a), notes that there were highways within the County that had potential to be considered as state-designated, or eligible scenic highways. These included Interstate (I) 8 (I-8), SR 78, SR 111 and the Borrego-Salton Seaway, also known as S-22. According to the California Department of Transportation (Caltrans) State Scenic Highway System Map (Caltrans 2018), these highways are part of the eligible and state-designated highways listings. However, these designated/potentially eligible routes are not located within the vicinity of the Proposed Project. The closest portion of Highway 111 that is eligible for listing is almost 33 miles north of the Project site.

The Project requires a variance request for any structures over 80 feet, which would include the grain elevator system that will be up to 180 feet tall and comprised of up to eight large tanks/bins. Due to this variance request for several structures, visual simulations were prepared for the proposed Project as shown in Figure 7 through Figure 10 below. In particular, Figure 10 shows a view of the Project as it would be seen from the direction of Highway 111. A very faint portion of the Project can be seen from this location, which is about 1.5 miles closer than Highway 111. Therefore, it is assumed that none of the Project site would be seen from Highway 111 at this location. While the Proposed Project may be viewed from various roadways by motorists such as those traveling along Dogwood Road, SR-86 and Harris Road, these areas are not designated as scenic, and views would be consistent with and typical of, industrial uses as shown in Figure 8. Additionally, only one single-family home is located approximately 0.25-mile east of the Project site. Figure 9 shows that views from this house would remain largely unchanged. Implementation of the Project would be consistent with the MEIR,



Potentially Significant Impact (PSI)	Less Than Significant With Mitigation Incorporated (LTSWMI)	Less Than Significant Impact (LTSI)	No Impact (NI)
--------------------------------------	---	-------------------------------------	----------------

and would not result in any new impacts that were not previously analyzed, and impacts would be less than significant.

- b) Substantially damage scenic resources, including, but not limited to trees, rock outcroppings, and historic buildings within a state scenic highway?

**b) Consistent with the MEIR, Less than Significant Impact.** As discussed in part a), the Proposed Project is not located within a state scenic or eligible scenic highway, nor is the Proposed Project nearby or within scenic vistas, or areas that may provide users with visual quality. The Project site contains existing agricultural operations, including approximately 120 acres of recently harvested wheat that is planted and harvested as a rotation crop between other crops. The Project has an existing mainline switch on the Union Pacific Railroad and approximately 0.5 mile of on-site track. The Project site has vacant areas that have previously been farmed and the existing Memory Gardens Cemetery. The Project site remains largely unchanged from the conditions described in the MEIR. Additionally, there are no rock outcroppings, or current historic buildings within the Proposed Project site. A couple trees exist on site, mostly surrounding the canals, several of which would remain on site. However, these trees do not define the visual characteristics of the site and removal of the limited number of trees as proposed does not substantially change or damage the visual character. Therefore, implementation of the Project would be consistent with the MEIR, and impacts would be less than significant.

- c) In non-urbanized areas, substantially degrade the existing visual character or quality of public views of the site and its surrounding? (Public views are those that are experienced from publicly accessible vantage point.) If the project is in an urbanized area, would the project conflict with applicable zoning and other regulations governing scenic quality?

**c) Consistent with the MEIR, Less than Significant Impact.** The MEIR conducted a Visual Resources Analysis discussing the potential visual impacts of development within the specific plan area. As discussed in part a) above, the MEIR and the County's General Plan Conservation Element identified that the Project site area does not have significant visual quality or scenic potential. The Project site would be defined as a mostly non-urbanized area. Visual simulations were prepared for the Proposed Project to display what visual changes from the existing conditions to the proposed conditions would occur, from various locations. Three viewpoints were selected to demonstrate the visual changes of the area as shown in Figure 7 through Figure 10. Based on the simulations, the Proposed Project is not seen to substantially degrade the existing visual character or quality of public views. As discussed in the MEIR, the specific plan area has been designated to be used for industrial and agricultural uses. The Proposed Project would be consistent with the uses as defined in the specific plan. Furthermore, the Proposed Project would be required to comply with the Development Standards of the Mesquite Lake Specific Plan to ensure the design would be consistent with existing and future development. Therefore, implementation of the Project would be consistent with the MEIR, and impacts would be less than significant.

- d) Create a new source of substantial light or glare which would adversely affect day or nighttime views in the area?

**d) Consistent with the MEIR, Less than Significant Impact.** Existing light and glare sources at the Proposed Project are from vehicles commuting along the roadways and from adjacent facilities including those along SR-86, Grimes Road, and Harris Road. Also existing directly west of the Project site is the Empire CAT Truck and Trailer store, the Rain for Rent store, RDO Equipment Company, and BPS Supply Group, and north of the site is Spreckels Sugar and SunHarvest Ag Services Inc., all of which would contain existing light and glare sources. During construction, sources of light and glare would come from the construction equipment being used and stored at the Project site. Once operational new light sources would come from the newly constructed buildings and from the presence of vehicles. Glare sources would come from any areas with reflective surfaces that includes building facades and windows. As discussed in the MEIR, construction effects would be temporary and short term and would be limited during the hours of 7:00 AM to 7:00 PM Monday through Friday, and 9:00 AM to 5:00 PM on Saturdays as per the County's General Plan Noise Element (County 2015a).

Potentially Significant Impact (PSI)	Less Than Significant With Mitigation Incorporated (LTSWMI)	Less Than Significant Impact (LTSI)	No Impact (NI)
--------------------------------------	---	-------------------------------------	----------------

Figure 10

Project operations would occur seven days per week, with approximately two shifts per day (5am to 1pm and 11am to 7pm). Minimal lighting would be required during these hours depending on the time of year, and little to no lighting would be required except for security, when the Project is not operating. Glare during operations could be seen from buildings and vehicles, however, the Proposed Project would be designed per the Development Standards of the Mesquite Lake Specific Plan which notes 'Exterior wall finishes should generally be concrete, masonry, or stucco, though metal or synthetic wall panels with a similar appearance to these materials may also be acceptable as determined by the Planning & Development Services Department.' Additionally, potential glare impacts could occur from solar panels, if utilized. However, if solar panels are used, they would be installed on the roofs of buildings, and would only be visible from above sources such as aircraft. However, as discussed in Section IX Hazards and Hazardous Materials, the nearest airport is over 6 miles southwest from the Project Site.

As described in the MEIR, the area does not propose development of residential spaces and the area is not compatible for residential uses. Furthermore, as mentioned, the Proposed Project would be designed per the Development Standards of the Mesquite Lake Specific Plan so that it would be consistent and compatible with existing and future development. Therefore, implementation of the Project would be consistent with the MEIR, and impacts would be less than significant.

**II. AGRICULTURE AND FOREST RESOURCES**

In determining whether impacts to agricultural resources are significant environmental effects, lead agencies may refer to the California Agricultural Land Evaluation and Site Assessment Model (1997) prepared by the California Department of Conservation as an optional model to use in assessing impacts on agriculture and farmland. In determining whether impacts to forest resources, including timberland, are significant environmental effects, lead agencies may refer to information compiled by the California Department of Forestry and Fire Protection regarding the state's inventory of forest land, including the Forest and Range Assessment Project and the Forest Legacy Assessment project; and forest carbon measurement methodology provided in Forest Protocols adopted by the California Air Resources Board. --Would the project:

- |  |                          |                          |                                     |                                     |
|--|--------------------------|--------------------------|-------------------------------------|-------------------------------------|
| a) Convert Prime Farmland, Unique Farmland, or Farmland of Statewide Importance (Farmland), as shown on the maps prepared pursuant to the Farmland Mapping and Monitoring Program of the California Resources Agency, to non-agricultural use?   | <input type="checkbox"/> | <input type="checkbox"/> | <input checked="" type="checkbox"/> | <input type="checkbox"/>            |
| b) Conflict with existing zoning for agricultural use, or a Williamson Act Contract?   | <input type="checkbox"/> | <input type="checkbox"/> | <input type="checkbox"/>            | <input checked="" type="checkbox"/> |
| c) Conflict with existing zoning for, or cause rezoning of, forest land (as defined in Public Resources Code section 12220(g)), timberland (as defined by Public Resources Code section 4526), or timberland zoned Timberland Production (as defined by Government Code Section 51104(g))? | <input type="checkbox"/> | <input type="checkbox"/> | <input type="checkbox"/>            | <input checked="" type="checkbox"/> |
| d) Result in the loss of forest land or conversion of forest land to non-forest use?   | <input type="checkbox"/> | <input type="checkbox"/> | <input type="checkbox"/>            | <input checked="" type="checkbox"/> |
| e) Involve other changes in the existing environment which, due to their location or nature, could result in conversion of Farmland, to non-agricultural use or conversion of forest land to non-forest use?   | <input type="checkbox"/> | <input type="checkbox"/> | <input checked="" type="checkbox"/> | <input type="checkbox"/>            |

**Summary of Impacts Identified in the MEIR:**

The MEIR noted that the EIR prepared for the 1993 general plan update addressed the agricultural impacts that would result from designation of non-agricultural uses in areas of existing farmland. This included areas designated for urban uses, including designated specific plan areas (SPAs). The proposed Mesquite Lake SPA designation was specifically addressed in the Agriculture section of the EIR, which stated that this was an area of poor agricultural land, in spite of its important Farmland designation. The evaluation of agricultural impacts included the following statement:

The direct loss of 4,260 acres of Important Farmland in the Mesquite Lake SPA would be justified if a major portion of this proposed industrial park is devoted to agricultural-related operations. In particular, as detailed in the Agricultural Element, the County requires and would benefit from additional agricultural processing and packaging facilities. The development of packaging and processing facilities in the Mesquite Lake SPA would stabilize and increase the value of farm products; increase local employment; diversify the overall agricultural industry and thereby stabilize the local economy; and lower the prices of many locally produced commodities for local consumption.

The MEIR noted that approval of the Specific Plan would commit nearly the entire property, some 4,780 acres (of which approximately 1,420 acres is currently under cultivation), to non-agricultural use, and would include all the project lands designated as Prime Farmland and Farmland of Statewide Importance. It is important to note, however, that due to poor soil conditions, farmlands within the project that are designated as Prime or of Statewide Importance are less productive than these designations would imply. The Mesquite Lake Specific Plan, including the GPA

Potentially Significant Impact (PSI)	Less Than Significant With Mitigation Incorporated (LTSWMI)	Less Than Significant Impact (LTSI)	No Impact (NI)
--------------------------------------	---	-------------------------------------	----------------

to change approximately 570 acres from the Agriculture designation to SPA, would not significantly impact the County's agricultural resources and no mitigation would be required.

Additionally, no portion of the project is subject to a California Land Conservation Act (Williamson Act) contract for agricultural preservation; however, the County has been very active in preservation of farmland under the Williamson Act program (County 2006).

**Impacts Related to the Proposed Project:**

- a) Convert Prime Farmland, Unique Farmland, or Farmland of Statewide Importance (Farmland), as shown on the maps prepared pursuant to the Farmland Mapping and Monitoring Program of the California Resources Agency, to non-agricultural use?

**a) Consistent with the MEIR, Less than Significant.** The Proposed Project is located on land classified as Prime Farmland, Farmland of Statewide Importance, and Local Importance (DOC 2022a). Approximately 163 acres of the site is classified as Farmland of Local Importance, with 5 acres classified as Prime Farmland, and 106 acres of Statewide Importance. Additionally, a majority of the site is currently utilized for agricultural production. Currently no agricultural production exists on the Local Importance, with the Statewide and Prime Farmland being utilized for agricultural production. However, impacts associated with conversion of this land from agricultural uses to non-agricultural uses, were evaluated in the MEIR, and it was concluded that no impacts to agricultural land would occur due to poor soil conditions and farmlands within this area being less productive than their designation would imply. Implementation of the Project would be consistent with the MEIR, would not result in any new impacts that were not previously analyzed, and impacts would be less than significant.

- b) Conflict with existing zoning for agricultural use, or a Williamson Act Contract?

**b) Consistent with the MEIR, No Impact.** As previously mentioned, the MEIR noted that no portion of the Mesquite Lake Specific Plan was identified in containing any land subject to the Williamson Act. Additionally, since 2006, no new lands have been subject to the provisions of a Williamson Act contract (DOC 2022b). No land within the Project site is zoned for agricultural use, as the current zoning for the site is Mesquite Lake Specific Plan consisting of Light Industrial, Medium Industrial, and Government/Special Public (County 2006). Implementation of the Project would be consistent with the MEIR and would not result in any new impacts to a Williamson Act Contract or existing agricultural zoning and no impacts would occur.

- c) Conflict with existing zoning for, or cause rezoning of, forest land (as defined in Public Resources Code section 12220(g)), timberland (as defined by Public Resources Code section 4526), or timberland zoned Timberland Production (as defined by Government Code Section 51104(g))?

- d) Result in the loss of forest land or conversion of forest land to non-forest use?

**c) and d) Consistent with the MEIR, No Impact.** Currently no land within the Mesquite Lake Specific Plan is zoned for forest land or timberland (County 2006). As discussed in Threshold (b), the Project site is zoned Mesquite Lake Specific Plan consisting of Light Industrial, Medium Industrial, and Government/Special Public (County 2006). Additionally, no forests or tree production occurs on the site, therefore no impacts to forest land or timberland would occur.

- e) Involve other changes in the existing environment which, due to their location or nature, could result in conversion of Farmland, to non-agricultural use or conversion of forest land to non-forest use?

**e) Consistent with the MEIR, Less than Significant.** As mentioned in Threshold (a) above, impacts associated with conversion of this land from agricultural uses to non-agricultural uses, were evaluated in the MEIR, and it was concluded that no impacts to agricultural land would occur due to poor soil conditions and farmlands within this area being less productive than their designation would imply. Implementation of the Project would not result in any new impacts that were not previously analyzed and would be consistent with the MEIR, and impacts would be less than significant.

**III AIR QUALITY**

Where available, the significance criteria established by the applicable air quality management district or air pollution control district may be relied upon to the following determinations. Would the Project:

- a) Conflict with or obstruct implementation of the applicable air quality plan?

	Potentially Significant Impact (PSI)	Less Than Significant With Mitigation Incorporated (LTSWMI)	Less Than Significant Impact (LTSI)	No Impact (NI)
b) Result in a cumulatively considerable net increase of any criteria pollutant for which the project region is non-attainment under an applicable federal or state ambient air quality standard?	<input type="checkbox"/>	<input type="checkbox"/>	<input checked="" type="checkbox"/>	<input type="checkbox"/>
c) Expose sensitive receptors to substantial pollutants concentrations?	<input type="checkbox"/>	<input type="checkbox"/>	<input checked="" type="checkbox"/>	<input type="checkbox"/>
d) Result in other emissions (such as those leading to odors adversely affecting a substantial number of people)?	<input type="checkbox"/>	<input type="checkbox"/>	<input checked="" type="checkbox"/>	<input type="checkbox"/>

**Summary of Impacts Identified in the MEIR:**

The MEIR included an analysis of the existing air quality conditions at the time of preparation of the MEIR, and an impact analysis for construction and operation based on full build out of the Specific Plan.

The MEIR noted that at the time of preparation, neither Imperial County nor the APCD had quantitative thresholds for determining significance of impact under CEQA. On federal projects in a marginal O3 (8-hour) nonattainment area, thresholds for the presumption that a project would conform to the State Implementation Plan (SIP) were 100 tons per year for both NOX and ROC. In recognition of the State "nonattainment" designation for O3 and to be conservative, thresholds of 50 tons per year for NOX and ROC were used. The federal SIP conformity threshold for PM10 in a federal "nonattainment-serious" area was 70 tons per year. Because the Salton Sea Air Basin (SSAB) was in compliance with both State and federal standards, the conformity threshold for CO of 100 tons per year was used as a significance guideline.

**Construction**

The MEIR noted that the principal concern for potential impacts during construction would be the generation of fugitive dust and particulates, including PM10 and PM2.5. Grading, earth moving, driving on unpaved haul roads, and exposure of graded surfaces and stockpiles to the wind would be the major sources of fugitive dust. Windblown dust and dust from unpaved roads are the predominant sources of particulates in Imperial County. Construction equipment operations would result in emissions of O3 precursors NOX and ROC. The quantity of emissions would be dependent on the level of activity and number of concurrent projects, as well as other parameters. The MEIR concluded that to avoid a significant air quality impact, the anticipated quantity of emissions should be calculated and compared with the guidelines for significant impact.

**Operation**

The MEIR noted that the operation of many industrial facilities has the potential to emit non-negligible amounts of regulated air pollutants. To protect the public and maintain air quality, the APCD has a process for the permitting of all sources with the potential to emit such pollutants. In addition, vehicle operations would result in the regional emissions of O3 precursors NOX and ROC. The quantity of emissions would be dependent on the types of vehicles, number of trips, and average trip distance, as well as other parameters. The MEIR concluded that for all proposed developments within the Specific Plan, the anticipated quantity of emissions should be calculated and compared with the guidelines for significant impact specified above.

**Odors**

The MEIR noted that there are very few residences within 1 mile of the Specific Plan and, therefore, it is unlikely that odors emitted from project facilities would result in a significant impact. However, projects within the Specific Plan that include composting, sorting of recyclables, or biosolids transformation would require that an Odor Impact Minimization Plan (OIMP) be prepared in order to obtain a Solid Waste Facilities Permit (SWFP). To avoid the potential for significant impact to workers at these and other on-site properties, as well as off-site populations, a mitigation measure for potential odor impact is included below.

The MEIR concluded that with implementation of the following mitigation measures, future projects would avoid conflict with local air quality plans, prevent violation or a substantial contribution to an existing or projected air quality violation, protect sensitive receptors from substantial air pollutant concentrations, and minimize objectionable odors. However, the MEIR also concluded that individual air quality analyses would be required for each project within the Specific Plan and additional mitigation measures may be required.

**Mitigation Measure 4.3.1:** Prior to issuance of any grading permit or building permit, the applicant shall provide evidence that construction specifications incorporate the requirement to comply with APCD Regulation VIII, Fugitive Dust Rules and the standard and discretionary mitigation measures for construction equipment and fugitive PM10 control for construction activities in Section 7.1 of the Imperial County APCD CEQA Air Quality Handbook.

**Mitigation Measure 4.3.2:** Prior to issuance of any grading permit or building permit, the applicant shall provide evidence that construction plans and specifications incorporate elements that ensure the paving, planting, or equivalent long-term dust stabilization of all surfaces that would be disturbed during construction.

**Mitigation Measure 4.3.3:** Prior to issuance of any grading permit or building permit, the applicant shall provide an analysis to APCD of forecast construction equipment emissions attributable to the project as well as all foreseeable concurrent construction within 1 mile of the project. If forecast direct or cumulative NOX or ROC emissions would exceed 50 tons per year, the applicant shall incorporate feasible emission reduction



Potentially Significant Impact (PSI)	Less Than Significant With Mitigation Incorporated (LTSWMI)	Less Than Significant Impact (LTSI)	No Impact (NI)
--------------------------------------	---	-------------------------------------	----------------

measures to reduce emissions to less than 50 tons per year to the satisfaction of the Air Pollution Control Officer. If emission reduction measures do not provide adequate reduction, applicant shall conduct further project-specific environmental review pursuant to CEQA or provide evidence from APCD that forecast emissions from construction activities would not cause a significant air quality impact.

**Mitigation Measure 4.3.4:** Prior to issuance of any building permit, the applicant shall provide evidence from APCD that the project complies with APCD rules for permitting of new or modified stationary sources, or is exempt from permitting requirements.

**Mitigation Measure 4.3.5:** Prior to issuance of any discretionary approval or building permit, the applicant shall provide information to the Planning and Development Services Director on average daily truck and employees trips and one-way average miles traveled. Based on this information, the Planning and Development Services Director, in consultation with the Air Pollution Control Officer, may require an analysis of potential long-term vehicle emissions attributable to the project. If forecast NOX or ROC emissions would exceed 55 pound per day, the applicant shall be required to incorporate feasible emission reduction measures to reduce emissions to a less than significant level. If emission reduction measures do not provide adequate reduction, applicant shall conduct further project-specific environmental review pursuant to CEQA or provide evidence from APCD that forecast long-term vehicle emissions from the project would not cause a significant air quality impact.

**Mitigation Measure 4.3.6:** Prior to issuance of any building permit, the permit applicant shall provide, for approval by the County Planning/Building Department, a description of the odor-producing potential of the facility and the controls that would be incorporated into the project to avoid an impact to on-site or off-site receptors. Uses proposing composting, sorting of recyclables, or biosolids transformation, shall be required to obtain approval by the Local Enforcement Agency (LEA) at the County Environmental Health Services Division (EHS), which may require preparation of an Odor Impact Minimization Plan (OIMP) and approval of a Solid Waste Facilities Permit (SWFP).

**Impacts Related to the Proposed Project:**

**Construction Assumptions**

Construction of the Project is expected to begin sometime in 2024 and would continue for approximately 18 months if the site is built-out under a single construction effort. Site preparation is anticipated to take approximately 2 months, grading to take approximately 2 months, and vertical construction to occur over approximately 14 months. Project build-out is expected in 2025. It should be noted depending on market demands, the Project construction may occur incrementally over time though analysis under a single effort is considered worst case.

Site preparation will include clearing and grubbing, which would require export to a local recycling area. The land development includes grading to create rough graded streets, native soil preparatory work for track facilities, and pads for new construction. The site preparation will include an estimated 150,000 cubic yards (CY) of cut and 150,000 CY of fill; soil will be balanced on site.

The Project would require material imports which would include 140,000 CY of granular select fill for use underneath concrete building pads, an import of approximately 315,000 tons of ballast or 410,000 CY of material to construct the three (3) loop tracks and 28,000 tons or 32,000 CY of road base for the Industrial Street roadway, which will be surface finished with asphalt concrete. In all, the Project would import 582,000 CY of material and export roughly 1,000 CY of grubbed material.

A concrete and rebar bridge/over-pass or a culvert/under-pass may ultimately be built to take trucks to and from the central part of the project if full loop tracks are built. Prior to the full loop tracks being constructed, a private roadway will be constructed for access to the central part of the Project.

Table 4 below shows the expected timeframes and construction equipment necessary to fully construct all the project infrastructure, structures, and rail lines. Additionally, the project would implement several design features which are identified on the following page. These design features were assumed within all modeling and therefore would be required and considered a condition to this Project's approval.

**Table 4: Expected Construction Equipment**

Equipment Type	Start Date	End Date	Quantity
<b>Site Preparation</b>	1/1/2024	3/1/2024	
Rubber Tired Dozers			3
Tractors/Loaders/Backhoes			4
<b>Grading</b>	2/1/2024	4/3/2024	
Excavators			2
Graders			1
Rubber Tired Dozers			1

Potentially Significant Impact (PSI)      Less Than Significant With Mitigation Incorporated (LTSWMI)      Less Than Significant Impact (LTSI)      No Impact (NI)

Equipment Type	Start Date	End Date	Quantity
Scrapers			2
Tractors/Loaders/Backhoes			2
<b>Building Construction</b>	4/4/2024	6/30/2025	
Aerial Lifts			2
Cranes			2
Rough Terrain Forklifts			2
Tractors/Loaders/Backhoes			3
Welders			1
<b>Paving</b>	4/4/2024	5/8/2024	
Pavers			2
Paving Equipment			2
Rollers			2
<b>Architectural Coating</b>	4/1/2025	4/1/2025	

**Construction Impacts**

Construction emissions in pounds per day from the construction operations and equipment identified in Table 4 above is shown in Table 5 below. The project construction model includes project design features listed below:

**Table 5: Expected Construction Emissions without Mitigation – Lb/Day**

Year	ROG	NO <sub>x</sub>	CO	SO <sub>x</sub>	PM <sub>10</sub> (Dust)	PM <sub>10</sub> (Exhaust)	PM <sub>10</sub> (Total)	PM <sub>2.5</sub> (Dust)	PM <sub>2.5</sub> (Exhaust)	PM <sub>2.5</sub> (Total)
2024	69.93	66.19	50.26	0.16	1,100.65	2.65	1,101.46	110.82	2.44	111.57
2025	69.64	29.54	38.21	0.14	1,100.65	0.73	1,101.38	110.82	0.68	111.57
Significance Threshold (lb/day)	75	100	550	150	-	-	150	-	-	150
ICAPCD Impact?	No	No	No	No	-	-	Yes	-	-	No

Based on the modeling results, the project would exceed ICAPCD standards for PM10 and is largely attributed to the 24,250 CY of ballast and roadways that will be imported to the site during Grading and Building Construction activities. It was found that all PM10 impacts could be reduced to less than significant if 100% of all hauling trucks were to utilize paved roadway sections only. A haul route for stone and construction materials would need to be prepared to the satisfaction of ICAPCD showing the route is 100% paved. Table 6 shows the mitigated emissions, which are less than significant.

**MM AQ-1:** The Project shall prepare a haul route plan for all construction materials to include ballast stone, road base or import materials requiring hauling. The haul route plan shall be approved to the satisfaction of ICAPCD and shall be over a 100% paved roadway surface. In addition, all employees working on the Green Valley Logistics Project shall be trained and sign off that each trip to and from the site would be on 100% paved surfaces.

Potentially Significant Impact (PSI)      Less Than Significant With Mitigation Incorporated (LTSWMI)      Less Than Significant Impact (LTSI)      No Impact (NI)

**Table 6: Expected Construction Emissions with Mitigation – Lb/Day**

Year	ROG	NO <sub>x</sub>	CO	SO <sub>x</sub>	PM <sub>10</sub> (Dust)	PM <sub>10</sub> (Exhaust)	PM <sub>10</sub> (Total)	PM <sub>2.5</sub> (Dust)	PM <sub>2.5</sub> (Exhaust)	PM <sub>2.5</sub> (Total)
2024	69.14	55.68	62.60	0.16	14.41	0.42	14.83	6.58	0.42	6.99
2025	68.96	32.54	41.73	0.14	6.11	0.33	6.44	1.67	0.32	1.99
Significance Threshold (lb/day)	75	100	550	150	-	-	150	-	-	150
ICAPCD Impact?	No	No	No	No	-	-	No	-	-	No

**Odor Emissions**

Potential onsite odor generators would include short term construction odors from activities such as paving and possibly painting as well as exhaust from construction equipment. Odors created during short term construction activities would most likely be from placing asphalt which has a slight odor from the bitumen and solvents used within hot asphalt. Since the nearest sensitive receptor is located just over 0.25 mile from the site, a less than significant odor impact from construction is expected.

**Operational Emissions**

Routine operations and maintenance of the facility will include preventative maintenance and repairs of any damaged or otherwise inoperable equipment on an as-needed basis. The operation and maintenance staff will monitor the facility operations over the Project life to ensure that the logistics center is operating to meet design standards. Approximately 56 full-time employees are expected each day of the week during Project operations to cover the below shown elements of the Project, with approximately two shifts per day (5am to 1pm and 11am to 7pm). The below shown Project elements will be developed in accordance with Mesquite Lake Specific Plan and County development standards.

Based on the projected traffic volumes estimated by the Project Traffic Engineer, the proposed project would generate approximately 107 regular employee ADT and as many as 436 ADT from heavy trucks. As noted by the Project traffic engineer, the Green Valley Logistics Project would reduce regional vehicle miles travelled since the Logistics Center essentially would allow for train containers to bulk transfer goods between the Los Angeles Area to Imperial County which are currently being carried via trucks mostly. The regional truck mileage associated with the Project site would essentially drop regional trips by more than a factor of 2/3 or 25miles vs 80 miles previously. Since each truck using the Green Valley Logistics center would reduce miles traveled within the County of Imperial, only the employee trips were modeled within CalEEMod.

As was noted earlier within the construction methodology section, CalEEMod includes an assumption for roads within imperial county to be only 50% paved. Project trips would only be on paved road sections or a 100% paved scenario in CalEEMod. To be conservative however, this analysis assumes a 90% paved roadway condition in the modeled inputs.

Operational air quality emission sources would also include area sources such as landscaping, consumer products and architectural coatings during maintenance, energy sources from electrical usage, solid waste from trash generation, and water uses, which are calculated within CalEEMod.

The Project area is currently being used for agricultural purposes and will use 630 acre-feet of water each year. The Project would reduce water consumption by 450 acre-feet per year based on a historical use factor 5.25 acre-feet per acre per year and would use 180 acre-feet annually at buildout. CalEEMod assumes 180 acre-feet of water usage annually by the project and no credit for the 450 acre-feet was taken in this analysis.

**Operational Impacts**

The Green Logistics Development Project would bring roughly 4 locomotives into the 1.75 mile loop daily. These trains would be expected to generate air quality emissions daily. Table 7 below shows the estimated emissions generated from these locomotives daily.

**Table 7: Expected Rail Emissions**

PM10	NO <sub>x</sub>	CO	Units
0.16836	6.1587	1.28	(g/bhp-hr)
4000	4000	4000	horsepower
4	4	4	trains
1.75	1.75	1.75	miles

Potentially Significant Impact (PSI)      Less Than Significant With Mitigation Incorporated (LTSWMI)      Less Than Significant Impact (LTSI)      No Impact (NI)

PM10	NOx	CO	Units
1	1	1	miles/hour
0.1	0.1	0.1	Load Factor
1.75	1.75	1.75	hours
6300	6300	6300	Seconds
0.0748	2.7372	0.5689	Grams/sec
471.41	17244.36	3584.00	Grams
<b>1.04</b>	<b>38.02</b>	<b>7.90</b>	<b>Pounds/day</b>

Where available, the significance criteria established by the applicable air quality management district or air pollution control district may be relied upon to the following determinations. Would the Project:

- a) Conflict with or obstruct implementation of the applicable air quality plan?

**a) Consistent with the MEIR; Less than Significant Impact With Mitigation.** The ICAPCD CEQA Air Quality Handbook calls for a consistency analysis with the regional clean air plans, namely ozone and PM10 attainment demonstration plans, for large residential and commercial developments that are required to develop an EIR. Projects that are projected to exceed ICAPCD thresholds of significance for its operations are considered large developments and are required to demonstrate consistency with regional air quality plans.

As discussed above, the project would exceed ICAPCD standards for PM10 and is largely attributed to the 24,250 CY of ballast and roadways that will be imported to the site during Grading and Building Construction activities. It was found that all PM10 impacts could be reduced to less than significant if 100% of all hauling trucks were to utilize paved roadway sections only. A haul route for stone and construction materials would need to be prepared to the satisfaction of ICAPCD showing the route is 100% paved.

**Mitigation Measure AQ-1:** The Project shall prepare a haul route plan for all construction materials to include ballast stone, road base or import materials requiring hauling. The haul route plan shall be approved to the satisfaction of ICAPCD and shall be over a 100% paved roadway surface. In addition, all employees working on the Green Valley Logistics Project shall be trained and sign off that each trip to and from the site would be on 100% paved surfaces.

With the implementation of mitigation measure **AQ-1**, impacts would be less than significant.

- b) Result in a cumulatively considerable net increase of any criteria pollutant for which the project region is non-attainment under an applicable federal or state ambient air quality standard?

**b) Consistent with the MEIR; Less than Significant Impact.** Cumulative impacts would exist when there are either direct air quality impacts or when multiple construction projects occur within the same area simultaneously. To illustrate this, if a project were to produce air quality emissions simultaneous to a nearby construction project the addition of both project emissions to the environment could exceed significance thresholds. For this project, the construction emissions were found to be less than significant as shown in Table 3.1 above. These impacts were discovered to be regional as opposed to onsite since these impacts would be on Imperial County roads, which are not paved. The Proposed Project calls for specific mitigation measures (AQ-1) to require that all hauling and employee trips during construction utilize only 100% paved roadway sections. It will be up to the Construction Contractor to ensure that a haul route plan is approved by the ICAPCD by showing that the entire route is 100% paved. In addition, the Construction Contractor shall educate construction staff to only drive on 100% paved roads when traveling to or from the Project site.

The Project site is zoned industrial, and the Proposed Project has been designed to be consistent with this zoning designation. The Proposed Project would generate less than significant direct air quality impacts and by the very nature of the Project would reduce regional truck trips by greater than two thirds (2/3) since each truck trip would reduce mileage from roughly 80 miles per day to only 25 for the same tasks since the emissions would be bulk via train instead of individually trucked into the Imperial County area from the Los Angeles area. Impacts would be less than significant.

- c) Expose sensitive receptors to substantial pollutants concentrations?

**c) Consistent with the MEIR; Less than Significant Impact.** Sensitive receptors are people who would be more susceptible to air pollution than the general population, such as children, athletes, the elderly, and the chronically ill. Examples of land uses where



Potentially Significant Impact (PSI)	Less Than Significant With Mitigation Incorporated (LTSWMI)	Less Than Significant Impact (LTSI)	No Impact (NI)
--------------------------------------	---	-------------------------------------	----------------

substantial numbers of sensitive receptors are often found are schools, daycare centers, parks, recreational areas, medical facilities, nursing homes, and convalescent care facilities. Residential areas are also considered to be sensitive to air pollution because residents (including children and the elderly) tend to be at home for extended periods of time, resulting in sustained exposure to pollutants. The closest sensitive receptor is a rural residence near the intersection of State Highway 86 and La Brucherie Road, approximately 2,000 feet southwest of the center of activity of the Project Site. This residence is too far away to be affected by emissions from the proposed Project, and therefore impacts would be less than significant.

- d) Result in other emissions (such as those leading to odors adversely affecting a substantial number of people)?
- d) Consistent with the MEIR; Less than Significant Impact.** As discussed above, potential onsite odor generators would include short-term construction odors from activities such as paving and architectural coating as well as exhaust from construction equipment. Odors created during short-term construction activities would most likely be from placing asphalt, which has a slight odor from the bitumen and solvents used within hot asphalt. Since the nearest sensitive receptor is located just over 0.25 miles from the site, a less than significant odor impact from construction is expected.

**IV BIOLOGICAL RESOURCES Would the project:**

- |   |                          |                                     |                                     |                          |
|---|--------------------------|-------------------------------------|-------------------------------------|--------------------------|
| a) Have a substantial adverse effect, either directly or through habitat modifications, on any species identified as a candidate, sensitive, or special status species in local or regional plans, policies or regulations, or by the California Department of Fish and Wildlife or U.S. Fish and Wildlife Service? | <input type="checkbox"/> | <input checked="" type="checkbox"/> | <input type="checkbox"/>            | <input type="checkbox"/> |
| b) Have a substantial adverse effect on any riparian habitat or other sensitive natural community identified in local or regional plans, policies, regulations, or by the California Department of Fish and Wildlife or U.S. Fish and Wildlife Service?   | <input type="checkbox"/> | <input checked="" type="checkbox"/> | <input type="checkbox"/>            | <input type="checkbox"/> |
| c) Have a substantial adverse effect on state or federally protected wetlands (including, but not limited to, marsh, vernal pool, coastal, etc.) through direct removal, filling, hydrological interruption, or other means?  | <input type="checkbox"/> | <input type="checkbox"/>            | <input checked="" type="checkbox"/> | <input type="checkbox"/> |
| d) Interfere substantially with the movement of any resident or migratory fish or wildlife species or with established native resident or migratory wildlife corridors, or impede the use of native wildlife nursery sites?   | <input type="checkbox"/> | <input checked="" type="checkbox"/> | <input type="checkbox"/>            | <input type="checkbox"/> |
| e) Conflict with any local policies or ordinance protecting biological resource, such as a tree preservation policy or ordinance?   | <input type="checkbox"/> | <input type="checkbox"/>            | <input checked="" type="checkbox"/> | <input type="checkbox"/> |
| f) Conflict with the provisions of an adopted Habitat Conservation Plan, Natural Community Conservation Plan, or other approved local, regional, or state habitat conservation plan?  | <input type="checkbox"/> | <input type="checkbox"/>            | <input checked="" type="checkbox"/> | <input type="checkbox"/> |

**Summary of Impacts Identified in the MEIR:**

At the time the MEIR was prepared, the existing conditions described were based on the results of the site assessment prepared in 2004. Observations were made for sensitive species, though no focused surveys pursuant to the U.S. Fish and Wildlife (USFWS) protocols were conducted.

Three vegetation communities were found to occur within the SPA: bush seepweed-iodine bush scrub (total of 729.7 acres, with 562.2 acres disturbed), tamarisk scrub (total of 287.5 acres, with 64.5 acres as disturbed and 161.2 classified as tamarisk scrub/ponds), and disturbed wetlands (total of 6.6 acres of disturbed wetlands). The remaining lands were occupied by agriculture (2,244.3 acres, with 1,336.2 under active agriculture, 268.10 as fallow agriculture, and 640 acres of aquaculture facility and developed and disturbed areas (1,831.9 acres).

**Wildlife**

A total of 26 wildlife species were observed or detected within the SPA in the bush seepweed-iodine bush scrub habitat, tamarisk scrub communities, disturbed wetland area, and within the agricultural fields. While the developed and disturbed areas do not support native vegetation, these areas provide access to perches, roosts or covers for various disturbance-adapted animal species. These species are detailed within the MEIR.

Potentially Significant Impact (PSI)	Less Than Significant With Mitigation Incorporated (LTSWMI)	Less Than Significant Impact (LTSI)	No Impact (NI)
--------------------------------------	---	-------------------------------------	----------------

**Sensitive Habitats**

Sensitive habitats within the MEIR were identified to be areas that were regulated by the U.S. Army Corps of Engineers (ACOE) as federal wetlands or waters under Section 404 of the Clean Water Act (CWA), regulated by the California Department of Fish and Wildlife (formerly known as the California Department of Fish and Game(CDFG)) as State wetlands or waters under Section 1600 of the CDFG code, and/or were areas worthy of consideration by the California Natural Diversity Database (CNDDDB). While some portions of the SPA were found to possibly fall under ACOE and CDFG jurisdiction, none of the habitats were found to be rarer or worthy of consideration. Implementation of SPA would result in disturbance to bush seepweed-iodine bush scrub, tamarisk scrub, and disturbed wetlands. However, these impacts to the vegetation communities (or portions thereof) would be significant if they were qualified as federal and/or State jurisdictional waters or wetlands. Agricultural lands within the SPA would be impacted by future development; however, impacts would not be significant because these lands were not considered as sensitive. However, there would indirect and temporary impacts during development. Therefore, the following mitigation measures provided in the MEIR, would address these impacts to vegetation, including wetland habitats, that could arise during construction generated erosion, sedimentation, and fugitive dust.

**Mitigation Measure 4.5.1:** Prior to approval of any discretionary permit, final map, grading plan, or building permit for any phase or unit of development within the Specific Plan, the Planning and Development Services Director shall determine whether the Project could potentially impact wetlands or waters of the U.S. Where the Planning and Development Services Director determines that a potential impact could occur, the applicant shall provide evidence to the Planning and Development Services Director that a qualified biologist has inspected the site and made a determination regarding the presence of wetlands or waters of the U.S. If determined to be present, the following actions shall be taken: (1) a formal wetland and waters of the U.S. determination and delineation shall be conducted by trained personnel to determine the extent of these resources on the Project site; (2) any required ACOE permit pursuant to Section 404 of the CWA and certification from the RWQCB pursuant to Section 401 of the CWA shall have been issued; and (3) any required Streambed Alteration Agreement from the CDFG pursuant to Section 1600 of the California Fish and Game Code and either a Statewide General Order (2004-0004-DWQ) or Form 200-Report of Waste Discharge (ROWD) from the RWQCB under Section 13260 of the California Water Code has been issued.

As part of the permitting process for impacts to either federal or State wetlands or waters, mitigation in the form of habitat compensation (either creation, restoration, or enhancement) would be required. Because of the federal and State policy of a no net loss of wetland functions and values, habitat creation at least equal to the amount of jurisdictional habitat impacted, shall be included with the habitat compensation program. The ultimate mitigation replacement ratios would be determined through consultation with the appropriate resource agencies during the permitting process.

**Mitigation Measure 4.5.2:** Prior to approval of any discretionary permit, final map, grading plan, or building permit for any phase or unit of development within the Specific Plan, the Planning and Development Services Director shall determine whether the Project could potentially impact rare plants. Where the Planning and Development Services Director determines that a potential impact could occur, the applicant shall provide evidence to the Planning and Development Services Director that focused rare plant surveys by a qualified biologist were conducted during the appropriate season. If these surveys detect sensitive plant species and determine that significant impacts would occur, the County would require mitigation in the form of habitat compensation as determined appropriate.

**Mitigation Measure 4.5.3:** Prior to construction within the Specific Plan, the applicant shall provide evidence to the Planning and Development Services Director that standard best management practices (BMPs) have been installed to avoid erosion and sedimentation into federal and/or State jurisdictional waters and wetlands. It is anticipated that such BMPs would be components of a Stormwater Prevention Pollution Plan required as a component of the State Water Resources Control Board's NPDES General Permit, which prevents construction pollutants from contacting storm water and with the intent of keeping all products of erosion from moving off-site into receiving waters. A National Pollutant Discharge Elimination System General Permit is required for construction projects that encompass more than 5 acres of soil disturbance that would discharge stormwater into waters of the U.S.

**Sensitive Plant Species**

Sensitive plants were listed to be as endangered, threatened, or proposed for listing as endangered or threatened by the USFWS, CDFW, and California Native Plant Society (CNPS) Inventory of Rare and Endangered Plants in California. Based on a CNDDDB search at the time of the preparation of the MEIR, no federally or State listed or proposed for listing plant species were found to be within the SPA. Two species, Abram's spurge (*Chamaesyce abramsiana*) and Sand food (*Pholisma sonora*) were found near the Project site; however, they were considered to have low potential to occur. Sensitive plant species present within the SPA would be impacted, but the intensity of the impact would be based on current status and population size of the population. However, as noted in the MEIR, the potential for such species to be present is low.

**Sensitive Wildlife**

Sensitive wildlife was listed to be as endangered, threatened, proposed for listing, or candidates for listing by the USFWS and CDFW. The three sensitive wildlife species detected within the SPA were the burrowing owl (*Athene cunicularia*), prairie falcon (*Falco mexicanus*), and black-tailed jackrabbit (*Lepus californicus*). Six other sensitive species known from the region with a low to moderate potential to occur within the SPA are the federally endangered and State-threatened Yuma clapper rail (*Rallus longirostris yumanensis*), as well as the Colorado River toad (*Bufo alvarius*), flat-tailed horned lizard (*Phrynosoma mcallii*), ferruginous hawk (*Buteo regalis*), Crissal thrasher (*Toxostoma crissale*), and mountain plover (*Charadrius montanus*), which are State species of special concern.

Potentially Significant Impact (PSI)	Less Than Significant With Mitigation Incorporated (LTSWMI)	Less Than Significant Impact (LTSI)	No Impact (NI)
--------------------------------------	---	-------------------------------------	----------------

The MEIR concluded that implementation of the Specific Plan would directly impact wildlife such as the burrowing owl if proposed activities occur within 50 meters (160 feet) of occupied burrows, burrows and entrances are destroyed, or foraging habitat adjacent to burrows is degraded. Depending on the timing of development within the SPA, other bird species covered by the Migratory Bird Treaty Act (MBTA) may be impacted during the breeding season. Therefore, direct impacts would be significant if development were to occur during the nesting season (February 1 through September 30). While burrowing owl was not present at the time of the reconnaissance during the preparation of the MEIR within the Proposed Project site (or known as the Palo Verde Valley Disposal Service site in the MEIR), there is potential for them to colonize the site and therefore, impacts would be addressed with implementation of the following mitigation measure.

**Mitigation Measure 4.5.4:** Prior to grading or construction within the Specific Plan, the Planning and Development Services Director shall determine whether the Project could potentially impact burrowing owl. Where the Planning and Development Services Director determines that a potential impact could occur, the applicant shall engage the services of a biologist who has been determined by the USFWS as qualified to conduct burrowing owl surveys. An initial survey to determine the presence of burrowing owls shall be conducted between February and September. Prior to conduct of any burrowing owl survey, CDFG and the USFWS Office of Law Enforcement shall be contacted regarding use of the CBOC Guidelines for the survey and for relocation requirements. Information received from these agencies shall be provided in writing to the Development Services Director prior to commencement of any survey. The survey shall be conducted in accordance with the latest USFWS-approved guidelines for conducting burrowing owl surveys and the requirements of CDFG. A report on the results of the survey and recommended avoidance or mitigation measures shall be provided by the applicant to the USFWS, CDFG, and Imperial County Planning and Development Services Department. No clearing or ground-disturbing activities may be taken until the report and recommendations have been accepted by the USFWS, CDFG, and Imperial County Planning and Development Services Department. Relocation of found burrowing owls may be required. All burrowing owls found on the Project site shall be tagged by a USFWS-qualified burrowing owl biologist. If burrowing owl burrows are found present within construction areas and a 50-meter (165-foot) boundary of construction limits, avoidance is the preferred level of mitigation. Avoidance requires no disturbance within 50 meters (165 feet) of occupied burrows during the nonbreeding season (September 1 through January 31), no disturbance within 75 meters (250 feet) of occupied burrows during the breeding season (February 1 through August 31), and a minimum of 6.5 acres of foraging habitat preserved contiguous with occupied burrow sites for each pair of breeding burrowing owls.

If avoidance cannot be met, or no burrowing owls were detected during the first survey, a second survey shall be conducted no less than 30 days prior to any clearing, ground disturbance, or demolition of existing structures. If no burrowing owls are present, a third survey shall be conducted no less than five days prior to the commencement of construction and, if no burrowing owls are present, clearing, grading, demolition, or construction may commence. If burrowing owls are present at the time of the second survey and CDFG and USFWS Office of Law Enforcement concur, on-site passive relocation can be implemented wherein owls are encouraged to move from occupied burrows to alternate natural or artificial burrows beyond 50 meters from the impact zone, within a minimum of 6.5 acres of foraging habitat for each pair of relocated owls. The project biologist shall evaluate the suitability of nearby habitat, the availability of an existing or constructed alternate burrow for each burrow excavated, and the opportunity for preservation of the site, such as through a conservation easement that would be managed to promote burrowing owl use of the site. Relocation requires that owls should be excluded from burrows in the immediate impact zone and 50-meter buffer zone by installing one-way doors in burrow entrances, left in place for 48 hours before excavation. Relocation of owls should only be implemented during the nonbreeding season. Passive relocation may occur only if there is at least 6.5 acres of suitable nearby habitat for each relocated pair, and an alternate burrow for each burrow excavated.

**Mitigation Measure 4.5.5:** Prior to finalization of construction plans, timing of construction within the Specific Plan shall be scheduled, if feasible, to avoid the migratory bird nesting season in the Project area (February 1 through September 30). One week prior to commencement of construction activities outside of the nesting season, a focused bird nest survey shall be conducted within the plan area by a qualified biologist. Should any inactive or active bird nests be noted, the CDFG shall be notified pursuant to CDFG Code 3503 and appropriate actions shall be taken per CDFG recommendations.

However, if construction is necessary before close of the nesting season, the applicant could elect to have a qualified biologist conduct focused surveys for migratory bird nests throughout the individual project site in the season of planned construction. If this measure were selected, surveys shall be completed 1 week prior to commencement of construction. If surveys noted no sensitive wildlife species or migratory bird nests within the area of potential construction impact, construction could occur during the nesting season. If the biologist determines that habitat slated for removal/disturbance is being used for nesting at the time of the focused survey, disturbance shall be avoided until after the young have fledged from the nest and achieved independence. Results of focused bird nest surveys shall be submitted to the CDFG via a letter report. Should construction halt for any reason for longer than 1 week after initial commencement of activities, an additional focused survey for migratory bird nests would be required 1 week prior to recommencement of construction activities. If the surveys were completed and no sensitive wildlife species or nests were observed, construction could recommence during the nesting season.

Because construction equipment could have temporary impacts, such as construction noise above ambient levels in locations within 500 feet of an active nest covered by the MBTA, during the nesting season construction, activities are required to limit noise levels. The County precedent for construction noise is that projects shall not exceed a 60-decibel level at a nesting site of designated habitat.

**Wildlife Corridors**

Wildlife migration corridors are linear landscape features with sufficient width and buffer to allow the movement of animals between patches of



Potentially Significant Impact (PSI)	Less Than Significant With Mitigation Incorporated (LTSWMI)	Less Than Significant Impact (LTSI)	No Impact (NI)
--------------------------------------	---	-------------------------------------	----------------

similar undisturbed habitat or between habitats and vital resources. Regional corridors links two or more large areas of natural open space, while local corridors allow resident animals to access critical resources such as food, cover and water in smaller areas that may be isolated by urban development. The MEIR notes that the SPA is part of a major contiguous wildlife corridor in the County, situated between the New River and Alamo River, and south of the Salton Sea. Areas within the SPA provide bush seepweed-iodine bush and tamarisk scrub habitats that support wildlife movement and are part of an important avian and wildlife corridor to the Salton Sea. However, no direct impacts were found to occur within because the SPA is surrounded by large amounts of similar habitat and linkages that would be available for wildlife movement.

**Impacts Related to the Proposed Project:**

Chambers Group completed a literature review and reconnaissance-level survey for proposed work activities to develop the Green Valley Logistics Center (Proposed Project). The survey identified vegetation communities, potential for the occurrence of special status species, or habitats that could support special status wildlife species, and a preliminary jurisdictional delineation (PJD) of potential wetland and waters on site. Information contained in this Biological Technical Report is in accordance with accepted scientific and technical standards that are consistent with the requirements of United States Fish and Wildlife Service (USFWS), United States Army Corps of Engineers (USACE), Regional Water Quality Control Board (RWQCB), and the California Department of Fish and Wildlife (CDFW).

The Proposed Project is located between the City of Imperial and Brawley in Imperial County, California. The Proposed Project area is in the Brawley USGS 7.5-min quadrangle, within Section 31, Township 14 South, Range 14 East. The Proposed Project site is primarily an open space dominated by minimal topographical variation. The Proposed Project site is bordered by Dahlia Lateral 8 to the south, the Union Pacific Railroad to the west, State Route (SR) 86 to the west, and the Imperial Irrigation District (IID) Newside Drain No. 1-A to the north. The elevation at the Proposed Project site ranges from approximately 70 to 90 ft. below mean sea level (bmsl). The proposed development of the Study Area lies outside the scope of the IID Habitat Conservation Plan (HCP), according to communication with the County of Imperial.

**Special Status Plants**

Factors used to determine the potential for occurrence included the quality of habitat, elevation, and the results of the reconnaissance survey. In addition, the location of prior CNDDDB records of occurrence were used as additional data, but since the CNDDDB is a positive-sighting database, this data was used only in support of the analysis from the previously identified factors.

Current database searches (CDFW 2022 and CNPS 2022) resulted in zero federal- and/or state-listed threatened and/or endangered species documented to occur within 5 miles of the Study Area. However, two CNPS CRPR plants species that may potentially occur within the Mesquite Lake Specific Plan were listed on the MEIR and identified in the CNDDDB. No federal- and/or state-listed threatened and/or endangered or rare plant species were observed during the Chambers Group reconnaissance survey. After a literature review and an assessment of the various habitat types within the Study Area, it was determined that one species is considered absent, and one species has a low potential to occur within the Study Area. Factors used to determine potential for occurrence included the quality of habitat and the location of prior CNDDDB and MEIR records of occurrence.

The analysis of the MEIR records, CNDDDB search, and field survey resulted in one species considered to be absent on the Study Area:

- sand food (*Pholisma sonorae*)

Although observation records for this species occur within 5 miles of the Study Area and arrow weed was observed on site, which is one of the host species, sand food is considered absent from the Study Area, as the species is restricted to habitats or environmental conditions that do not occur within the Study Area.

The analysis of the MEIR records, CNDDDB search, and field survey resulted in one species with a low potential to occur on the Study Area:

- Abram's spurge (*Chamaesyce abramsiana*)

Historic records indicate one observation of Abram's spurge documented approximately 4 miles north of the Study Area (CDFW 2022). Although observation records for this species occur within 5 miles of the Study Area, Abram's spurge has a low potential for occurrence in the Study Area as habitats or environmental conditions needed to support this species are of poor quality.

**Special Status Wildlife**

A current database search (CNDDDB 2022) resulted in a list of three federal- and/or state-listed endangered or threatened, SSC, or otherwise special status wildlife species that may potentially occur within the Study Area (Appendix A Figure 6). An additional seven federal- and/or state-listed endangered or threatened Species of Concern or otherwise special status wildlife species that may potentially occur within the Mesquite Lake Specific Plan were listed on the MEIR. After a literature review and the assessment of the various habitat types within the Study Area, it was determined that seven species had a low potential to occur, one species had a moderate potential to occur, one species has a high potential to occur, and one was determined to be present, within the Study Area. Factors used to determine potential for occurrence included the quality of habitat and the location of prior CNDDDB and MEIR records of occurrence.



Potentially Significant Impact (PSI)	Less Than Significant With Mitigation Incorporated (LTSWMI)	Less Than Significant Impact (LTSI)	No Impact (NI)
--------------------------------------	---	-------------------------------------	----------------

The analysis of the MEIR records, CNDDDB search, and field survey resulted in one species considered absent since habitat and environmental conditions do not exist on the Study Area:

- Colorado River toad (*Bufo alvarius*)

The analysis of the MEIR records, CNDDDB search, and field survey resulted in five species with a low potential to occur on the Study Area since habitat is of poor quality and historical records of these species do not exist within 5 miles of the site:

- crissal thrasher (*Toxostoma crissale*)
- ferruginous hawk (*Buteo regalis*)
- flat-tailed horned lizard (*Phrynosoma mcallii*)
- prairie falcon (*Falco mexicanus*)
- western yellow bat (*Lasirus xanthinus*)
- Yuma clapper rail (*Rallus longirostris yumanensis*)

The analysis of the MEIR records, CNDDDB search, and field survey resulted in one species, mountain plover, with a moderate potential to occur on the Study Area as described below:

- mountain plover – SSC

The mountain plover (wintering) is listed as a California Species of Special Concern. This species breeds from the prairie and sagebrush country of north-central Montana, eastern Wyoming, and the area around southeastern Colorado. It winters from central California along the southern border southward to northern Mexico (Udvardy 1977). The mountain plover is a relatively nondescript shorebird with a short tail, long legs, plain brown plumage above, and whiter plumage below. Males develop a black patch on the forehead during the breeding season. This species is sometimes confused with the American golden plover, but unlike the American golden plover, the belly and underwing is a clean, white color and the legs are pale. Breeding habitats include semi-arid plains, grasslands, and plateaus. Mountain plovers often use prairie dog mounds as nest sites. Common wintering habitats consist of dry, barren ground, smooth dirt fields, agricultural fields, and shortgrass prairies. This species tends to form small flocks in the winter. It is one of the few shorebird species that prefers habitats away from water. It is an insectivore that eats flies, beetles, grasshoppers, crickets, and other insects. Populations are in decline due to overgrazing practices and are linked to declining prairie dog populations. The continued loss and alteration of habitats on breeding and wintering grounds are the primary threats to the mountain plover. The Proposed Project area contains suitable habitat for this species, no historical records of this species occur within 5 miles of the site, and no individuals were observed during the survey. Therefore, this species has a moderate potential to occur within the Study Area. This species was not observed during the field survey effort.

The analysis of the MEIR records, CNDDDB search, and field survey resulted in one species, San Diego black-tailed jackrabbit, with a high potential to occur on the Study Area.

- San Diego black-tailed jackrabbit

The San Diego black-tailed jackrabbit (*Lepus californicus bennettii*) is listed as a California Species of Special Concern. It is found on the coastal slope from Kern County, California south into Baja California, Mexico between sea level and approximately 3,000 feet amsl. It occurs in a variety of habitats, but prefers intermediate canopy stages of shrub habitats, grasslands, and open shrub, along herbaceous and tree edges within coastal sage scrub habitats in southern California. It also occurs on agricultural lands. This species does not typically burrow but sits in depressions called forms at the bases of shrubs by day (Howard 1995). No nest structure is typically built by this species. The Proposed Project area contains suitable habitat for this species, this species was detected in open bush seepweed-iodine bush scrub adjacent to the Union Pacific Railroad on the western side of the Specific Plan during the MEIR site assessment, and no individuals were observed during the survey. Therefore, this species has a high potential to occur within the Study Area. This species was not observed during the field survey effort.

One species, burrowing owl, was observed during the reconnaissance survey (Appendix A Figure 7) and is therefore considered present within the Study Area.

- burrowing owl

The burrowing owl (*Athene cunicularia*) is a California Species of Special Concern. It is broadly distributed across the western United States, with populations in Florida and Central and South America. The burrowing owl breeds in open plains from western Canada and the western United States, Mexico through Central America and into South America to Argentina (Klute 2003). This species inhabits dry, open, native or non-native grasslands, deserts, and other arid environments with low-growing and low-density vegetation (Ehrlich 1988). It may occupy golf courses, cemeteries, road rights-of way, airstrips, abandoned buildings, irrigation ditches, and vacant lots with holes or cracks suitable for use as burrows (TLMA 2006). Burrowing owls typically use burrows made by mammals such as California ground squirrels (*Spermophilus beecheyi*), foxes, or badgers (Trulio 1997). When burrows are scarce, the burrowing owl may use man-made structures such as openings beneath cement or asphalt pavement, pipes, culverts, and nest boxes (TLMA 2006). Burrowing owls often are found within, under, or near man-made structures. Prey sources for this species include small rodents; arthropods such as spiders, crickets, centipedes, and grasshoppers; smaller birds; amphibians; reptiles; and carrion. Threats to the burrowing owl include loss of nesting burrows,

Potentially Significant Impact (PSI)	Less Than Significant With Mitigation Incorporated (LTSWMI)	Less Than Significant Impact (LTSI)	No Impact (NI)
--------------------------------------	---	-------------------------------------	----------------

habitat loss, and mortality from motor vehicles. At least sixteen burrowing owls and burrowing owl signs were observed in the southwest portion of the Study Area, along the edges of the concrete-lined irrigation canal (Dahlia Lateral 8). Based on the preliminary design, no impacts to this portion of the canal are anticipated (temporary impacts to Dahlia Lateral 8 are proposed in the southeast corner of the Study Area).

In order to minimize potential impacts to sensitive species with the potential to occur within the Study Area, the following mitigation measures should be implemented prior to and during construction activities:

**BIO-1:** The construction footprint will be clearly defined with flagging and/or fencing and will be removed upon completion.

**BIO-2:** Prior to the start of construction activities, an environmental education program will be provided for all project personnel. The education program will include the following: (1) the potential presence of covered species and their habitats, (2) the requirements and boundaries of the project, (3) the importance of complying with avoidance and minimization measures, (4) environmentally responsible construction practices, (5) identification of sensitive resource areas in the field, and (6) problem reporting and resolution methods.

**BIO-3:** Preconstruction surveys will be conducted for the burrowing owl within 30 days of construction in all suitable habitat within the proposed Project Impact Areas.

**BIO-4:** If any ground disturbing activities are planned during the burrowing owl nesting season (approximately February 1 through August 31), avoidance measures shall include a no construction buffer zone of a minimum distance of 250 feet, consistent with the Staff Report on Burrowing Owl Mitigation (CDFG, 2012). Compliance shall be maintained with CDFW burrowing owl mitigation guidelines as detailed in the Staff Report on Burrowing Owl Mitigation (CDFG, 2012) or more recent updates, if available.

**BIO-5:** If project activities will occur during the bird-breeding season (February 15-August 31), a qualified biologist shall conduct a preconstruction nesting survey to ensure that no active nests are present within or adjacent to the project areas. If an active nest is observed that may be impacted by project-related activities, avoidance measures shall be implemented to avoid impacting the nest. Avoidance measures include delaying construction within the immediate vicinity of the active nest until the young have fledged or naturally failed, or instituting a buffer around the nest that prohibits construction activities to occur but allows construction to continue outside the buffer. The appropriate avoidance buffer is to be determined by the qualified biologist based on vegetative cover, topography, stage of nest or young development, and species type.

**BIO-6:** A preconstruction sweep for San Diego black-tailed jackrabbit should be conducted before initial construction activities. If a jackrabbit is found, the jackrabbit should be allowed to move out of harm's way.

**BIO-7:** A focused survey for burrowing owl should be conducted prior to commencement of construction activities, in compliance with the CDFW Staff Report on Burrowing Owl Mitigation (March 7, 2012). The surveys will determine the potential effects of the Proposed Project and activities on burrowing owls, and to avoid take in accordance with CDFW Code sections 86, 3503, and 3503.5. The assessment will determine how burrowing owls are utilizing the Project and surrounding area, where the owls are located, and the status of the owls (i.e., breeding, satellite burrows, etc.). Occupied (breeding) burrows must be avoided during the nesting period, from February 1 through August 31. Occupied burrows during the non-breeding season by migratory or non-migratory residents should also be avoided. Avoidance buffers will be based on the CDFW recommended restricted activity dates and setback distances outlined in the CDFW Staff Report. If non-breeding occupied burrows cannot be avoided, coordination with CDFW will be required to determine if passive relocation is possible. In this event, a Burrowing Owl Exclusion Plan that details a burrowing owl exclusion plan will be required and approved by CDFW before such activities are conducted. Biological monitoring of the owls (prior to, during and after exclusion) will be required in accordance with the CDFW Staff Report recommendations. Mitigation for permanent impacts to nesting, occupied and satellite burrows and associated burrowing owl habitat will be required in accordance with CDFW mitigation requirements. A Burrowing Owl Monitoring and Mitigation Plan, approved by CDFW, will be required prior to initiating ground disturbance activities.

**BIO-8:** Take avoidance surveys in accordance with the CDFW Burrowing Owl Staff Report (CDFW 2012) for burrowing owl will be required prior to commencement of construction activities. The survey must be completed no less than 14 days prior to initiating ground disturbance activities.

**BIO-9:** Biological monitoring of the burrowing owls will be required during Project construction activities to ensure no impacts to burrowing owl occur. The level of effort and duration of the monitoring will be provided in the Burrowing Owl Monitoring and Mitigation Plan.

Potentially Significant Impact (PSI)	Less Than Significant With Mitigation Incorporated (LTSWMI)	Less Than Significant Impact (LTSI)	No Impact (NI)
--------------------------------------	---	-------------------------------------	----------------

**Jurisdictional Waters**

The Study Area is located within the Salton Sea Watershed and Alamo River Watershed, within the USACE Hydrological Unit Code (HUC) 12: 181002040801 – Town of El Centro Sub-Watershed. This sub-watershed contains an area of approximately 158 square miles (CWIP 2022). Many agricultural drainages and canals within this sub-watershed connect to the Alamo River and flow northward towards the Salton Sea. The Alamo River originates approximately 2 miles south of the U.S. border with Mexico, flows northward across the border for approximately 50 miles until it terminates into the Salton Sea.

According to the NWI and NHD databases, two streams (agricultural drainages) exist within the northern and southern boundaries of the Study Area (Figure 3). The Dahlia Lateral 8 canal (ID-1) enters the Study Area from the southwest corner along Highway 86 and Lydick Loop, flowing east and northeast into the Newside Drain. Based on the preliminary designs, approximately 850 linear feet of a concrete lined agricultural ditch (Dahlia Lateral 8 canal) may be temporarily impacted in the southeast corner of the Study Area; portions the canal will be covered and left in place to support the proposed ladder tracks along the southeastern corner of the Study Area. This portion of the canal is concrete-lined (unvegetated) and does not provide suitable habitat for sensitive plant or wildlife species.

The second drainage, Newside Drain (ID-2) enters the northern area of the Study Area on the west side of Highway 86 from Lydick Loop and Highway 86 and directs flow east/northeast to the Newside Drain. A small outlet of approximately 33 linear feet from the proposed drainage basin into the Newside Drain is anticipated.

The Newside Drain continues off site and flows northeastward to the Rose Canal, east to the Rose Outlet, northeastward to the Alamo River, and northward to the Salton Sea. These drainages facilitate water around the site and eventually to the Salton Sea; therefore, these drainages may be considered WoUS subject to potential USACE jurisdiction under Section 404 of the Clean Water Act, waters of the State pursuant to Section 401 of the Clean Water Act and the California Porter-Cologne Water Quality Control Act (California Water Code, Division 7, §13000 et seq.), and subject to potential CDFW jurisdiction under Sections 1600 et seq. of the California Fish and Game Code.

The following mitigation measures are proposed that specifically relate to jurisdictional features located within the Proposed Project in general:

**BIO-10:** The construction footprint will be clearly defined with flagging and/or fencing to avoid impacts to jurisdictional waters and will be removed upon completion.

**BIO-11:** BMPs including erosion control measures, such as weed-free straw wattles should be in place during the construction near jurisdictional water areas to avoid downstream sedimentation.

**BIO-12:** Additional protection measures for the protection of jurisdictional waters and associated mitigation will be identified in the 401/404/1600 permits.

- a) Have a substantial adverse effect, either directly or through habitat modifications, on any species identified as a candidate, sensitive, or special status species in local or regional plans, policies or regulations, or by the California Department of Fish and Wildlife or U.S. Fish and Wildlife Service?

**a) Consistent with the MEIR; Less than Significant Impact with Mitigation.** As discussed in the MEIR, there is a potential for sensitive species to occur within the study area and the MEIR required Mitigation Measure 4.5.2, to evaluate rare plant species within areas of specific development prior to construction. As mentioned above, Chambers Group surveyed the Proposed Project site to evaluate the potential for sensitive species on site, and thus meet the requirements of Mitigation Measure 4.5.2. As mentioned above, while there is a potential for sensitive plant species to exist on site, none were observed during the survey. The only special status species identified within the study area was the Burrowing Owl (*Athene cunicularia*). At least sixteen burrowing owls and burrowing owl signs were observed in the southwest portion of the Study Area, along the edges of the concrete-lined irrigation canal (Dahlia Lateral 8). Based on the preliminary design, no impacts to this portion of the canal are anticipated (temporary impacts to Dahlia Lateral 8 are proposed in the southeast corner of the Study Area).

The Project would be required to implement Mitigation Measure **BIO-2**, which would require worker awareness training prior to construction so sensitive species can be spotted by on-site employees.

Additionally, the MEIR included mitigation measures to protect these species; however, since protocols and requirements have changed since the time of adoption of the MEIR, those mitigation measures have been replaced with similar, new mitigation measures. In lieu of MEIR Mitigation Measure 4.5.4, the Project would be required to implement Mitigation Measures **BIO-3**, **BIO-4**, and **BIO-7** through **BIO-9**, which would require protection for Burrowing Owls. In lieu of MEIR Mitigation Measure 4.5.5, the Project would be required to implement Mitigation Measure **BIO-5**, which would protect migratory birds during nesting and breeding seasons. With implementation of Mitigation Measures **BIO-1** through **BIO-9**, impacts would be less than significant.

Potentially Significant Impact (PSI)	Less Than Significant With Mitigation Incorporated (LTSWMI)	Less Than Significant Impact (LTSI)	No Impact (NI)
--------------------------------------	---	-------------------------------------	----------------

- b) Have a substantial adverse effect on any riparian habitat or other sensitive natural community identified in local or regional plans, policies, regulations, or by the California Department of Fish and Wildlife or U.S. Fish and Wildlife Service?

**b) Consistent with the MEIR; Less than Significant Impact with Mitigation.** As discussed in the MEIR, portions of the SPA were found to be considered jurisdictional waters and the MEIR required Mitigation Measure 4.5.1 to evaluate if wetlands or waters would be impacted with implementation of projects in the SPA. As mentioned above, Chambers Group surveyed the Proposed Project site to confirm the hydrology and hydrologic connectivity of the area, and thus meet the requirements of Mitigation Measure 4.5.1. Approximately 0.04 acres of permanent and 0.01 acres of temporary impacts of non-wetland waters (concrete-lined canal) of the State within the overall Study Area that are subject to the potential regulatory authority of the RWQCB jurisdiction are regulated under Section 401 of the Clean Water Act. Under Section 401 of the CWA, the RWQCB regulates any activity that requires a federal permit for discharges to a water body. The State Water Board General Order (Order No. WQ 2021-0048-DWQ) is pre-certified for USACE NWP 14 but requires the project to be exempt from CEQA and comply with the size threshold of no more than 0.01 acre and 100 linear feet permanent impact and no more than 0.2 acre and 300 linear feet total impact. This Project does not meet the requirements for the General Order. A 401 Water Quality Certification may be required from the RWQCB for this Project.

Approximately 0.13 acre of permanent and 0.05 acre of temporary impacts to the concrete-lined canals are subject to potential CDFW jurisdiction under Sections 1600 et seq. of the California Fish and Game Code. CDFW regulates impacts or alterations to streambeds, including any obstruction or diversion to the natural flow of a stream, substantial change or use of material from a stream, or a deposit or disposal of any debris into a stream as part of Fish and Game Code Sections 1600-02. A Streambed Alteration Agreement (SAA) may be required from CDFW for this Project.

As the Project may be subject to potential USACE jurisdiction under Section 404 of the Clean Water Act, waters of the State pursuant to Section 401 of the Clean Water Act and the California Porter-Cologne Water Quality Control Act (California Water Code, Division 7, §13000 et seq.), and subject to potential CDFW jurisdiction under Sections 1600 et seq. of the California Fish and Game Code, mitigation measures BIO-10 through BIO-12 would be implemented.

With the installation of the proposed water detention basin and conversion of open canal to closed canal, no net loss of waters is anticipated for this Project. No native vegetation is associated with the concrete-lined canals; therefore, no restoration of native habitat is proposed. Any temporary impacts to concrete-lined portions of the canal will be restored to its original condition. Therefore, implementation of the Project would not result in any new impacts that were not previously analyzed and would be consistent with the MEIR. Impacts would be less than significant with implementation of Bio-10 through BIO-12.

- c) Have a substantial adverse effect on state or federally protected wetlands (including, but not limited to, marsh, vernal pool, coastal, etc.) through direct removal, filling, hydrological interruption, or other means?

**c) Consistent with the MEIR; Less than Significant Impact.** Three vegetation communities identified within the Study Area have vegetation that can be found in wetland communities including Bush Seepweed Scrub, Tamarisk Thickets, and Arrow Weed Thickets. Five soil pits were dug in the areas mapped as Bush Seepweed Scrub (Figure 5). Two of the soil pits were investigated between the cemetery and the agricultural fields, while three soil pits were investigated north of the central agricultural field in locations where seepage from the non-jurisdictional agricultural ditches had been observed on historical aerial imagery. The entire area where Bush Seepweed Scrub was found looked to have been regularly tilled. Soils within the first six inches of the soil profile (for all soil pits) were identified as friable sandy clay soils with a color of 7.5YR 4/2 (Munsell 2015). The lower sections in the soil profile were very compact, clay loam soils with a color of 7.5YR 6/2 (Munsell 2015). No redoximorphic features were observed in any of the soil pits; thus, no hydric soils exist within the Bush Seepweed Scrub and are therefore not considered a wetland community.

Additional test pits were dug in areas where Arrow Weed Thickets and Tamarisk Thickets were identified. These communities were primarily found in the southeast corner and the northwest area of the Study Area. The same soil profiles with no redoximorphic features were identified in these communities.

The agricultural areas within the Study Area are proposed to be developed; therefore, the agricultural ditches used to support the area will no longer be in use and will not support Arrow Weed Thickets or Tamarisk Thickets. No hydric soils were identified in these communities; therefore, Arrow Weed Thickets and Tamarisk Thickets are not considered wetland communities. Based on the results of the database analysis and field delineation survey, no wetlands exist within the Study Area and impacts would be less than significant.

- d) Interfere substantially with the movement of any resident or migratory fish or wildlife species or with established native resident or migratory wildlife corridors, or impede the use of



Potentially Significant Impact (PSI)	Less Than Significant With Mitigation Incorporated (LTSWMI)	Less Than Significant Impact (LTSI)	No Impact (NI)
--------------------------------------	---	-------------------------------------	----------------

native wildlife nursery sites?

**d) Consistent with the MEIR; Less than Significant with Mitigation.** As discussed in the MEIR, the SPA is part of a major contiguous wildlife corridor in the County. Development within the SPA was found to have no indirect or direct impacts because the SPA is surrounded by large amounts of similar habitat and linkages that would be available for wildlife movement; thus, development of the SPA would not result in removing significant acres of migration corridors. However, the potential for migratory birds to utilize the site still exists. As mentioned above, the Project would be required to implement Mitigation Measure **BIO-2** which would require worker awareness training prior to construction so sensitive species can be spotted by on-site employees. In addition, the Project would be required to implement Mitigation Measure **BIO-5**, which would protect migratory birds during nesting and breeding seasons. Similar to the MEIR, the implementation of Mitigation Measures **BIO-2** and **BIO-6**, impacts would be less than significant.

- e) Conflict with any local policies or ordinance protecting biological resource, such as a tree preservation policy or ordinance?

**e) Consistent with the MEIR; Less than Significant Impact.** The County's Land Use Ordinance Section 90302.03 outlines the requirements for landscaping within industrial uses. The Proposed Project's grading activities would remove the existing vegetation. However, as discussed in the Biological Reconnaissance Assessment, the Project would not result in significant impacts to sensitive habitats and would be required to follow the requirements in the County's Land Use Ordinance. Implementation of the Project would not result in any new impacts that were not previously analyzed and would be consistent with the MEIR. Impacts would be less than significant.

- f) Conflict with the provisions of an adopted Habitat Conservation Plan, Natural Community Conservation Plan, or other approved local, regional, or state habitat conservation plan?

**f) Consistent with the MEIR; Less than Significant Impact.** As discussed in the Biological Reconnaissance Assessment, the Proposed Project lies outside the scope of the IID Habitat Conservation Plan. Based on the results of the survey, it was found that the Proposed Project would not result in significant impacts to habitats and would have no impacts to wetlands based on the vegetation and soils present at the Proposed Project site. Furthermore, the area currently is zoned for industrial use and is not designated to be part of any local, regional, or State conservation plan. Implementation of the Proposed Project would not result in any new impacts that were not previously analyzed and would be consistent with the MEI. Impacts would be less than significant.

**V CULTURAL RESOURCES Would the project:**

- a) Cause a substantial adverse change in the significance of a historical resource pursuant to §15064.5?
- b) Cause a substantial adverse change in the significance of an archaeological resource pursuant to §15064.5?
- c) Disturb any human remains, including those interred outside of dedicated cemeteries?

**Summary of Impacts Identified in the MEIR:**

The existing MEIR evaluated historical and archaeological impacts associated with development of the Mesquite Specific Plan. The MEIR noted that Imperial Valley's agricultural and water resource development beginning in the late 1800s also represents important historic elements. However, in the study area, surviving structures or sites reflecting Imperial County historical development are not likely to be found. The nearest documented historic resource is the Imperial Cemetery located south of the study area approximately three-quarters of a mile. There are also roads, canals, drains, powerlines, and the Niland to Calexico rail line that are old enough (50 years or older) and perhaps important enough in the development of Imperial County to be considered significant historic resources for planning purposes. Most of these appear to have been constantly modified, maintained, and improved over the years so that little of the original historic fabric is left. There may be roads, canals, drains, powerlines, and the Niland to Calexico rail line that are old enough to be considered historic resources. The significance of these potential historic features would have to be evaluated on a case-by-case basis.

Further, the MEIR noted that Development within the Mesquite Lake Specific Plan would have the potential to impact Late Prehistoric archaeological materials in areas associated with lower elevation recessional shorelines of Lake Cahuilla. These potential resources sites are most likely to occur in the southwestern portion of the study area between elevation -75 feet at the corner of Harris Road and SR 86 and elevation -100 feet just west of the Rose Canal in the western part of the study area. Areas where intensive cultivation for agriculture use has occurred would have a low probability for the presence of significant cultural resource due to deep excavation for drainage tiles and recurring surface disturbance. Pre-construction surveys of existing cultivated areas would also have a low probability of discovery of cultural resources. However, cultural resources could be uncovered during site clearing, grading, or construction, in which case site development should be halted and a qualified archaeologist should be consulted.

The MEIR concluded that with implementation of Mitigation Measure 4.6.1 and 4.6.2, impacts would be less than significant.

Potentially Significant Impact (PSI)	Less Than Significant Mitigation Incorporated (LTSWMI)	Less Than Significant Impact (LTSI)	No Impact (NI)
--------------------------------------	--	-------------------------------------	----------------

**Mitigation Measure 4.6.1** No pre-construction archaeological surveys shall be required in areas previously developed. However, if during grading or construction, evidence of potential archaeological resources is encountered, grading and construction shall be halted, the [South Coastal Information Center (located at California State University, San Diego)] and the County Planning and Development Services Director shall be notified, and a qualified archaeologist shall be contracted by the developer to inspect the site. Resumption of grading or construction shall not be commenced until the archaeologist has advised the Planning and Development Services Director regarding the potential for cultural resources at the site and the Planning and Development Services Director notifies the developer that grading, or construction may proceed. If further archaeological investigation is required by the Planning and Development Services Director, the procedures in Mitigation Measure 4.6.2 shall be followed.

**Mitigation Measure 4.6.2** Prior to approval of a CUP, tentative map, site plan, grading plan, or building permit for any phase or unit of development on lands not previously disturbed by agricultural use that are within the portion of the Specific Plan shown as the Cultural Resource Survey Area in Figure 4-5, field surveys shall be conducted to determine the presence/absence of archaeological resources and a report of the surveys provided to the Planning and Development Services Director. A testing program shall be approved by the Planning and Development Services Director for any identified resources to determine their significance and proper mitigation. Mitigation may include preservation in place, documentation, including recordation of findings at the Southeastern Information Center (located at the Imperial Valley College Desert Museum), and curation of materials at an appropriate local facility for long-term preservation and study. If a testing and/or excavation program is required, local Native American groups shall be notified, and a Native American monitor shall be present during excavation.

**Impacts Related to the Proposed Project:**

- |   |                          |                                     |                          |                          |
|---|--------------------------|-------------------------------------|--------------------------|--------------------------|
| a) Cause a substantial adverse change in the significance of a historical resource pursuant to §15064.5?      | <input type="checkbox"/> | <input checked="" type="checkbox"/> | <input type="checkbox"/> | <input type="checkbox"/> |
| b) Cause a substantial adverse change in the significance of an archaeological resource pursuant to §15064.5? | <input type="checkbox"/> | <input checked="" type="checkbox"/> | <input type="checkbox"/> | <input type="checkbox"/> |

**a) and b) Consistent with the MEIR, Less than Significant with Mitigation.** Chambers Group conducted a site visit on September 16, 2022, in accordance with the MEIR Mitigation Measures 4.6.1 and 4.6.2 (Appendix C). Additionally, Chambers Group requested a Sacred Lands File (SLF) records search from the Native American Heritage Commission (NAHC). The purpose of the request is to determine if any sacred lands or other resources have been recorded within the Project site or adjacent areas. The results of the SLF search, provided by the NAHC on October 18, 2022, were positive.

MEIR Mitigation Measure 4.6.1 stipulates, "no pre-construction archaeological surveys shall be required in areas of existing agricultural or other substantial development." The Project site contains existing agricultural operations, including approximately 120 acres of recently harvested wheat that is planted and harvested as a rotation crop between other crops. The Project site also has vacant areas that have previously been farmed and the existing Memory Gardens Cemetery. Upon initial review of the Project site and publicly available historic maps and both historic and current aerial imagery, Chambers Group observed that there is evidence of current and previous agricultural activity within all open space outside currently developed areas in the Project site. Specifically, Chambers Group observed evidence of previous agricultural land use in aerial photographs dating to 1953, 1976, and 1984 (NETR 2022, UCSB 1976). In the effort to further, confirm the historic land use within the portions of the site not currently utilized for agricultural purposes or developed with built environment, the Imperial County Agricultural Commission (Ag. Commission), the Imperial Irrigation District (IID), and the County Surveyor (Surveyor) were contacted to review their records. IID did not have records dating back that far, the Ag. Commission did not have a history of farming on the sites; however, the Surveyor was able to provide photographic evidence of farming occurring historically on all sites not actively being farmed. Finally, in the effort to further verify the current conditions of the Project site, Chambers Group visited the Project site to confirm that this condition was met. During the site visit, Chambers Group observed that the overall condition of the Project site was largely unchanged from the conditions cited in the MEIR. Evidence of historic agricultural activity was observed in areas not currently utilized for agriculture and not previously developed with built environment.

Chambers Group concluded that while surface manifestations of cultural resources were not observed during the previous cultural resources study in support of the MEIR, and the current site visit, it should be noted that the landscape has been under historic-period use and settlement. This historic utilization may have resulted in unrecognized buried features such as footings and foundations or refuse area such as trash pits or outhouses. Similarly, ethnographic data and historic-period maps indicate that Native American groups such as the Kamia occupied and utilized major and minor drainages within the Salton Basin, as is documented on the 1856 General Land Office map, which depicted an "Indian Village" in the northeast quarter of Section 36 (Township 14S, Range 14E). The understanding that the area is important to Native American groups is further supported by the positive NAHC SLF records search results. However, the Project would implement MEIR Mitigation Measures 4.6.1 and 4.6.2, the former of which notes that if any unanticipated discovery of potential cultural resources are encountered during the Project, that proper protocols would be implemented.

Additionally, as previously mentioned, the MEIR noted that there are roads, canals, drains, powerlines, and the Niland to Calexico rail line that are old enough (50 years or older) and perhaps important enough in the development of Imperial County to be considered significant historic resources for planning purposes, that would need to be evaluated on a case by case basis. While canals and railway surround the Project site, the Proposed Project would not impact either of these resources. Therefore, with implementation of MEIR

	Potentially Significant Impact (PSI)	Less Than Significant With Mitigation Incorporated (LTSWMI)	Less Than Significant Impact (LTSI)	No Impact (NI)
--	--------------------------------------	---	-------------------------------------	----------------

Mitigation Measures 4.6.1 and 4.6.2, impacts to cultural resources would be consistent with the MEIR and impacts would be less than significant.

- c) Disturb any human remains, including those interred outside of dedicated cemeteries?

**c) Consistent with the MEIR, Less than Significant Impact.** As discussed in Thresholds (a) and (b) above, it is unlikely that any resources would be found onsite. However, in the unlikely event that human remains are discovered during ground-disturbing activities, then the Proposed Project would be subject to California Health and Safety Code 7050.5, CEQA Section 15064.5, and California Public Resources Code Section 5097.98. If human remains are found during ground-disturbing activities, State of California Health and Safety Code Section 7050.5 states that no further disturbance shall occur until the Ventura County Coroner has made a determination of origin and disposition pursuant to Public Resources Code Section 5097.98. In the event of an unanticipated discovery of human remains, the County Coroner shall be notified immediately. If the human remains are determined to be prehistoric, the County Coroner shall notify the NAHC, which shall notify a most likely descendant (MLD). The MLD shall complete the inspection of the site within 48 hours of notification and may recommend scientific removal and nondestructive analysis of human remains and items associated with Native American burials. Therefore, consistent with the MEIR, a less than significant impact would occur.

**VI ENERGY Would the project:**

- a) Result in potentially significant environmental impact due to wasteful, inefficient, or unnecessary consumption of energy resources, during project construction or operation?
- b) Conflict with or obstruct a state or local plan for renewable energy or energy efficiency?

**Summary of Impacts Identified in the MEIR:**

In 2018, the Office of Planning and Research updated the CEQA Guidelines to include Energy as a resource area to the Appendix G checklist. The section aimed to evaluate project energy usage during both construction and operation to ensure wasteful or inefficient energy usage was being properly evaluated. During the preparation of the MEIR, energy impacts were not part of the analysis, as it was not a resource area required for discussion. The only mention of energy usage was in regards to building standards, which are in the Specific Plan and include recommendations for sustainable building design that is efficient in its use of natural resources for building construction and maintenance and also promotes use of the LEED (Leadership in Energy and Environmental Design) Green Building Rating System,™ developed by the U.S. Green Building Council.

**Impacts Related to the Proposed Project:**

- a) Result in potentially significant environmental impact due to wasteful, inefficient, or unnecessary consumption of energy resources, during project construction or operation?

**a) Consistent with the MEIR, Less than Significant Impact.** The Proposed Project would allow for the development and operation of three (3) rail loop tracks totaling approximately 33,000 track feet, a rail ladder track totaling approximately 25,000 track feet, and an approximately 2,000 track feet spur that will tie into the adjacent Union Pacific Railroad Right of Way (ROW).

The rail system will facilitate inbound and outbound trains containing commodities as well as the transloading of commodities to and from trucks. Also included in the Proposed Project is a grain elevator; shipping container depot, a fuel blending/transloading area; a fueling station, warehousing, and a veteran's memorial area adjacent to the existing cemetery. The Project would also provide an extension to the SoCal Gas line from Keystone Road approximately 1.3 miles along State Route 86 to the Project Site.

Additionally, the Proposed Project seeks a specific plan amendment and zone change from Light and Medium Industrial to Heavy Industrial.

Based on the air quality modeling, the project would on average consume, 469 thousand British Thermal Units (kBtu) of natural Gas and 1,036,422 kilowatt hours (kWh) of electricity each year. Under that analysis, reductions from T24 (2019) were accounted for which would improve the efficiency of the project in terms of energy consumption.

Potentially Significant Impact (PSI)	Less Than Significant With Mitigation Incorporated (LTSWMI)	Less Than Significant Impact (LTSI)	No Impact (NI)
--------------------------------------	---	-------------------------------------	----------------

Construction emissions from workers vendors and hauling are based on the estimated vehicle miles traveled (VMT) for the total construction duration which is 1,921,345 miles total. In California, the average fuel intensity for on-road vehicles is 0.0615 gal/mile (University of California, Irvine, 2005). Based on this, vehicular trips would consume roughly 118,163 gallons total during construction.

The long-term energy demand during operations of the project would not result in a wasteful or inefficient use of energy since the Proposed Project would largely shift the transport of goods from Long Beach and Los Angeles to Imperial County and from trucks to rail which is known to reduce the demand on fuel by as much as 4 times (Union Pacific, 2022). Given this, the Proposed Project would not result in a wasteful or inefficient use of energy and a less than significant impact is expected.

- b) Conflict with or obstruct a state or local plan for renewable energy or energy efficiency?

**b) Consistent with the MEIR, No Impact.** The purpose of the Proposed Project is to construct and operate of three (3) rail loop tracks totaling approximately 33,000 track feet, including a rail ladder track totaling approximately 25,000 track feet, and an approximately 2,000 track feet of spur that tie into the adjacent Union Pacific Railroad ROW ('rail system'). The rail system will facilitate inbound and outbound trains of commodities as well as the transloading of commodities to and from trucks. Also included in the Project are a grain elevator; shipping container depot, including but not limited to the function of hay/grain export; a veterans memorial area adjacent to the existing cemetery; a fuel blending / transloading area; a fueling station, including but not limited to Compressed Natural Gas (CNG, methane); and areas for transloading and storage of commodities.

Senate Bill 350, Senate Bill 100, and the California Global Warming Solutions Act (Assembly Bill 32) and greenhouse gas emissions reduction objectives in Imperial County. Once in operation, it will decrease the need for energy from fossil fuel-based power plants in the state and would help offset GHG emissions. Additionally, the Proposed Project would also be consistent with the County's General Plan Conservation and Open Space Element, Objective 9.2. The proposed Project would not conflict with or obstruct a state or local plan for energy efficiency; therefore, no impact would occur.

**VII GEOLOGY AND SOILS Would the project:**

- a) Directly or indirectly cause potential substantial adverse effects, including risk of loss, injury, or death involving:
- 1) Rupture of a known earthquake fault, as delineated on the most recent Alquist-Priolo Earthquake Fault Zoning Map issued by the State Geologist for the area or based on other substantial evidence of a known fault? Refer to Division of Mines and Geology Special Publication 42?
  - 2) Strong Seismic ground shaking?
  - 3) Seismic-related ground failure, including liquefaction and seiche/tsunami?
  - 4) Landslides?
- b) Result in substantial soil erosion or the loss of topsoil?
- c) Be located on a geologic unit or soil that is unstable or that would become unstable as a result of the project, and potentially result in on- or off-site landslides, lateral spreading, subsidence, liquefaction or collapse?
- d) Be located on expansive soil, as defined in the latest Uniform Building Code, creating substantial direct or indirect risk to life or property?
- e) Have soils incapable of adequately supporting the use of septic tanks or alternative waste water disposal systems where sewers are not available for the disposal of waste water?
- f) Directly or indirectly destroy a unique paleontological resource or site or unique geologic feature?



Potentially Significant Impact (PSI)	Less Than Significant With Mitigation Incorporated (LTSWMI)	Less Than Significant Impact (LTSI)	No Impact (NI)
--------------------------------------	---	-------------------------------------	----------------

**Summary of Impacts Identified in the MEIR:**

While Geology and Soils were not a separate environmental category under CEQA in 2006, potential impacts due to geological hazards were evaluated under the Hazards and Hazardous Materials Section of the MEIR. The MEIR notes that the specific plan area contains geologic features that must be considered during site planning and development. The Imperial Fault passes through Mesquite Lake, generally on a north-south alignment. In accordance with the Alquist-Priolo Earthquake Fault Zoning Act (Chapter 7.5 of Division 2, California Public Resources Code), the Office of State Geologist has delineated Special Study Zones, which encompass potentially and recently active traces of major faults. MEIR Figure 2-2 shows the location of the Special Study Zone within Mesquite Lake. Division 15 of the County Land Use Ordinance includes procedures for review of structures intended for human occupancy that are located within a special study zone. These procedures require preparation of a geologic report by a State-registered geologist. In most cases, a minimum setback of 50 feet from the trace of a fault would be required and, in all cases of a proposed human-occupied structure to be located within a special study zone, a determination must be made and supported by the geologic report that no undue hazard would be created by the proposed structure.

Compliance with Division 17 of the County Land Use Ordinance would ensure that all project structures intended for human occupancy that are proposed to be located within the special studies zone shown in MEIR Figure 2-2 would require preparation of a geologic report and a determination that no undue hazard would be created by the proposed structure.

While the MEIR did not explicitly discuss impacts associated with septic systems, septic systems were noted as being a possibility with build out of the Specific Plan and MEIR MM 4.2.3 as described in Section X Hydrology and Water Quality, would require material and waste management programs for septic systems to address proper secondary containment requirements.

Liquefaction, seiches, tsunamis, and landslides, were not previously discussed in the MEIR. However, all other impacts related to geology and soils were considered to be less than significant with compliance to existing regulations.

As previously discussed in Section V Cultural Resources, the MEIR concluded that with implementation of Mitigation Measure 4.6.1 and 4.6.2, impacts to paleontological resources would be less than significant.

**Impacts Related to the Proposed Project:**

a) Directly or indirectly cause potential substantial adverse effects, including risk of loss, injury, or death involving:

- |  |                          |                          |                                     |                          |
|--|--------------------------|--------------------------|-------------------------------------|--------------------------|
| 1) Rupture of a known earthquake fault, as delineated on the most recent Alquist-Priolo Earthquake Fault Zoning Map issued by the State Geologist for the area or based on other substantial evidence of a known fault? Refer to Division of Mines and Geology Special Publication 42? | <input type="checkbox"/> | <input type="checkbox"/> | <input checked="" type="checkbox"/> | <input type="checkbox"/> |
| 2) Strong Seismic ground shaking?  | <input type="checkbox"/> | <input type="checkbox"/> | <input checked="" type="checkbox"/> | <input type="checkbox"/> |

**1) and 2) Consistent with the MEIR, Less than Significant.** The Imperial Fault, which is an Alquist-Priolo designated fault, passes through the Specific Plan area, generally on a north-south alignment, however the fault and fault hazard study zone, do not overlap with the Project site (DOC 2022c). Additionally, the Proposed Project is not located on or near the fault zone as shown in the MEIR Figure 2-2, which means that a geologic study is not required. No other faults or fault hazard zones are located near the Project site. Nonetheless, similar to all of California, Imperial County is a seismically active area and could result in strong seismic ground shaking. To lessen potential hazards related to seismic ground shaking, Project structures would be analyzed for earthquake loading during design, and would be designed in accordance with the 2022 seismic requirements provided in the California Building Code. Compliance with the 2022 CBC would ensure that impacts due to seismic hazards would remain less than significant.

- |   |                          |                          |                                     |                          |
|---|--------------------------|--------------------------|-------------------------------------|--------------------------|
| 3) Seismic-related ground failure, including liquefaction and seiche/tsunami? | <input type="checkbox"/> | <input type="checkbox"/> | <input checked="" type="checkbox"/> | <input type="checkbox"/> |
|---|--------------------------|--------------------------|-------------------------------------|--------------------------|

**3) Less than Significant Impact.** The Proposed Project is not located near an ocean or large body of water and would not result in any seiche or tsunami. Additionally, the Project site is not located in a liquefaction zone (DOC 2022c). Nonetheless, the Project would be designed in accordance with the 2022 CBC, which would ensure that impacts associated with seismic-related ground failures would be less than significant.

- |                |                          |                          |                          |                                     |
|----------------|--------------------------|--------------------------|--------------------------|-------------------------------------|
| 4) Landslides? | <input type="checkbox"/> | <input type="checkbox"/> | <input type="checkbox"/> | <input checked="" type="checkbox"/> |
|----------------|--------------------------|--------------------------|--------------------------|-------------------------------------|

**4) No Impact.** The Proposed Project is located in the Imperial Valley and the area surrounding the site is relatively flat with no chance for seismic induced landslides (DOC 2022c). According to the County General Plan, the closest area of landslide activity is on the border of San Diego and Imperial Counties approximately 30 miles west of the Project site (County 1993b). The Project would not exacerbate the risk of loss, injury, or death involving landslides. No impacts would occur and no further analysis is required.

	Potentially Significant Impact (PSI)	Less Than Significant With Mitigation Incorporated (LTSWMI)	Less Than Significant Impact (LTSI)	No Impact (NI)
--	--------------------------------------	---	-------------------------------------	----------------

- b) Result in substantial soil erosion or the loss of topsoil?      
**b) Consistent with the MEIR, Less Than Significant with Mitigation.** Project construction and operations have the potential to result in soil erosion and loss of topsoil mainly through grading. The site preparation will include an estimated 150,000 cubic yards of cut and 150,000 cubic yards of fill; soil will be balanced on site. Other material imports would include an import of approximately 140,000 cubic yards of granular select fill for use underneath concrete building pads, an import of approximately 161,000 tons of ballast and 48,000 tons of sub-ballast for the three (3) loop tracks (approximately 33,000 track feet in total), ladder track (approximately 25,000 track feet) and approximately 2,000 track feet of additional spur. Compliance with Specific Plan Mitigation Measure 4.2.3, Construction Stormwater Pollution Prevention Plan, as described in Section X Hydrology and Water Quality, would require that a Stormwater Pollution Prevention Plan (SWPPP) be prepared for the Project. The SWPPP would include erosion and sediment control measures, Best Management Practices (BMPs) and would require that all erosion and sediment control measures be inspected and maintained for proper integrity. Compliance with the MEIR mitigation, would ensure impacts would remain less than significant.
- c) Be located on a geologic unit or soil that is unstable or that would become unstable as a result of the project, and potentially result in on- or off-site landslides, lateral spreading, subsidence, liquefaction or collapse?
- d) Be located on expansive soil, as defined in the latest Uniform Building Code, creating substantial direct or indirect risk to life or property?      
**c) and d) Consistent with the MEIR, Less than Significant Impact.** As previously discussed, the Project site is flat and is not located within a Department of Conservation identified liquefaction or landslide zone (DOC 2022c). However, the County General Plan identifies that liquefaction is a common hazard in the County (County 1993b). Soils on the Project site are also majority wet Imperial silty clay and Imperial-Glenbar silt clay loams, which may be susceptible to soil instabilities causing subsidence, liquefaction, and expansion (USDA 2022). However, the Project would be required to adhere to the 2022 CBC which would ensure that impacts due to unstable or expansive soil would remain less than significant.
- e) Have soils incapable of adequately supporting the use of septic tanks or alternative waste water disposal systems where sewers are not available for the disposal of waste water?      
**e) Consistent with the MEIR, Less than Significant with Mitigation.** The Project will include septic systems with leach fields for the different elements of the logistics center, which would result in up to nine separate septic systems. The septic systems and leach fields would be required to be constructed with State and County standards. Additionally, compliance with Specific Plan Mitigation Measure 4.2.3, Construction Stormwater Pollution Prevention Plan, as described in Section X Hydrology and Water Quality, would require material and waste management programs for septic systems to address proper secondary containment requirements. Compliance with regulatory measures and MEIR mitigation, impacts would remain less than significant.
- f) Directly or indirectly destroy a unique paleontological resource or site or unique geologic feature?      
**f) Consistent with the MEIR, Less than Significant with Mitigation.** As previously mentioned under Section V Cultural Resources, Chambers Group conducted a site visit of the Project site and concluded that while surface manifestations of cultural resources, including paleontological resources, were not observed during the previous cultural resources study in support of the MEIR, and the current site visit, it should be noted that the landscape has been under historic-period use and settlement. This historic utilization may have resulted in unrecognized buried features such as footings and foundations or refuse area such as trash pits or outhouses. Similarly, ethnographic data and historic-period maps indicate that Native American groups such as the Karmia occupied and utilized major and minor drainages within the Salton Basin, as is documented on the 1856 General Land Office map, which depicted an "Indian Village" in the northeast quarter of Section 36 (Township 14S, Range 14E). The understanding that the area is important to Native American groups is further supported by the positive NAHC SLF records search results. However, the Project would implement MEIR Mitigation Measures 4.6.1 and 4.6.2, the former of which notes that if any unanticipated discovery of potential cultural resources are encountered during the Project, that proper protocols would be implemented. Therefore, consistent with the MEIR, with implementation of Mitigation Measures 4.6.1 and 4.6.2, impacts would be less than significant.

**VIII GREENHOUSE GAS EMISSION Would the project:**

- a) Generate greenhouse gas emissions, either directly or indirectly, that may have a significant impact on the environment?
- b) Conflict with an applicable plan or policy or regulation adopted for the purpose of reducing the emissions of greenhouse

Potentially Significant Impact (PSI)	Less Than Significant With Mitigation Incorporated (LTSWMI)	Less Than Significant Impact (LTSI)	No Impact (NI)
--------------------------------------	---	-------------------------------------	----------------

gases?

**Summary of Impacts Identified in the MEIR:**

In 2010, the Office of Planning and Research updated the CEQA Guidelines to include Greenhouse Gas Emissions (GHGs) as a resource area to the Appendix G checklist. The section aimed to evaluate project GHG generation during both construction and operation. In 2018, the guidelines were updated again to include further provisions on how to evaluate GHG impacts. These provisions touched on both climate change mitigation and adaptation, providing more detailed guidance on topics such as assessing the significance of GHG emissions, analyzing energy impacts and efficiency, estimating vehicle emissions, and evaluating environmental risks in light of a changing and uncertain baseline. During the preparation of the MEIR, GHG impacts were not part of the analysis as it was not a resource area required for discussion.

**Impacts Related to the Proposed Project:**

**Project Construction**

Construction of the Project is expected to begin sometime in 2024 and would continue for approximately 18 months if the site is built-out under a single construction effort. Site preparation is anticipated to take approximately 2 months, grading to take approximately 2 months, and vertical construction to occur over approximately 14 months. Project build-out is expected in 2025. It should be noted depending on market demands, the Project construction may occur incrementally over time though analysis under a single effort is considered the worst case.

Site preparation will include clearing and grubbing which would require export to the local recycling area. The land development includes grading to create rough graded streets, native soil preparatory work for track facilities, and pads for new construction. The site preparation will include an estimated 150,000 cubic yards (CY) of cut and 150,000 CY of fill; soil will be balanced on site.

The Project would require material imports which would include 140,000 CY of granular select fill for use underneath concrete building pads, an import of approximately 315,000 tons of ballast or 410,000 CY of material to construct the three (3) loop tracks and 28,000 tons or 32,000 CY of road base for the Industrial Street roadway, which will be surface finished with asphalt concrete. In all, the Project would import 582,000 CY of material and export roughly 1,000 CY of grubbed material. A concrete and rebar bridge/over-pass or a culvert/under-pass may ultimately be built to take trucks to and from the inside of the loop tracks. Prior to the full loop tracks being constructed, a private roadway will be constructed for access to the central part of the Project.

Table 4 shows the expected durations and construction equipment necessary to fully construct all the project infrastructure, structures, and rail lines. Additionally, the project would implement several design features which are identified on the following page. These design features were assumed within all modeling and therefore would be required and considered a condition to this Project's approval.

GHG impacts related to construction and daily operations were calculated using the latest CalEEMod 2020.4.0 air quality model, which was developed by BREEZE Software for South Coast Air Quality Management District (SCAQMD) in 2017.

**Project Related Construction Emissions**

Construction of the Project is expected to begin sometime in 2024 and would continue for approximately 18 months if the site is built under a single construction effort. Utilizing the CalEEMod inputs for the model as discussed above, grading and construction of the Proposed Project will produce approximately a maximum of 1,599.06 MT of CO<sub>2e</sub> within the first year of construction. Based on SQAQMD methodology, the Proposed Project would not exceed the 10,000 MT screening threshold for CO<sub>2e</sub> during any of the expected construction years. Based on this, a less than significant GHG impact would be expected from Construction. The emissions summary from CalEEMod is provided in Table 8 below.

**Table 8: Proposed Project Construction CO<sub>2e</sub> Emissions Summary MT/Year**

Year	Bio-CO2	NBio-CO2	Total CO2	CH4	N2O	CO2e
2024	0.00	1,556.79	1,556.79	0.17	0.13	1,599.06
2025	0.00	819.68	819.68	0.06	0.07	843.48

**Project Operations**

Routine operations and maintenance of the facility will include preventative maintenance and repairs of any damaged or otherwise inoperable equipment on an as-needed basis. The operation and maintenance staff will monitor the facility operations over the Project life to ensure that the logistics center is operating to meet design standards. Approximately 56 full-time employees are expected each day of the week during Project operations, with approximately two shifts per day (5am to 1pm and 11am to 7pm). The Project elements will be developed in accordance with Mesquite Lake Specific Plan and County development standards.

Potentially Significant Impact (PSI)	Less Than Significant With Mitigation Incorporated (LTSWMI)	Less Than Significant Impact (LTSI)	No Impact (NI)
--------------------------------------	---	-------------------------------------	----------------

Based on the projected traffic volumes estimated by the Project Traffic Engineer, the proposed project would generate approximately 107 regular employee ADT and as many as 436 ADT from heavy trucks (LL&G, 2023). As noted by the Project traffic engineer, the Green Valley Logistics Project would reduce regional vehicle miles travelled since the Logistics Center essentially would allow for train containers to bulk transfer goods between the Los Angeles Area to Imperial County, which are currently being carried via trucks mostly. The regional truck mileage associated with the Project site would essentially drop regional trips by more than a factor of 2/3 or 25 miles vs 80 miles previously. Since each truck using the Green Valley Logistics center would reduce miles traveled within the County of Imperial, only the employee trips were modeled within CalEEMod and no credit for the regional truck reductions was taken or calculated.

The Project area is currently being used for agricultural purposes and the site currently uses 630 acre-feet of water each year based on an average use factor of 5.25 acre-feet per acre (AFY). Based on delivery records from IID from 2013 thru 2022 the site has historically used an annual average of 1,708 AFY for agricultural and landscaping purposes. The Project would reduce water consumption by 1,528 acre-feet per year and would use 180 acre-feet annually at buildout. The Project model assumes 180 acre-feet of water usage annually by the Project and no credit for the 1,528 acre-feet was taken in this analysis.

The primary use of the site would enable goods to be shipped from the Los Angeles area into the County of Imperial in bulk via trains as opposed to via trucks, which are currently being used. This effort would require as many as two trains daily. Each train was assumed to have two locomotives each and would have as many as 60 rail cars on each train.

Locomotive emissions within the Project site were not modeled within CalEEMod and instead were modeled separately using locomotive emissions inventories published by the EPA (EPA, 2012) analyzed separately from CalEEMod. Emissions inventories and calculations for locomotives onsite are provided in Appendix B.

**Project Related Operational Emissions**

Based on the CalEEMod analysis, the Project buildout would generate 465 MT CO<sub>2</sub>e annually without the use of locomotives, which is shown in Table 9 below. Locomotives were estimated to generate 6,822 MT CO<sub>2</sub>e annually. Combined, the Proposed Project would generate 7,482.81 MT CO<sub>2</sub>e annually as shown in Table 9 below. Based on this, the project would not exceed the 10,000 MT annual screening threshold and would generate a less than significant operational GHG impact.

**Table 9: Operational GHG Emissions (MT/Year)**

Source	Bio-CO2	NBio-CO2	Total CO2	CH4	N2O	CO2e (MT/Yr)
Area	0.00	0.03	0.03	0.00	0.00	0.03
Energy	0.00	443.04	443.04	0.05	0.00	446.84
Mobile	0.00	13.00	13.00	0.00	0.00	13.12
Waste	50.75	0.00	50.75	3.00	0.00	125.73
Water	3.81	58.13	61.93	0.40	0.01	75.08
<b>Project GHG Emissions without locomotives</b>						<b>660.79</b>
<b>Locomotive Emissions</b>						<b>6,822.02</b>
<b>Total Emissions</b>						<b>7,482.81</b>
Data is presented in decimal format and may have rounding errors.						

a) Generate greenhouse gas emissions, either directly or indirectly, that may have a significant impact on the environment?

b) Conflict with an applicable plan or policy or regulation adopted for the purpose of reducing the emissions of greenhouse gases?

**a) and b) Less than Significant Impact.** There are currently no regional or local climate action plans or general or specific plan provisions to reduce GHG emissions in the study area. The only applicable plan is the set of regulations to be developed under AB 32, which has a target of reducing GHG emissions to 1990 levels by 2020. The potential significance of emissions from the Project



Potentially Significant Impact (PSI)	Less Than Significant With Mitigation Incorporated (LTSWMI)	Less Than Significant Impact (LTSI)	No Impact (NI)
--------------------------------------	---	-------------------------------------	----------------

therefore depends upon the extent to which the project furthers or hinders implementation of AB 32. Given the net reduction in GHG emissions, the project would further the implementation of AB 32.

As discussed above, the development of the Project will produce approximately a maximum of 1,599.06 MT of CO2e within the first year of construction. Based on SQAQMD methodology, the Project would not exceed the 10,000 MT screening threshold for CO2e during any of the expected construction years. Additionally, the Project operations will generate 660.79 MT CO2e annually without the use of locomotives and 6,822 MT CO2e annually with them. Combined, the Project would generate 7,482.81 MT CO2e annually and would not exceed the 10,000 MT annual screening threshold. Impacts would be less than significant.

**IX HAZARDS AND HAZARDOUS MATERIALS *Would the project:***

- |   |                          |                                     |                                     |                                     |
|---|--------------------------|-------------------------------------|-------------------------------------|-------------------------------------|
| a) Create a significant hazard to the public or the environment through the routine transport, use, or disposal of hazardous materials?   | <input type="checkbox"/> | <input checked="" type="checkbox"/> | <input type="checkbox"/>            | <input type="checkbox"/>            |
| b) Create a significant hazard to the public or the environment through reasonable foreseeable upset and accident conditions involving the release of hazardous materials into the environment?   | <input type="checkbox"/> | <input checked="" type="checkbox"/> | <input type="checkbox"/>            | <input type="checkbox"/>            |
| c) Emit hazardous emissions or handle hazardous or acutely hazardous materials, substances, or waste within one-quarter mile of an existing or proposed school?   | <input type="checkbox"/> | <input type="checkbox"/>            | <input checked="" type="checkbox"/> | <input type="checkbox"/>            |
| d) Be located on a site, which is included on a list of hazardous materials sites compiled pursuant to Government Code Section 65962.5 and, as a result, would it create a significant hazard to the public or the environment?   | <input type="checkbox"/> | <input type="checkbox"/>            | <input checked="" type="checkbox"/> | <input type="checkbox"/>            |
| e) For a project located within an airport land use plan or, where such a plan has not been adopted, within two miles of a public airport or public use airport, would the project result in a safety hazard or excessive noise for people residing or working in the project area? | <input type="checkbox"/> | <input type="checkbox"/>            | <input type="checkbox"/>            | <input checked="" type="checkbox"/> |
| f) Impair implementation of or physically interfere with an adopted emergency response plan or emergency evacuation plan?   | <input type="checkbox"/> | <input type="checkbox"/>            | <input checked="" type="checkbox"/> | <input type="checkbox"/>            |
| g) Expose people or structures, either directly or indirectly, to a significant risk of loss, injury or death involving wildland fires?   | <input type="checkbox"/> | <input type="checkbox"/>            | <input checked="" type="checkbox"/> | <input type="checkbox"/>            |

Potentially Significant Impact (PSI)	Less Than Significant With Mitigation Incorporated (LTSWMI)	Less Than Significant Impact (LTSI)	No Impact (NI)
--------------------------------------	---	-------------------------------------	----------------

**Summary of Impacts Identified in the MEIR:**

As previously mentioned, Geology and Soils, Hazards and Hazardous Materials, and Public Services related to fire, were all discussed under the Hazards and Hazardous Materials section of the MEIR in 2006.

The handling, storage, and transport of hazardous materials are regulated by federal and State codes. Within Imperial County, the EHS of the Public Health Department administers the requirements of the State Health and Safety Code that a Business Plan be prepared for businesses that handle more than 500 pounds of a solid substance, 55 gallons of a liquid, or 200 cubic feet of a compressed gas. The Business Plan is required to provide an inventory and map of materials stored or used on the premises, an emergency response plan, and employee training procedures for materials handling and emergency actions. The EHS Division conducts routine inspections of businesses required to submit Business Plans and requires updates at least every 3 years. Businesses are also required to notify specified State and local authorities of an imminent or actual on-site emergency so that action to avoid or minimize public health or environmental impacts can be taken.

In addition to the County EHS Business Plan program, businesses within the MEIR will also be subject to regulation by the California Office of Emergency Services under the California Accidental Release Prevention (CalARP) Program. The CalARP program merges the federal and State programs for the prevention of accidental release of regulated toxic and flammable substances from stationary sources that handle more than a threshold quantity of regulated substances. The regulated substances and their threshold quantities are specified in Section 2770.5 of the CalARP Program contained in the California Code of Regulations, Title 19, Division 2, Chapter 4.5. The CalARP Program requires that a Risk Management Plan and an Emergency Response Program be prepared and submitted to the County EHS.

The MEIR noted that the County EHS Division would determine the need for a Business Plan pursuant to the State Health and Safety Code. Business Plans would be required for the storage of hydrocarbon fuels, solvents, and other substances necessary for the maintenance of vehicles and equipment. The MEIR also noted that potential human and wildlife exposure to hazards could also result from storage or evaporation ponds for containment of wastewater from industrial processes that might contain toxic substances.

The MEIR concluded that with compliance with County EHS Division requirements for a Business Plan and CalARP Program requirements for a Risk Management Plan and an Emergency Response Program, as further required in compliance with mitigation, significant impacts associated with handling of hazardous materials would be avoided. The measures relevant to the proposed Project are as follows:

**Mitigation Measure 4.7.4:** Prior to approval of a final map, grading plan, or building permit for any phase or unit of development within the Specific Plan, the applicant shall provide evidence to the Planning and Development Services Director that (1) a hazardous materials Business Plan has been prepared and implemented in accordance with federal, state, and local regulations; and (2) all local, state, and federal permit requirements to generate, use, store, and transport hazardous materials have been satisfied. This evidence shall include a determination by the County EHS Division whether toxic substances may be present in wastewater or stormwater runoff directed to a storage pond. If toxic substances could be present, measures shall be implemented to prevent such transport of toxic substances or to prevent human and wildlife, including birds, access to the storage pond. Additionally, in coordination with the County Fire Department's Office of Emergency Services and the Hazardous Materials Response Team, specific routes shall be established for the transport of hazardous materials to avoid public use areas.

**Mitigation Measure 4.7.5:** For any project determined by the Planning and Development Services Director to require County EHS approval under the CalARP Program, and prior to approval of a final map, grading plan, or building permit for any such project, the applicant shall provide evidence to the Planning and Development Services Director that (1) a determination has been made by the County EHS Division on the need for project approval under the CalARP Program to prevent accidental release of regulated toxic and flammable substances from stationary sources that handle more than the threshold quantity of regulated substances; and if applicable to the project, (2) all local, state, and federal permit requirements to prevent accidental release of regulated toxic and flammable substances pursuant to the CalARP Program have been satisfied, including the requirement for preparation of a Risk Management Plan and an Emergency Response Program.

Impacts regarding wildfires are further discussed in Section X, Wildfire, however as mentioned, wildfire impacts were not previously discussed in the MEIR, as the thresholds were not a required topic in 2006.

**Impacts Related to the Proposed Project:**

- |   |                          |                                     |                          |                          |
|---|--------------------------|-------------------------------------|--------------------------|--------------------------|
| a) Create a significant hazard to the public or the environment through the routine transport, use, or disposal of hazardous materials?   | <input type="checkbox"/> | <input checked="" type="checkbox"/> | <input type="checkbox"/> | <input type="checkbox"/> |
| b) Create a significant hazard to the public or the environment through reasonable foreseeable upset and accident conditions involving the release of hazardous materials into the environment? | <input type="checkbox"/> | <input checked="" type="checkbox"/> | <input type="checkbox"/> | <input type="checkbox"/> |

**a and b) Consistent with the MEIR, Less than Significant with Mitigation.** The Proposed Project proposes construction of a logistics center and rail loop tracks to connect to the existing UPPR. Project operations will involve transport of general commodities including grain and hay and potentially hazardous materials such as fuel. The Project will also include operations of a fueling station.

Potentially Significant Impact (PSI)	Less Than Significant With Mitigation Incorporated (LTSWMI)	Less Than Significant Impact (LTSI)	No Impact (NI)
--------------------------------------	---	-------------------------------------	----------------

During short-term construction activities, the Proposed Project would involve the use of heavy equipment for grading, hauling, and handling of the construction materials and equipment. Construction will require the temporary use of fuels and other similar materials that may have hazardous properties (such as flammability, corrosivity, combustibility, etc). During construction, the handling and disposal of these materials will be done to comply with the manufacturer's requirements and local, State, and federal regulations. Portable bins or other storage containers will be on site for storage of maintenance lube oils, chemicals, paints, and other construction materials, as needed. Hazardous materials that are expected to be used during construction will include:

- Unleaded gasoline
- Diesel fuel
- Oil
- Hydraulic fluids
- Lubricants
- Solvents
- Adhesives
- Paint material

The Proposed Project will involve the routine transport, use, and disposal of hazardous materials. Hazardous materials that are expected to be used during operation will include:

- Unleaded gasoline
- Diesel fuel
- Transformer Oil
- Hydraulic fluid

The Project would be required to implement mitigation measure 4.7.4, which will require that the Project develop and implement a Hazardous Materials Business Plan (HMBP), in compliance with California Health and Safety Code, Division 20, Chapter 6.95, Sections 25500-25519 and California Code of Regulations, Title 19, Division 2, Chapter 4. The HMBP will be provided to the California Office of Emergency Services, the County Fire Department, and the Certified Unified Program Agency for the County (the local California Department of Toxic Substances Control office), for review and approval before plant operation. The HMBP will include, at a minimum, procedures for:

- Hazardous materials handling, use and storage;
- Emergency response;
- Spill control and prevention;
- Employee training; and
- Reporting and record keeping.

The Proposed Project would also be required to implement mitigation measure 4.7.5, which requires compliance with the CalARP Program, including the requirement for preparation of a Risk Management Plan and an Emergency Response Program. Additionally, the Proposed Project may be required to prepare a Spill Prevention, Control and Countermeasure (SPCC) Plan given the nearby potentially navigable waters. The purpose of the SPCC Plan is to prevent the discharge of oil into navigable waters. For any occupational hazards that may be encountered by the workers, the Proposed Project would be required to comply with the California Occupational Safety and Health Administration (OSHA) that relate to worker risk of exposure and on-site safety procedures.

Hazardous material carriers and hazardous waste transporters are required by law to adhere to applicable local, State, and federal regulations regarding proper truck signage, indicating the materials being transported, carrying a shipping/waste manifest of the types and concentrations of materials being transported, and other appropriate measures. Hazardous material carriers also are responsible for their loads, reporting spills, and initiating appropriate emergency response to releases of any transported hazardous materials, from the point of origin up to the destination of the hazardous material delivery.

Given the proposed construction and operations of the Project, adherence with the required mitigation, and compliance with local, State, and federal regulations, impacts associated with the proposed Project would be less than significant.

- c) Emit hazardous emissions or handle hazardous or acutely hazardous materials, substances, or waste within one-quarter mile of an existing or proposed school?

**c) Consistent with the MEIR, Less Than Significant Impact.** The Proposed Project is not located within one-quarter mile of an existing or proposed school. The nearest schools are located south of the Project site within the City of Imperial downtown area, the nearest being Frank Wright Middle School, which is approximately 2.75 miles driving distance south (Google 2023). The Proposed Project will connect to the existing UPPR railroad for goods transport. The UPPR railroad is an existing railway system that has historically transported materials through the City. The proposed operations would not be introducing new materials to be transported by UPPR. In addition, the UPPR railway line in the City of Imperial is not located adjacent to any existing schools. Therefore, impacts would be less than significant.

	Potentially Significant Impact (PSI)	Less Than Significant With Mitigation Incorporated (LTSWMI)	Less Than Significant Impact (LTSI)	No Impact (NI)
--	--------------------------------------	---	-------------------------------------	----------------

- d) Be located on a site, which is included on a list of hazardous materials sites compiled pursuant to Government Code Section 65962.5 and, as a result, would it create a significant hazard to the public or the environment?

**d) Consistent with the MEIR, Less than Significant Impact.** According to the State Water Resources Control Board (SWRCB) Geotracker (SWRCB 2023) and DTSC EnviroStor (DTSC 2023) databases, the nearest leaking underground storage tank (LUST) clean-up site is located at Empire Southwest Company at 3393 Highway 86, immediately west of the Project site. The LUST cleanup site case began with the discovery of a leak. The potential contaminants of concern found during the investigation involved gasoline. The leak was reported in 1988 with the case closed as of 1992. No other leaks were reported at Empire Southwest Company or in any other areas within 1,000 feet of the Project site. Therefore, the Proposed Project is not expected to result in the release of hazardous materials into the environment from existing sites that may have contained hazardous materials. Impacts would be less than significant.

- e) For a project located within an airport land use plan or, where such a plan has not been adopted, within two miles of a public airport or public use airport, would the project result in a safety hazard or excessive noise for people residing or working in the project area?

**e) Consistent with the MEIR, No Impact.** The nearest airport to the Project is the Imperial County Airport, which is approximately 3 miles to the south (Google 2023). Because the Project is not located near an airport or within an airport zone of influence, the Project would not result in a safety hazard or excessive noise. Therefore, no impacts would occur.

- f) Impair implementation of or physically interfere with an adopted emergency response plan or emergency evacuation plan?

**f) Consistent with the MEIR, Less Than Significant Impact.** Temporary or single-lane closure of some roadways may occur during the transport of oversized equipment or construction activities. Road closures would be coordinated with County Public Works, the County Sheriff, and ICFD prior to closure, and would be scheduled to occur during off-peak commute hours. The Project's construction and operational activities would be in compliance with the Imperial County Emergency Operations Plan (EOP) and Multi-Jurisdiction Hazard Mitigation Plan (MJHMP), and would not physically interfere with the execution of the policies and procedures in these plans (County 2015b; 2016b). Therefore, the Project would not impair implementation of or physically interfere with an adopted emergency response plan or emergency evacuation plan. Impacts would be less than significant.

- g) Expose people or structures, either directly or indirectly, to a significant risk of loss, injury or death involving wildland fires?

**g) Less than Significant Impact.** The California Department of Forestry and Fire Protection's Fire and Resource Assessment Program (FRAP) provides a Fire Hazards Severity Zone Viewer (FHSZ) to provide a visual reference to locate fire hazards areas in California. The maps were developed utilizing science and field-tested models that assign a hazard score based on factors that influence fire likelihood and behavior. Factors include but are not limited to fire history, existing and potential fuel (natural vegetation), predicted flame length, embers, terrain, and typical fire weather in the area.

The Project site is not located within a FHSZ area. Most of the moderate to very high fire hazard areas are located to the north adjacent to the Salton Sea near Salton City, Anza-Borrego Desert State Park, and the Cleveland National Forest. There are no areas within the immediate vicinity of the Project site that are designated as areas that have potential for wildland fires.

The Proposed Project may utilize solar panels for Project operations. The solar panels could utilize a battery energy storage element, which may result in an additional fire hazard. However, if a battery storage element is utilized, it would require approval from the County Planning Department, prior to installation. Additionally, as noted in Section V Public Services, as required by mitigation measure 4.7.8, the Project the applicant would be required to provide evidence to the Planning and Development Services Director that a determination has been made by the County Fire Department that an adequate system for delivery of an adequate supply of water for fire suppression, and other required equipment, alarms, and water connections, is provided to serve the project. Therefore, with implementation of this mitigation, impacts would be less than significant.

**X HYDROLOGY AND WATER QUALITY** *Would the project:*

- a) Violate any water quality standards or waste discharge requirements or otherwise substantially degrade surface or ground water quality?
- b) Substantially decrease groundwater supplies or interfere substantially with groundwater recharge such that the project



	Potentially Significant Impact (PSI)	Less Than Significant With Mitigation Incorporated (LTSWMI)	Less Than Significant Impact (LTSI)	No Impact (NI)
may impede sustainable groundwater management of the basin?				
c) Substantially alter the existing drainage pattern of the site or area, including through the alteration of the course of a stream or river or through the addition of impervious surfaces, in a manner which would:				
(i) result in substantial erosion or siltation on- or off-site;	<input type="checkbox"/>	<input checked="" type="checkbox"/>	<input type="checkbox"/>	<input type="checkbox"/>
(ii) substantially increase the rate or amount of surface runoff in a manner which would result in flooding on- or offsite;	<input type="checkbox"/>	<input checked="" type="checkbox"/>	<input type="checkbox"/>	<input type="checkbox"/>
(iii) create or contribute runoff water which would exceed the capacity of existing or planned stormwater drainage systems or provide substantial additional sources of polluted runoff; or;	<input type="checkbox"/>	<input checked="" type="checkbox"/>	<input type="checkbox"/>	<input type="checkbox"/>
(iv) impede or redirect flood flows?	<input type="checkbox"/>	<input type="checkbox"/>	<input checked="" type="checkbox"/>	<input type="checkbox"/>
d) In flood hazard, tsunami, or seiche zones, risk release of pollutants due to project inundation?	<input type="checkbox"/>	<input type="checkbox"/>	<input checked="" type="checkbox"/>	<input type="checkbox"/>
e) Conflict with or obstruct implementation of a water quality control plan or sustainable groundwater management plan?	<input type="checkbox"/>	<input checked="" type="checkbox"/>	<input type="checkbox"/>	<input type="checkbox"/>

**Summary of Impacts Identified in the MEIR:**

The MEIR analyzed the potential impacts to hydrological conditions and water quality associated with build out of the Specific Plan. The MEIR discussed flooding, surface water, rainfall, groundwater, and water quality. A summary of the existing conditions are discussed below:

**Flooding**

The MEIR noted that the Specific Plan contains a depressed "sink" area adjacent to Keystone Road that causes water to be detained during heavy rainstorms, which can make Keystone Road impassable. The MEIR included migration for projects near Keystone Road or within the Mesquite Lake lakebed.

**Surface Water**

The MEIR noted that surface waters in the Valley mostly drain toward the Salton Sea (north).

**Rainfall**

The MEIR noted that the average annual precipitation ranges from less than 3 inches over most of the planning area, to 8 inches in the mountains along the western border.

**Groundwater**

The MEIR noted that groundwater is stored in the Pleistocene sediments of the valley floor, the mesas on the west, and the East Mesa and sand hills on the east. However, the fine-grained lake sediments in the central portion of Imperial Valley inhibit groundwater movement. Tile-drain systems are used to dewater sediments to a depth below the root zone of crops to prevent the surface accumulation of saline water. Few wells have been drilled in these lake sediments because the yield is poor and the water is generally saline. The few wells in the Valley are for domestic use only.

**Water Quality**

The Mesquite Lake Specific Plan area is located within the Colorado River Basin, which contains two substantial surface water bodies of State and national significance: the Colorado River and the Salton Sea. The major local rivers that flow into the Salton Sea are the New and Alamo rivers, both of which originate in Mexico. The New River carries treated wastewater from point sources in the Imperial Valley, as well as in Mexico; and the Alamo River carries mostly agricultural return flows and treated municipal wastewater from the Imperial Valley. Existing topographic conditions in the project area direct drainage to the Alamo River via the Rose Outlet, which discharges approximately 4 miles northeast of the project site. The New River is approximately 2 miles west of the project site, but is upgradient and is separated from the project site by the Central Main Canal.

The Valley's agricultural drain system provides over 1,450 miles of surface drains that discharge directly into the Alamo and New rivers, and the Salton Sea. The Imperial Valley portion of the Colorado River Basin region faces several water quality issues, including increasing salinity,

Potentially Significant Impact (PSI)	Less Than Significant With Mitigation Incorporated (LTSWMI)	Less Than Significant Impact (LTSI)	No Impact (NI)
--------------------------------------	---	-------------------------------------	----------------

selenium, and eutrophication in the Salton Sea; and silt, nutrient, and pesticide pollution of the agricultural drains and the New and Alamo rivers. Discharges of water and stormwater runoff into the Valley's drains and river systems are subject to federal and State water quality regulations.

The MEIR concluded that from a watershed perspective, the topography, soil condition, vegetation, drainage features and other relevant hydrology and water quality factors would not be adversely affected by development within the Specific Plan Area, with implementation of the listed mitigation. The MEIR provided both general mitigation measures for all projects within the Specific Plan, as well as project-specific mitigation measures for the developments that were proposed at the time of the Specific Plan implementation. Some of the previously proposed projects are similar to the proposed Project, and therefore, some project-specific mitigation measures will be relevant for the proposed Project. Alternatively, the Project site is not located in or near the Mesquite Lake depression area and therefore some general mitigation measures do not apply. The relevant mitigation measures are as follows:

**General Mitigation Measures:**

**Mitigation Measures 4.2.1:** Hydrological Analysis: As part of the building permit application process for each project, a hydrologic analysis shall be conducted to determine that:

- The proposed project would not cause undercutting erosion, slope stability degradation, vegetative stress (due to flooding, erosion, water quality degradation, or loss of water supplies), sedimentation, or habitat alteration in downstream areas as a result of an altered flow regime.
- Downstream IID drainage systems would have sufficient capacity to convey the increase in site runoff due to the increase in impervious surfaces, and the ability to attenuate the resulting peak flows.
- Any on-site BMPs are designed in accordance with the County Engineering Design Guidelines Manual (County of Imperial 2004) and to the satisfaction of the County Engineer.

**Mitigation Measure 4.2.2:** Hydrologic Design: Based on the hydrological analysis conducted in the MEIR, natural hydrologic designs shall be integrated into site layouts to the maximum extent practicable by:

- Reducing imperviousness and directly connected impervious surfaces to facilitate natural infiltration of runoff, conserving natural resources and areas, maintaining and using natural drainage courses in the stormwater conveyance system, and minimizing clearing and grading.
- Providing runoff storage measures dispersed uniformly throughout a site's landscape with the use of a variety of detention, retention, and runoff practices.
- Implementing on-site hydrologically functional landscape design and management practices.
- Incorporating pervious pavements wherever practicable.

**Mitigation Measure 4.2.3:** Construction Stormwater Pollution Prevention Plan: Prior to issuance of a grading permit for any phase or unit of development within the Specific Plan, an NOI shall be submitted to the SWRCB, and an SWPPP shall be developed and implemented on-site in compliance with Water Quality Order 99-08-DWQ/NPDES General Permit No. CAS000002 (General Construction Permit). The County Director of Public Works shall be provided an opportunity to review the SWPPP as part of the review/approval process at least 30 days prior to construction. The SWPPP shall include, but shall not be limited to, the following:

- BMPs to prevent construction-related pollutants from being exposed to runoff that can transport pollutants into nearby receiving waters. The selection and placement of BMPs shall be designed to protect all areas disturbed by construction activities from erosive forces and capture sediment from stormwater before it leaves the site. Erosion and sediment controls shall include both stabilization (erosion control) and structural (sediment control) measures. These measures shall be implemented such that the exposure of unprotected, disturbed earth during site development is minimized to the shortest duration practicable.
- Soil-tracking BMPs to limit off-site transport of sediment from the construction areas by implementing tire-cleaning measures such as stabilized construction entrance/exit designs (e.g., metal corrugated shaker plates, gravel strips, and/or wheel-washing facilities) at access points.
- Inspect/maintain all erosion and sediment control measures for proper integrity and function during the entire construction period. All stabilization and structural controls shall be inspected at least monthly or after any significant storm event and shall be repaired or maintained for optimum performance. Access to these facilities shall be maintained during wet weather.

Potentially Significant Impact (PSI)	Less Than Significant With Mitigation Incorporated (LTSWMI)	Less Than Significant Impact (LTSI)	No Impact (NI)
--------------------------------------	---	-------------------------------------	----------------

- Examples of erosion control include:
  - slope benching and terracing
  - soil roughening
  - temporary revegetation
  - soil stabilizers
  - mulches and matrices
  - erosion control blankets
  - fiber rolls
- Examples of sediment control include:
  - perimeter controls (e.g., gravel bag or straw bale berms, silt fence)
  - stormwater inlet protection (e.g., fiber roll, gravel bags, geofabric grate covering)
  - silt fencing
  - gravel construction site entrance/exits
  - truck tire wheel wash
  - check dams
- Material and waste management programs during construction such as solid, sanitary, septic, hazardous, contaminated soil, concrete, and construction waste management; spill prevention; appropriate material delivery and storage; employee training; dust control; and vehicle and equipment cleaning, maintenance, and fueling. Each of these programs would address proper secondary containment requirements, spill prevention and protection, structural material storage needs, proper concrete wash-out design and containment, perimeter and surface protection for laydown and maintenance areas, and relaying all such requirements to construction staff.
- Structural and non-structural programs (i.e., routine procedures or practices) to reduce the amount of pollutants in runoff; to prohibit the storage of uncovered hazardous substances in outdoor areas; to prohibit the use of pesticides and herbicides; and to prevent spills.
- A monitoring program involving inspection and maintenance procedures for all post-construction stormwater pollution control measures to ensure that they continue to function properly. The monitoring program shall specify the monitoring entity; the funding source for the inspection/monitoring program; and enforcement provisions in the event of failure to implement, operate, or maintain the approved stormwater pollution control measures.
- Maintaining records of all stormwater control measure implementation, inspection, and maintenance activities for at least 5 years.

**Mitigation Measure 4.2.4:** Industrial SWPPP: Thirty (30) days prior to new facility start-up for any phase or unit of development within the Specific Plan, an NOI shall be submitted to the SWRCB, and a SWPPP shall be developed and implemented on-site in compliance with Water Quality Order 97-03-DWQ/NPDES General Permit No. CAS000001 (General Industrial Permit), which requires:

- Verifying that any illicit connections to storm drains have been eradicated.
- Incorporating non-structural and structural BMPs to reduce pollutants in site runoff, such as outfall protection and treatment devices, proper storage and disposal of potential pollutants, secondary containment protection, and prohibiting pesticide and herbicide use; waste management, employee training, erosion control, vehicle/equipment cleaning, maintenance, and fueling; spill prevention/response practices; and shipping/receiving practices. Storage of potential pollutants shall be contained within approved safety lockers with secondary containment, within constructed secondary containment structures, or stored off-site in suitable protective enclosures. Disposal shall occur at an authorized landfill, waste collection center, or other certified disposal facility approved for disposing the waste in question. The methods and procedures shall be consistent with the philosophies of EPA and California guidance documentation for industrial stormwater pollution prevention.

Developing and executing a Monitoring and Reporting Program to assess the effectiveness of BMPs through visual inspection of storm drains and outfall points during wet and dry weather and storm sampling. The program shall also address the maintenance needs of any on-site BMPs to ensure optimum functionality.

- Preparing and submitting an annual report to the RWQCB with monitoring results.
- Maintaining all related records of all control measure implementation, inspection, and maintenance for at least 5 years.

**Mitigation Measure 4.2.5, Service Area Agreement:** The Imperial County Planning and Development Services Director shall review and approve the County Service Area agreement or other documents establishing an independent authority responsible for operation of public facilities and services within the Specific Plan. The agreement or other documents shall include information sufficient to address the ongoing maintenance of stormwater facilities on individual lots/parcels as well as future storm drain systems within the County road rights-of-way. These considerations

Potentially Significant Impact (PSI)	Less Than Significant With Mitigation Incorporated (LTSWMI)	Less Than Significant Impact (LTSI)	No Impact (NI)
--------------------------------------	---	-------------------------------------	----------------

shall include, but not be limited to, maintaining erosion control BMPs to minimize on-site soil loss, clearing of sediment from BMPs on an as-needed basis, trash and debris collection (aesthetic maintenance), and maintaining public safety. The agreements shall demonstrate that there are sufficient funding sources to operate these facilities in an environmentally responsible manner, and that stormwater controls will be implemented and maintained throughout their operational lifetime.

Relevant Portions of Project Specific Mitigation Measures:

**Mitigation Measure 4.2.6:**

**Storage and Biosolids**

- Storage silos and other tanks or containment systems shall incorporate spill control and secondary containment design.
- Biosolids haul trucks shall be washed at the biosolids reception units, which shall be paved and designed to direct all washwater into the storage silos for incineration in the project's furnaces. No other truck or equipment wash areas shall be permitted without approval of the County Planning and Development Services Department and RWQCB to ensure that all potential pollutants are directed into plant incinerators or other County-approved system equally effective at disposal of washwater.

**Mitigation Measure 4.2.8:**

**Fueling Station**

The fueling area shall incorporate the following: (1) self-containing sumps or other retaining devices to capture a spill from the largest fuel delivery, plus 10 percent; (2) the fueling area shall be covered with a roof or overhang; (3) the drainage around the perimeter of the fueling area shall be sloped to convey any spills inward toward the fueling area sump and slopes outside the fueling area shall divert sheet flow away from the fueling area to avoid runoff contamination; (4) be equipped with a clarifier, grease trap, or other pretreatment facility, as appropriate; (5) be equipped with spill kits; (6) be provided with other features that are comparable or equally effective.

**Stockpiles**

Any stockpiling of materials near the stormwater retention basin shall have perimeter controls to capture debris and other materials that could be transported by wind or stormwater to the retention basin.

**Stormwater Retention Basin**

The stormwater retention basin shall be designed to appropriately treat all water released to the Rose Drain such that any off-site discharge causes no further impairment of local water quality and complies with IID specifications and all other locally imposed performance-based regulations.

The retention pond shall also be designed to retain the volume generated by a 100-year frequency storm. An emergency drain valve shall incorporate a standpipe to bleed off surface water from the retention basin such that sediment and other settled materials are not conveyed to the natural drainage in the event of severe rainfall. Protocols for managing the emergency release of such waters shall meet all requirements of the IID, County EHS, the RWQCB, the CDFG, and the County Planning and Development Services Department.

**Impacts Related to the Proposed Project:**

- a) Violate any water quality standards or waste discharge requirements or otherwise substantially degrade surface or ground water quality?

**a) Consistent with the MEIR, Less than Significant with Mitigation.** As mentioned above, groundwater is stored in the Pleistocene sediments of the valley floor, mesas to the east, and East Mesa and sand hills in the east. The sediments within the central portion of Imperial Valley inhibit groundwater movement. Therefore, tile-drain systems are used to dewater the sediments below the root zone of the crops to prevent accumulation of saline water on the surfaces. There are only a few wells in the Valley for domestic use.

The Proposed Project is located within the Mesquite Lake Specific Plan, which is within the Colorado River Basin. It contains two surface water bodies that are state and national significance which are the Colorado River and the Salton Sea. Surface waters within the Imperial Valley drain north towards the Salton Sea. The Alamo and New rivers convey agricultural irrigation drainage water, surface runoff, and treated municipal and industrial waste waters from the Imperial Valley to the Salton Sea.

The Project proposes construction and operation of an industrial logistics center for food and commodity imports and exports, warehousing, rail loop and ladder tracks to connect to the existing UPRR, and a fueling station. Construction and operational discharges could generate sediments, debris, oil and grease residue, feed stocks and food products and would be from activities such as truck washout, site cleanups, accidental spills and other similar activities that may be carried over during rain or site water uses. Potential impacts during construction and operation are described below.

**Construction Impacts**

As previously discussed in the MEIR, any development occurring within the Specific Plan would not result in adverse impacts with



Potentially Significant Impact (PSI)	Less Than Significant With Mitigation Incorporated (LTSWMI)	Less Than Significant Impact (LTSI)	No Impact (NI)
--------------------------------------	---	-------------------------------------	----------------

implementation of the required permitting, construction measures and mitigation measures. Similar to the MEIR, the Project would be required to implement mitigation measures 4.2.1 and 4.2.2, which would ensure that runoff amount would be minimized, and that BMPs approved by the County engineer, would be implemented to ensure that runoff would not violate water quality. Additionally, mitigation measure 4.2.3 would be implemented which would require a stormwater pollution prevention plan (SWPPP) be developed to prevent construction-related pollutants from being exposed to runoff. With implementation of these mitigation measures, impacts would be less than significant.

**Operational Impacts**

Implementation of the Project could result in accidental releases and/or spills due to normal operations which could affect water quality. Similar to the MEIR, the Project would be required to implement mitigation measure 4.2.4, which would require that 30 days prior to the start of the project, that a notice of intent (NOI) be submitted to the SWRCB, and an industrial SWPPP be developed and implemented on-site to ensure that runoff during operation would not violate any water quality standards. Nonetheless, the fueling stations could result in accidental spills. The fueling process is proposed to occur within enclosed tanks which would be designed to prevent leakage, however, the Project will also develop and implement a Hazardous Materials Business Plan (HMBP) as required by mitigation measures 4.7.4 above, in compliance with California Health and Safety Code, Division 20, Chapter 6.95, Sections 25500-25519 and California Code of Regulations, Title 19, Division 2, Chapter 4. The HMBP will be provided to the California Office of Emergency Services, the County Fire Department, and the Certified Unified Program Agency for The County (the local California Department of Toxic Substances Control office), for review and approval before plant operation. The HMBP will include, at a minimum, procedures for hazardous materials handling, use and storage; emergency response; spill control and prevention; employee training; and reporting and record keeping.

In addition to preparation of the HMBP, the Project would conduct a hydrological analysis and design the Project around the findings of the analysis, as discussed in mitigation measures 4.2.1 and 4.2.2, in order to ensure that runoff amount would be minimized, and that runoff would not violate water quality. Additionally, the proposed Project would be required to implement applicable parts of MEIR mitigation measures 4.2.6 and 4.2.8 as written above, to ensure compliance with onsite storage and containment, biosolids, fueling, stockpiles, and the stormwater retention basin. The stormwater retention basin would be constructed and designed to meet the County Engineering Design Guidelines

With implementation of the aforementioned mitigation measures and the HMBP, operation of the proposed Project would not violate any water quality standards, and consistent with the MEIR, impacts would be less than significant.

- b) Substantially decrease groundwater supplies or interfere substantially with groundwater recharge such that the project may impede sustainable groundwater management of the basin?

**b) Consistent with the MEIR, Less than Significant Impact.** As discussed in the MEIR, development within the Specific Plan will receive raw water service from IID. The Proposed Project would result in a net decrease water demand of 1,528 acre-feet per year (AFY).

The Project will include a water treatment, storage and distribution system that will satisfy potable water and fire water requirements. The system will receive water from the IID Dahlia Lateral 8 canal located along the southerly boundary of the Project. The treatment, storage and pump elements of the system will be located on an approximately 2-acre lot in the Project. The distribution element of the system will be a looped pressurized water line located within the Project roadway that will provide access to water for all Project parcels. The water treatment, storage and distribution system will likely be developed in phases with an initial phase having a storage capacity of approximately 180,000 gallons and a built-out storage capacity of up to 1.5 million gallons. Conversely, during initial site operations and prior to the need for a public water system, the Project may truck in purified/potable water. A 1.5 million gallon tank would be approximately 50 feet tall and approximately 100 feet in diameter. The Project will also have raw water service from IID Dahlia Lateral 8 for industrial process water.

A Water Supply Assessment (WSA) was prepared for the proposed Project for all water demands, to show water supply is able to meet demand over the next 54 years.

The introduction of new impervious surfaces to the Project would affect the amount of water absorption through the soils. However, the Project would implement mitigation measures 4.2.1 and 4.2.2 which would ensure that the amount and quality of stormwater would remain as unchanged as possible. The entire Project site would drain into a stormwater retention basin located on the northern portion of the Project site that is approximately 20 acres. This basin connects and would drain into the IID Newside Drain Number 1-A after upgrading the site's historical connection to said IID drain. The retention basin will be designed to meet SWRCB requirements and will include an appropriate mosquito abatement per County guidelines if the retention basin does fully discharge in less than 72 hours. With implementation of these mitigation measures and project design features, impacts would be consistent with the MEIR.

	Potentially Significant Impact (PSI)	Less Than Significant With Mitigation Incorporated (LTSWMI)	Less Than Significant Impact (LTSI)	No Impact (NI)
--	--------------------------------------	---	-------------------------------------	----------------

c) Substantially alter the existing drainage pattern of the site or area, including through the alteration of the course of a stream or river or through the addition of impervious surfaces, in a manner which would:

- (i) result in substantial erosion or siltation on- or off-site;
- (ii) substantially increase the rate or amount of surface runoff in a manner which would result in flooding on- or offsite;
- (iii) create or contribute runoff water which would exceed the capacity of existing or planned stormwater drainage systems or provide substantial additional sources of polluted runoff?

**c) i) through iii) Consistent with the MEIR, Less Than Significant Impact with Mitigation.** Drainage patterns are typically formed by the streams, rivers, lakes or other bodies of water. Overtime, the system is formed via a network of channels and tributaries that are determined the type of geologic features of a particular landscape. Soil erosion occurs when water or wind deteriorates soil particles in a given area. Siltation is caused by soil erosion and occurs when dirt, soil and sediment is carried by water and is accumulated.

The Proposed Project would require grading of the Project site which could affect the existing topographic and drainage features of the site. In addition, the proposed construction work could result in soil disturbance that could result in soil erosion or siltation.

However, the Project would implement mitigation measures 4.2.1 and 4.2.2 which would ensure that drainage, including erosion control, would be evaluated and that proper BMPs be implemented. Additionally, mitigation measures 4.2.3 and 4.2.4 would require SWPPPs during both construction and operation respectively, to ensure that erosion control, runoff, and spill prevention would be properly managed via BMPs.

Additionally, the Project would implement mitigation measure 4.2.5 which would require that the Project prepare a service area agreement with the County to address the ongoing maintenance of stormwater facilities on the site, as well as future storm drain systems within the County road rights-of-way. The agreement considerations shall include, but not be limited to, maintaining erosion control BMPs to minimize on-site soil loss, clearing of sediment from BMPs on an as-needed basis, trash and debris collection (aesthetic maintenance), and maintaining public safety. The agreement should also demonstrate that there are sufficient funding sources to operate these facilities in an environmentally responsible manner, and that stormwater controls will be implemented and maintained throughout their operational lifetime.

With implementation of mitigation measures 4.2.1 through 4.2.5, impacts related altering drainage, erosion, and runoff, would be considered less than significant.

- (iv) impede or redirect flood flows?

**c) iv) Consistent with the MEIR, Less Than Significant Impact.** As mentioned above, the MEIR noted that the Specific Plan contains a depressed "sink" area adjacent to Keystone Road that causes water to be detained during heavy rainstorms, which can make Keystone Road impassable. However, this area along with the lakebed of Mesquite Lake are located over a mile north of the Project site. According to the Federal Emergency Management Agency (FEMA) Flood Insurance Rate Map (FIRM) number 06025C1375C, the Project site is located in Zone X, areas of 0.2% annual chance flood; areas of 1% annual chance flood with average depths of less than 1 foot or with drainage areas less than 1 square miles; and areas protected by levees from 1% annual chance flood (FEMA 2008). As such, impacts due to impeding or redirecting flows, would be less than significant.

- d) In flood hazard, tsunami, or seiche zones, risk release of pollutants due to project inundation?

**d) Consistent with the MEIR, Less Than Significant Impact.** Tsunamis are high sea waves typically caused by earthquakes and underwater landslides. Seiche occurs in bodies of water (semi or full-enclosed) and are caused by strong winds or rapid changes in the atmosphere that pushes water from one end to another and typically acts as a standing wave/oscillating body of water. Floods are an overflow of large bodies of water beyond its normal capacity. The proposed Project is over 20 miles from the nearest large body of water (Salton Sea) and over 90 miles from the ocean, therefore tsunamis or seiches would not occur.

As discussed above, according to the Federal Emergency Management Agency (FEMA) Flood Insurance Rate Map (FIRM) number 06025C1375C, the Project site is located in Zone X, areas of 0.2% annual chance flood; areas of 1% annual chance flood with average depths of less than 1 foot or with drainage areas less than 1 square miles; and areas protected by levees from 1% annual chance flood (FEMA 2008). As such, flood hazards would be less than significant.

- e) Conflict with or obstruct implementation of a water quality control plan or sustainable groundwater management plan?

**e) Consistent with the MEIR, Less Than Significant Impact with Mitigation** As described under Thresholds a and b above, the proposed Project would be required to implement mitigation measures to help ensure that impacts to water quality would remain less

	Potentially Significant Impact (PSI)	Less Than Significant With Mitigation Incorporated (LTSWMI)	Less Than Significant Impact (LTSI)	No Impact (NI)
--	--------------------------------------	---	-------------------------------------	----------------

than significant.

The proposed Project will utilize water from IID, which is ultimately sourced from the Colorado River. Nonetheless, a WSA was prepared for the proposed Project to show water supply is able to meet demand over the next 54 years. Additionally, the Project would implement mitigation measures 4.2.1 and 4.2.2 which would ensure that flow and drainage of the site would remain as unchanged as possible. With implementation of these mitigation measures, impacts would remain less than significant.

**XI LAND USE AND PLANNING Would the project:**

- |  |                          |                          |                                     |                                     |
|--|--------------------------|--------------------------|-------------------------------------|-------------------------------------|
| a) Physically divide an established community?   | <input type="checkbox"/> | <input type="checkbox"/> | <input type="checkbox"/>            | <input checked="" type="checkbox"/> |
| b) Cause a significant environmental impact due to a conflict with any land use plan, policy, or regulation adopted for the purpose of avoiding or mitigating an environmental effect? | <input type="checkbox"/> | <input type="checkbox"/> | <input checked="" type="checkbox"/> | <input type="checkbox"/>            |

**Summary of Impacts Identified in the MEIR:**

The MEIR discussed the impacts of the Specific Plan with regards to land use and zoning associated with the build out of the Specific Plan. A summary of the existing conditions are discussed below:

At the time of the preparation of the MEIR, the area contained a variety of existing agricultural, industrial and commercial uses as well as extensive vacant or fallow lands. Land uses onsite consisted of agricultural support services, agricultural processing, roofing and building materials, auto dismantling, a fleet storage and repair facility for a waste disposal company, a communications tower, and the Memory Gardens Cemetery and Memorial Park. Although caretaker dwellings may have been present, they were not located along public roads. Surrounding properties mainly included agricultural fields and one residence. The nearest urban centers were the City of Imperial (1 mile south) and Brawley (4 miles north). The Holly Sugar plant, two alternative-fuel-burning electrical power plants along Old Highway 111 and a 640-acre fish-farming operation are main land use operations existing in the area.

The designation of the Specific Plan was established by the 1993 County General Plan to provide opportunities to construct new job-producing light, medium, and heavy industrial uses. Future development, including the project-specific development of the MEIR summarized that these would be typical of the types of uses that would be developed in the future and, "...would have visual and operational characteristics that are generally not compatible with residential uses. The Specific Plan's permitted uses would also not be compatible with uses such as hospitals or care facilities where occupants would have reduced tolerance for dust, noise, and potential air contaminants that might be associated with heavy industrial uses. The plan does not permit residential uses, other than caretaker dwellings, or uses such as hospitals or care facilities."

The MEIR summarized that because the surrounding properties would be for agricultural and/or industrial purposes, it would avoid any potential for land use conflicts and therefore would not require mitigation measures. In addition, individual proposed projects are anticipated to conform to the land use goals and any permitting and conditions of approval shall be reviewed by the County to assure consistency with the land use and development regulations.

**Impacts Related to the Proposed Project:**

The Proposed Project is located within the adopted Mesquite Lake Specific Plan. As mentioned, the Project would require a specific plan amendment and a zone change to amend parcels, approximately 195 acres, from ML-GS and ML I-2 to ML I-3 and from Light and Medium Industrial to Heavy Industrial, as shown in Figure 5. The Project would also require new configuration of parcels via a Tentative Tract Map. The Heavy Industrial designation would allow for greater flexibility in terms of industrial uses. ML GS permits governmental facilities and special public facilities. ML I-2 permits medium industrial uses such as distribution center, warehousing, manufacturing, research and development and other similar medium intensity processing facilities. Other permitted uses include powerplants, truck and rail container storage and processing or fabrication. ML I-3 permits the most intense, heavy manufacturing or prefabrication facilities, in addition to permitted uses under ML I-2.

Additionally, the Project requires a variance request for any structures over 80 feet, which would include the grain elevator system that will be up to 180 feet tall and comprised of up to eight large tanks/bins.

The Project proposes construction and operation of an industrial park, logistics center for food and commodity imports and exports, and rail loop and ladder tracks to connect to the existing UPPR, and a fueling station. Additionally, the Project would include approval of a Tentative Tract Map.

- |   |                          |                          |                          |                                     |
|---|--------------------------|--------------------------|--------------------------|-------------------------------------|
| a) Physically divide an established community?  | <input type="checkbox"/> | <input type="checkbox"/> | <input type="checkbox"/> | <input checked="" type="checkbox"/> |
| a) <b>Consistent with the MEIR, No Impact.</b> The Project proposes construction and operation of an industrial park, logistics centers for food and commodity imports and exports, and rail loop and ladder tracks to connect to the existing UPPR, and a fueling station. The Proposed Project would not include the construction of new roadways or physical barriers between residential communities. |                          |                          |                          |                                     |

Potentially Significant Impact (PSI)	Less Than Significant With Mitigation Incorporated (LTSWMI)	Less Than Significant Impact (LTSI)	No Impact (NI)
--------------------------------------	---	-------------------------------------	----------------

The Project site does not contain any residences, nor is the area zoned for residential uses. As discussed in the MEIR, future development of the area would be consistent with the land uses designated for government and industrial with a renewable energy overlay. The area surrounding the Project site consists of agricultural land uses, dealerships and manufacturing. One single-family home is located approximately 0.25-mile east of the Project site.

While there is a residence located adjacent to the Project site, there are no established communities in the area. Furthermore, the zoning of the area consists of industrial operations. While the Project proposes a specific plan amendment and zone change from Light and Medium Industrial to Heavy Industrial, these would be consistent uses with the Specific Plan and larger Project site area, and therefore, the addition of the Project would not be an incompatible use. As such, the Proposed Project would not physically divide an established community. The Project would be consistent with the MEIR, would not result in any new impacts that were not previously analyzed, and no impact would occur.

- b) Cause a significant environmental impact due to a conflict with any land use plan, policy, or regulation adopted for the purpose of avoiding or mitigating an environmental effect?

**b) Consistent with the MEIR, Less than Significant Impact.** The Project would require submittal and approval of the CUP, Variance for height exceedance, and Tentative Tract Map, the approval of which would result in the Proposed Project to be compliant with the land use and zoning requirements. Furthermore, the existing land use and zoning of the Project site are compatible with industrial uses and other uses within the Specific Plan area. The Project is proposing industrial operations at an increased intensity, however, based on the results of the air quality and traffic analyses, the change in land uses would not result in a significant impact to these resources areas.

Additionally, as a result of the proposed changes, future heavy industrial uses as indicated in Table 2, Allowed Uses above, would now be able to be developed either with a CUP or as an allowed use. Although the newly allowed heavier industrial uses may have the potential to cause additional impacts as compared to the existing lighter industrial uses, the same standards and mitigation measures that the MEIR applied to those heavies uses would also be applied to these uses and parcels and therefore, as demonstrated throughout this IS/MND, impacts would remain less than significant. Similar to the MEIR, with the Specific Plan Amendment and Zone Change, all future projects shall be subject to County review and compliance with specific conditions of approval to ensure consistency with land use and development regulations. Therefore, impacts would be less than significant.

**XII MINERAL RESOURCES Would the project:**

- a) Result in the loss of availability of a known mineral resource that would be of value to the region and the residents of the state?
- b) Result in the loss of availability of a locally-important mineral resource recovery site delineated on a local general plan, specific plan or other land use plan?

**Summary of Impacts Identified in the MEIR:**

The MEIR noted that the County's mineral resources with the highest economic value, which are gold, gypsum, sand, gravel, lime, clay, and stone. Industrial materials are also readily available, including kyanite, mineral fillers (clay, limestone, sericite, mica, and tuff), salt, potash, calcium chloride, and manganese. Most of the active mining operations are in the desert areas of the County and no active mining operations exist within the project or nearby. Soils within the Mesquite Lake project are not known to possess any unique mineral value not typical of other similar lands throughout the irrigated portion of the County. The MEIR evaluated impacts to mineral resources within the Specific Plan area and found that with implementation of the Specific Plan, impacts to mineral resources would not occur.

**Impacts Related to the Proposed Project:**

- a) Result in the loss of availability of a known mineral resource that would be of value to the region and the residents of the state?
- b) Result in the loss of availability of a locally-important mineral resource recovery site delineated on a local general plan, specific plan or other land use plan?

**a) and b) Consistent with the MEIR, No Impact.** The Project site has not been evaluated by the California Department of Conservation for potential mineral resources onsite (DOC 2022d). However, as noted previously, the MEIR evaluated impacts to mineral resources within the Specific Plan area, including the Project site, and found that no impacts to mineral resources would occur.



	Potentially Significant Impact (PSI)	Less Than Significant With Mitigation Incorporated (LTSWMI)	Less Than Significant Impact (LTSI)	No Impact (NI)
<b>XIII NOISE</b> <i>Would the project result in:</i>				
a) Generation of a substantial temporary or permanent increase in ambient noise levels in the vicinity of the project in excess of standards established in the local general plan or noise ordinance, or applicable standards of other agencies?	<input type="checkbox"/>	<input type="checkbox"/>	<input checked="" type="checkbox"/>	<input type="checkbox"/>
b) Generation of excessive groundborne vibration or groundborne noise levels?	<input type="checkbox"/>	<input type="checkbox"/>	<input checked="" type="checkbox"/>	<input type="checkbox"/>
c) For a project located within the vicinity of a private airstrip or an airport land use plan or where such a plan has not been adopted, within two miles of a public airport or public use airport, would the project expose people residing or working in the project area to excessive noise levels?	<input type="checkbox"/>	<input type="checkbox"/>	<input type="checkbox"/>	<input checked="" type="checkbox"/>

**Summary of Impacts Identified in the MEIR:**

The MEIR included a discussion of resources that were found to have environmental effects found not to be significant per CEQA Guidelines Section 15128. The MEIR summarized that in general, there are few existing and no planned residential uses surrounding the Specific Plan area, and therefore, there would be no incompatibility between industrial noises and residences. The MEIR noted that for all zones within the Specific Plan, that industrial uses are allowed, provided that such facilities do not emit fumes, odor, dust, smoke, or gas beyond the confines of the property line within which their activity occurs, or produce significant levels of noise or vibration beyond the perimeter of the site. The MEIR concluded that the Specific Plan does not propose residential uses and only a few single family residences exist within or adjacent to the Specific Plan that could be potentially affected by noise of future industrial uses or traffic generated by the project, and therefore significant impacts would not occur.

**Impacts Related to the Proposed Project:**

A Noise Analysis was prepared by LDN, as provided in Appendix F. The analysis looked at ambient noise levels, and then evaluated both construction and operational impacts associated with the Project as discussed below. Based on the applicable noise regulations, the Project would have a significant noise impact if it would:

- Result in exposures of sensitive receptor during construction to the short-term noise levels (in Table 11 below)
- During Project operations, result in an increase of 5 dBA CNEL or greater

**Construction Noise**

Noise levels resulting from proposed construction activities were obtained from reports prepared by the FTA and the Federal Highway Administration (FHWA), satellite imagery from the site, and field data. Most of the project construction would be located within the western half of the project site approximately 0.5-miles or more away from the nearest sensitive receivers to the east. However, portions of the site construction would be as close as 0.25-miles. Construction noise levels were calculated at 0.25-miles from the nearest sensitive receiver. As shown on Table 10, construction noise levels would attenuate from 93 dBA at 50 feet from the source to 65 dBA at the closest residential receptor due to geometric spreading of sound energy. Therefore, all calculated noise levels would fall within the normally acceptable range of the guidance set forth in the County of Imperial General Plan Noise Element.

**Table 10: Construction Noise Levels**

Sensitive Receptor	Source Level @ 50-Foot (dBA)	Approximate Distance to Residential Receptor	Noise Reduction Due to Distance (dBA)	Resultant Noise Level at Sensitive Receptor (dBA)
Residence	93	0.25-miles east	-28	65
		County of Imperial Threshold		75
		<b>IMPACT?</b>		<b>NO</b>

**Operational Noise**

Primary noise sources at the railroad facility would include the transloading of commodities; water treatment, storage, and distribution; a grain elevator; the hay and grain export and container depot; and the fuel blending and transloading area and fueling station. The nearest sensitive property line to the operational noise sources, by distance and orientation, is the existing single-family home located approximately 0.25 mile

Potentially Significant Impact (PSI)      Less Than Significant With Mitigation Incorporated (LTSWMI)      Less Than Significant Impact (LTSI)      No Impact (NI)

east of the Project site. All other property lines are located further away, allowing a less restrictive noise standard or a higher noise level.

**Water Treatment**

The Project will include a water treatment, storage and distribution system that will satisfy potable water and firewater requirements. The system will receive water from the IID Dahlia Lateral 8 canal located along the southerly boundary of the Project. The treatment, storage and pump elements of the system will be located on an approximately 2-acre lot. The water treatment, storage and distribution system will likely be developed in phases with an initial phase having a storage capacity of approximately 180,000 gallons and a built-out storage capacity of up to 1.5 million gallons. Conversely, during initial site operations and prior to the need for a public water system, the Project may truck-in purified/potable water. A 1.5-million-gallon tank would be approximately 50 feet tall and approximately 100 feet in diameter. The Project would also have a raw water service connection to IID Dahlia Lateral 8 for industrial/process water.

The proposed water pump would generate a noise level of 45 dBA at 15 feet from the access hatch. The proposed transformer has an unshielded noise rating of less than 51 dBA at 5 feet (National Electric Manufacturers Association (NEMA)). Tested outdoor sound levels were provided by the manufacturer/supplier of a typical generator. The noise ratings provided indicate the generator will produce reduced noise levels of 75 dBA during weekly engine exercise and during normal operation when measured at 23-feet in all directions with the manufacturer's sound enclosure. Due to the noise level of the backup generator, the pump system and transformer would not cumulatively add to the overall noise levels. Therefore, the primary source of noise from the water treatment facility would be the backup generator.

As shown in Table 11, the noise levels would be below the 45 dBA Leq thresholds at the nearest single-family property line located an average of 3,300 feet to the east of the water treatment facility. Therefore, the water treatment facility activities follow the County's noise standards and no mitigation or impacts are anticipated.

**Table 11: Water Treatment Noise Levels**

Source	Noise Level @ 23 Feet (dBA)	Quantity <sup>1</sup>	Cumulative Noise Level (dBA)	Average Distance to Nearest Property Line (Feet)	Noise Reduction due to distance (dBA)	Resultant Noise Level @ Property Line (dBA)
Generator	75	1	75.0	3,300	-43.1	31.9
<sup>1</sup> Source: Project Site Plan						

**Transloading**

The primary source of noise from the transloading operations will be from trucks loading and unloading to and from the loop tracks that tie into the adjacent Union Pacific Railroad ROW. Transloading of goods will be associated with operations at the grain elevators, fuel blending, hay and grain export, produce/food export, and general commodities.

As shown in Table 12, trucks operating for a full hour on site at the same time the noise levels would be below the 45 dBA Leq thresholds at the nearest single-family property line located an average of 2,800 feet to the east of the transloading areas. Therefore, the truck activities follow the County's noise standards, and no mitigation or impacts are anticipated.

**Table 12: Transloading Noise Levels**

Source	Noise Level @ 23 Feet (dBA)	Quantity <sup>1</sup>	Cumulative Noise Level (dBA)	Average Distance to Nearest Property Line (Feet)	Noise Reduction due to distance (dBA)	Resultant Noise Level @ Property Line (dBA)
Trucks	59.2	16	71.2	2,800	-41.7	29.5
<sup>1</sup> Source: Project Site Plan						

- a) Generation of a substantial temporary or permanent increase in ambient noise levels in the vicinity of the project in excess of standards established in the local general plan or noise ordinance, or applicable standards of other agencies?

**a) Consistent with the MEIR; Less Than Significant Impact.** The Project does not propose residential uses and only a few single-family residences exist within or adjacent to the Project site that could be potentially affected by noise of future industrial

Potentially Significant Impact (PSI)      Less Than Significant With Mitigation Incorporated (LTSWMI)      Less Than Significant Impact (LTSI)      No Impact (NI)

uses or traffic generated by the Project. As discussed above, the Project would be consistent with the General Plan and would not exceed thresholds for either construction or operation related impacts. The Project would not result in a substantial temporary or permanent increase in ambient noise levels and therefore impacts would be less than significant.

- b) Generation of excessive groundborne vibration or groundborne noise levels?

**b) Consistent with the MEIR; Less Than Significant Impact.** While Imperial County has not yet adopted vibration criteria, the United States Department of Transportation Federal Transit Administration (FTA) provides criteria for acceptable levels of groundborne vibration for various types of special buildings that are sensitive to vibration. The FTA has determined vibration levels that would cause annoyance to a substantial number of people and potential damage to building structures. The FTA criterion for vibration induced structural damage is 0.20 in/sec for the peak particle velocity (PPV). Project construction activities would result in PPV levels below the FTA's criteria for vibration induced structural damage. The FTA criterion for infrequent vibration induced annoyance is 80 Vibration Velocity (VdB) for residential uses. Construction activities would generate levels of vibration that would not exceed the FTA criteria for nuisance for nearby residential uses. There are no vibration-sensitive uses located adjacent to the proposed construction. The nearest residential use is located over 0.25-miles from any construction activities. Table 13 lists the average vibration levels that could be experienced at adjacent land uses from the temporary construction activities at 100-feet. Project construction activities are located a minimum of 0.25-miles away, therefore, would not result in vibration induced structural damage or vibration induced annoyance to adjacent land uses. Vibration impacts would be less than significant.

**Table 13: Vibration Levels from Construction Activities**

Equipment	Approximate Velocity Level at 25 Feet (VdB)	Approximate RMS Velocity at 25 Feet (in/sec)	Approximate Velocity Level at 100 Feet (VdB)	Approximate RMS Velocity at 100 Feet (in/sec)
Small bulldozer	58	0.003	40.0	0.0004
Jackhammer	79	0.035	61.0	0.0044
Loaded trucks	86	0.076	68.0	0.0095
Large bulldozer	87	0.089	69.0	0.0111
		FTA Criteria	80	0.2
		<b>Significant Impact?</b>	<b>No</b>	<b>No</b>
<sup>1</sup> PPV at Distance D = PPVref x (25/D) <sup>1.5</sup>				

- c) For a project located within the vicinity of a private airstrip or an airport land use plan or where such a plan has not been adopted, within two miles of a public airport or public use airport, would the project expose people residing or working in the project area to excessive noise levels?

**c) Consistent with the MEIR; No Impact.** The nearest airport to the Project is the Imperial County Airport, which is approximately 3.4 miles to the southwest (Google 2023). Because the Project is not located near an airport or within an airport zone of influence, the Project would not expose people in the Project area to excessive noise levels. Therefore, no impact would occur.

**XIV POPULATION AND HOUSING** *Would the project:*

- a) Induce substantial unplanned population growth in an area, either directly (for example, by proposing new homes and business) or indirectly (for example, through extension of roads or other infrastructure)?
- b) Displace substantial numbers of existing people or housing, necessitating the construction of replacement housing elsewhere?

Potentially Significant Impact (PSI)	Less Than Significant With Mitigation Incorporated (LTSWMI)	Less Than Significant Impact (LTSI)	No Impact (NI)
--------------------------------------	---	-------------------------------------	----------------

**Summary of Impacts Identified in the MEIR:**

The MEIR noted that the Specific Plan does not propose residential uses and very few single-family residences are known to exist within the Specific Plan Area. In addition, the Specific Plan is primarily zoned for agricultural and industrial use and is not designated for residential development on the County General Plan. The Specific Plan could induce population growth through new employment opportunities; however, with the chronically high unemployment rate in the County, a population increase would not be required to meet the labor needs of projects within the Specific Plan. The MEIR concluded that with implementation of the Specific Plan, significant impacts to population and housing would not occur.

**Impacts Related to the Proposed Project:**

- a) Induce substantial unplanned population growth in an area, either directly (for example, by proposing new homes and business) or indirectly (for example, through extension of roads or other infrastructure)?

**a) Consistent with the MEIR, Less Than Significant Impact.** Similar to the MEIR, the Project does not propose residential uses and it is unlikely that the Proposed Project would induce substantial population growth. Also similar to the MEIR, the Project could induce population growth through new employment opportunities. The Project is expected to employ approximately 400 construction workers over the course of build-out, with as many as 200 workers on-site daily during construction once structures and buildings go vertical. Once operational, approximately 56 full-time employees are expected each day of the week during Project operations to cover all of the Project elements, with approximately 2 shifts per day (5am to 1pm and 11am to 7pm). However, as noted in the MEIR, there is a chronically high unemployment rate in the County. This high unemployment rate still exists today, with the current unemployment rate at 16.0 percent in September 2022 (EDD 2022). It is expected that a majority of the projected employment opportunities would be met via the local employment pool, which would not result in an increase in population.

Additionally, one of the overall goals for the Specific Plan is to support economic development within Imperial County and allow for heavy industrial development in an area that is away from urban conflicts and its cities through job creation in the employment sectors of manufacturing, fabrication, processing, wholesaling, transportation, and energy resource development; and create and preserve an area where a full range of industrial uses with moderate to high nuisance characteristics may locate. The proposed Project would help realize this goal within the Specific Plan area by creating job opportunities. Therefore, population growth impacts would be less than significant.

- b) Displace substantial numbers of existing people or housing, necessitating the construction of replacement housing elsewhere?

**b) Consistent with the MEIR, No Impact.** As discussed in the 2006 MEIR, no residential uses and very few single-family residences are known to exist within the Project site (County 2006). No housing units would be removed as part of the Project, and no persons would require replacement housing. Therefore, no impact to housing requiring the construction of replacement housing would occur.

**XV PUBLIC SERVICES**

- a) Would the project result in substantial adverse physical impacts associated with the provision of new or physically altered governmental facilities, need for new or physically altered governmental facilities, the construction of which could cause significant environmental impacts, in order to maintain acceptable service ratios, response times or other performance objectives for any of the public services:
- |                             |                          |                                     |                                     |                          |
|-----------------------------|--------------------------|-------------------------------------|-------------------------------------|--------------------------|
| 1) Fire Protection?         | <input type="checkbox"/> | <input checked="" type="checkbox"/> | <input type="checkbox"/>            | <input type="checkbox"/> |
| 2) Police Protection?       | <input type="checkbox"/> | <input type="checkbox"/>            | <input checked="" type="checkbox"/> | <input type="checkbox"/> |
| 3) Schools?                 | <input type="checkbox"/> | <input type="checkbox"/>            | <input checked="" type="checkbox"/> | <input type="checkbox"/> |
| 4) Parks?                   | <input type="checkbox"/> | <input type="checkbox"/>            | <input checked="" type="checkbox"/> | <input type="checkbox"/> |
| 5) Other Public Facilities? | <input type="checkbox"/> | <input type="checkbox"/>            | <input checked="" type="checkbox"/> | <input type="checkbox"/> |

**Summary of Impacts Identified in the MEIR:**



Potentially Significant Impact (PSI)	Less Than Significant With Mitigation Incorporated (LTSWMI)	Less Than Significant Impact (LTSI)	No Impact (NI)
--------------------------------------	---	-------------------------------------	----------------

The MEIR discussed the impacts of the Specific Plan with regards to public services in the Hazards and Hazardous Materials section of the MEIR. At the time of the preparation of the MEIR, the area generally lacked public services and utilities necessary to support the proposed project. The Specific Plan describes the need for a fire station in the southerly portion of the project area, which might also be suitable for use by County Sheriff personnel. The MEIR does state, however, that the lack of an adequate water delivery system for fire suppression is a significant impact that cannot be fully mitigated until a comprehensive program for installation of a system to deliver water to individual properties at pressure suitable for firefighting has been prepared and implemented. Nonetheless, the MEIR included mitigation measures to lessen significant impacts. The measures relevant to the proposed Project are as follows:

**Mitigation Measure 4.7.7:** The County Fire Chief shall monitor development of the Specific Plan to determine the need for construction and operation of an on-site fire station. This is expected to require dedication of an approximate 2- to 3-acre site within the Specific Plan to be used for the purpose of developing future emergency service facilities including possibly a combined police/fire station as needed. This facility shall be constructed and become operational at such time as required by the County Fire Chief.

**Mitigation Measure 4.7.8:** Prior to approval of a final map, grading plan, or building permit for any phase or unit of development within the Specific Plan, the applicant shall provide evidence to the Planning and Development Services Director that a determination has been made by the County Fire Department that an adequate system for delivery of an adequate supply of water for fire suppression, and other required equipment, alarms, and water connections, is to be provided to serve the project.

**Mitigation Measure 4.7.9:** Prior to issuance of a certificate of occupancy for any building within any phase or unit of development within the Specific Plan, the applicant shall provide evidence to the Planning and Development Services Director that the fire suppression system required by Mitigation Measure 4.7.8 has been installed to the County Fire Department's satisfaction and is operational.

Law enforcement services rely primarily on tax revenues and mitigation fees as provided in Municipal Code Section 4.36.070 et seq. The MEIR states that these revenue sources would offset the incremental increase in service caused by development of the Specific Plan.

The requirements for emergency medical response to the Specific Plan area would not be expected to be a significant impact. No residential uses are permitted within the Specific Plan other than caretaker/security residences and the handling of hazardous materials would be conducted in compliance with County and State regulations. In addition, businesses and manufacturing processes would be conducted in compliance with California Occupational Safety and Health Administration (Cal/OSHA) requirements and procedures enforced by the California Division of Occupational Safety and Health for workplace safety. Schools, Parks, and Other Public Facilities were not analyzed in the MEIR.

**Impacts Related to the Proposed Project:**

- a) Would the project result in substantial adverse physical impacts associated with the provision of new or physically altered governmental facilities, need for new or physically altered governmental facilities, the construction of which could cause significant environmental impacts, in order to maintain acceptable service ratios, response times or other performance objectives for any of the public services:

1) Fire Protection?

**1) Inconsistent with the MEIR, Less than Significant with Mitigation.** Fire Protection services are provided by the Imperial County Fire Department, which also provides emergency medical responses. The nearest fire station to the Proposed Project is Station 1, approximately 3.8 miles south of the Project site and approximately 12 minutes south of the Project site. Although the 2006 MEIR stated that the lack of an adequate water delivery system for fire suppression was a significant impact that could not be fully mitigated until a comprehensive program for installation of a system to deliver water to individual properties at pressure suitable for firefighting has been prepared and implemented, a centralized water treatment, storage and distribution system would be installed to provide fire water to the Project area. Water for fire protection would be purchased from IID and stored in an above ground storage tank in accordance with County Fire Department standards. The system will be designed in accordance with federal, state, and local fire codes, occupational health and safety regulations and other jurisdictional codes, requirements, and standard practices. The Project site would also include hydrants for fire suppression. Additionally, similar to the MEIR, the Project would implement mitigation measure 4.7.7 and 4.7.8, which will require the County Fire Chief evaluate the Project development to ensure adequate operation of fire emergency services and supply of water. Additionally, mitigation measure 4.7.9, requires that the prior to occupancy the fire suppression system be installed and operational.

Furthermore, the Imperial County Fire Department maintains mutual aid agreements with Brawley Fire Department and Imperial County Fire Department and completion of the Proposed Project would include payment of development fees that would support the fire department and other County services. With implementation of the above mitigation, and the project design features, impacts would be less than significant.

	Potentially Significant Impact (PSI)	Less Than Significant With Mitigation Incorporated (LTSWMI)	Less Than Significant Impact (LTSI)	No Impact (NI)
2) Police Protection?	<input type="checkbox"/>	<input type="checkbox"/>	<input checked="" type="checkbox"/>	<input type="checkbox"/>
<p><b>2) Consistent with the MEIR, Less Than Significant Impact.</b> Police services are provided by the Imperial County Sheriff Department, which would provide patrol units and emergency response to the Project site. The nearest Sheriff Station is located just over 5.5 miles northeast of the Project site. Law enforcement services primarily rely on tax revenue and mitigation fees, per Municipal Code Section 4.36.070 et seq. These revenue sources would offset the incremental increase in service that could be caused by Project development. Similar to fire protection mutual aid, additional mutual aid services for police would be provided by Brawley and El Centro. The Project would also be subject to development fees that would support County services. Impacts would be less than significant.</p>				
3) Schools?	<input type="checkbox"/>	<input type="checkbox"/>	<input checked="" type="checkbox"/>	<input type="checkbox"/>
<p><b>3) Less Than Significant Impact.</b> As previously described in Section IV, Population and Housing, it is expected that a majority of the projected employment opportunities would be met via the local employment pool, which would not result in an increase in population. The Project would not directly result in an increase in population and therefore, new students. Impacts would be less than significant.</p>				
4) Parks?	<input type="checkbox"/>	<input type="checkbox"/>	<input checked="" type="checkbox"/>	<input type="checkbox"/>
<p><b>4) Less Than Significant Impact.</b> As discussed in Section IV Population and Housing, the Project does not propose residential uses and it is unlikely that the Proposed Project would induce substantial population growth that would use parks. Furthermore, there are no parks or recreational areas within or in the vicinity of the Project site. Impacts would therefore be less than significant.</p>				
5) Other Public Facilities?	<input type="checkbox"/>	<input type="checkbox"/>	<input checked="" type="checkbox"/>	<input type="checkbox"/>
<p><b>5) Consistent with the MEIR, Less Than Significant Impact.</b> The Proposed Project is expected to pull from the local employment pool and not encourage relocation of workers from other locations. Similar to the MEIR, the proposed Project would not contain residential uses, and the handling of hazardous materials would be conducted in compliance with County and State regulations. Therefore, impacts on emergency services are expected to be less than significant. No other various public facilities are expected to be required or expanded to support the Project due to the use of employees within the Imperial Valley region. Additionally, the Proposed Project would be required to pay development fees that would support various County services. Impacts would be less than significant.</p>				

**XVI RECREATION: Would the project:**

- |  |                          |                          |                                     |                                     |
|--|--------------------------|--------------------------|-------------------------------------|-------------------------------------|
| a) Would the project increase the use of the existing neighborhood and regional parks or other recreational facilities such that substantial physical deterioration of the facility would occur or be accelerated? | <input type="checkbox"/> | <input type="checkbox"/> | <input type="checkbox"/>            | <input checked="" type="checkbox"/> |
| b) Does the project include recreational facilities or require the construction or expansion of recreational facilities which might have an adverse effect on the environment?                                     | <input type="checkbox"/> | <input type="checkbox"/> | <input checked="" type="checkbox"/> | <input type="checkbox"/>            |

**Summary of Impacts Identified in the MEIR:**

The MEIR included a discussion of resources that were found to have environmental effects found not to be significant per CEQA Guidelines Section 15128. The MEIR summarized that recreation sites within the Specific Plan Area would be limited to fallow farmlands that are periodically flooded during duck hunting season to be used by hunting clubs. However, implementation of the Specific Plan was not found to prevent the continued use of these lands during duck hunting season. Furthermore, it was noted that there are other adequate sites that may be used should these properties be converted for industrial use. Any future planned industrial uses would not require the expansion or construction of new recreational areas in other areas of the County. No parks or recreation areas were located within the vicinity of the Project site.

**Impacts Related to the Proposed Project:**

- |  |                          |                          |                          |                                     |
|--|--------------------------|--------------------------|--------------------------|-------------------------------------|
| a) Would the project increase the use of the existing neighborhood and regional parks or other recreational facilities such that substantial physical deterioration of the facility would occur or be accelerated? | <input type="checkbox"/> | <input type="checkbox"/> | <input type="checkbox"/> | <input checked="" type="checkbox"/> |
|--|--------------------------|--------------------------|--------------------------|-------------------------------------|

**a) Consistent with the MEIR; No Impact.** The Project proposes construction and operation of an industrial park, logistics centers for food and commodity imports and exports, and rail loop and ladder tracks to connect to the existing UPPR, and a fueling station. The Proposed Project would include an approximately 3-acre public park facility in honor of veterans that will be located east of and adjacent to the existing Memory Gardens Cemetery. The existing Memory Gardens Cemetery property lines will be adjusted for inclusion and the park and cemetery will be fenced from rest of the Project site. Access to the park (and cemetery) will be via the existing and historical access from SR 86. The proposed park will include memorial improvements, restrooms, hardscaped walkways and playground equipment.

The nearest existing park to the Proposed Project is Evans Park located approximately 3 miles south from the Proposed Project, driving distance. Increase uses of existing neighborhood and regional parks are typically a result of increased neighborhood populations that

	Potentially Significant Impact (PSI)	Less Than Significant With Mitigation Incorporated (LTSWMI)	Less Than Significant Impact (LTSI)	No Impact (NI)
--	--------------------------------------	---	-------------------------------------	----------------

come with new residential development. The Proposed Project would result in a temporary increase in population with the presence of construction workers. However, their presence would be temporary once the Project is completed and in operation. The Proposed Project would not involve development of new residences that would introduce new permanent populations to the area. Therefore, the Proposed Project would not increase the use of existing neighborhood and regional parks that could result in accelerated deterioration. Implementation of the Project would be consistent with the MEIR and would not result in any new impacts not previously analyzed. No impact would occur.

- b) Does the project include recreational facilities or require the construction or expansion of recreational facilities which might have an adverse effect on the environment?

**b) Consistent with the MEIR; Less than Significant Impact.** The Proposed Project includes a recreational facility (park) to the area. The proposed park will be installed within the existing cemetery property. Permitted uses within the Mesquite Lake Specific Plan includes parks and other recreational activities. Parks are permitted in MLI-1. Parks are also permitted in public, semi-public and institutional areas. The MEIR noted that any future development within the Specific Plan Area would not result in significant impacts to recreation, as there were no designated recreational areas within the immediate vicinity of the Specific Plan Area. The Project would not include the removal or impact of existing recreational facilities that would require expansion of such facilities. Implementation of the Project would be consistent with the MEIR and would not result in any new impacts not previously analyzed. Impacts therefore are less than significant.

**XVII TRANSPORTATION** *Would the project:*

- a) Conflict with a program plan, ordinance or policy addressing the circulation system, including transit, roadway, bicycle and pedestrian facilities?
- b) Would the project conflict or be inconsistent with the CEQA Guidelines section 15064.3, subdivision (b)?
- c) Substantially increases hazards due to a geometric design feature (e.g., sharp curves or dangerous intersections) or incompatible uses (e.g., farm equipment)?
- d) Result in inadequate emergency access?

**Summary of Impacts Identified in the MEIR:**

The MEIR included a Traffic Impacts Analysis (TIA) prepared by Linscott, Law, and Greenspan, Engineers (LLG). The TIA evaluated existing traffic, traffic with full build out of the Specific Plan (2010), and cumulative impacts (2025), which included full build out of the Specific Plan, and off-site planned and approved developments.

The MEIR noted that the volume from Specific Plan buildout would impact existing roads in the area which are generally not currently improved to adequately accommodate the volume of traffic. The level of traffic generation from full buildout of the Specific Plan would result in significant on- and offsite impacts. The MEIR included the following mitigation measures:

**Mitigation Measure 4.10.1:** Signalize the SR 86/Keystone intersection, provide a dedicated eastbound left-turn lane, and provide dedicated westbound left-turn, through, and right-turn lanes with an overlap phase. The existing southbound left-turn lane and northbound right-turn lane shall be lengthened.

**Mitigation Measure 4.10.2:** Signalize the SR 86/Harris Road intersection and provide dedicated left-turn lanes at all four approaches (i.e., northbound, southbound, eastbound, westbound).

**Mitigation Measure 4.10.3:** Provide dedicated eastbound and westbound left-turn, through and right-turn lanes at the SR 86/Worthington Road intersection; and provide a dedicated right-turn lane in the northbound direction and a shared through/right-turn lane in the southbound direction.

**Mitigation Measure 4.10.4:** Signalize the Dogwood Road/Keystone Road intersection and provide dedicated left-turn lanes at each approach (i.e., northbound, southbound, eastbound, westbound).

**Mitigation Measure 4.10.5:** Signalize the Dogwood Road/Harris Road intersection and provide dedicated left-turn lanes at each approach (i.e., northbound, southbound, eastbound, westbound).

Potentially Significant Impact (PSI)	Less Than Significant With Mitigation Incorporated (LTSWMI)	Less Than Significant Impact (LTSI)	No Impact (NI)
--------------------------------------	---	-------------------------------------	----------------

**Mitigation Measure 4.10.6:** Signalize the Dogwood Road/Worthington Road intersection and provide dedicated left-turn lanes at each approach (i.e., northbound, southbound, eastbound, westbound).

**Mitigation Measure 4.10.7:** Provide a dedicated eastbound right-turn lane with an overlap phase and dual northbound left-turn lanes at the SR 111/Keystone Road intersection. The addition of a second northbound left-turn lane will require widening Keystone Road between SR 111 and Old Highway 111 to accommodate the additional lane of traffic.

**Mitigation Measure 4.10.8:** Signalize the SR 111/Harris Road intersection and provide dedicated dual left-turn lanes and a right-turn lane for northbound traffic and a dedicated southbound right turn lane. A 4-foot shoulder shall be provided adjacent to the right turn lanes. The Harris Road intersections with Old Highway 111 and with the east side frontage road shall be realigned to provide increased separation from SR 111 to the satisfaction of Caltrans and the County Engineer.

**Mitigation Measure 4.10.9:** Widen Dogwood Road to four lanes (i.e., two lanes in each direction) from Keystone Road to Harris Road and from Harris Road to Worthington Road.

Mitigation Measures for Long Term Traffic/Circulation Impacts:

**Mitigation Measure 4.10.10:** Future street intersections or proposed project driveways on Keystone Road, Harris Road, and Dogwood Road shall be evaluated for signalization or other driveway intersection controls. Projected traffic volumes on these roads will require that streets and driveways be signalized and configured with dual inbound and outbound left-turn lanes, and dedicated right-turn lanes. If a signal is not provided, access shall be limited to right-turn only on Dogwood Road. Inbound left turns at the project driveways may be allowed on Keystone Road and Harris Road without signals, but outbound left-turns shall be prohibited at unsignalized intersections.

**Mitigation Measure 4.10.11:** If access rights to SR 86 exist or are allowed by Caltrans, proposed streets or private driveways shall be limited to right-turn only and dedicated northbound right-turn lanes shall be provided at all such intersections.

**Mitigation Measure 4.10.12:** All improvements to State-owned road segments and intersections shall provide operations at LOS C or better.

**Mitigation Measure 4.10.13:** All future development, including improvement to existing uses, shall contribute its fair share of the cost for improving off-site road segments and intersections significantly impacted by the Mesquite Lake Specific Plan. All fair share contributions on State-owned facilities shall be calculated using Caltrans' Guide for the Preparation of Traffic Impact Studies.

The MEIR only evaluated level of service (LOS) as the vehicle miles traveled (VMT) threshold was not added to the Appendix G CEQA thresholds until 2018, and analysis of VMT was not required until July 1, 2020.

**Impacts Related to the Proposed Project:**

Linscott, Law and Greenspan, Engineers (LLG) prepared a Transportation Impact Analysis, which included a Vehicle Miles Traveled (VMT) and Local Mobility Analysis (LMA) to assess the impacts to the street system as a result of the Green Valley Logistics Center Project, located in Imperial County (Appendix X).

**Project Access**

Access to the site will be provided via two driveways to SR 86. The north driveway will accommodate right-turn only egress and the south driveway will accommodate right-turn only ingress.

As a Project feature, the Project will require inbound and outbound heavy trucks to adhere to the following designated truck routes. The designated truck routes are intended to restrict heavy vehicles from turning across multiple lanes of oncoming traffic at unsignalized intersections on SR 111. The truck route requirements will be included as a Condition of Approval and will be enforced through on-site signage, off-site signage as appropriate, and in contracts with outside trucking agencies.

- When leaving the site, heavy trucks heading to the south / east via SR 111 will be required to make a right-turn out of the site onto SR 86, a right-turn from SR 86 to Keystone Road, a right-turn from Keystone Road to Dogwood Road, a left-turn from Dogwood Road onto Worthington Road, and a right-turn at the signalized intersection of Worthington Road and SR 111.
- Inbound trucks coming from the south / east via SR 111 will be required to make a left-turn at the signalized intersection of Worthington Road and SR 111, a right-turn onto Dogwood Road from Worthington Road, a left-turn onto Harris Road from Dogwood Road, a right-turn onto SR 86 from Harris Road, and a right-turn into the site.

**Project Traffic**

Project trips consist of vehicular trips on the street system, which begin or end at the Project site and are generated by the proposed development.



Potentially Significant Impact (PSI)	Less Than Significant With Mitigation Incorporated (LTSWMI)	Less Than Significant Impact (LTSI)	No Impact (NI)
--------------------------------------	---	-------------------------------------	----------------

Trip generation estimates for the Project are based on information provided by the applicant. The site will be developed incrementally over time and therefore the Project's initial trips will be significantly less than the Project buildout traffic volumes analyzed in this traffic report.

The traffic generated by the Project will consist of several unique trip types as described below.

Project traffic generation was calculated for each trip type as shown in Table 14. As seen in Table 14, the Project is calculated to generate a total of 979 ADT, with 42 inbound / 31 outbound trips during the AM peak hour, and 31 inbound / 42 outbound trips during the PM peak hour. The volumes include a passenger car equivalence factor (PCE), as discussed below.

- **Employee Trips:** At Project buildout, a total of 56 on-site employees are expected each day. The majority of the employees are expected to drive alone in their own vehicle (i.e., not carpool). 9% of the on-site employees (5 employees total) were assumed to carpool based on data provided in the Imperial County Transportation Commission Regional Active Transportation Plan. A trip rate of 2.1 ADT per worker vehicle was assumed to account for the trips to and from the Project site as well as the occasional mid-workday errand. Based on the location of the site, the provision of on-site services, and the nature of the Project, mid-workday trips are expected to be sporadic.

To estimate the peak hour employee trips, two-shifts per day (5AM to 1PM, and 11AM to 7 PM) was assumed. Employees working either of these shifts would avoid the 7AM to 9AM morning commuter peak hour and the 4PM to 6PM afternoon commuter peak hour. Nevertheless, in order to provide a conservative analysis, 10% of the total employee ADT were assumed to enter the site (traveling inbound) during the AM peak, and 10% of the total employee ADT were assumed to exit the site (traveling outbound) during the PM peak.

- **Heavy-Duty Truck Trips:** At Project buildout, a total of 218 heavy-duty trucks are expected to access the site each day (53 grain elevator trucks, 33 fuel trucks, 41 railed-in products export trucks, and 91 trucking only trucks). Heavy-duty trucks are assumed to access the site consistently between the hours of 5AM and 7PM (approximately 16 heavy vehicles per hour for 14-hours). A Passenger Car Equivalence (PCE) of 2.0 was applied to account for the diminished performance characteristics of heavy trucks in traffic flow (as compared to passenger vehicles) based on data contained in the Highway Capacity Manual (HCM).

**Table 14: Project Trip Generation**

Number and Type of Trips	Daily Trips			AM Peak Hour (w/PCE)			PM Peak Hour (w/PCE) <sup>d</sup>		
	ADT <sup>a</sup>	PCE <sup>b</sup>	PCE Adjusted ADT	In	Out	Total	In	Out	Total
Phase 1									
20 Worker Vehicles	42	1.0	42	4	0	4	0	4	4
48 Grain Elevator Trucks	96	2.0	192	7	7	14	7	7	14
24 Fuel trucks	48	2.0	96	3	3	6	3	3	6
8 Railed-in Products Export Trucks	16	2.0	32	1	1	2	1	1	2
20 Trucking Only Trucks	40	2.0	80	3	3	6	3	3	6
<b>Phase 1 Subtotal</b>	<b>242</b>	-	<b>442</b>	<b>18</b>	<b>14</b>	<b>32</b>	<b>14</b>	<b>18</b>	<b>32</b>
Phase 2									
31 Worker Vehicles <sup>c</sup>	65	1.0	65	7	0	7	0	7	7
5 Grain Elevator Trucks	10	2.0	20	1	1	2	1	1	2
9 Fuel trucks	18	2.0	36	1	1	2	1	1	2
33 Railed-in Products Export Trucks	66	2.0	132	5	5	10	5	5	10

Potentially Significant Impact (PSI)      Less Than Significant With Mitigation Incorporated (LTSWMI)      Less Than Significant Impact (LTSI)      No Impact (NI)

Number and Type of Trips	Daily Trips			AM Peak Hour (w/PCE)			PM Peak Hour (w/PCE) <sup>d</sup>		
	ADT <sup>a</sup>	PCE <sup>b</sup>	PCE Adjusted ADT	In	Out	Total	In	Out	Total
71 Trucking Only Trucks	142	2.0	284	10	10	20	10	10	20
<b>Phase 2 Subtotal</b>	<b>301</b>	<b>-</b>	<b>537</b>	<b>24</b>	<b>17</b>	<b>41</b>	<b>17</b>	<b>24</b>	<b>41</b>
<b>Total Trips:</b>	<b>543</b>	<b>-</b>	<b>979</b>	<b>42</b>	<b>31</b>	<b>73</b>	<b>31</b>	<b>42</b>	<b>73</b>

**Footnotes:**

- a. Average Daily Trips
- b. Passenger Car Equivalent. Based on the *Highway Capacity Manual*, a Passenger Car Equivalent (PCE) factor of 2.0 was applied to the Project's heavy-truck trips.
- c. A total of 56 on-site employees are expected each day at Project buildout. Based on data provided in the *Imperial County Transportation Commission Regional Active Transportation Plan*, February 2022, 9% of the on-site employees (5 people total) were assumed to carpool with other employees. A trip rate of 2.1 ADT per worker vehicle was assumed to account for the trips to and from the Project site as well as the occasional mid-workday errand. Based on the location of the site, the provision of on-site services, and the nature of the Project, mid-workday trips are expected to be very sporadic.
- d. Heavy-duty trucks are assumed to access the site consistently between the hours of 5AM and 7PM (approximately 16 heavy vehicles per hour for 14-hours at Project buildout).

**Capacity Analysis**

The following section presents the analysis of the study area intersections under Opening Year conditions. As noted previously, the site will be developed incrementally over time and therefore the Project's Opening Year trips will be significantly less than the Project buildout traffic volumes analyzed in this traffic report.

**Opening Year with Project Conditions**

Table 15 summarizes the Opening Year with Project intersection operations. As shown in Table 15, the study intersections are calculated to continue to operate acceptably at LOS C or better, with the exception of the following:

- Harris Road / SR-86 is calculated to continue to operate at LOS D during the AM and PM peak hours. A substantial effect is not calculated at this intersection since the Project-related increase in delay does not exceed the substantial effect threshold maximum of 2.0 seconds.
- Harris Road / SR-111 is calculated to continue to operate at LOS E during the AM and LOS F during the PM peak hours. A substantial effect is not calculated at this intersection since the Project-related increase in delay does not exceed the substantial effect threshold maximum of 2.0 seconds.
- Worthington Road / SR-86 is calculated to continue to operate at LOS D during the AM and PM peak hours. A substantial effect is not calculated at this intersection since the Project related increase in delay does not exceed the substantial effect threshold maximum of 2.0 seconds.

**Table 15: Opening Year Intersection Operations**

Intersection	Control Type	Movement/ Approach	Peak Hour	Opening Year		Opening Year + Project		Δe
				Delay <sup>a</sup>	LOS <sup>b</sup>	Delay <sup>a</sup>	LOS <sup>b</sup>	
1. Keystone Road / SR 86	Signal	Overall	AM	17.6	B	18.2	B	0.6
			PM	18.7	B	19.2	B	0.5

				Potentially Significant Impact (PSI)	Less Than Significant With Mitigation Incorporated (LTSWMI)	Less Than Significant Impact (LTSI)	No Impact (NI)	
2. Keystone Road / Dogwood Rd	AWSC <sup>d</sup>	Overall	AM PM	9.1 11.4	A B	9.3 11.9	A B	0.2 0.5
3. Keystone Road / SR 111	Signal	Overall	AM	15.2	B	15.6	B	0.4
			PM	14.8	B	14.9	B	0.1
4. SR 86 / N. Project Driveway	MSSC <sup>c</sup>	Worst-Case	AM PM	- -	- -	10.5 10.4	B B	- -
5. SR 86 / S. Project Driveway	MSSC <sup>c</sup>	Worst-Case	AM PM	- -	- -	0.0 0.0	A A	- -
6. Harris Road / SR 86	MSSC <sup>c</sup>	Worst-Case	AM	31.3	D	31.5	D	0.2
			PM	33.4	D	33.4	D	0.0
7. Harris Road / Dogwood Road	MSSC <sup>c</sup>	Worst-Case	AM PM	13.5 14.4	B B	14.8 15.8	B C	1.3 1.4
8. Harris Road / SR 111	MSSC <sup>c</sup>	Worst-Case	AM	43.1	E	44.0	E	0.9
			PM	50.3	F	50.3	F	0.0
9. Worthington Road / SR 86	Signal	Overall	AM	44.5	D	44.5	D	0.0
			PM	48.9	D	49.4	D	0.5
10. Worthington Road / Dogwood Road	AWSC <sup>d</sup>	Overall	AM PM	13.7 12.4	B B	14.2 12.6	B B	0.5 0.2
11. Worthington Road / SR 111	Signal	Overall	AM PM	19.7 12.2	B B	19.7 13.0	B B	0.0 0.8

### VMT Assessment

#### Heavy Vehicles

Per OPR guidelines, "vehicle miles traveled" refers to the amount and distance of automobile travel attributable to a project. Here the term "automobile" refers to on-road passenger vehicles, specifically cars and light trucks. VMT does not include trips from heavy trucks. Therefore, the trips generated by the Project's heavy-duty trucks are excluded from VMT analysis.

#### Employee Passenger Vehicles

The Project's employee passenger vehicles are calculated to generate 107 ADT, as shown in Table 14. Therefore, the employee component of the Project can be considered a "small project", assumed to cause a less-than significant transportation impact per OPR guidelines.

#### Local Mobility Analysis

The Project is not calculated to substantially affect any of the study intersections, and therefore no off-site improvements are required. It should be noted that the results presented in this study are dependent on Project related heavy truck trips adhering to the Project's truck route requirements summarized below:

As a Project feature, the Project will require inbound and outbound heavy trucks to adhere to the following designated truck routes. The designated truck routes are intended to restrict heavy vehicles from turning across multiple lanes of oncoming traffic at unsignalized intersections on. The truck route requirements will be included as a Condition of Approval and will be enforced through on-site signage, off-site signage as appropriate, and in contracts with outside trucking agencies.

•When leaving the site, heavy trucks heading to the south / east via SR 111 will be required to make a right-turn out of the site onto SR 86, a right-turn from SR 86 to Keystone Road, a right-turn from Keystone Road to Dogwood Road, a left-turn from Dogwood Road onto Worthington Road, and a right-turn at the signalized intersection of Worthington Road and SR 111.

	Potentially Significant Impact (PSI)	Less Than Significant With Mitigation Incorporated (LTSWMI)	Less Than Significant Impact (LTSI)	No Impact (NI)
--	--------------------------------------	---	-------------------------------------	----------------

-Inbound trucks coming from the south / east via SR 111 will be required to make a left-turn at the signalized intersection of Worthington Road and SR 111, a right-turn onto Dogwood Road from Worthington Road, a left-turn onto Harris Road from Dogwood Road, a right-turn onto SR 86 from Harris Road, and a right-turn into the site.

a) Conflict with a program plan, ordinance or policy addressing the circulation system, including transit, roadway, bicycle and pedestrian facilities?

b) Would the project conflict or be inconsistent with the CEQA Guidelines section 15064.3, subdivision (b)?

**a) and b) Less Than Significant.** As discussed above, the Project's employee passenger vehicles are calculated to generate 107 ADT, which is under the threshold of 110 ADT per the OPR Guidelines. Therefore, the employee component of the Project can be considered a "small project", assumed to cause a less-than significant transportation impact.

c) Substantially increases hazards due to a geometric design feature (e.g., sharp curves or dangerous intersections) or incompatible uses (e.g., farm equipment)?

**c) Consistent with the MEIR; Less Than Significant.** Impacts associated with Project conditions would result in an impact at Worthington Road / SR 86 intersection, Harris Road / SR 111, and Harris Road / SR 86, where the worst-case minor street left turn movement is calculated to operate at LOS E during the AM peak hour and LOS F during the PM peak hour. In order to avoid the potential impacts at these intersections, the following Project design features will be implemented:

- When leaving the site, heavy trucks heading to the south / east via SR 111 will be required to make a right-turn out of the site onto SR 86, a right-turn from SR 86 to Keystone Road, a right-turn from Keystone Road to Dogwood Road, a left-turn from Dogwood Road onto Worthington Road, and a right-turn at the signalized intersection of Worthington Road and SR 111.
- Inbound trucks coming from the south / east via SR 111 will be required to make a left-turn at the signalized intersection of Worthington Road and SR 111, a right-turn onto Dogwood Road from Worthington Road, a left-turn onto Harris Road from Dogwood Road, a right-turn onto SR 86 from Harris Road, and a right-turn into the site.

Implementation of the above project design features will result in less than significant impacts associated with roadway design.

d) Result in inadequate emergency access?

**d) Consistent with the MEIR; Less than Significant Impact.** Temporary or single-lane closure of some roadways may occur during the transport of oversized equipment or construction activities. Road closures would be coordinated with County Public Works, the County Sheriff, and ICFD prior to closure, and would be scheduled to occur during off-peak commute hours. The Project's construction and operational activities would be in compliance with the Imperial County Emergency Operations Plan (EOP) and Multi-Jurisdiction Hazard Mitigation Plan (MJHMP) and would not physically interfere with the execution of the policies and procedures in these plans (County 2015b; 2021a). Access roads may be additionally compacted to 90 percent or greater, as required, to support construction and emergency vehicles. Certain access roads may also require the use of aggregate to meet emergency access requirements. Therefore, the Project would not result in inadequate emergency access and impacts would be less than significant.

**XVIII TRIBAL CULTURAL RESOURCES**

a) Would the project cause a substantial adverse change in the significance of a tribal cultural resource, defined in Public Resources Code Section 21074 as either a site, feature, place, cultural landscape that is geographically defined in terms of the size and scope of the landscape, sacred place or object with cultural value to a California Native American tribe, and that is:

i. Listed or eligible for listing in the California Register of Historical Resources, or in a local register of historical resources as define in Public Resources Code Section 5020.1(k), or

(ii) A resource determined by the lead agency, in its



Potentially Significant Impact (PSI)	Less Than Significant With Mitigation Incorporated (LTSWM)	Less Than Significant Impact (LTSI)	No Impact (NI)
--------------------------------------	--	-------------------------------------	----------------

discretion and supported by substantial evidence, to be significant pursuant to criteria set forth in subdivision (c) of Public Resources Code Section 5024.1. In applying the criteria set forth in subdivision (c) of Public Resource Code Section 5024.1, the lead agency shall consider the significance of the resource to a California Native American Tribe.

California Assembly Bill 52 (AB 52) was enacted in 2014 (Chapter 532, Statutes of 2014) and became effective within CEQA on January 1, 2015. Per California Public Resources Code § 21080.3.1 lead agencies are required to notify formally requesting tribes of proposed projects located within their traditional use area. Pursuant to Government Codes §65352.3 and §65352.4 SB 18 requires local governments to consult with California Native American tribes identified by the Native American Heritage Commission (NAHC) for the purpose of avoiding, protecting, and/or mitigating impacts to cultural places when creating or amending General Plans, Specific Plans and Community Plans. The principal objective of SB 18 is to preserve and protect cultural places of California Native Americans. SB 18 is unique in that it requires local governments to involve California Native Americans in early stages of land use planning, extends to both public and private lands, and includes both federally recognized and non-federally recognized tribes.

**Summary of Impacts Identified in the MEIR:**

Since AB 52 and SB 18 were not enacted at the time the MEIR was approved. The MEIR states that development within the Specific Plan would have the potential to impact Late Prehistoric archaeological materials in areas associated with lower elevation recessional shorelines of Lake Cahuilla; which include the Project site.

**Impacts Related to the Proposed Project:**

On August 12, 2022, Chambers Group requested a Sacred Lands File (SLF) records search from the Native American Heritage Commission (NAHC). The purpose of the request is to determine if any sacred lands or other resources have been recorded within the Project site or adjacent areas. The results of the SLF search, provided by the NAHC on October 18, 2022, were positive, indicated the area could contain Tribal Cultural Resources.

SB 18 letters are required to be sent to all Tribes listed on the NAHC list. AB 52 letters are required to be sent Tribes who request to consult with the County. SB 18 letters were sent to the following Tribes and AB 52 letters were also sent to the bolded Tribes. All letters were sent on August 29, 2022, with one late SB 18 letter being sent on October 18, 2022. Responses for SB 18 were due by November 28, 2022 and January 16, 2023 respectively, and AB 52 responses were due by September 28, 2022.

- Augustine Band of Cahuilla Mission Indians
- Barona Group of the Capitan Grande
- **Campo Band of Diegueño Mission Indians**
- Chemehuevi Reservation
- Cocopah Indian Tribe
- Colorado River Indian Tribe
- Ewiiapaayp Band of Kumeyaay Indians
- Ewiiapaayp Tribal Office
- Iipay Nation of Santa Ysabel
- Inaja-Cosmit Band of Indians
- Inter-Tribal Cultural Resource Protection Council
- Jamul Indian Village
- Kwaaymii Laguna Band of Mission Indians
- La Posta Band of Diegueño Mission Indians
- Manzanita Band of Kumeyaay Nation
- Mesa Grande Band of Diegueño Mission Indians
- NAHC
- **Quechan Tribe of the Fort Yuma Reservation**
- San Pasqual Band of Diegueno Mission Indians
- Sycuan Band of the Kumeyaay Nation
- Torres-Martinez Desert Cahuilla Indians
- **Torres-Martinez Indian Tribe**
- Viejas Band of Kumeyaay Indians

As of January 17, 2023, the Quechan Tribe of the Fort Yuma Reservation was the only Tribe to respond, noting that they have no comments on the Project.

- a) Would the project cause a substantial adverse change in the significance of a tribal cultural resource, defined in Public Resources Code Section 21074 as either a site, feature, place, cultural landscape that is geographically defined in terms of the size and scope of the landscape, sacred place or object with cultural value to a California Native American tribe, and that is:

(i) Listed or eligible for listing in the California Register of

	Potentially Significant Impact (PSI)	Less Than Significant With Mitigation Incorporated (LTSWMI)	Less Than Significant Impact (LTSI)	No Impact (NI)
Historical Resources, or in a local register of historical resources as define in Public Resources Code Section 5020.1(k), or				
(ii) A resource determined by the lead agency, in its discretion and supported by substantial evidence, to be significant pursuant to criteria set forth in subdivision (c) of Public Resources Code Section 5024.1. In applying the criteria set forth in subdivision (c) of Public Resource Code Section 5024.1, the lead agency shall consider the significance of the resource to a California Native American Tribe.	<input type="checkbox"/>	<input checked="" type="checkbox"/>	<input type="checkbox"/>	<input type="checkbox"/>

**a) i) and ii) Less Than Significant with Mitigation.** As discussed above, SB 18 and AB 52 consultation were conducted by the County, and the Quechan Tribe of the Fort Yuma Reservation, responded noting that they had no concerns on the Project. No other Tribes responded during the consultation process. Nonetheless, a Cultural Resources Site visit was conducted by Chambers Group. Chambers Group concluded that while surface manifestations of cultural resources were not observed during the previous cultural resources study in support of the MEIR, and the current site visit, it should be noted that the landscape has been under historic-period use and settlement. This historic utilization may have resulted in unrecognized buried features such as footings and foundations or refuse area such as trash pits or outhouses. Similarly, ethnographic data and historic-period maps indicate that Native American groups such as the Kamia occupied and utilized major and minor drainages within the Salton Basin, as is documented on the 1856 General Land Office map, which depicted an "Indian Village" in the northeast quarter of Section 36 (Township 14S, Range 14E). The understanding that the area is important to Native American groups is further supported by the positive NAHC SLF records search results. However, the Project would implement MEIR Mitigation Measures 4.6.1 and 4.6.2, the former of which notes that if any unanticipated discovery of potential cultural resources are encountered during the Project, that proper protocols would be implemented. With implementation of these mitigation measures, impacts would remain less than significant.

**XIX UTILITIES AND SERVICE SYSTEMS** *Would the project:*

a) Require or result in the relocation or construction of new or expanded water, wastewater treatment or stormwater drainage, electric power, natural gas, or telecommunications facilities, the construction of which could cause significant environmental effects?	<input type="checkbox"/>	<input checked="" type="checkbox"/>	<input type="checkbox"/>	<input type="checkbox"/>
b) Have sufficient water supplies available to serve the project from existing and reasonably foreseeable future development during normal, dry and multiple dry years?	<input type="checkbox"/>	<input checked="" type="checkbox"/>	<input type="checkbox"/>	<input type="checkbox"/>
c) Result in a determination by the wastewater treatment provider which serves or may serve the project that it has adequate capacity to serve the project's projected demand in addition to the provider's existing commitments?	<input type="checkbox"/>	<input checked="" type="checkbox"/>	<input type="checkbox"/>	<input type="checkbox"/>
d) Generate solid waste in excess of State or local standards, or in excess of the capacity of local infrastructure, or otherwise impair the attainment of solid waste reduction goals?	<input type="checkbox"/>	<input checked="" type="checkbox"/>	<input type="checkbox"/>	<input type="checkbox"/>
e) Comply with federal, state, and local management and reduction statutes and regulations related to solid waste?	<input type="checkbox"/>	<input checked="" type="checkbox"/>	<input type="checkbox"/>	<input type="checkbox"/>

**Summary of Impacts Identified in the MEIR:**

The MEIR evaluated public services and utilities for the entire specific plan area. The MEIR evaluated impacts to electrical service, water service, drainage systems, wastewater treatment, solid waste disposal, other facilities including natural gas and telecommunications, and other essential services which included police, fire and emergency which are evaluated further in Section V Public Services.

The MEIR concluded that there would be adequate services and infrastructure for solid waste, natural gas and telecommunication facilities. Additionally, development within the specific plan area was expected to result in an increase in recycling and a net reduction in solid waste disposal and energy use in the County. The MEIR concluded that fully accomplishing the land use objectives would not be possible until a public agency was able to establish, accomplish and operate the necessary infrastructures within the specific plan area. The MEIR provided general mitigation for public services and utilities as follows:

**Mitigation Measure 4.9.1:** The County of Imperial and its Departments shall review all final maps, grading plans, building permits, use permits, and other applications for development of property within the Specific Plan and shall determine whether adequate public service improvements

Potentially Significant Impact (PSI)	Less Than Significant With Mitigation Incorporated (LTSWMI)	Less Than Significant Impact (LTSI)	No Impact (NI)
--------------------------------------	---	-------------------------------------	----------------

are provided or planned to accomplish the long-term land use objectives of the Mesquite Lake Specific Plan. While individual development may be allowed to proceed, the County shall determine the need for appropriate fair-share contributions, by fee or facility construction, to be required of any applicant. In addition, the County may require development agreements from project applicants to ensure participation in the formation and funding of a CFD or other public agency to accomplish the construction and operation of the required infrastructure improvements identified in the Specific Plan. When deemed necessary by the County, further development shall be denied pending establishment of a CFD or other public agency.

**Electrical Services**

Electrical power to the specific plan area is supplied by IID Energy from its local power generating resources and as a member of the Southern California Public Power Authority that brings electrical power from Arizona, New Mexico, Utah, and Nevada to serve its member agencies. The MEIR concluded that adequate electrical services could be provided by IID on site with the following mitigation:

**Mitigation Measure 4.9.2:** Prior to issuance of any building permit for any new building within the project, the building permit applicant shall provide evidence from IID Energy that adequate electrical service exists for the project or that required new facilities would be available prior to issuance of a certificate of occupancy for the building.

**Water Service**

Water is provided by IID from the Colorado River via the All-American Canal. The specific plan area is served from the Rose Canal, which bisects the specific plan area west of Dogwood Road and also via laterals from the Central Main Canal west of SR 86 and the Redwood Canal east of SR 111. The specific plan area is not within the service area of any water treatment plant, the nearest being the City of Imperial plant approximately 3 miles to the southwest. Raw water from IID can also be used for many industrial processes. The Specific Plan estimated that industrial uses typically require 1,250 to 2,500 gallons per day (GPD) per acre and noted requirements under SB 610. The MEIR concluded that water treatment, storage, pumping, and distribution systems would need to be developed throughout the specific plan area, not only to supply water to future businesses but also to ensure that water is available at sufficient pressure for firefighting requirements. The MEIR included the following mitigation:

**Mitigation Measure 4.9.3:** Prior to issuance of any building permit for any new building within the project, the building permit applicant shall provide evidence from IID that water service exists for the project, including for irrigation of landscape areas and dust control, and shall provide facilities for on-site treatment of raw water or for storage and distribution of delivered filtered water for hand washing and other sanitary requirements. All facilities required for adequate water service shall be installed and in working order prior to issuance of a certificate of occupancy for the building. Mitigation Measure 4.9.1 shall also be implemented to ensure to ensure participation in the formation and funding of a CFD or other public agency to accomplish the construction and operation of the required infrastructure improvements identified in the Specific Plan.

**Drainage Systems**

The MEIR noted that existing IID drainage systems in the project area do not have sufficient capacity for stormwater drainage and retention basins will need to be developed or be available for use by all Mesquite Lake non-agricultural projects. The MEIR offered the following mitigation to ensure impacts would remain less than significant:

**Mitigation Measure 4.9.4:** Prior to issuance of any building permit for any new building within the project, the building permit applicant shall provide evidence satisfactory to the Planning and Development Services Director that an adequate stormwater retention system exists for the project or that required new facilities will be available prior to issuance of a certificate of occupancy for the building. All new or expanded stormwater retention facilities shall be designed and constructed in accordance with a hydrology report prepared by a registered civil engineer and approved by the County Engineer, Planning and Development Services Director, and IID as adequate to accommodate stormwater runoff and disposal. Mitigation Measure 4.9.1 shall also be implemented to ensure participation in the formation and funding of a CFD or other public agency to accomplish the construction and operation of the required infrastructure improvements identified in the Specific Plan.

**Wastewater Treatment**

No wastewater treatment is available in the project area; the nearest treatment plant is in the City of Imperial approximately 1.8 miles to the south, which would require a pump station and force main, as well as an agreement from the city of Imperial to provide service to the project. Another alternative would be a future gravity line via Dogwood Road to Brawley approximately 4 miles to the north, which would also require an agreement with the City of Brawley. Evaporation ponds for industrial process water may also be required for some uses. The MEIR offered the following mitigation to ensure impacts would remain less than significant:

**Mitigation Measure 4.9.5:** Prior to issuance of any building permit for any new building within the project, the building permit applicant shall provide evidence that an adequate system for wastewater disposal and, if required, for industrial process water evaporation, exists for the project or will be constructed and available for use upon completion of the building. All facilities required for adequate wastewater disposal and process water evaporation shall be installed and in working order prior to issuance of a certificate of occupancy for the building. Mitigation Measure 4.9.1 shall also be implemented to ensure participation in the formation and funding of a CFD or other public agency to accomplish the construction and operation of the required infrastructure improvements identified in the Specific Plan.

**Solid Waste Disposal**

Potentially Significant Impact (PSI)	Less Than Significant With Mitigation Incorporated (LTSWMI)	Less Than Significant Impact (LTSI)	No Impact (NI)
--------------------------------------	---	-------------------------------------	----------------

The MEIR found that there are adequate services and infrastructure for solid waste disposal. The Allied Imperial Landfill accepts Class III (municipal) waste at its facility located approximately 1 mile south of the project on SR 111. Class II (special) waste is accepted at the Desert Valley Company disposal facility and storage site located northwest of Westmorland. A Class III (hazardous) waste facility is operated by Clean Harbors at a site west of Westmorland. Recycling facilities are limited to privately owned and operated drop-off centers.

In addition to regulation of facilities that handle hazardous materials, the California Integrated Waste Management Board (CIWMB) established procedures to implement the requirements of the California Public Resources Code for solid waste facilities. This would include a solid waste transfer or processing station, composting facility, transformation facility, and disposal facility. The following mitigation measures were included in the MEIR to ensure impacts remain less than significant.

**Mitigation Measure 4.9.6:** Prior to approval of final maps for each phase or unit of development within the specific plan area, a waste management plan shall be prepared in accordance with the County's Integrated Waste Management Plan and approved by the Planning and Development Services Director and the County Engineer. The plan shall include, but shall not be limited to, an assessment of the type and quantity of waste materials expected to enter the waste stream; source and separation techniques and on-site storage of separated materials; methods of transport and destination of waste materials; and, where economically feasible, implementation of buy-recycled programs.

Solid waste management measures were also discussed under the Hazards and Hazardous Materials section in the MEIR summarized below:

**Mitigation Measure 4.7.6:** For any project determined by the Planning and Development Services Director to require County Environmental Health and Safety / Local Enforcement Agency (EHS/LEA) approval under procedures established by the CIWMB, and prior to approval of a final map, grading plan, or building permit for any for such project, the applicant shall provide evidence to the Planning and Development Services Director that (1) a determination has been made by the County EHS/LEA on the need for project approval under procedures established by the CIWMB for compliance with the California Public Resources Code for solid waste facilities including a solid waste transfer or processing station, composting facility, transformation facility, and/or disposal facility; and if applicable to the project, (2) the property has been designated on the County NDFE and all local, state, and federal requirements for operation of a solid waste facility have been satisfied, including the requirement for issuance of a Solid Waste Facilities Permit by the LEA and in compliance with the County's Integrated Waste Management Plan.

**Impacts Related to the Proposed Project:**

- a) Require or result in the relocation or construction of new or expanded water, wastewater treatment or stormwater drainage, electric power, natural gas, or telecommunications facilities, the construction of which could cause significant environmental effects?

**a) Consistent with the MEIR, Less than Significant Impact with Mitigation.** The Proposed Project would require new connections for utilities to conduct their operations. The MEIR identified that there are existing services and infrastructure that would be able to support future development such as electric, water, solid waste, natural gas and telecommunications. Section E of the Project Summary discusses the proposed uses and sources of the utilities on the Project site.

Mitigation measure 4.9.1 would be required to be implemented by the Project to ensure all public service improvements can be adequately provided by all utility providers. A discussion of each utility and service system is detailed below:

**Water**

The proposed Project would require 180 AFY of water or a net decrease of 450 AFY when compared to the Project area's historical annual water consumption. The proposed Project would receive water from IID directly to an on-site water treatment facility, and would treat the water for uses throughout the Project site. Alternatively, the proposed Project may use smaller non-public water treatment systems to cover on-site operational scenarios of less than 25 employees. Similar to other Projects in the MEIR, the Project would be required to implement mitigation measure 4.9.3, which requires that prior to issuance of a building permit, that the applicant shall provide evidence from IID that water service exists for the project for all needs on site. As described in Threshold b below, the Proposed Project would construct a water treatment facility on site, however the construction of this facility would not result in a significant impact. With implementation of mitigation measure 4.9.3, impacts would be less than significant.

**Wastewater Treatment**

The Proposed Project will result in an increase in wastewater generation however, as described further in Threshold c below, septic systems and leach fields would be utilized by each individual part of the Project on site. The septic systems would be developed in accordance with the State and County standards and would be designed to meet capacity.

**Stormwater**

The introduction of new impervious surfaces to the Project would affect the amount of water absorption through the soils. However, the Project would implement mitigation measures 4.2.1 and 4.2.2 which would ensure that the amount and quality of stormwater would remain as unchanged as possible. The entire Project site would drain into a stormwater retention basin



Potentially Significant Impact (PSI)	Less Than Significant With Mitigation Incorporated (LTSWMI)	Less Than Significant Impact (LTSI)	No Impact (NI)
--------------------------------------	---	-------------------------------------	----------------

located on the northern portion of the Project site that is approximately 20 acres. This basin connects and would drain into the IID Newside Drain Number 1-A after upgrading the site's historical connection to said IID drain. The retention basin will be designed to meet SWRCB requirements and will include an appropriate mosquito abatement per County guidelines if the retention basin does fully discharge in less than 72 hours.

The Project would be required to implement mitigation measure 4.9.4 which would require that an adequate stormwater retention system exists for the project or that required new facilities will be available prior to issuance of a certificate of occupancy for the building.

Additionally, compliance with Specific Plan Mitigation Measure 4.2.3, Construction Stormwater Pollution Prevention Plan, as described in Section X Hydrology and Water Quality, would require that a Stormwater Pollution Prevention Plan be implemented during construction.

**Electric Power**

Electrical services will be provided from an existing distribution level voltage facility from IID near the cemetery, UPPR, Harris Road and/or self-generated with solar panels. If solar panels are used, they would be installed on the roofs of buildings and would interconnect by way of a bi-directional meter that would also serve as the metering element for power purchased from IID. The solar panels would be used solely for Project operations. The solar panels could utilize a battery energy storage element that would require approval from the County Planning Department, prior to installation. The Proposed Project would utilize approximately 2,892,422 kWh. The Project would be required to implement mitigation measure 4.9.2, which would require that the Project provide evidence that electrical services can be adequately provided prior to issuance of a building permit, if services are required through IID.

**Natural Gas**

Natural gas will be serviced by SoCal Gas' existing pipeline that will be extended to the Project site.. The Proposed Project would require approximately 3,631,469 thousand British Thermal Units (kBtu) of natural gas to operate at full build-out. While natural gas wasn't specifically analyzed in the MEIR previously, general mitigation measure 4.9.1 would ensure that all public utilities would be evaluated for ability to be supplied prior to project construction.

**Telecommunication**

Cellular coverage would likely be provided by telecom and internet service would likely be provided by Spectrum. Both providers have coverage for the area and since the area was a planned development, have likely planned build out of the site into existing and future capacity.

The Proposed Project will utilize the same utility providers that are used by the existing facilities around the Project site. The mitigation measures discussed in the MEIR and discussed above (measures 4.9.1 to 4.9.6 and 4.7.6) would be implemented by the Proposed Project to ensure that the utility providers confirm and work with the Applicant to determine where the utilities shall be connected and that adequate services are available for the Project site. Implementation of the Project would be consistent with the MEIR and would not result in any new impacts not previously analyzed. Impacts would be less than significant with mitigation incorporated.

- b) Have sufficient water supplies available to serve the project from existing and reasonably foreseeable future development during normal, dry and multiple dry years?

**b) Less than Significant with the MEIR, Less than Significant with mitigations.** The Project will include a water treatment, storage and distribution system that will satisfy potable water and fire water requirements. The system will receive water from the IID Dahlia Lateral 8 canal located along the southerly boundary of the Project. The treatment, storage and pump elements of the system will be located on anthe approximately 2-acre lot in the Project. The distribution element of the system will be a looped pressurized water line located within the Project roadway that will provide access to water for all Project parcels. The water treatment, storage and distribution system will likely be developed in phases with an initial phase having a storage capacity of approximately 180,000 gallons and a built-out storage capacity of up to 1.5 million gallons. Conversely, during initial site operations and prior to the need for a public water system, the applicant may truck-in purified/potable. A 1.5 million gallon tank would be approximately 50 feet tall and approximately 100 feet in diameter.

Water for the restrooms, fire water and water for operations would be provided from the overall project's centralized water treatment and distribution system

**Table 16: Proposed Water Use**

Use	Acre-Feet Per Year (AFY)
Existing	
Agricultural Operations	630*

Potentially Significant Impact (PSI)      Less Than Significant With Mitigation Incorporated (LTSWMI)      Less Than Significant Impact (LTSI)      No Impact (NI)

Total	630
<b>Proposed</b>	
Existing Cemetery and Memorial Area	50
Grain Elevator System	20
Hay and Grain Export and Container Depot	30
Produce / Food Export	25
Fuel Blending / Transloading	15
Fueling Station Including CNG	10
General Commodities: Transloading/Warehouse	30
<b>Total</b>	180
Net Decrease	450

\* Based on a water use factor of 5.25 acre-feet per acre per year.

Similar to other Projects in the MEIR, the Project would be required to implement mitigation measure 4.9.3, which requires that prior to issuance of a building permit, that the applicant shall provide evidence from IID that water service exists for the project for all needs on site. As described in Threshold b below, the Proposed Project would construct a water treatment facility on site, however the construction of this facility would not result in a significant impact. With implementation of mitigation measure 4.9.3, impacts would be less than significant.

- c) Result in a determination by the wastewater treatment provider which serves or may serve the project that it has adequate capacity to serve the project's projected demand in addition to the provider's existing commitments?

**c) Consistent with the MEIR, Less than Significant with Mitigation.** As previously mentioned, according to the MEIR, there is no wastewater treatment available within the specific plan area. The nearest treatment plant is located in the City of Imperial which would require a pump station and force main, and an agreement from the City to provide service to the Proposed Project.

The Project will include septic systems with leach fields for the different elements of the logistics center, which would result in up to nine separate septic systems. The septic systems and leach fields would be required to be constructed with State and County standards.

Additionally, the Project would be required to implement Mitigation Measure 4.9.5 which would require that prior to issuance of any building permit for any new building, the building permit applicant shall provide evidence of an adequate system for wastewater disposal. With implementation of the aforementioned mitigation, impacts would remain less than significant.

- d) Generate solid waste in excess of State or local standards, or in excess of the capacity of local infrastructure, or otherwise impair the attainment of solid waste reduction goals?
- e) Comply with federal, state, and local management and reduction statutes and regulations related to solid waste?

**d and e) Consistent with the MEIR, Less than Significant with Mitigation.** Solid wastes would be generated during construction and operation of the Proposed Project. These wastes would include discarded materials and packaging such as scrap metal, concrete, rubble, plaster, wood, paper material and potentially hazardous materials (which are discussed in the Hazards and Hazardous Materials section).

All municipal waste would be sent to Allied Imperial Landfill which is owned and operated by Republic Services, Inc. and is located approximately 4 miles southeast of the Project site (Google 2023). While there is not significant information available for the landfill, in 2011 the permitted area of the landfill increased from 170 acres to 337 acres and waste tonnage limits increase from 1,135 to 1,700 tons per day and estimated closure date changed from 2012 to 2040 (CalRecycle 2011).

All special waste would be sent to the Desert Valley Company Monofill and all hazardous waste would be sent to the Clean Harbors Facility. Desert Valley Company Monofill is expected to reach capacity by 2025. However, they have proposed to expand the facility by adding new waste storage cells and associated facilities. Daily volumes of waste are not expected to change (at 750 tons per day). Expansion would increase the capacity by 2.6 million cubic yards thereby extending its operations to 2080 (County 2021). The Clean Harbors facility is one of three Class I hazardous wastes treatment, storage and disposal facility in California. It has a design capacity of 5 million cubic yards and receives an annual capacity of 440,000 cubic yards (Clean Harbors 2023).

Potentially Significant Impact (PSI)	Less Than Significant With Mitigation Incorporated (LTSWMI)	Less Than Significant Impact (LTSI)	No Impact (NI)
--------------------------------------	---	-------------------------------------	----------------

According to CalRecycle's estimated solid waste generation rates, industrial sectors can generate a range of 8.93 pounds to 41.64 pounds of waste per employee per day (CalRecycle 2023a). With an estimate of 56 employees, this would equate to approximately 2,331 pounds per day or 1.2 tons per day (41.64 pounds per employee). Analyzing a worst case scenario, this amount would represent a minimal increase in the daily throughput at each facility which would represent approximately 438 tons per year.

Per CalGreen Construction Waste Management requirements, projects are required to recycle and/or salvage for reuse a minimum of 65% of the nonhazardous construction and demolition wastes or meet local construction and demolition waste, whichever is more stringent (CalRecycle 2023b). The Proposed Project is also required to comply with SB 1383 that establishes emission reduction goals by reducing the amount of organic material disposed in landfills. The Project would directly help with meeting SB 1383 with construction and operation of the proposed Project.

As described in the MEIR (Mitigation Measures 4.7.6 and 4.9.6), prior to final approval of the final maps for development within the specific plan area, a waste management plan shall be implemented to comply with the County's Integrated Waste Management Plan to be approved by Planning and Development Services. This should include types and quantity of waste materials that are expected to enter the waste stream. This would ensure that an adequate plan is in place, and that the Project is consistent with the County's requirements. Therefore, implementation of the Project would be consistent with the MEIR and would not result in any new impacts not previously analyzed. Impacts would be less than significant with mitigation incorporated.

**XX WILDFIRE**

If located in or near state responsibility areas or lands classified as very high fire hazard severity zones, would the Project:

- |  |                          |                                     |                                     |                          |
|--|--------------------------|-------------------------------------|-------------------------------------|--------------------------|
| a) Substantially impair an adopted emergency response plan or emergency evacuation plan?   | <input type="checkbox"/> | <input type="checkbox"/>            | <input checked="" type="checkbox"/> | <input type="checkbox"/> |
| b) Due to slope, prevailing winds, and other factors, exacerbate wildfire risks, and thereby expose project occupants to pollutant concentrations from a wildfire or the uncontrolled spread of a wildfire?  | <input type="checkbox"/> | <input type="checkbox"/>            | <input checked="" type="checkbox"/> | <input type="checkbox"/> |
| c) Require the installation or maintenance of associated infrastructure (such as roads, fuel breaks, emergency water sources, power lines or other utilities) that may exacerbate fire risk or that may result in temporary or ongoing impacts to the environment? | <input type="checkbox"/> | <input checked="" type="checkbox"/> | <input type="checkbox"/>            | <input type="checkbox"/> |
| d) Expose people or structures to significant risks, including downslope or downstream flooding or landslides, as a result of runoff, post-fire slope instability, or drainage changes?  | <input type="checkbox"/> | <input type="checkbox"/>            | <input checked="" type="checkbox"/> | <input type="checkbox"/> |

**Summary of Impacts Identified in the MEIR:**

In 2018, the Office of Planning and Research updated the CEQA Guidelines to include Wildfire as a resource area to the Appendix G checklist. The section aimed to answer wildfire related questions indicating whether a project was located in or near a state responsibility area or on lands that are classified as very high fire hazard severity zones. During the preparation of the MEIR, wildfire impacts were not part of the analysis, as it was not a resource area required for discussion. Any fire-related discussions were limited to hazardous materials, public services, fire suppression, and emergency services with the County Fire Department.

**Impacts Related to the Proposed Project:**

- |  |                          |                                     |                                     |                          |
|--|--------------------------|-------------------------------------|-------------------------------------|--------------------------|
| a) Substantially impair an adopted emergency response plan or emergency evacuation plan?   | <input type="checkbox"/> | <input type="checkbox"/>            | <input checked="" type="checkbox"/> | <input type="checkbox"/> |
| b) Due to slope, prevailing winds, and other factors, exacerbate wildfire risks, and thereby expose project occupants to pollutant concentrations from a wildfire or the uncontrolled spread of a wildfire?  | <input type="checkbox"/> | <input type="checkbox"/>            | <input checked="" type="checkbox"/> | <input type="checkbox"/> |
| c) Require the installation or maintenance of associated infrastructure (such as roads, fuel breaks, emergency water sources, power lines or other utilities) that may exacerbate fire risk or that may result in temporary or ongoing impacts to the environment? | <input type="checkbox"/> | <input checked="" type="checkbox"/> | <input type="checkbox"/>            | <input type="checkbox"/> |

	Potentially Significant Impact (PSI)	Less Than Significant With Mitigation Incorporated (LTSWMI)	Less Than Significant Impact (LTSI)	No Impact (NI)
--	--------------------------------------	---	-------------------------------------	----------------

- d) Expose people or structures to significant risks, including downslope or downstream flooding or landslides, as a result of runoff, post-fire slope instability, or drainage changes?

**a), b) and d) Less than Significant Impact.** The California Department of Forestry and Fire Protection's Fire and Resource Assessment Program (FRAP) provides a Fire Hazards Severity Zone Viewer (FHSZ) to provide a visual reference to locate fire hazards areas in California. The maps were developed utilizing science and field-tested models that assign a hazard score based on factors that influence fire likelihood and behavior. Factors include but are not limited to fire history, existing and potential fuel (natural vegetation), predicted flame length, embers, terrain, and typical fire weather in the area.

The Project site is not located within a FHSZ area. Most of the moderate to very high fire hazard areas are located to the north adjacent to the Salton Sea near Salton City, Anza-Borrego Desert State Park, and the Cleveland National Forest. There are no areas within the immediate vicinity of the Project site that are designated as areas that have potential for wildland fires. Additionally, the Project site and surrounding area is generally flat and would not result in downstream flooding, landslides or exacerbate wildfire risks or result in result in post-fire slope instability.

As previously discussed in the Hazards and Hazardous Materials Section, temporary or single-lane closure of some roadways may occur during the transport of oversized equipment or construction activities. Road closures would be coordinated with County Public Works, the County Sheriff, and ICFD prior to closure, and would be scheduled to occur during off-peak commute hours. The Project's construction and operational activities would be in compliance with the Imperial County Emergency Operations Plan (EOP) and Multi-Jurisdiction Hazard Mitigation Plan (MJHMP) and would not physically interfere with the execution of the policies and procedures in these plans (County 2015b; 2016b). Therefore, the Project would not impair implementation of or physically interfere with an adopted emergency response plan or emergency evacuation plan.

The Project proposes construction and operation of an industrial park, logistics center for food and commodity imports and exports, and rail loop tracks to connect to the existing UPPR, a fueling station. These uses are permitted with the submittal and approval of Project applications. The Proposed Project does not propose any changes to the EOC or the EOP nor does the construction occur near the primary and alternate EOCs that could cause a physical impairment to the facilities. Therefore, impacts would be less than significant.

- c) Require the installation or maintenance of associated infrastructure (such as roads, fuel breaks, emergency water sources, power lines or other utilities) that may exacerbate fire risk or that may result in temporary or ongoing impacts to the environment?

**c) Less than Significant Impact with Mitigation.** The Proposed Project is not located with a FHSZ, however, as previously mentioned, a centralized water treatment, storage and distribution system would be installed to provide firewater to the Project area. Water for fire protection would be purchased from IID and stored in an above ground storage tank in accordance with County Fire Department standards. The system will be designed in accordance with federal, state, and local fire codes, occupational health and safety regulations and other jurisdictional codes, requirements, and standard practices. The Project site would also include hydrants for fire suppression. Additionally, as mentioned in Section V Public Services, the Project would implement mitigation measure 4.7.7 and 4.7.8, which will require the County Fire Chief evaluate the Project development to ensure adequate operation of fire emergency services and supply of water. Additionally, mitigation measure 4.7.9, requires that the prior to occupancy the fire suppression system be installed and operational.

Furthermore, the Imperial County Fire Department maintains mutual aid agreements with Brawley Fire Department and Imperial County Fire Department and completion of the Proposed Project would include payment of development fees that would support the fire department and other County services. With implementation of the above mitigation, and the project design features, impacts would be less than significant.

*Note: Authority cited: Sections 21083 and 21083.05, Public Resources Code. Reference: Section 65088.4, Gov. Code; Sections 21080(c), 21080.1, 21080.3, 21083, 21083.05, 21083.3, 21093, 21094, 21095, and 21151, Public Resources Code; Sundstrom v. County of Mendocino, (1988) 202 Cal.App.3d 296; Leonoff v. Monterey Board of Supervisors, (1990) 222 Cal.App.3d 1337; Eureka Citizens for Responsible Govt. v. City of Eureka (2007) 147 Cal.App.4th 357; Protect the Historic Amador Waterways v. Amador Water Agency (2004) 116 Cal.App.4th at 1109; San Franciscans Upholding the Downtown Plan v. City and County of San Francisco (2002) 102 Cal.App.4th 656.*

Revised 2009- CEQA  
 Revised 2011- ICPDS  
 Revised 2016 – ICPDS  
 Revised 2017 – ICPDS  
 Revised 2019 – ICPDS



Potentially Significant Impact (PSI)	Less Than Significant with Mitigation Incorporated (LTSWMI)	Less Than Significant Impact (LTSI)	No Impact (NI)
--------------------------------------	---	-------------------------------------	----------------

**SECTION 3**  
**III. MANDATORY FINDINGS OF SIGNIFICANCE**

The following are Mandatory Findings of Significance in accordance with Section 15065 of the CEQA Guidelines.

- a) Does the project have the potential to substantially degrade the quality of the environment, substantially reduce the habitat of a fish or wildlife species, cause a fish or wildlife population to drop below self-sustaining levels, threaten to eliminate a plant or animal community, substantially reduce the number or restrict the range of a rare or endangered plant or animal, eliminate tribal cultural resources or eliminate important examples of the major periods of California history or prehistory?

a) **Less than Significant Impact with Mitigation.** Based on the discussions in Section IV Biological Resources, a biological resources survey was complete for the Project site, and with implementation of mitigation, impacts would be less than significant, and the proposed Project would not have the potential to substantially reduce the habitat of fish and wildlife species, cause a fish or wildlife population to drop below self-sustaining levels, eliminate a plant or animal community, or reduce the number or restrict the range of a rare or endangered plant or animal.

Lastly, as discussed in Section V, Cultural Resources, a cultural resources survey was complete for the Project, and the Project would not have the potential to substantially adversely affect previously unidentified archaeological resources or eliminate important examples of the major periods of California history or prehistory. For the reasons outlined above, the Project would not substantially degrade the quality of the environment, substantially reduce the habitat of a fish or wildlife species, cause a fish or wildlife population to drop below self-sustaining levels, threaten to eliminate a plant or animal community, substantially reduce the number or restrict the range of a rare or endangered plant or animal or eliminate important examples of the major periods of California history or prehistory, and therefore the Project would have less than significant impacts.

- b) Does the project have impacts that are individually limited, but cumulatively considerable? ("Cumulatively considerable" means that the incremental effects of a project are considerable when viewed in connection with the effects of past projects, the effects of other current projects, and the effects of probable future projects.)

b) **Less than Significant Impact with Mitigation.** The Project does not have potential impacts that are individually limited, but cumulatively considerable. Based on the analysis contained in the above Sections, the proposed Project would not result in any significant and unmitigable impacts in any environmental categories. In all cases, effects associated with the Project would be limited to the existing Project Area/disturbance footprint and either result in no new impacts, less than significant impacts, or less than significant impacts with mitigation incorporated. As such, Project impacts are of such a negligible degree that they would not result in a significant contribution to any cumulative impacts. This is largely due to the fact that the impacts from the Specific Plan buildout were already evaluated in the MEIR, and the Project activities would not significantly stray from what was previously analyzed in the Mesquite Lake Specific Plan.

Cumulative impacts could occur if the construction of other projects occurs at the same time as the Proposed Project and in the same geographic scope, such that the effects of similar impacts of multiple projects combine to create greater levels of impact than would occur at the Project-level. The nearest cumulative Project which may contribute to cumulative impacts, is the True North Organics Renewable Energy project, which is located just under 2.5 miles east of the Project site. However, this Project is also located within the Mesquite Lake Specific Plan area, which the area was evaluated as a whole, in the MEIR.

Potentially Significant Impact (PSI)	Less Than Significant With Mitigation Incorporated (LTSWMI)	Less Than Significant Impact (LTSI)	No Impact (NI)
---	---	--	-------------------

---

Similar to the Proposed Project, the True North Organics Renewable Energy project is also requesting a Specific Plan Amendment. Therefore, similar to the Proposed Project, the True North Organics Renewable Energy project isn't analyzed fully in the MEIR, but the Specific Plan Amendment will not create impacts that could be cumulatively considerable. Additionally, the approval of either Project would not result in future approvals of any Specific Plan Amendments, or make any Specific Plan Amendments easier to obtain.

All Project impacts were considered to be less than significant with mitigation implemented. Additionally, given that the Project operations would not occur in close proximity to any residences or neighborhood communities, and the fact that Project activities would be short-term, the Project's impacts would not combine with the impacts of other projects to create cumulative construction- and/or operation-related impacts in resource areas such as air quality, noise, and transportation.

- c) **Does the project have environmental effects, which will cause substantial adverse effects on human beings, either directly or indirectly?**

c) **Less than Significant Impact with Mitigation.** Effects to human beings are generally associated with air quality, noise, traffic safety, geology/soils, and hazards/hazardous materials. As discussed in the previous environmental topic areas, the Project would not result in significant impacts to human beings because the Proposed Project would not cause significant impacts to air quality, noise, hazards, and traffic that would impact humans in the area. Implementation of mitigation measures for air quality and hazards/hazardous materials would reduce impacts to less than significant. The impacts to human beings as a result of the Project, would be less than significant with the mitigation incorporated.

#### **IV. PERSONS AND ORGANIZATIONS CONSULTED**

This section identifies those persons who prepared or contributed to preparation of this document. This section is prepared in accordance with Section 15129 of the CEQA Guidelines.

##### **A. COUNTY OF IMPERIAL**

- Jim Minnick, Director of Planning & Development Services
- David Black, Project Planner

##### **B. CHAMBERS GROUP**

- Thomas Strand, Project Manager
- Eunice Bagwan, Environmental Planner
- Paul Morrissey, Director of Biology
- Lucas Tutschulte, Director of Cultural Resources
- Phillip Carlos, GIS Specialist

##### **C. OTHER AGENCIES/ORGANIZATIONS**

###### **GTS**

- Rawad Hani, P.E., T.E., Managing Principal

###### **Ldn Consulting, Inc**

- Jeremy Loudon, Principal

###### **Linscott, Law & Greenspan, Engineers**

- John A. Boaman, P.E., Principal

###### **POWER Engineers Inc.**

- Charlie Koenig, Project Manager
- Matthew Acker, Visualization Specialist

###### **Quechan Tribe of the Fort Yuma Reservation**

- Jill McCormick, M.A., Historic Preservation Officer



## V. REFERENCES

### California Department of Conservation (DOC)

- 2022a California Important Farmland Finder. Accessed August 1, 2022. Available online at: <https://maps.conservation.ca.gov/DLRP/CIFF/>
- 2022b Williamson Act Status Report 2020-21. Accessed August 1, 2022 at: [https://www.conservation.ca.gov/dlrp/wa/Documents/stats\\_reports/2022%20WA%20Status%20Report.pdf](https://www.conservation.ca.gov/dlrp/wa/Documents/stats_reports/2022%20WA%20Status%20Report.pdf)
- 2022c California Geological Survey, Data Viewer. Accessed October 22, 2022. Available online at: <https://maps.conservation.ca.gov/cgs/DataViewer/index.html>.
- 2022d Mineral Land Classification. Accessed August 1, 2022 at: <https://maps.conservation.ca.gov/cgs/informationwarehouse/index.html?map=mlc>

### California Department of Forestry and Fire Protection (CALFIRE)

- 2023 Fire Hazard Severity Zone Viewer. Accessed January 2023. Available online at: <https://egis.fire.ca.gov/FHSZ/>

### California Department of Transportation (Caltrans)

- 2018 California State Scenic Highway System Map. Updated in 2018. Available online at: <https://caltrans.maps.arcgis.com/apps/webappviewer/index.html?id=465dfd3d807c46cc8e8057116f1aaca>.

### California Employment Development Department (EDD)

- 2022 El Centro Metropolitan Statistical Area (MSA) Press Release. Published on October 21, 2022. Available online at: [https://www.labormarketinfo.edd.ca.gov/file/1fmonth/ecen\\$pds.pdf](https://www.labormarketinfo.edd.ca.gov/file/1fmonth/ecen$pds.pdf).

### California Recycle (CalRecycle)

- 2011 Public Notice: Imperial Landfill – Imperial County. Revised Solid Waste Facilities Permit. Available online at: <https://www2.calrecycle.ca.gov/PublicNotices/Details/499>.
- 2023a Estimated Solid Waste Generation Rates. Industrial Sector Generation Rates. Available online at: <https://www2.calrecycle.ca.gov/wastecharacterization/general/rates>.
- 2023b Estimated Solid Waste Generation Rates. Available online at: <https://www2.calrecycle.ca.gov/wastecharacterization/general/rates#Institution>.

### Clean Harbors

- 2023 Westmorland Landfill Facility. Available online at: <https://www.cleanharbors.com/location/westmorland-landfill-facility>.

### Department of Toxic Substances Control (DTSC)

- 2023 EnviroStor. Accessed January 5, 2023. Available online at: <https://dtsc.ca.gov/your-envirostor/>.

### Federal Emergency Management Agency (FEMA)

- 2008 Flood Map Service Center, Map 06025C1375C, effective 09/26/2008. Available online at: <https://msc.fema.gov/portal/search?AddressQuery=imperial%2C%20ca#searchresultsanchor>.

### Google Earth Pro (Google)

- 2023 Google Earth Pro Desktop Viewer. Imagery date 3/20/2015; Accessed January 5, 2023. Available for download here: <https://www.google.com/earth/versions/>.

### Imperial County (County)

- 1993a Imperial County General Plan Final EIR. Available online at: <https://www.icpds.com/planning/land-use-documents/general-plan/general-plan-eir>.

- 1993b Imperial County General Plan. Available online at: <https://www.icpds.com/planning/land-use-documents/general-plan>.
- 2006 Mesquite Lake Specific Plan. Available online at: <https://www.icpds.com/assets/planning/specific-plans/mesquite-lake/mesquite-lake-sp.pdf>.
- 2015a Imperial County General Plan Noise Element. October 6, 2015. Available online at: <https://www.icpds.com/assets/planning/noise-element-2015.pdf>.
- 2015b Imperial County Multi-Jurisdiction Hazard Mitigation Plan Update. Available online at: <https://firedept.imperialcounty.org/wp-content/uploads/2019/10/ICMHMP.pdf>
- 2016a Imperial County General Plan Conservation and Open Space Element. March 8, 2016. Available online at: <https://www.icpds.com/assets/planning/conservation-open-space-element-2016.pdf>.
- 2016b Imperial County Emergency Operations Plan. Available online at: <https://firedept.imperialcounty.org/wp-content/uploads/2019/10/EmergencyOpPlan.pdf>
- 2021 Desert Valley Company Monofill Expansion Project, Cell 4. Available online at: <https://www.icpds.com/assets/GPA18-0004-ZC18-0005-CUP18-0025-DVC-Draft-EIR-.pdf>.

State Water Resources Control Board (SWRCB)

- 2023 GeoTracker. Accessed January 5, 2023. Available online at: <https://geotracker.waterboards.ca.gov/>.

10/10/10

10/10/10

10/10/10

10/10/10

10/10/10

10/10/10

10/10/10

10/10/10

10/10/10

10/10/10

10/10/10

10/10/10

10/10/10

10/10/10

10/10/10

10/10/10

10/10/10

10/10/10

10/10/10

10/10/10

10/10/10

10/10/10

10/10/10

10/10/10

10/10/10

EEC ORIGINAL PKG

**ADMINISTRATION / TRAINING**

1078 Dogwood Road  
Heber, CA 92249

**Administration**

Phone: (442) 265-6000  
Fax: (760) 482-2427

**Training**

Phone: (442) 265-6011

**OPERATIONS/PREVENTION**

2514 La Brucherie Road  
Imperial, CA 92251

**Operations**

Phone: (442) 265-3000  
Fax: (760) 355-1482

**Prevention**

Phone: (442) 265-3020

February 14, 2022

RE: Specific Plan SP21-000, Zone Change ZC21-0005, and Tentative Tract Map TR00993  
Tomcat Grain Elevator and Rail System

APN: 040-340-004, 006, 032, & 033

Imperial County Fire Department would like to thank you for the opportunity to review and comment on the Tomcat Grain Elevator and Rail System Specific Plan, Zone Change, and Tentative Tract Map.

Imperial County Fire Department has the following comments and/or requirements.

- An approved water supply capable of supplying the required fire flow determined by appendix B in the California Fire Code shall be installed and maintained. Private fire service mains and appurtenance shall be installed in accordance with NFPA 24. \*Please see exception below regarding pressurized water system. Fire Suppression water requirement will be agreed upon once Fire Department meets with applicant.
- Fire department access roads and gates will be in accordance with the current adopted fire code and the facility will maintain a Knox Box/lock for access on site.
- Compliance with all required sections of the California Fire Code.
- Fiscal Impacts will remain open until meeting with department head(s) and developer(s), which may include but not limited to:
  - Capital purchases which may be required to assist in servicing this project
  - Costs for services during construction and life of the project
  - Training

The zone change will require an approved pressurized water supply capable of meeting required fire flows to be installed and maintained in accordance with the California Fire Code. ML- I-3 Mesquite Lake specific plan with heavy industrial will require greater water demand due to the potential hazards and fire loads associated with industrial operations. This requirement will be initiated by ICFD official upon complete review of the project and project description and will make that determination before grading permit approval.

The proposed railroad spur will be required have unobstructed access to the inner yard at all time if being used for any industrial activities. Access roads shall meet all requirements from the

AN EQUAL OPPORTUNITY/AFFIRMATIVE ACTION EMPLOYER

**EEC ORIGINAL PKG**



**ADMINISTRATION / TRAINING**

1078 Dogwood Road  
Heber, CA 92249

**Administration**

Phone: (442) 265-6000  
Fax: (760) 482-2427

**Training**

Phone: (442) 265-6011



**OPERATIONS/PREVENTION**

2514 La Brucherie Road  
Imperial, CA 92251

**Operations**

Phone: (442) 265-3000  
Fax: (760) 355-1482

**Prevention**

Phone: (442) 265-3020

California Fire Code for fire apparatus roadways. Imperial County Fire Department is requiring two (2) points of entry based on potential impairments. Bridges will be constructed in accordance with the California Fire Code and shall be able to carry imposed loads of fire apparatus.

Imperial County Fire Department reserves the right to comment and request additional requirements pertaining to this project regarding fire and life safety measures, California Building and Fire Code, and National Fire Protection Association standards at a later time as we see necessary.

If you have any questions, please contact the Imperial County Fire Prevention Bureau at 442-265-3020 or 442-265-3021.

Sincerely  
Andrew Loper  
Lieutenant/Fire Prevention Specialist  
Imperial County Fire Department  
Fire Prevention Bureau

A handwritten signature in black ink, appearing to be "Andrew Loper".

CC  
Robert Malek  
Deputy Chief/Deputy Fire Marshal  
Imperial County Fire Department

Alfredo Estrada Jr.  
Fire Chief  
Imperial County Fire Department

AN EQUAL OPPORTUNITY/AFFIRMATIVE ACTION EMPLOYER

**EEC ORIGINAL PKG**

**California Department of Transportation**

DISTRICT 11  
4050 TAYLOR STREET, MS-240  
SAN DIEGO, CA 92110  
(619) 709-5152 | FAX (619) 688-4299 TTY 711  
[www.dot.ca.gov](http://www.dot.ca.gov)



June 15, 2023

11-IMP-86

PM 13.9

Tomcat Grain Elevator and Rail System  
Response To Comments, Conceptual Access Exhibit

Mr. Derek Dessert  
Vice President of Development  
Bona Terra  
26895 Aliso Creek Rd, Suite B-963  
Aliso Viejo, CA 92656

Dear Mr. Dessert:

Thank you for including the California Department of Transportation (Caltrans) in the review process for the Response To Comments (RTC) from May 25, 2023, and the Conceptual Access Exhibit (dated 05-25-2023) for the Tomcat Grain Elevator and Rail System Project located near State Route 86 (SR-86). The mission of Caltrans is to provide a safe and reliable transportation network that serves all people and respects the environment. The Local Development Review (LDR) Program reviews land use projects and plans to ensure consistency with our mission and state planning priorities.

Safety is one of Caltrans' strategic goals. Caltrans strives to make the year 2050 the first year without a single death or serious injury on California's roads. We are striving for more equitable outcomes for the transportation network's diverse users. To achieve these ambitious goals, we will pursue meaningful collaboration with our partners. We encourage the implementation of new technologies, innovations, and best practices that will enhance the safety on the transportation network. These pursuits are both ambitious and urgent, and their accomplishment involves a focused departure from the status quo as we continue to institutionalize safety in all our work.

Caltrans has the following comments:

**Traffic Engineering and Analysis**

SR-86 is within the project location and is currently access controlled with only the existing intersection (near the cemetery) designated as open for access. Consult with

"Provide a safe and reliable transportation network that serves all people and respects the environment"

**EEC ORIGINAL PKG**

Mr. Dessert  
June 15, 2023  
Page 2

the Right-of-Way (R/W) Division, the R/W Engineering Branch, and the Design Branch for new opening access requests (to determine if access is allowed) within this access-controlled area.

Please provide documentation as to why the secondary emergency access is not available from the local road (County of Imperial).

Please also provide documentation as to why the widening of the current access cannot occur.

**Right-of-Way**

This area currently is access controlled with only a designated area being open for access. Those areas are outlined in the maps that were attached in Caltrans' February 15, 2022, comment letter. Further coordination with Caltrans would be needed to determine if Decertification could occur for purchasing new access rights or possibly swap the current access being quitclaimed to gain new access of the same type. Review of change of access rights does not guarantee approval. There is access control currently in the areas the applicant is requesting to have access.

If you have any questions or concerns, please contact Charlie Lecourtois, LDR Coordinator, at (619) 985-4766 or by e-mail sent to [Charlie.Lecourtois@dot.ca.gov](mailto:Charlie.Lecourtois@dot.ca.gov).

Sincerely,

*Kimberly Dodson for*

MAURICE A. EATON  
Branch Chief  
Local Development Review

c: Diana Robinson

**California Department of Transportation**

DISTRICT 11  
4050 TAYLOR STREET, MS-240  
SAN DIEGO, CA 92110  
(619) 709-5152 | FAX (619) 688-4299 TTY 711  
[www.dot.ca.gov](http://www.dot.ca.gov)



February 15, 2022

11-IMP-86

PM 13.6

Tomcat Grain Elevator and Rail System  
Specific Plan, Zone Change, Tentative Tract Map

Mr. David Black  
Planner IV  
Imperial County Planning & Development Services  
801 Main Street  
El Centro, CA 92243

Dear Mr. Black:

Thank you for including the California Department of Transportation (Caltrans) in the review process for the Zone Change (Z21-0005), Tentative Tract Map (TR00993), and the Specific Plan (SP21-0001) for the Tomcat Grain Elevator and Rail System Project located near State Route 86 (SR-86).

The mission of Caltrans is to provide a safe and reliable transportation network that serves all people and respects the environment. The Local Development Review (LDR) Program reviews land use projects and plans to ensure consistency with our mission and state planning priorities.

Safety is one of Caltrans' strategic goals. Caltrans strives to make the year 2050 the first year without a single death or serious injury on California's roads. We are striving for more equitable outcomes for the transportation network's diverse users. To achieve these ambitious goals, we will pursue meaningful collaboration with our partners. We encourage the implementation of new technologies, innovations, and best practices that will enhance the safety on the transportation network. These pursuits are both ambitious and urgent, and their accomplishment involves a focused departure from the status quo as we continue to institutionalize safety in all our work.

We look forward to working with the County of Imperial in areas where the County and Caltrans have joint jurisdiction to improve the transportation network and connections between various modes of travel, with the goal of improving the experience of those who use the transportation system.

"Provide a safe and reliable transportation network that serves all people and respects the environment"

**EEC ORIGINAL PKG**



Caltrans has the following comments:

### **Hydrology and Drainage Studies**

- Please provide off site hydrology and hydraulics studies, proposed drainage and proposed grading plans for Caltrans to review. Provide a pre-development and post-development hydrology and hydraulics study. Show drainage configurations and patterns.
  - Provide drainage plans and details. Provide existing and proposed drainage facilities.
  - Provide existing and proposed 2-foot contour grading with legible callouts.
  - Include detention basin details of inlets/outlet and proposed basin grading, include in detention basin calculations:
    - Plan schematic
    - Elevation vs storage tables
    - Elevation vs area tables
    - Elevation vs outlet flow (stage - outflow)
    - Inflow vs outflow
    - Elevation vs time (stage - time)
    - Volume vs time (storage - time)
- Provide a Drainage Study showing 100-year storm event calculations and 25- year storm event calculations.
- Provide on-site hydrology and hydraulic studies per the Highway Design Manual methodologies and per Caltrans policies and procedures.
  - Provide all available Caltrans drainage facility as-built and Right-of-Way (R/W) Maps.
  - Provide survey data of onsite system that the development will be draining to.
- On all plans, show Caltrans' R/W and SR-86 centerline as appropriate.
- Early coordination with Caltrans is recommended.
- Caltrans generally does not allow development projects to impact hydraulics within the State's R/W. Any modification to the existing Caltrans drainage and/or increase in runoff to State facilities will not be allowed.

### **Complete Streets and Mobility Network**

Caltrans views all transportation improvements as opportunities to improve safety, access and mobility for all travelers in California and recognizes bicycle, pedestrian and transit modes as integral elements of the transportation network. Caltrans supports improved transit accommodation through the provision of Park and Ride

facilities, improved bicycle and pedestrian access and safety improvements, signal prioritization for transit, bus on shoulders, ramp improvements, or other enhancements that promotes a complete and integrated transportation network. Early coordination with Caltrans, in locations that may affect both Caltrans and the County of Imperial, is encouraged.

To reduce greenhouse gas emissions and help achieve California's Climate Change targets, Caltrans is implementing Complete Streets and Climate Change policies into State Highway Operations and Protection Program (SHOPP) projects to meet multi-modal mobility needs. Caltrans looks forward to working with the County to evaluate potential Complete Streets projects.

Bicycle, pedestrian, and public transit access during construction is important. Mitigation to maintain bicycle, pedestrian, and public transit access during construction is in accordance with Caltrans' goals and policies.

### **Land Use and Smart Growth**

Caltrans recognizes there is a strong link between transportation and land use. Development can have a significant impact on traffic and congestion on State transportation facilities. In particular, the pattern of land use can affect both local vehicle miles traveled and the number of trips. Caltrans supports collaboration with local agencies to work towards a safe, functional, interconnected, multi-modal transportation network integrated through applicable "smart growth" type land use planning and policies.

The County should continue to coordinate with Caltrans to implement necessary improvements at intersections and interchanges where the agencies have joint jurisdiction.

### **Traffic Control Plan/Hauling**

Caltrans has discretionary authority with respect to highways under its jurisdiction and may, upon application and if good cause appears, issue a special permit to operate or move a vehicle or combination of vehicles or special mobile equipment of a size or weight of vehicle or load exceeding the maximum limitations specified in the California Vehicle Code. The Caltrans Transportation Permits Issuance Branch is responsible for the issuance of these special transportation permits for oversize/overweight vehicles on the State Highway network. Additional information is provided online at: <http://www.dot.ca.gov/trafficops/permits/index.html>

A Traffic Control Plan is to be submitted to Caltrans District 11, including the intersections at SR-86 and Grimes Road/Dahlia Later Eight, at least 30 days prior to the start of any construction. Traffic shall not be unreasonably delayed. The plan shall also outline suggested detours to use during closures, including routes and signage.

Potential impacts to the highway facilities (SR-86) and traveling public from the detour, demolition and other construction activities should be discussed and addressed before work begins.

### **Noise**

The applicant must be informed that in accordance with 23 Code of Federal Regulations (CFR) 772, Caltrans is not responsible for existing or future traffic noise impacts associated with the existing configuration of SR-86.

### **Environmental**

Caltrans welcomes the opportunity to be a Responsible Agency under the California Environmental Quality Act (CEQA), as we have some discretionary authority of a portion of the project that is in Caltrans' R/W through the form of an encroachment permit process. We look forward to the coordination of our efforts to ensure that Caltrans can adopt the alternative and/or mitigation measure for our R/W. We would appreciate meeting with you to discuss the elements of the EIR that Caltrans will use for our subsequent environmental compliance.

An encroachment permit will be required for any work within the Caltrans' R/W prior to construction. As part of the encroachment permit process, the applicant must provide approved final environmental documents for this project, corresponding technical studies, and necessary regulatory and resource agency permits. Specifically, CEQA determination or exemption. The supporting documents must address all environmental impacts within the Caltrans' R/W and address any impacts from avoidance and/or mitigation measures.

We recommend that this project specifically identifies and assesses potential impacts caused by the project or impacts from mitigation efforts that occur within Caltrans' R/W that includes impacts to the natural environment, infrastructure including but not limited to highways, roadways, structures, intelligent transportation systems elements, on-ramps and off-ramps, and appurtenant features including but not limited to lighting, signage, drainage, guardrail, slopes and landscaping. Caltrans is interested in any additional mitigation measures identified for the project's draft Environmental Document.

## **Broadband**

Caltrans recognizes that teleworking and remote learning lessen the impacts of traffic on our roadways and surrounding communities. This reduces the amount of VMT and decreases the amount of greenhouse gas (GHG) emissions and other pollutants. The availability of affordable and reliable, high speed broadband is a key component in supporting travel demand management and reaching the state's transportation and climate action goals.

## **Mitigation**

Caltrans endeavors that any direct and cumulative impacts to the State Highway network be eliminated or reduced to a level of insignificance pursuant to the California Environmental Quality Act (CEQA) and National Environmental Policy Act (NEPA) standards.

Mitigation measures to State facilities should be included in TIS/TIA. Mitigation identified in the traffic study, subsequent environmental documents, and mitigation monitoring reports, should be coordinated with Caltrans to identify and implement the appropriate mitigation. This includes the actual implementation and collection of any "fair share" monies, as well as the appropriate timing of the mitigation. Mitigation improvements should be compatible with Caltrans concepts.

## **Right-of-Way**

- Clearly show access permissions on tentative map along Highway 86.
- Ensure clear sight distance if entering and exiting the highway in these locations.
- Show any found monuments and survey markers along Highway 86.
- Perpetuate any survey monuments that will be destroyed by construction per LS act 8771
- Ensure that any proposed drainage does not impact Caltrans highway and if so, it will need to comply with Caltrans Policy.
- Any access onto Caltrans property that is not in the permitted access points along SR-86 will need to go through the encroachment permit process.
- Clearly show parcels as described on sheet 1 out of 2 of TR00993, there is no clear delineation between old parcels and new lots.
- Show all easements even abandoned easements and verify they are no longer needed.
- There appears to be another Parcel in the top right corner that is not accounted for in the Tentative Map APN 040-340-019-000. Is this a part of this subdivision?
- Consult Subdivision Map Act for guidance.



- Per Business and Profession Code 8771, perpetuation of survey monuments by a licensed land surveyor is required, if they are being destroyed by any construction.
- Any work performed within Caltrans' R/W will require discretionary review and approval by Caltrans and an encroachment permit will be required for any work within the Caltrans' R/W prior to construction.

Additional information regarding encroachment permits may be obtained by contacting the Caltrans Permits Office at (619) 688-6158 or emailing [D11.Permits@dot.ca.gov](mailto:D11.Permits@dot.ca.gov) or by visiting the website at <https://dot.ca.gov/programs/traffic-operations/ep>. Early coordination with Caltrans is strongly advised for all encroachment permits.

### **Right-of-Way Utilities**

Tomcat Development LLC shall prepare and submit to Caltrans closure plans as part of the encroachment permit application. The plans shall require that closure or partial closure of SR-86 be limited to times as to create the least possible inconvenience to the traveling public and that signage be posted prior to the closure to alert drivers of the closure in accordance with Caltrans requirements. Traffic shall not be unreasonably delayed. The plan shall also outline suggested detours to use during the closures, traffic, including routes and signage.

As part of the encroachment permit process, the applicant must provide an approved final environmental document including the California Environmental Quality Act (CEQA) determination addressing any environmental impacts with the Caltrans' R/W, and any corresponding technical studies.

This project should require a meeting with Union Pacific Rail Road (UPRR) and California Public Utilities Commission (CPUC).

Please see the following chapters in the Caltrans' manuals:

- Chapter 600 of the Encroachment Permits Manual for requirements regarding utilities and state R/W: <https://dot.ca.gov/-/media/dot-media/programs/traffic-operations/documents/encroachment-permits/chapter-6-ada-a11y.pdf> .
- Chapter 2-2.13 of the Plans Preparation Manual for requirements regarding utilities and state R/W: <https://dot.ca.gov/-/media/dot-media/programs/design/documents/cadd/ppm-text-ch2-sect2-13-a11y.pdf>
- Chapter 17 of the Project Development Procedures Manual <https://dot.ca.gov/-/media/dot-media/programs/design/documents/pdpm-chapter17-a11y.pdf>.

Mr. David Black, Planner IV  
February 15, 2022  
Page 7

If you have any questions or concerns, please contact Charlie Lecourtois, LDR  
Coordinator, at (619) 985-4766 or by e-mail sent to [Charlie.Lecourtois@dot.ca.gov](mailto:Charlie.Lecourtois@dot.ca.gov).

Sincerely,

*Maurice A. Eaton*

MAURICE EATON  
Branch Chief  
Local Development Review

Attachment

Right of Way Map I0861301.tif, and I0861302.tif

T. 14 S., R. 14 E., S. B. B. & M.

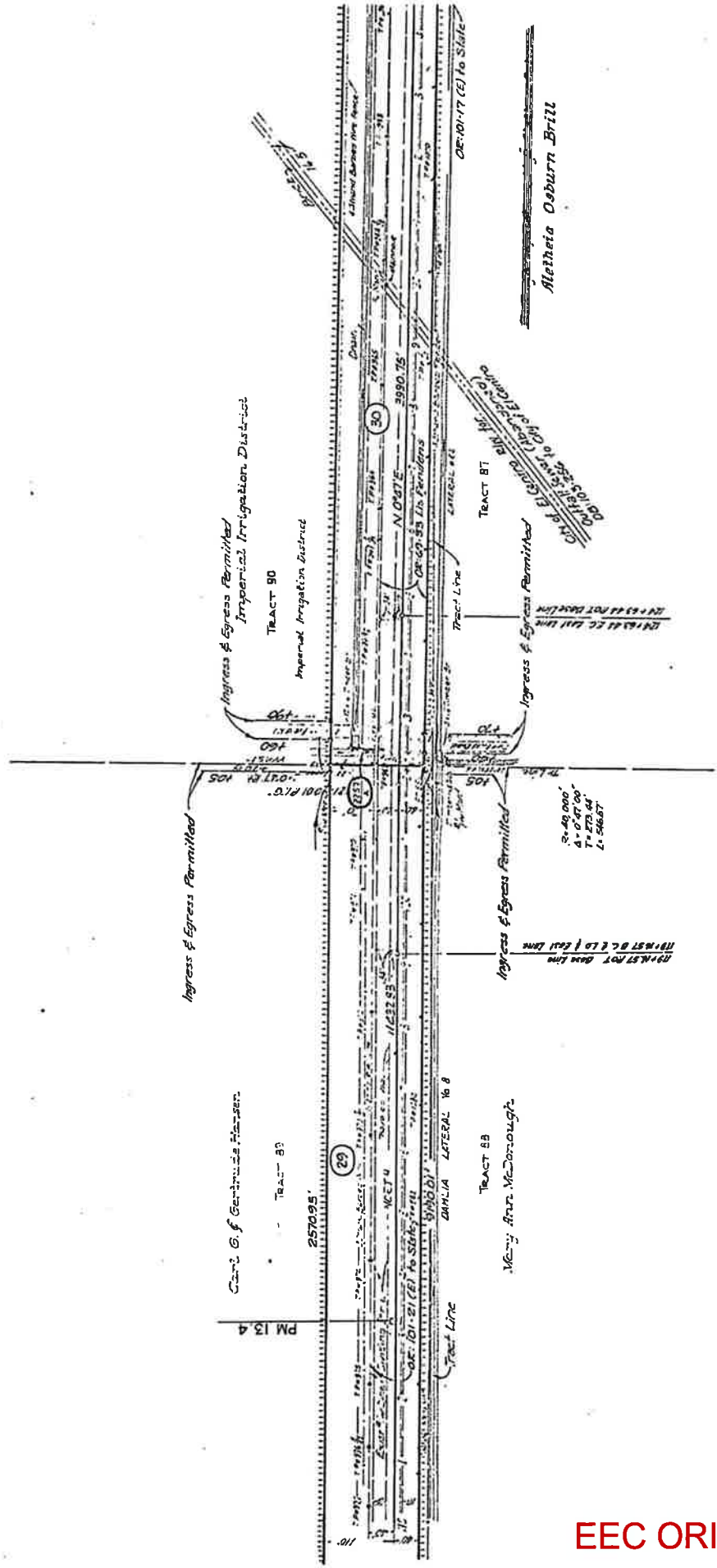

PAR. NO.	QUANTOR	TYPE INSTR.	DATE SIGNED	RECORDED	BOOK	PAGE	REMARKS
29	Carl G. Hansen, et al	(F)	1-30-44	2-15-45	632	386	1973 Access EAs.
30	Imperial Irr. District	(F)	1-30-45	3-3-45	632	498	2033 Access EAs.
55	D. Eugene Osburn, et al	(F)	12-2-44	6-20-45	643	106	2053 Access EAs.
65	Imperial Irr. Dist.	Joint Use Agreement	7-15-47	8-15-47	682	221	2257-1 Par. 5

FOR PREVIOUS R/W INFORMATION  
 SEE MAP NO. I-033, 034  
 I-047, 048  
**RIGHT OF WAY M**  
 SCALE 1" = 100'  
 10861301.tif 12-20-99  
 PM13.4  
 XI-IMP-86  
 L0-7  
 April 06

EEC ORIGINAL PKG



T. J. A. S. R. I. D. E. . . S. B. B. E. M.

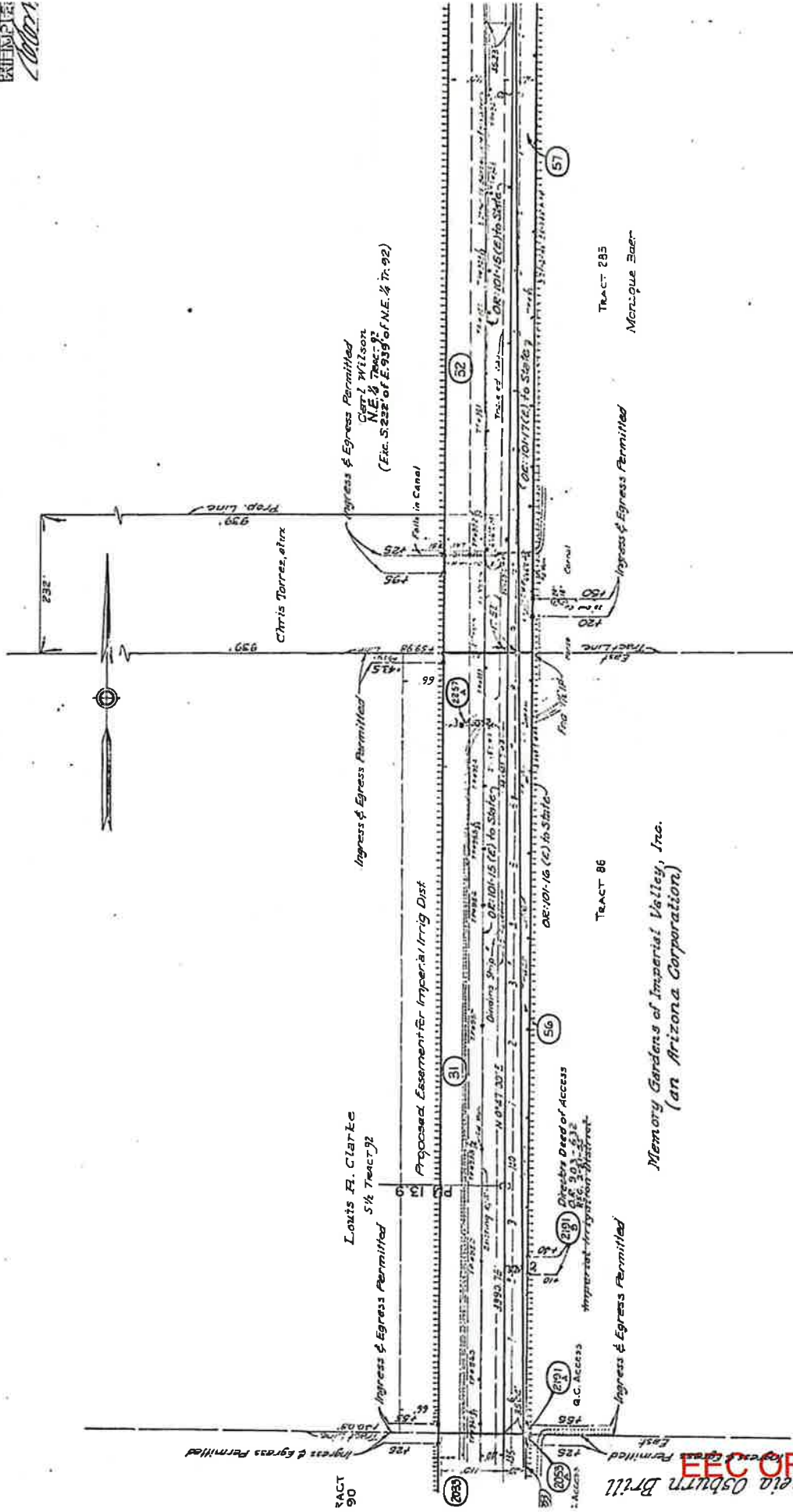

PAR. NO.	GRANTOR	TYPE INSTR.	DATE JOINED	RECORDED BOOK	PAGE	REMARKS
2037	Imperial Irr. Dist.	Grant	7-15-47	82	221	2257A Br. C
2038	Methelie Osburn Brill	Q.C.	10-14-54	2143	628	Access Eights
2039	Memory Gardens of Imperial Valley, Inc.	Q.C.	11-1-54	2150	690	Access Eights
2040	Memory Gardens of Imp Valley, Inc. Directors	Q.C.	2-4-55	2150	632	
2053	Imperial Irr. District	(F)	1-30-45	3-9-45	632	498 2039 Access Rts.
2055	D. Eugene Osborn	(F)	10-12-44	6-20-45	643	106 2053 Access Rts.
51	Louis R. Clarke Imperial Irr. Dist.	(F)	3-12-46	8-24-46	662	525 2184 Access Rts.
32	Carl Wilson	(F)	2-11-47	4-5-47	672	450 2257B Par. 2
56	Imperial Irr. Dist.	(F)	4-16-46	10-9-46	666	206 2185 Access Rts.
57	Monique Baer	(F)	11-5-46	6-30-47	678	551 2191 Access Rts.
57	Monique Baer	(F)	11-6-48	6-23-48	712	113 2192 Access Rts.

FOR PREVIOUS R/W INFORM  
SEE MAP NO. 1-034.0

**RIGHT OF WAY A**  
SCALE 1" = 100'  
10861302.R/W 12-20-99  
PM 13.9  
XI-IMP-86  
L.O.-7.  
-#448-86  
April '96

ORIGINAL COPY



UNITED STATES  
DEPARTMENT OF JUSTICE  
FEDERAL BUREAU OF INVESTIGATION

MEMORANDUM  
TO :

DATE: \_\_\_\_\_

FROM: \_\_\_\_\_

SUBJECT: \_\_\_\_\_

RE: \_\_\_\_\_

BY: \_\_\_\_\_

\_\_\_\_\_

\_\_\_\_\_

\_\_\_\_\_

\_\_\_\_\_

\_\_\_\_\_

\_\_\_\_\_

\_\_\_\_\_

\_\_\_\_\_

\_\_\_\_\_

**Tomcat Development LLC**  
224 S. 8<sup>th</sup> Street  
El Centro, CA 92243

## **Project Profile**

Date: 3-30-2022

**Name:** Green Valley Logistics Center

**Owner:** Tomcat Development LLC, a California limited liability company

**Location:** The area North of Dahlia Lateral 8, West of the Union Pacific Rail Road, East of SR-86 and South of IID Newside Drain No. 1-A in the Mesquite Lake Specific Plan Area of the unincorporated County of Imperial, California.

**Size:** Approximately 285 Gross Acres

**APNs:** 040-340-004, -006, -032 & -033

**Legal**

**Description:** Tracts 83, 84, 86 & 87, T 14S, R 14E in the Mesquite Lake Specific Plan area of the unincorporated County of Imperial, lying west of the Union Pacific Rail Road.

**CEQA**

**Lead Agency:** Imperial County Planning & Development Services

**County**

**Applications:**

1. Change of Zone for portion of site to ML – I-3
2. Specific Plan Amendment for portion of site to Heavy Industrial land use
3. Tentative Tract Map including grant of road right-of-way to Imperial County for 88' Industrial Collector
4. Conditional Use Permit application for Anaerobic Digestion

**Description:** The project site includes 2 proposed loop tracks that tie into the adjacent Union Pacific Rail Road right-of-way, including a ladder track ("rail system"). The rail system will facilitate in-bound and out-bound trains of commodities as well as transloading to and from trucks and warehousing. The project site includes the following table of uses:

**Tomcat Development LLC**  
 224 S. 8<sup>th</sup> Street  
 El Centro, CA 92243

<b>Table of Uses</b>			
<b>#</b>	<b>Use</b>	<b>Logistical Function</b>	<b>Net Area</b>
1	Existing Cemetery & Proposed Public Park	Regular vehicle traffic	~10 ac
2	Grain Elevator	Inbound rail-outbound truck	~10 ac
3	Hay Export & Container Depot	<b>Hay:</b> inbound truck-outbound rail <b>Containers:</b> inbound rail-outbound rail	~130ac
4	Produce Export	Inbound truck-outbound rail	~10 ac
5	Anaerobic Digester -Element A: biogas	Inbound trucks of manure	~10 ac
6	Anaerobic Digester -Element B: soil supplement	Outbound trucks of soil supplements	~10 ac
7	Fuel Blending / Transloading	Inbound rail-outbound truck	~5 ac
8	Fueling Station including but not limited to CNG	Trucks already on-site fuel up and public use	~5 ac
9	General Commodities: -Transloading/Warehousing	Inbound rail-outbound truck	~30 ac

The existing Memory Gardens Cemetery is part of the subject property and its property lines are being adjusted for inclusion of a public park facility in honor of veterans east of and adjacent to the cemetery. The cemetery and park will be fenced off from the balance of the project area, and access to the cemetery (and park) will be via the cemetery's existing and historical access from State Route 86.

The grain elevator is primarily for receiving corn and similar grain products via rail and distributing them to cattle feeding yards. The grain elevator and all other site uses (excluding the cemetery and public park) will have primary access via the new N-S running 88' Industrial Collector, which will connect to Harris Road south of the project site. The secondary emergency access points for the overall site are located along westerly project boundary. See attached preliminary site plan.

The remaining portion of the project area that is not occupied by the rail system, the grain elevator and the expanded cemetery property will be used for the transloading, storage and shipment of additional commodities, an anaerobic digester and a fueling station. Development standards and hours of operation on-site will be consistent with those of the Mesquite Lake Specific Plan and/or in accordance with Imperial County Planning & Development Services. The entire project area will drain into 1 communal storm water retention basin that connects to the IID Newside Drain No. 1-A.

**Utilities**

The project area will receive raw water service from Imperial Irrigation District (IID) and the project will include septic systems with leach fields in accordance with State and County standards. Raw water from IID will also be used for fire suppression purposes in accordance with County Fire Department standards. Potable water will be trucked-in

**Tomcat Development LLC**  
 224 S. 8<sup>th</sup> Street  
 El Centro, CA 92243

on-site and/or the project will develop treatment facilities that will treat IID raw water to a potable standard. Electrical service will be from IID and/or self-generated with solar panels, and natural gas will come from the SoCal Gas existing pipeline system on Keystone Road. The applicant will develop the necessary off-site improvements that are required to bring natural gas service to the project site. An output of the anaerobic digester will be renewable biogas, which will be pumped back into the SoCal Gas pipeline and/or pumped to the project's on-site CNG fueling station. The project will contract with third party utility companies for other utilities like telecom, internet and solid waste pick up services.

Over the last 10 years the project site has consumed approximately 630 acre-feet of water per year on average in order for 120 acres of the project site to be farmed. The proposed annual water usage for the project site once fully developed is shown in the following table:

<b>Proposed Water Use</b>		
<b>#</b>	<b>Project Element</b>	<b>Annual Amount</b>
1	Existing Cemetery & Proposed Public Park	3
2	Grain Elevator	3
3	Hay Export & Container Depot	3
4	Produce Export	2
5	Anaerobic Digester -Element A: biogas	1972
6	Anaerobic Digester -Element B: soil supplement	5
7	Fuel Blending / Transloading	1
8	Fueling Station including but not limited to CNG	1
9	General Commodities: -Transloading/Warehousing	5
<b>Total</b>		<b>~1,995</b>

**Traffic and Employees**

**Worker Vehicles**

Staffed operating hours for the facility are anticipated to be between the hours of 5AM and 7PM. A total of 56 on-site employees are expected each day; each driving their own vehicle (no carpooling assumed). To estimate the peak hour employee trips, two-shifts per day (5AM to 1PM, and 11AM to 7 PM) was assumed. Employees working either of these shifts would avoid the 7AM to 9AM morning commuter peak hour and the 4PM to 6PM afternoon commuter peak hour. Nevertheless, in order to provide a conservative analysis, 10% of the total employee ADT were assumed to enter the site (traveling inbound) during the AM peak, and 10% of the total employee ADT were assumed to exit the site (traveling outbound) during the PM peak.



**Tomcat Development LLC**  
 224 S. 8<sup>th</sup> Street  
 El Centro, CA 92243

**Heavy-Duty Trucks**

A total of 310 heavy-duty trucks are expected to access the site each day (60 grain elevator trucks, 50 fuel trucks, 30 beef cattle manure (inbound) / soil supplement (outbound) trucks, 70 hay export trucks, 95 trucks for miscellaneous commodities, and 5 trucks for locally grown produce). Heavy-duty trucks are assumed to access the site consistently between the hours of 5AM and 7PM. A Passenger Car Equivalence (PCE) of 2.0 was applied to account for the diminished performance characteristics of heavy trucks in traffic flow (as compared to passenger vehicles) based on data contained in the Highway Capacity Manual (HCM).

The following is the trip generation table for the project at full build-out of the site:

**TRIP GENERATION TABLE**

Number and Type of Trips	Daily Trips			AM Peak Hour (w/PCE)			PM Peak Hour (w/PCE)		
	ADT	PCE	PCE Adjusted ADT	In	Out	Total	In	Out	Total
56 Worker Vehicles	112	1.0	112	11	0	11	0	11	11
60 Grain Elevator Trucks	120	2.0	240	9	9	18	9	9	18
50 Fuel trucks	100	2.0	200	7	7	14	7	7	14
30 Manure (inbound) / Soil Supplement (outbound) Trucks	60	2.0	120	4	4	8	4	4	8
70 Hay Export Trucks	140	2.0	280	10	10	20	10	10	20
95 Commodities Trucks	190	2.0	380	14	14	28	14	14	28
5 Produce Trucks	10	2.0	20	1	1	2	1	1	2
<b>Total Trips:</b>			<b>1,352</b>	<b>56</b>	<b>45</b>	<b>101</b>	<b>45</b>	<b>56</b>	<b>101</b>

Note: the most traffic intensive construction phase of the project generates less trips than the fully built out operational project.

**SEE ATTACHED PRELIMINARY SITE PLAN**

# Green Valley Logistics Center

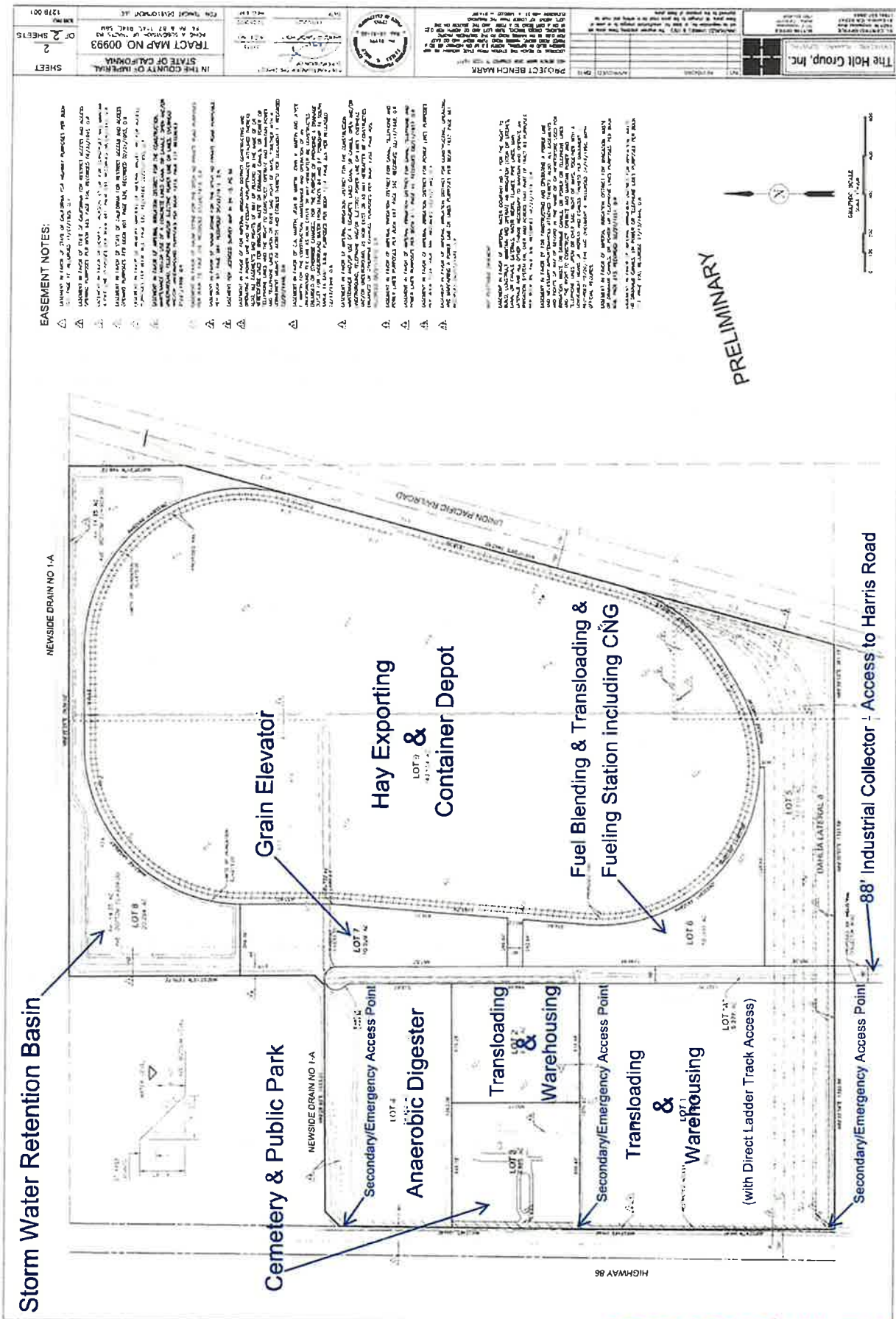

- EASEMENT NOTES:**
- 1. EASEMENT IN FAVOR OF STATE OF CALIFORNIA TO CONVEY WATER RIGHTS TO THE STATE OF CALIFORNIA TO BE USED FOR THE PURPOSES OF THE STATE WATER PROJECTS.
  - 2. EASEMENT IN FAVOR OF STATE OF CALIFORNIA TO CONVEY WATER RIGHTS TO THE STATE OF CALIFORNIA TO BE USED FOR THE PURPOSES OF THE STATE WATER PROJECTS.
  - 3. EASEMENT IN FAVOR OF STATE OF CALIFORNIA TO CONVEY WATER RIGHTS TO THE STATE OF CALIFORNIA TO BE USED FOR THE PURPOSES OF THE STATE WATER PROJECTS.
  - 4. EASEMENT IN FAVOR OF STATE OF CALIFORNIA TO CONVEY WATER RIGHTS TO THE STATE OF CALIFORNIA TO BE USED FOR THE PURPOSES OF THE STATE WATER PROJECTS.
  - 5. EASEMENT IN FAVOR OF STATE OF CALIFORNIA TO CONVEY WATER RIGHTS TO THE STATE OF CALIFORNIA TO BE USED FOR THE PURPOSES OF THE STATE WATER PROJECTS.
  - 6. EASEMENT IN FAVOR OF STATE OF CALIFORNIA TO CONVEY WATER RIGHTS TO THE STATE OF CALIFORNIA TO BE USED FOR THE PURPOSES OF THE STATE WATER PROJECTS.
  - 7. EASEMENT IN FAVOR OF STATE OF CALIFORNIA TO CONVEY WATER RIGHTS TO THE STATE OF CALIFORNIA TO BE USED FOR THE PURPOSES OF THE STATE WATER PROJECTS.
  - 8. EASEMENT IN FAVOR OF STATE OF CALIFORNIA TO CONVEY WATER RIGHTS TO THE STATE OF CALIFORNIA TO BE USED FOR THE PURPOSES OF THE STATE WATER PROJECTS.
  - 9. EASEMENT IN FAVOR OF STATE OF CALIFORNIA TO CONVEY WATER RIGHTS TO THE STATE OF CALIFORNIA TO BE USED FOR THE PURPOSES OF THE STATE WATER PROJECTS.
  - 10. EASEMENT IN FAVOR OF STATE OF CALIFORNIA TO CONVEY WATER RIGHTS TO THE STATE OF CALIFORNIA TO BE USED FOR THE PURPOSES OF THE STATE WATER PROJECTS.
  - 11. EASEMENT IN FAVOR OF STATE OF CALIFORNIA TO CONVEY WATER RIGHTS TO THE STATE OF CALIFORNIA TO BE USED FOR THE PURPOSES OF THE STATE WATER PROJECTS.
  - 12. EASEMENT IN FAVOR OF STATE OF CALIFORNIA TO CONVEY WATER RIGHTS TO THE STATE OF CALIFORNIA TO BE USED FOR THE PURPOSES OF THE STATE WATER PROJECTS.
  - 13. EASEMENT IN FAVOR OF STATE OF CALIFORNIA TO CONVEY WATER RIGHTS TO THE STATE OF CALIFORNIA TO BE USED FOR THE PURPOSES OF THE STATE WATER PROJECTS.
  - 14. EASEMENT IN FAVOR OF STATE OF CALIFORNIA TO CONVEY WATER RIGHTS TO THE STATE OF CALIFORNIA TO BE USED FOR THE PURPOSES OF THE STATE WATER PROJECTS.
  - 15. EASEMENT IN FAVOR OF STATE OF CALIFORNIA TO CONVEY WATER RIGHTS TO THE STATE OF CALIFORNIA TO BE USED FOR THE PURPOSES OF THE STATE WATER PROJECTS.
  - 16. EASEMENT IN FAVOR OF STATE OF CALIFORNIA TO CONVEY WATER RIGHTS TO THE STATE OF CALIFORNIA TO BE USED FOR THE PURPOSES OF THE STATE WATER PROJECTS.
  - 17. EASEMENT IN FAVOR OF STATE OF CALIFORNIA TO CONVEY WATER RIGHTS TO THE STATE OF CALIFORNIA TO BE USED FOR THE PURPOSES OF THE STATE WATER PROJECTS.
  - 18. EASEMENT IN FAVOR OF STATE OF CALIFORNIA TO CONVEY WATER RIGHTS TO THE STATE OF CALIFORNIA TO BE USED FOR THE PURPOSES OF THE STATE WATER PROJECTS.
  - 19. EASEMENT IN FAVOR OF STATE OF CALIFORNIA TO CONVEY WATER RIGHTS TO THE STATE OF CALIFORNIA TO BE USED FOR THE PURPOSES OF THE STATE WATER PROJECTS.
  - 20. EASEMENT IN FAVOR OF STATE OF CALIFORNIA TO CONVEY WATER RIGHTS TO THE STATE OF CALIFORNIA TO BE USED FOR THE PURPOSES OF THE STATE WATER PROJECTS.

PRELIMINARY



<p>TRACT MAP NO 00993          IN THE COUNTY OF IMPERIAL          STATE OF CALIFORNIA</p>		<p>PROJECT BENCH MARK</p>	
<p>SHEET 2          OF 2 SHEETS</p>	<p>FOR TRACT DISTRICT NO. 43</p>	<p>DATE: 11/11/2011</p>	<p>SCALE: 1" = 40'</p>

PRELIMINARY AND SUBJECT TO FINAL DESIGN







# VARIANCE

I.C. PLANNING & DEVELOPMENT SERVICES DEPT.  
801 Main Street, El Centro, CA 92243 (442) 265-1736

**- APPLICANT MUST COMPLETE ALL NUMBERED (black) SPACES -- Please type or print -**

1. PROPERTY OWNER'S NAME Tomcat Development LLC		EMAIL ADDRESS john@moiolabros.com	
2. MAILING ADDRESS (Street / P O Box, City, State) PO Box 177, Brawley, CA		ZIP CODE 92227	PHONE NUMBER 760-455-0399
3. ENGINEERS NAME	CA. LICENSE NO.	EMAIL ADDRESS	
4. MAILING ADDRESS (Street / P O Box, City, State)	ZIP CODE	PHONE NUMBER	
5. ASSESSOR'S PARCEL NO. 040-340-004, -006, -032, -033		ZONING (existing) ML GS, ML I-2 & ML I-3	
6. PROPERTY (site) ADDRESS 3320 State Route 86, Imperial, CA 92251		SIZE OF PROPERTY (in acres or square foot) 284 acres	
7. GENERAL LOCATION (i.e. city, town, cross street) Westerly portion of the Keystone Planning Area north of Harris Road and west of the Union Pacific Rail Road			
8. LEGAL DESCRIPTION Tracts 83, 84, 86 and 87 between SR 86 and the Union Pacific Rail Road in T 14S, R 14E in an unincorporated area of Imperial County within the Mesquite Lake Specific Plan Area a.k.a. Keystone Planning Area.			
8. DESCRIBE VARIANCE REQUESTED (i.e. side yard set-back reduction, etc.) A variance request for any structures over 80 feet, which would include the grain elevator system that will be up to 180 feet tall and comprised of up to eight large tanks/bins.			
9. DESCRIBE REASON FOR, OR WHY VARIANCE IS NECESSARY : A variance is necessary in order to develop an industry standard grain elevator and other site structures that are economically viable.			
10. DESCRIBE THE ADJACENT PROPERTY East Union Pacific rail road West SR-86 North Spreckles Sugar plant South Industrial zoned land			

I / WE THE LEGAL OWNER (S) OF THE ABOVE PROPERTY CERTIFY THAT THE INFORMATION SHOWN OR STATED HEREIN IS TRUE AND CORRECT.

John Moiola, Manager of Tomcat Development LLC 7-6-23  
 Print Name \_\_\_\_\_ Date \_\_\_\_\_  
 Signature \_\_\_\_\_  
 Print Name \_\_\_\_\_ Date \_\_\_\_\_  
 Signature \_\_\_\_\_

### REQUIRED SUPPORT DOCUMENTS

A. SITE PLAN	_____
B. FEE	_____
C. OTHER	_____
D. OTHER	_____

APPLICATION RECEIVED BY:	_____	DATE	_____	REVIEW / APPROVAL BY OTHER DEPT'S required. <input type="checkbox"/> P. W <input type="checkbox"/> E. H. S <input type="checkbox"/> A. P. C. D. <input type="checkbox"/> O. E. S. <input type="checkbox"/> _____ <input type="checkbox"/> _____
APPLICATION DEEMED COMPLETE BY:	_____	DATE	_____	
APPLICATION REJECTED BY:	_____	DATE	_____	
TENTATIVE HEARING BY:	_____	DATE	_____	
FINAL ACTION:	<input type="checkbox"/> APPROVED <input type="checkbox"/> DENIED	DATE	_____	

V #  
23-0007

# MAJOR SUBDIVISION

I.C. PLANNING & DEVELOPMENT SERVICES DEPT  
801 Main Street, El Centro, CA 92243 (760) 482-4236

- APPLICANT MUST COMPLETE ALL NUMBERED (black) SPACES - Please type or print -

1. PROPERTY OWNER'S NAME See Attachment due to having 3 Property Owners	EMAIL ADDRESS See Attachment due to having 3 Property Owners
2. MAILING ADDRESS See Attachment due to having 3 Property Owners	ZIP CODE See Attachment
3. ENGINEER'S NAME The Holt Group (Jack Holt)	CA. LICENSE NO. Civil PE# 31773
4. MAILING ADDRESS 1601 N. Imperial Avenue	PHONE NUMBER 760-337-3883
5. PROPERTY (site) ADDRESS See Attachment due to having 3 Property Owners	LOCATION See Attachment due to having 3 Property Owners
6. ASSESSOR'S PARCEL NO. See Attachment due to having 3 Property Owners	SIZE OF PROPERTY (in acres or square foot) See Attachment due to having 3 Property Owners
7. LEGAL DESCRIPTION (attach separate sheet if necessary) See Attachment due to having 3 Property Owners	
8. EXPLAIN PURPOSE/REASON FOR SUBDIVISION Rail accessible subdivision for the benefit of local agri-business products and others.	

9. Proposed DIVISION of the above specified land is as follows:

PARCEL	SIZE in acres or sq. feet	EXISTING USE	PROPOSED USE	ZONE
1 or A	See Attached.			
2 or B				
3 or C				
4 or D				

**PLEASE PROVIDE CLEAR & CONCISE INFORMATION (ATTACH SEPARATE SHEET IF NEEDED)**

10. DESCRIBE PROPOSED SEWER SYSTEM(s)	Septic with leach
11. DESCRIBE PROPOSED WATER SYSTEM	Service pipe connection to Dahlia Lateral B
12. DESCRIBE PROPOSED ACCESS TO MERGED PARCEL	A mix of access from SR-86, and Harris Road via an industrial collector - please see Tentative Tract Map
13. IS THIS PARCEL PLANNED TO BE ANNEXED? <input type="checkbox"/> Yes <input checked="" type="checkbox"/> No	IF YES, TO WHAT CITY or DISTRICT? N/A

I HEREBY APPLY FOR PERMISSION TO DIVIDE THE ABOVE SPECIFIED PROPERTY THAT I  OWN  CONTROL, AS PER ATTACHED INFORMATION, AND PER THE MAP ACT AND PER THE SUBDIVISION ORDINANCE.

I, CERTIFY THAT THE ABOVE INFORMATION, TO THE BEST OF MY KNOWLEDGE, IS TRUE AND CORRECT.

John Moiola for Tomcat Development LLC 11-16-2021  
Print Name (owner) Date

\_\_\_\_\_  
Signature (owner)

\_\_\_\_\_  
Print Name (Agent) Date

\_\_\_\_\_  
Signature (Agent)

**REQUIRED SUPPORT DOCUMENTS**

A. TENTATIVE MAP	_____
B. PRELIMINARY TITLE REPORT (6 months or newer)	_____
C. FEE	_____
D. OTHER	_____

**Special Note:**  
An notarized owners affidavit is required if application is signed by Agent.

APPLICATION RECEIVED BY:	_____	DATE	_____	REVIEW / APPROVAL BY	_____
APPLICATION DEEMED COMPLETE BY:	_____	DATE	_____	OTHER DEPT'S required.	_____
APPLICATION REJECTED BY:	_____	DATE	_____	<input type="checkbox"/> P. W.	_____
TENTATIVE HEARING BY:	_____	DATE	_____	<input type="checkbox"/> E. H. S.	_____
FINAL ACTION:	<input type="checkbox"/> APPROVED <input type="checkbox"/> DENIED	DATE	_____	<input type="checkbox"/> A. P. C. D.	_____
		DATE	_____	<input type="checkbox"/> O. E. S.	_____
		DATE	_____	<input type="checkbox"/> _____	_____
		DATE	_____	<input type="checkbox"/> _____	_____

**TR#**  
\_\_\_\_\_

## **Tentative Tract Map Application Attachment**

### **Property Owners (Sections 1, 2, 5, 6 & 7 County App):**

#### **1 – Tomcat Development LLC**

APNs 040-340-032 & -033

Mailing Address: 1594 Gonder Road, Brawley, CA

Email Address: john@moiolabros.com

Zip Code: 92227

Phone Number: 760-455-0399

#### **Legal Description:**

##### **PARCEL I:**

TRACT 86, TOWNSHIP 14 SOUTH, RANGE 14 EAST, S.B.M., IN AN UNINCORPORATED AREA OF THE COUNTY OF IMPERIAL, STATE OF CALIFORNIA, ACCORDING TO THE OFFICIAL PLAT THEREOF.

EXCEPTING THEREFROM THE SOUTH 660 FEET OF THE WEST 330 FEET THEREOF.

ALSO EXCEPTING THEREFROM THAT PORTION LYING WITHIN STATE HWY 86.

ALSO EXCEPTING THEREFROM THE FOLLOWING DESCRIBED PARCEL:

BEGINNING AT THE INTERSECTION OF THE EAST LINE OF HIGHWAY 99 WITH THE NORTH LINE OF TRACT 86; THENCE SOUTH 75 FEET; THENCE NORTHEASTERLY TO A POINT IN THE NORTH

LINE OF TRACT 86 WHICH IS 75 FEET EAST OF THE POINT OF BEGINNING; THENCE WEST 75 FEET TO SAID POINT OF BEGINNING, AS CONVEYED TO MONIQUE BAER, A SINGLE WOMAN IN INSTRUMENT RECORDED SEPTEMBER 22, 1964 AS INSTRUMENT NO. 96 OF OFFICIAL RECORDS.

**PARCEL II:**

THE SOUTH 660 FEET OF THE WEST 330 FEET OF TRACT 86, TOWNSHIP 14 SOUTH, RANGE 14 EAST, S.B.M., IN AN UNINCORPORATED AREA OF THE COUNTY OF IMPERIAL, STATE OF CALIFORNIA, ACCORDING TO THE OFFICIAL PLAT THEREOF.

EXCEPTING THEREFROM THAT PORTION LYING WITHIN HWY 86.

**PARCEL III:**

THE WEST 40 ACRES OF THE NORTH 80 ACRES OF TRACT 83, TOWNSHIP 14 SOUTH, RANGE 14 EAST, S.B.M., IN AN UNINCORPORATED AREA OF THE COUNTY OF IMPERIAL, STATE OF CALIFORNIA, ACCORDING TO THE OFFICIAL PLAT THEREOF.

**PARCEL IV:**

THAT PORTION OF TRACT 285, TOWNSHIP 14 SOUTH, RANGE 14 EAST, S.B.M., IN AN UNINCORPORATED AREA OF THE COUNTY OF IMPERIAL, STATE OF CALIFORNIA, ACCORDING TO THE OFFICIAL PLAT THEREOF, DESCRIBED AS FOLLOWS:

BEGINNING AT THE SOUTHEAST CORNER OF SAID TRACT 285; THENCE NORTH ALONG THE EAST LINE THEREOF, A DISTANCE OF 50 FEET; THENCE SOUTHWEST TO A POINT IN THE SOUTH LINE OF SAID TRACT 285 WHICH IS 50 FEET WEST FROM THE SOUTHEAST CORNER THEREOF; THENCE EAST ALONG THE SOUTH LINE THEREOF, 50 FEET TO THE POINT OF BEGINNING.

**2 – Van Groningen Living Trust – Trustees: Roger & Larinda Van Groningen  
APN 040-340-006**

**Mailing Address:** 8000 East Manning, Fowler, CA

**Email Address:** roger@vanglogistics.com

**Zip Code:** 93625-9727

**Phone Number:** 559-834-4389

**Legal Description:**

Those portions of the South half (S 1/2) and the East half (E 1/2) of the North half (N 1/2) of Tract 83, Township 14 South, Range 14 East, S.B.M., in an unincorporated area of the County of Imperial, State of California, according to the Official Plat thereof, lying West of the railroad right of way.



**3 – Ronald Martin (1/2); &  
Beverly A. Martin Revocable Trust UDT dated December 28, 2010 (1/2)  
APN 040-340-004**

Mailing Address: 4431 Monaco Street, San Diego, CA

Email Address: steve@sgmartincpa.com

Zip Code: 92107

Phone Number: 619-857-2391

**Legal Description:**

Tracts 84 and 87, Township 14 South, Range 14 East, S.B.M., in an unincorporated area of the County of Imperial, State of California, according to the Official Plat thereof.

Excepting therefrom that portion thereof granted to the State of California by deed recorded June 20, 1945 in book 643, page 106 of Official Records.

**Proposed Division of the Subject Property (Section 9 of County App):**

**Parcel 1:**

Size – 38.697 acres

Existing Use – industrial land currently being farmed

Proposed Use – Commodity Transloading & Storage

Zone – Proposed ML – I-3

**Parcel 2:**

Size – 9.342 acres

Existing Use – Vacant industrial land

Proposed Use – Commodity Transloading & Storage

Zone – Proposed ML – I-3

**Parcel 3:**

Size – 9.865 acres

Existing Use – Cemetery & vacant industrial land

Proposed Use – Cemetery and veteran memorial park

Zone – Proposed ML – I-3

**Parcel 4:**

Size – 18.952 acres  
Existing Use – Vacant industrial land  
Proposed Use – Commodity Transloading & Storage  
Zone – Proposed ML – I-3

**Parcel 5:**

Size – 17.310 acres  
Existing Use – Industrial land – portion farmed & portion vacant  
Proposed Use – Commodity Transloading & Storage  
Zone – Proposed ML – I-3

**Parcel 6:**

Size – 10.00 acres  
Existing Use – Industrial land currently being farmed  
Proposed Use – Commodity Transloading & Storage  
Zone – Proposed ML – I-3

**Parcel 7:**

Size – 10.029 acres  
Existing Use – Industrial land – portion farmed & portion vacant  
Proposed Use – Commodity Transloading & Storage  
Zone – Proposed ML – I-3

**Parcel 8:**

Size – 20.294 acres  
Existing Use – Vacant industrial land  
Proposed Use – Storm Water Retention Basin  
Zone – Proposed ML – I-3

**Parcel 9:**

Size – 143.554 acres  
Existing Use – Vacant industrial land  
Proposed Use – Commodity Transloading & Storage  
Zone – Proposed ML – I-3

NO.	REVISIONS

**PROJECT BENCH MARK**  
 ALL DIMENSIONS ARE TO THE CENTERLINE OF THE ROAD UNLESS OTHERWISE NOTED.  
 ALL DIMENSIONS ARE TO THE CENTERLINE OF THE ROAD UNLESS OTHERWISE NOTED.  
 ALL DIMENSIONS ARE TO THE CENTERLINE OF THE ROAD UNLESS OTHERWISE NOTED.

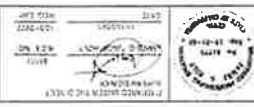

**PRELIMINARY**

- EASEMENT NOTES:**
1. THE TRACT MAP NO. 00993 IS A TRACT MAP OF THE TRACTS DESCRIBED IN THE TRACT MAP NO. 00993.
  2. THE TRACT MAP NO. 00993 IS A TRACT MAP OF THE TRACTS DESCRIBED IN THE TRACT MAP NO. 00993.
  3. THE TRACT MAP NO. 00993 IS A TRACT MAP OF THE TRACTS DESCRIBED IN THE TRACT MAP NO. 00993.
  4. THE TRACT MAP NO. 00993 IS A TRACT MAP OF THE TRACTS DESCRIBED IN THE TRACT MAP NO. 00993.
  5. THE TRACT MAP NO. 00993 IS A TRACT MAP OF THE TRACTS DESCRIBED IN THE TRACT MAP NO. 00993.
  6. THE TRACT MAP NO. 00993 IS A TRACT MAP OF THE TRACTS DESCRIBED IN THE TRACT MAP NO. 00993.
  7. THE TRACT MAP NO. 00993 IS A TRACT MAP OF THE TRACTS DESCRIBED IN THE TRACT MAP NO. 00993.
  8. THE TRACT MAP NO. 00993 IS A TRACT MAP OF THE TRACTS DESCRIBED IN THE TRACT MAP NO. 00993.
  9. THE TRACT MAP NO. 00993 IS A TRACT MAP OF THE TRACTS DESCRIBED IN THE TRACT MAP NO. 00993.
  10. THE TRACT MAP NO. 00993 IS A TRACT MAP OF THE TRACTS DESCRIBED IN THE TRACT MAP NO. 00993.
  11. THE TRACT MAP NO. 00993 IS A TRACT MAP OF THE TRACTS DESCRIBED IN THE TRACT MAP NO. 00993.
  12. THE TRACT MAP NO. 00993 IS A TRACT MAP OF THE TRACTS DESCRIBED IN THE TRACT MAP NO. 00993.
  13. THE TRACT MAP NO. 00993 IS A TRACT MAP OF THE TRACTS DESCRIBED IN THE TRACT MAP NO. 00993.
  14. THE TRACT MAP NO. 00993 IS A TRACT MAP OF THE TRACTS DESCRIBED IN THE TRACT MAP NO. 00993.
  15. THE TRACT MAP NO. 00993 IS A TRACT MAP OF THE TRACTS DESCRIBED IN THE TRACT MAP NO. 00993.
  16. THE TRACT MAP NO. 00993 IS A TRACT MAP OF THE TRACTS DESCRIBED IN THE TRACT MAP NO. 00993.
  17. THE TRACT MAP NO. 00993 IS A TRACT MAP OF THE TRACTS DESCRIBED IN THE TRACT MAP NO. 00993.
  18. THE TRACT MAP NO. 00993 IS A TRACT MAP OF THE TRACTS DESCRIBED IN THE TRACT MAP NO. 00993.
  19. THE TRACT MAP NO. 00993 IS A TRACT MAP OF THE TRACTS DESCRIBED IN THE TRACT MAP NO. 00993.
  20. THE TRACT MAP NO. 00993 IS A TRACT MAP OF THE TRACTS DESCRIBED IN THE TRACT MAP NO. 00993.

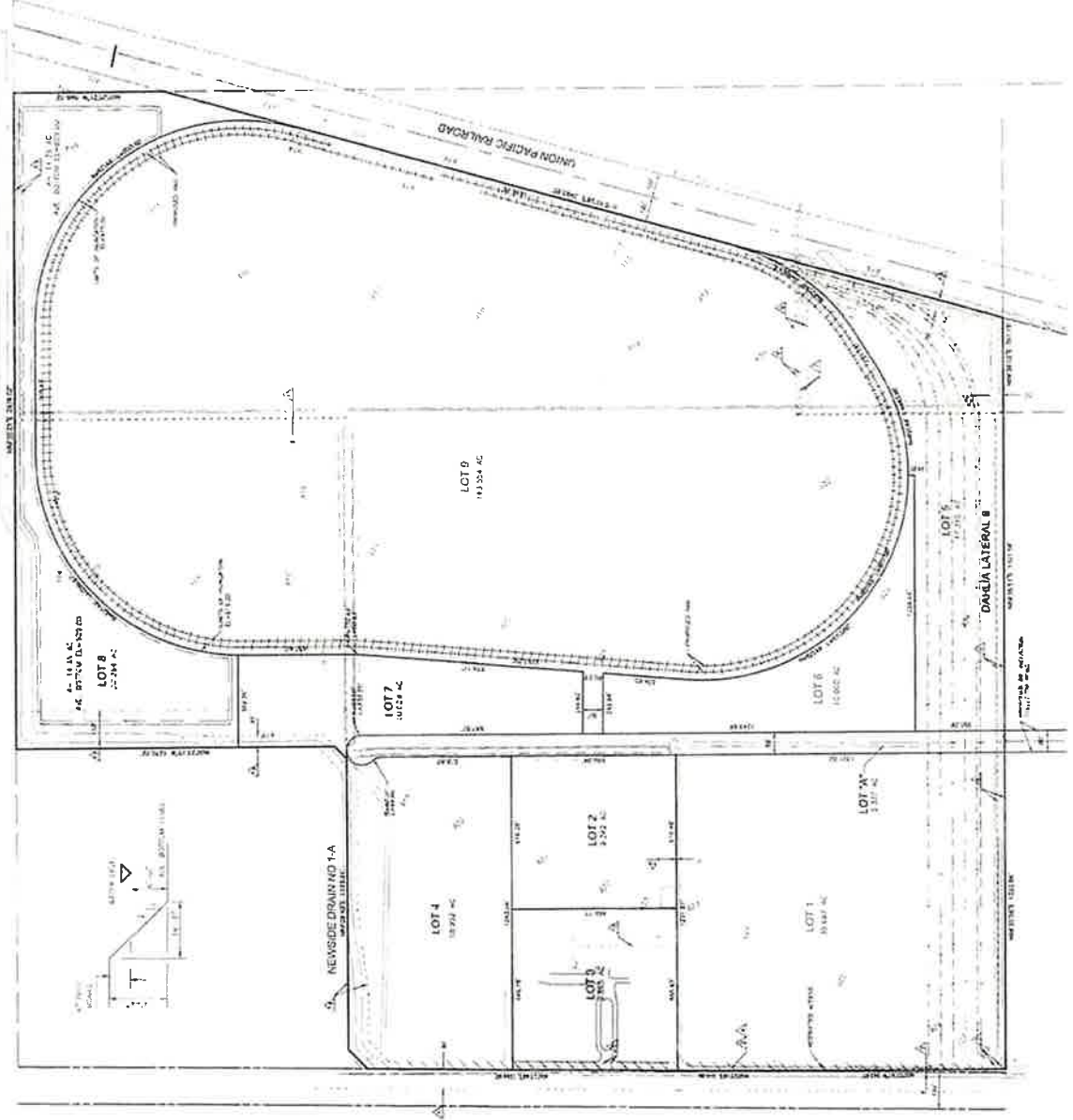

HIGHWAY 66

# **AIR QUALITY ASSESSMENT**

## **Green Valley Logistics Center Project County of Imperial**

**Prepared for:**

**Chambers Group, Inc.  
5 Hutton Centre Dr, Suite 350  
Santa Ana, CA 92707**

**Prepared by:**

***Ldn Consulting, Inc.***  
**42428 Chisolm Trail  
Murrieta, CA 92562**

**July 18, 2023**



## **TABLE OF CONTENTS**

<b>TABLE OF CONTENTS</b> .....	<b>II</b>
<b>LIST OF FIGURES</b> .....	<b>III</b>
<b>LIST OF TABLES</b> .....	<b>III</b>
<b>APPENDIX</b> .....	<b>III</b>
<b>LIST OF COMMON ACRONYMS</b> .....	<b>IV</b>
<b>1.0 INTRODUCTION</b> .....	<b>1</b>
1.1 PURPOSE OF THIS STUDY .....	1
1.2 PROJECT LOCATION .....	1
1.3 PROJECT DESCRIPTION .....	1
<b>2.0 EXISTING ENVIRONMENTAL SETTING</b> .....	<b>13</b>
2.1 EXISTING SETTING .....	13
2.2 CLIMATE AND METEOROLOGY .....	13
2.3 REGULATORY STANDARDS.....	14
2.3.1 FEDERAL STANDARDS AND DEFINITIONS .....	14
2.3.2 STATE STANDARDS AND DEFINITIONS.....	15
2.3.3 REGIONAL STANDARDS.....	17
2.4 CALIFORNIA ENVIRONMENTAL QUALITY ACT (CEQA) SIGNIFICANCE THRESHOLDS .....	18
2.5 ICAPCD AIR QUALITY IMPACT ASSESSMENT SCREENING THRESHOLDS (CEQA).....	18
2.6 LOCAL AIR QUALITY.....	20
<b>3.0 METHODOLOGY</b> .....	<b>22</b>
3.1 CONSTRUCTION EMISSIONS CALCULATIONS.....	22
3.2 CONSTRUCTION ASSUMPTIONS.....	26
3.3 OPERATIONAL EMISSIONS.....	28
3.4 TRAIN ACTIVITIES .....	29
3.5 ODOR IMPACTS (ONSITE) .....	30
<b>4.0 FINDINGS</b> .....	<b>31</b>
4.1 CONSTRUCTION FINDINGS .....	31
4.2 CONSTRUCTION HEALTH RISKS .....	32
4.3 OPERATIONAL FINDINGS.....	33
4.4 OPERATIONAL HEALTH RISKS.....	34
4.5 CUMULATIVE IMPACT FINDINGS.....	35
4.6 CONCLUSION OF FINDINGS.....	35
<b>6.0 REFERENCES</b> .....	<b>38</b>
<b>7.0 CERTIFICATIONS</b> .....	<b>39</b>

## List of Figures

FIGURE 1-A: PROJECT VICINITY MAP .....	3
FIGURE 1-B: PROPOSED PROJECT SITE LAYOUT .....	4
FIGURE 1-C: PROJECT TRIP GENERATION .....	11
FIGURE 3-A: CONSTRUCTION HEALTH RISK MODEL SETUP.....	25
FIGURE 3-B: 2020 CALIFORNIA LOCOMOTIVE POPULATION BY TIER .....	30

## List of Tables

TABLE 1.1: PROPOSED USES .....	2
TABLE 2.1: AMBIENT AIR QUALITY STANDARDS .....	16
TABLE 2.2: IMPERIAL COUNTY AIR BASIN ATTAINMENT STATUS BY POLLUTANT .....	17
TABLE 2.3: SCREENING THRESHOLD FOR CRITERIA POLLUTANTS .....	19
TABLE 2.4: THREE-YEAR AMBIENT AIR QUALITY DATA.....	21
TABLE 3.1: EXPECTED CONSTRUCTION EQUIPMENT .....	27
TABLE 3.2: LINE-HAUL EMISSION FACTORS (G/BHP-HR).....	29
TABLE 4.1: EXPECTED CONSTRUCTION EMISSIONS WITHOUT MITIGATION – LB/DAY .....	31
TABLE 4.2: EXPECTED CONSTRUCTION EMISSIONS WITH MITIGATION – LB/DAY .....	32
TABLE 4.3: EXPECTED RAIL EMISSIONS .....	33
TABLE 4.4: EXPECTED DAILY POLLUTANT GENERATION - SUMMER.....	34
TABLE 4.5: EXPECTED DAILY POLLUTANT GENERATION - WINTER.....	34

## Appendix

CALEEMOD (UNMITIGATED) .....	40
CALEEMOD (MITIGATED) .....	135
AERMOD FOR ONSITE CONSTRUCTION PM <sub>10</sub> - DPM .....	230
CONSTRUCTION HEALTH RISK CALCULATIONS.....	238

## **LIST OF COMMON ACRONYMS**

Air Quality Impact Assessments (AQIA)  
Assembly Bill 32 (AB32)  
California Air Resource Board (CARB)  
California Ambient Air Quality Standards (CAAQS)  
California Environmental Quality Act (CEQA)  
Carbon Dioxide (CO<sub>2</sub>)  
Cubic Yards (CY)  
Diesel Particulate Matter (DPM)  
Environmental Protection Agency (EPA)  
EPA Office of Air Quality Planning and Standards (OAQPS)  
Hazardous Air Pollutants (HAPs)  
Hydrogen Sulfide (H<sub>2</sub>S)  
Imperial County Air Pollution Control District (ICAPCD)  
International Residential Code (IRC)  
Level of Service (LOS)  
Low Carbon Fuel Standard (LCFS)  
Methane (CH<sub>4</sub>)  
National ambient air quality standards (NAAQS)  
Nitrous Oxide (N<sub>2</sub>O)  
North County Transit District (NCTD)  
Reactive Organic Gas (ROG)  
Regional Air Quality Strategy (RAQS)  
Salton Sea Air Basin (SDAB)  
South Coast Air Quality Management District (SCAQMD)  
Specific Plan Area (SPA)  
State Implementation Plan (SIP)  
Toxic Air Contaminants (TACs)  
Vehicle Miles Traveled (VMT)

## **1.0 INTRODUCTION**

### **1.1 Purpose of this Study**

The purpose of this Air Quality analysis is to determine potential air quality impacts (if any) that may be created by construction, area or operational emissions (short term or long term) from the proposed Project. Should impacts from the proposed project be determined, the intent of this study would be to recommend suitable mitigation measures to bring those impacts to a level that would be considered less than significant.

### **1.2 Project Location**

The Project is located on approximately 285 gross acres within Imperial County, California, approximately 1.25 miles north of the City of Imperial. The Project is west of the Union Pacific Railroad (UPRR), east of SR 86 (Imperial Avenue), north of Harris Road, and south of Newside Drain Number 1-A. The Project is entirely within the Mesquite Lake Specific Plan on land owned by Tomcat Development LLC. The Project is within Section 31 of Township 14 South, Range 14 East, San Bernardino Base Meridian on APNs 040-340-004, 040-340-006, 040-340-032 and 040-340-033.

The Project will be accessed from new right in and right out driveways on State Route 86 and two secondary/emergency access points along SR 86, will also be provided. The cemetery and memorial area will be accessed via the existing historical SR 86 access, or from the frontage road between the 2 new driveways on SR 86

The Project area is zoned Mesquite Lake Specific Plan, including ML GS (Mesquite Lake Government / Special Public), ML I-2 (Mesquite Lake Medium Industrial) and ML I-3 (Mesquite Lake Heavy Industrial), with a Renewable Energy Overlay Zone. The General Plan Land Use designation for the entire Project is Mesquite Lake Specific Plan. A general project vicinity of the proposed Project is shown in Figure 1-A.

### **1.3 Project Description**

The Project would allow for the development and operation of three (3) rail loop tracks totaling approximately 33,000 track feet, a rail ladder track totaling approximately 25,000 track feet, and an approximately 2,000 track feet spur that tie into the adjacent Union Pacific Railroad Right of Way (ROW) ('rail system').

The rail system will facilitate inbound and outbound trains of commodities as well as the transloading of commodities to and from trucks. Also included in the Project are a grain



elevator; shipping container depot, a fuel blending / transloading area; a fueling station, warehousing and a veteran’s memorial area adjacent to the existing cemetery. The Project would also provide an extension to the SoCal Gas line from Keystone Road approximately 1.3 miles along State Route 86 to the Project Site.

Finally, the Project seeks a specific plan amendment and zone change from Light and Medium Industrial to Heavy Industrial. The plan requires a re-configuration of the existing parcels and would include a road right-of way grant to the County of Imperial. The proposed uses are listed in Table 1.1. The project site plan is shown in Figure 1-B.

**Table 1.1: Proposed Uses**

Use	Logistical Function / Description	Approximate Area (acres)
Existing Cemetery and Memorial Area	Regular Vehicle Traffic	10
Grain Elevator System	Inbound Rail – Outbound Truck for Corn/Grain Distribution to Cattle Feeder Yards	10
Centralized Water Treatment & Storage System	Provide Potable & Fire Water to the Project Area	2
Hay and Grain Export and Container Depot	Hay/Grain: Inbound Truck – Outbound Rail Containers: Inbound Rail – Outbound Rail and Truck	144
Produce / Food Export Transloading/Warehouse	Inbound Truck – Outbound Rail	10
Fuel Blending / Transloading	Inbound Rail – Outbound Truck	10
Fueling Station, including but not Limited to CNG	Trucks Already On-Site Fuel Up and Public Use	9.5
General Commodities: Transloading/Warehouse	Inbound Rail – Outbound Truck	64
Storm Water Retention Basin	Project Hydrology Program	19
Circulation	On-site Project Roadway	6
<b>Total</b>		<b>284.5</b>

**Figure 1-A: Project Vicinity Map**

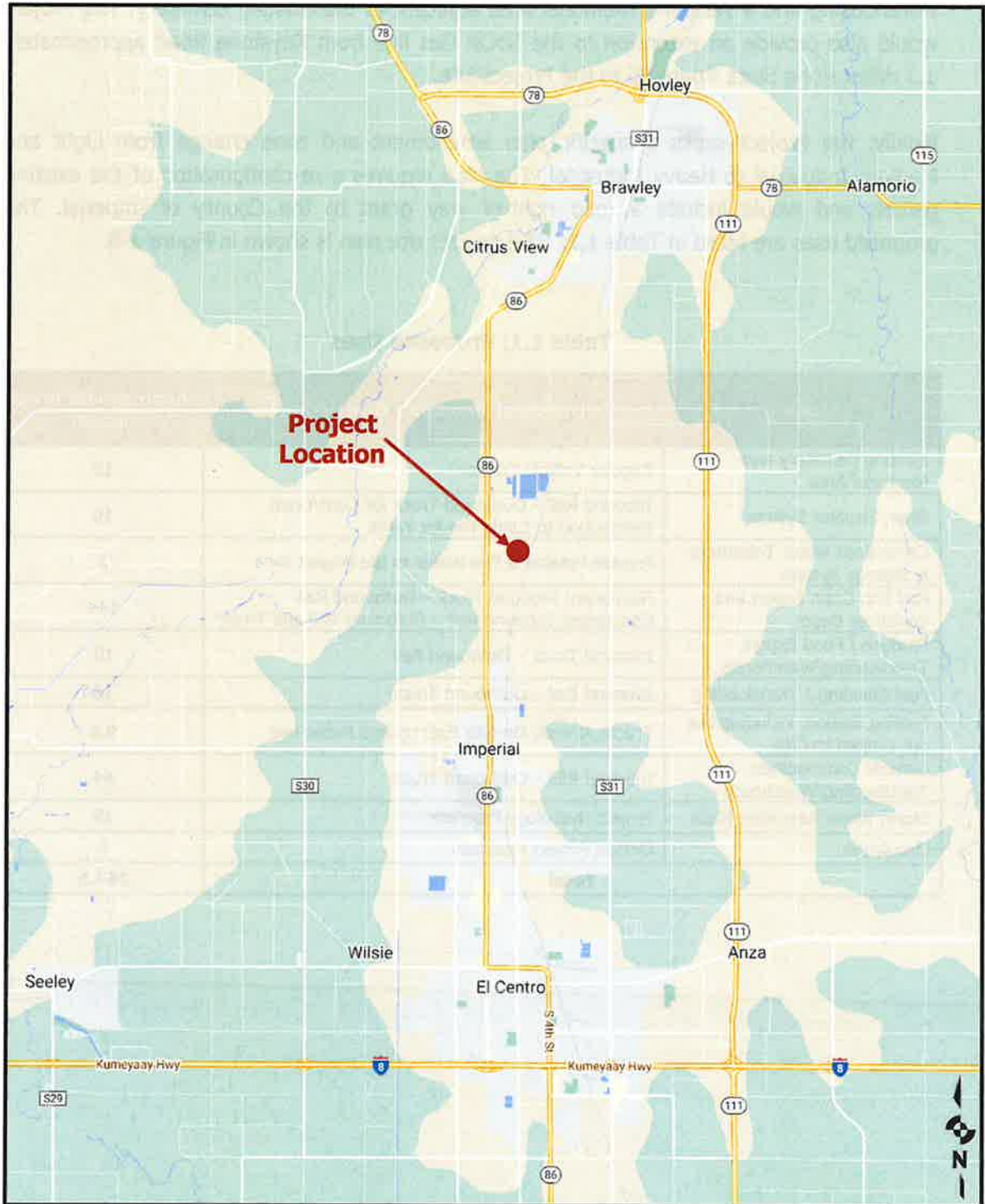

Source: (Google, 2023)

**Figure 1-B: Proposed Project Site Layout**

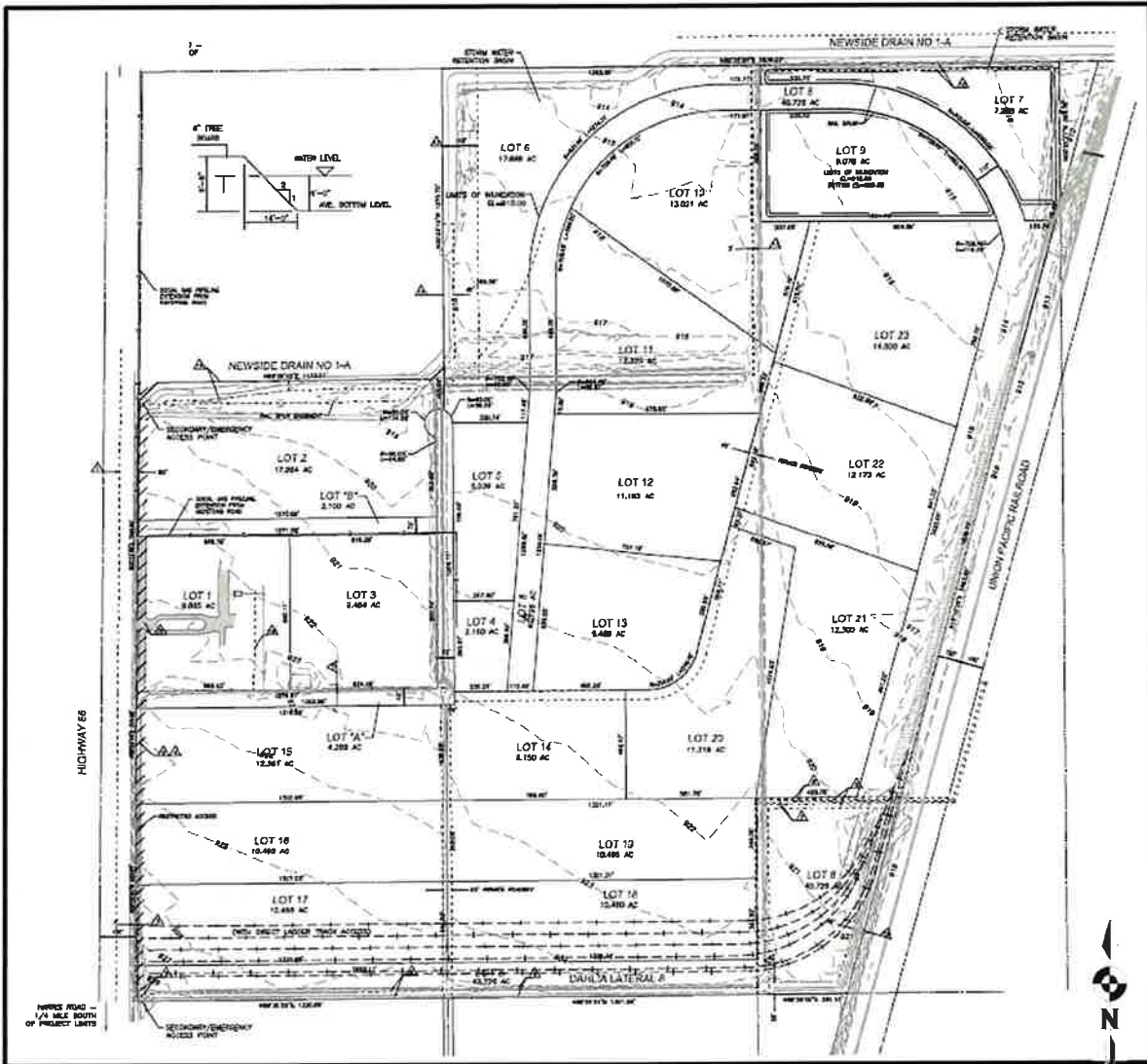

Source: (The Holt Group, 2023)

## **Project Construction**

Construction of the Project is expected to begin sometime in 2024 and would continue for approximately 18 months if the site is built-out under a single construction effort. Site preparation is anticipated to take approximately 2 months, grading to take approximately 2 months, and vertical construction to occur over approximately 14 months. Project build-out is expected in 2026. It should be noted depending on market demands, the Project construction may occur incrementally over time though analysis under a single effort is considered worst case.

Site preparation will include clearing and grubbing which would require export to local recycling area. The land development includes grading to create rough graded streets, native soil preparatory work for track facilities, and pads for new construction. The site preparation will include an estimated 150,000 cubic yards (CY) of cut and 150,000 CY of fill; soil will be balanced on site.

The Project would require material imports which would include 140,000 CY of granular select fill for use underneath concrete building pads, an import of approximately 315,000 tons of ballast or 410,000 CY of material to construct the Project tracks and 28,000 tons or 32,000 CY of road base for the Industrial Street roadway, which will be surface finished with asphalt concrete. In all, the Project would import 582,000 CY of material and export roughly 1,000 CY of grubbed material.

A concrete and rebar bridge/over-pass or a culvert/under-pass may ultimately be built in order to take trucks to and from the inside of the loop tracks. Prior to the full loop tracks being constructed, a private roadway will be constructed for access to the central part of the Project.

## **Project Operations**

Routine operations and maintenance of the facility will include preventative maintenance and repairs of any damaged or otherwise inoperable equipment on an as-needed basis. The operation and maintenance staff will monitor the facility operations over the Project life to ensure that the logistics center is operating to meet design standards. Approximately 56 full-time employees are expected each day of the week during Project operations to cover all uses identified in Table 1 above and described below. The Project operations would require two shifts per day.

### Existing Cemetery and Memorial Area

The existing Memory Gardens Cemetery is part of the subject property and has existing water and electrical service from the Imperial Irrigation District. The property lines around the existing 7-acre cemetery are being adjusted for inclusion of a memorial area in honor of veterans east of and adjacent to the cemetery and the new cemetery overall area will be approximately 10 acres in total.

The cemetery and memorial area will be fenced-off from the remaining portion of the Project area with either chain link and privacy slats, wood, or vinyl fencing. Access to the cemetery (and memorial area) will be via the cemetery's existing and historical access from SR 86.

Improvements at the memorial area would consist of landscaping and lighting consistent with Mesquite Lake Specific Plan and County Planning & Development Services requirements.

Raw water is currently provided from the IID Dahlia Lateral 8 and such service will be continued in the future. Volunteers currently maintain the cemetery and will continue to do so in the future, likely under the ownership and management of a newly formed non-profit entity. The existing cemetery has approximately 20 vehicles coming on-site per day and an Average Daily Traffic (ADT) of 40 and no increase in traffic is expected to occur.

### Grain Elevator System

The grain elevator is primarily for receiving corn and similar grain products via rail and distributing them to cattle feeding yards. The grain elevator system will be up to 180 feet tall and be comprised of up to four (4) large tanks/bins initially, expanding to a total of eight (8) large tanks/bins, and several ancillary mechanical components and will be built on a parcel that is approximately 10 acres. The grain elevator would receive approximately 450,000 tons (40-unit trains) of corn annually and approximately 150,000 tons (20 trains) of Dried Distillers Grain (DDG) annually via the proposed tracks. This portion of the Project would employ approximately eight people split between approximately two shifts per day (5am to 1pm and 11am to 7pm).

UPRR unit trains are currently 110 rail cars in length; however, the rail industry is moving to expand unit rail length to approximately 126 cars. The DDG would come into the site via approximately 75-car trains and may come in via the loop tracks or via the ladder tracks south of and adjacent to, the loop tracks. Grain such as corn and DDG may also be brought to the site by Union Pacific in smaller blocks such as 30 to 50 rail cars. Approximately 60



grain elevator trucks with an ADT of 120 would be required per day to take feed to customers.

#### Centralized Water Treatment, Storage & Distribution System

The Project will include a water treatment, storage and distribution system that will satisfy potable water and fire water requirements. The system will receive water from the IID Dahlia Lateral 8 canal located along the southerly boundary of the Project. The treatment, storage and pump elements of the system will be located on the approximately 2-acre Lot 10 shown on Figure 4. The distribution element of the system will be a looped pressurized water line that will provide access to water for all Project parcels. The water treatment, storage and distribution system will likely be developed in phases with an initial phase having a storage capacity of approximately 180,000 gallons and a built-out storage capacity of up to 1.5 million gallons. A 1.5 million gallon tank would be approximately 50 feet tall and approximately 100 feet in diameter. During initial operations and prior to the need for a public water system, the applicant may truck-in purified/potable water.

#### Hay and Grain Export and Container Depot

The area in the middle of the loop tracks will be used primarily as a shipping container depot and for exporting hay and grain products via UPRR. The hay and grain export and container depot would employ approximately 12 people split between approximately two shifts per day (5am to 1pm and 11am to 7pm). Hay and grain trucks each carrying approximately twenty-five (25) containerized tons would be required per day to bring inbound hay and grain to the facility where it would be railed to the Ports of Los Angeles and Long Beach. The hay and grain would be grown within the irrigated area of Imperial County and brought to the site intermittently during hours of operation.

Ocean shipping containers would arrive on-site via UPRR from the Ports of Los Angeles and Long Beach full of miscellaneous products from overseas that are destined for distribution throughout the United States and Mexico. The miscellaneous products from overseas would be sorted and placed into domestic shipping containers for out-bound shipment via UPRR to major metropolitan hubs throughout the United States. In addition, full containers of miscellaneous products from the Ports of Los Angeles and Long Beach would arrive on-site via UPRR and be transloaded to truck for delivery to Mexico.

### Produce / Food Export

The produce export function would employ approximately six people split between approximately two shifts per day (5am to 1pm and 11am to 7pm). Produce would be trucked in on-site from locally grown sources, maybe temperature treated (cold storage prior to customer shipment) and would be exported via UPRR to domestic and international customers. Such produces would likely consist of the following: (a) Broccoli: 45,000 tons, (b) Cabbage: 26,000 tons, (c) Carrot: 128,000 tons, (d) Cauliflower: 77,000 tons, (e) Cantaloupe: 120,000 tons, (f) Citrus: 2,000 tons, (g) Onion: 110,000 tons, and (f) beef: 42,000 tons.

Produce and food grown outside of the County would be railed into the County via UPRR, sorted, stored and shipped to Mexico via truck. Such produce and food would likely consist of the following: (a) Apples, Onions and Potatoes: 35,000 tons, (b) Dry food goods : 20,000 tons, (c) Palletized food products packaged in cans : 25,000 tons, (d) Frozen pork : 145,000 tons, (e) Frozen poultry : 160,000 tons, and (f) Processed food grain corn in super sacks : 20,000 tons.

### Fuel Blending / Transloading

Fuel products will be railed in on-site and transloaded/blended for outbound movement via truck to off-site locations, including Mexico. The approximate amount of fuel that will be annually transloaded/blended at the Project are as follows: (a) Biodiesel fuel: 130,000,000 gallons, (b) Regular diesel: 50,000,000 gallons, and (c) Liquefied Petroleum Gas (LPG)/Natural Gas Liquids (NGL): 90,000,000 gallons. The facility would have the ability to store up to 2,000,000 gallons of fuel on-site via up to four (4) above ground tanks.

### Fueling Station Including CNG

The fueling station would be used to fuel vehicles and trucks on site. The approximate amount of fuel sold from the fueling station on an annual basis is as follows: (a) Unleaded fuel: 2,500,000 gallons, (b) Diesel: 4,750,000 gallons, (c) CNG: 5,500,000 gallons. Electric vehicles and hydrogen fuel cell vehicles will also be able to fill up at the fueling station. There would also be truck scales on-site at the fueling station and throughout the rest of the Project site as well as an approximately 30,000 square foot travel center area. The SoCal Gas pipeline that is being extended to the Project site approximately 1.3 miles along State Route 86 from Keystone Road would supply gas to the CNG fueling component of the fueling station.

### General Commodities: Transloading/Warehousing

The remaining portion of the Project area that is not occupied by the rail system and above-mentioned Project elements will be used for the transloading, storage and shipment of additional commodities. The approximate types and amounts of general commodities being transloaded/warehoused on an annual basis on site is as follows: (a) Lumber: 150,000 tons, (b) Fertilizers: 30,000 tons, (c) Plastics: 60,000 tons, (d) Rolled Steel: 85,000 tons, (e) 35% Hydrochloric Acid: 60,000 tons, (f) 50% Caustic Soda: 40,000 tons, (g) 95% Sulfuric Acid: 25,000 tons and (h) Paper: 50,000 tons. Transloading/warehousing of general commodities would employ approximately 18 people split between approximately two shifts per day (5am to 1pm and 11am to 7pm).

### **Facilities**

Each of the uses above would require the construction of ancillary structures including but not limited to transloading/warehousing buildings, mechanical equipment and misc. industrial appurtenances, office areas, parking areas, landscaping and parking. The facility sizes are not known at this time but for the purposes of this analysis it assumes that buildings such as warehouses with air conditioning could be approximately 1,050,000 SF.

### **Project Utilities**

#### Water

The Proposed Project will receive raw water from IID via the Dahlia Lateral 8 and treat said raw water to potable standards for distribution to all Project elements which will procure their own respective quantities of water. The Project will also have its own dedicated raw water line for access to bulk process water from IID.

Over the last 10 years the Project site has consumed approximately 630 acre-feet (AF) of water per year on average in order for 120 acres of the Project site to be farmed. The proposed annual water usage, including operational water and drinking water for the Project site once fully developed would require 180 AF of water or a reduction for 450 AF of water per year. The Project will include septic systems with leach fields for the different elements of the logistics center in accordance with State and County standards. During initial operations and prior to the need for a public water system, the applicant may truck-in purified/potable water.

### Electrical

Electrical service will be from IID existing on-site distribution level voltage facilities near the cemetery, the existing IID on-site distribution level voltage facilities near the UPRR, IID existing distribution level voltage facilities south of the site along Harris Road, and/or self-generated with solar panels. If solar panels are used, they would be installed on the roofs of buildings and would interconnect by way of a bi-directional meter that would also serve as the metering element for power purchased from IID. The solar panels would be used solely for Project operations. The solar panels could utilize a battery energy storage element that would require approval from the County Planning Department, prior to installation. IID also has transmission level voltage facilities east of the site along the UPRR ROW, which can be tapped as needed for substation development.

### Natural Gas

Natural gas will come from the SoCal Gas existing pipeline system on Keystone Road. Under Existing conditions many commodities are currently transported via truck from the Ports of Los Angeles and Long Beach, through the Inland Empire and Palm Desert, to the Calexico East Port of Entry via SR 86 and SR 111, or otherwise to/from destinations/origins within Imperial County. Development of the Project site with loop tracks and ladder tracks that tie into the adjacent Union Pacific Railroad will accommodate in-bound and out-bound trains with commodities as well as transloading to and from trucks, thereby reducing the number of truck trips from Los Angeles and Long Beach. For example, a truckload of lumber or other commodities from Long Beach currently travels approximately 80-miles one-way within Imperial County. Post Project, the same lumber could be brought in via rail, and would only require an approximate 25-mile one-way trip by heavy vehicle to reach the same destination, thereby reducing the vehicle miles traveled by truck (LL&G, 2023).

### **Project Trip Generation and Truck Route Requirements**

Trip Generation for the Project would be 107 average daily trips (ADT) for employee passenger vehicles and as many 436 ADT for heavy duty trucks each day (218 physical trucks) (LL&G, 2023) as shown in Figure 1-C. As a Project feature, the Project will require inbound and outbound heavy trucks to adhere to the following designated truck routes. The designated truck routes are intended to restrict heavy vehicles from turning across multiple lanes of oncoming traffic at unsignalized intersections on SR 111. The truck route requirements will be included as a Condition of Approval and will be enforced through on-site signage, off-site signage as appropriate, and in contracts with outside trucking agencies.

**Figure 1-C: Project Trip Generation**

Number and Type of Trips	Daily Trips			AM Peak Hour (w/PCE)			PM Peak Hour (w/PCE) <sup>d</sup>		
	ADT <sup>a</sup>	PCE <sup>b</sup>	PCE Adjusted ADT	In	Out	Total	In	Out	Total
<b>Phase 1</b>									
20 Worker Vehicles <sup>c</sup>	42	1.0	42	4	0	4	0	4	4
48 Grain Elevator Trucks	96	2.0	192	7	7	14	7	7	14
24 Fuel trucks	48	2.0	96	3	3	6	3	3	6
8 Railed-in Products Export Trucks	16	2.0	32	1	1	2	1	1	2
20 Trucking Only Trucks	40	2.0	80	3	3	6	3	3	6
<b>Phase 1 Subtotal</b>	<b>242</b>	<b>-</b>	<b>442</b>	<b>18</b>	<b>14</b>	<b>32</b>	<b>14</b>	<b>18</b>	<b>32</b>
<b>Phase 2</b>									
31 Worker Vehicles <sup>c</sup>	65	1.0	65	7	0	7	0	7	7
5 Grain Elevator Trucks	10	2.0	20	1	1	2	1	1	2
9 Fuel trucks	18	2.0	36	1	1	2	1	1	2
33 Railed-in Products Export Trucks	66	2.0	132	5	5	10	5	5	10
71 Trucking Only Trucks	142	2.0	284	10	10	20	10	10	20
<b>Phase 2 Subtotal</b>	<b>301</b>	<b>-</b>	<b>537</b>	<b>24</b>	<b>17</b>	<b>41</b>	<b>17</b>	<b>24</b>	<b>41</b>
<b>Total Trips:</b>	<b>543</b>	<b>-</b>	<b>979</b>	<b>42</b>	<b>31</b>	<b>73</b>	<b>31</b>	<b>42</b>	<b>73</b>
<p><b>Footnotes:</b></p> <p>a. Average Daily Trips</p> <p>b. Passenger Car Equivalents. Based on the <i>Highway Capacity Manual</i>, a Passenger Car Equivalent (PCE) factor of 2.0 was applied to the Project's heavy-truck trips.</p> <p>c. A total of 56 on-site employees are expected each day at Project buildout. Based on data provided in the <i>Imperial County Transportation Commission Regional Active Transportation Plan</i>, February 2022, 9% of the on-site employees (5 people total) were assumed to carpool with other employees. A trip rate of 2.1 ADT per worker vehicle was assumed to account for the trips to and from the Project site as well as the occasional mid-workday errand. Based on the location of the site, the provision of on-site services, and the nature of the Project, mid-workday trips are expected to be very sporadic.</p> <p>d. Heavy-duty trucks are assumed to access the site consistently between the hours of 5AM and 7PM (approximately 16 heavy vehicles per hour for 14-hours at Project buildout).</p>									



- When leaving the site, heavy trucks heading to the south / east via SR 111 will be required to make a right-turn out of the site onto SR 86, a right-turn from SR 86 to Keystone Road, a right-turn from Keystone Road to Dogwood Road, a left-turn from Dogwood Road onto Worthington Road, and a right-turn at the signalized intersection of Worthington Road and SR 111.
- Inbound trucks coming from the south / east via SR 111 will be required to make a left-turn at the signalized intersection of Worthington Road and SR 111, a right-turn onto Dogwood Road from Worthington Road, a left-turn onto Harris Road from Dogwood Road, a right-turn onto SR 86 from Harris Road, and a right-turn into the site.

Under Existing conditions many commodities are currently transported via truck from the Ports of Los Angeles and Long Beach, through the Inland Empire and Palm Desert, to the Calexico East Port of Entry via SR 86 and SR 111, or otherwise to/from destinations/origins within Imperial County. Development of the Project site with loop tracks and ladder tracks that tie into the adjacent Union Pacific Railroad will accommodate in-bound and out-bound trains with commodities as well as transloading to and from trucks, thereby reducing the number of truck trips from Los Angeles and Long Beach.

For example, a truckload of lumber or other commodities from Long Beach currently travels approximately 80-miles one-way within Imperial County. Post Project, the same lumber could be brought in via rail, and would only require an approximate 25-mile one-way trip by heavy vehicle to reach the same destination, thereby reducing the vehicle miles traveled by 55 miles one-way by truck. For this reason, the Project would cumulatively reduce VMT for each trip produced by the Project and would therefore have a cumulative reduction on all air quality emissions from trucks. The air quality emissions from the reduced VMT of the trucks is not included in this Project even though the air quality emissions generated once the Project is operational would be less than what is currently being generated today. For this analysis the Air Quality emissions from the heavy trucks is zero.

### **Project Train Generation**

Upon review of the Project, up to 2.1 trains would be expected daily and would likely contain as many as 60 cars each. In addition, it is expected that up to two locomotives daily would be required per train accessing the new rail loop as part of the Green Valley Logistics Project.

## **2.0 EXISTING ENVIRONMENTAL SETTING**

### **2.1 Existing Setting**

The Project site contains existing agricultural operations, including approximately 120 acres of recently harvested wheat that is planted and harvested as a rotation crop between other crops. The Project has an existing mainline switch on the Union Pacific Railroad and approximately 0.5 mile of on-site track. The Project site has vacant areas that have previously been farmed and the existing Memory Gardens Cemetery. Over the last 10 years, the Project site has consumed approximately 630 acre-feet per year (AFY) of water for agricultural purposes.

Mesquite Lake Specific Plan is located north, east, and south of the Project site, with agricultural land uses and equipment dealerships and other businesses located west of the Project site. North of the site is vacant, disturbed land, followed by a sugar manufacturing facility. East of the site is the UPRR, followed by agricultural fields. South of the site are agricultural fields as well as a property with a CUP for the development of a fertilizer terminal. A mix of agricultural fields and manufacturing uses, including Bakersfield Pipe Supply, RDO Farm Equipment, Empire Construction Machine Rental, and Rain for Rent, are located west of the Project site. The nearest sensitive residential receptor is located approximately 0.25 mile east of the Project site.

### **2.2 Climate and Meteorology**

Climate within the SSAB experiences mild and dry winters with daytime temperatures ranging from 65 to 75 °F, extremely hot summers with daytime temperatures ranging from 104 to 115 °F, and very little rain. Imperial County usually receives approximately three inches of rain per year mostly occurring in late summer or midwinter. Summer weather patterns are dominated by intense heat induction low-pressure areas over the interior desert. The flat terrain of the Imperial Valley and the strong temperature differentials created by intense solar heating produce moderate winds and deep thermal convection.

The general wind speeds in the area are less than 10 mph, but occasionally experience winds speeds of greater than 30 mph during the months of April and May. Statistics reveal that prevailing winds blow from the northwest-northeast; a secondary trend of wind direction from the southeast is also evident.

## 2.3 Regulatory Standards

### 2.3.1 Federal Standards and Definitions

The Federal Air Quality Standards were developed per the requirements of The Federal Clean Air Act, which is a federal law that was passed in 1970 and further amended in 1990. This law provides the basis for the national air pollution control effort. An important element of the act included the development of national ambient air quality standards (NAAQS) for major air pollutants.

The Clean Air Act established two types of air quality standards otherwise known as primary and secondary standards. **Primary Standards** set limits for the intention of protecting public health, which includes sensitive populations such as asthmatics, children and elderly. **Secondary Standards** set limits to protect public welfare to include the protection against decreased visibility, damage to animals, crops, vegetation and buildings.

The EPA Office of Air Quality Planning and Standards (OAQPS) has set NAAQS for principal pollutants, which are called "criteria" pollutants. These pollutants are defined below:

1. **Carbon Monoxide (CO):** *is a colorless, odorless, and tasteless gas and is produced from the partial combustion of carbon-containing compounds, notably in internal-combustion engines. Carbon monoxide usually forms when there is a reduced availability of oxygen present during the combustion process. Exposure to CO near the levels of the ambient air quality standards can lead to fatigue, headaches, confusion, and dizziness. CO interferes with the blood's ability to carry oxygen.*
2. **Lead (Pb):** *is a potent neurotoxin that accumulates in soft tissues and bone over time. The major sources of lead emissions have historically been motor vehicles (such as cars and trucks) and industrial sources. Because lead is only slowly excreted, exposures to small amounts of lead from a variety of sources can accumulate to harmful levels. Effects from inhalation of lead near the level of the ambient air quality standard include impaired blood formation and nerve conduction. Lead can adversely affect the nervous, reproductive, digestive, immune, and blood-forming systems. Symptoms can include fatigue, anxiety, short-term memory loss, depression, weakness in the extremities, and learning disabilities in children.*
3. **Nitrogen Dioxide (NO<sub>2</sub>):** *is a reactive, oxidizing gas capable of damaging cells lining the respiratory tract and is one of the nitrogen oxides emitted from high-temperature combustion, such as those occurring in trucks, cars, power plants, home heaters, and gas stoves. In the presence of other air contaminants, NO<sub>2</sub> is usually visible as a reddish-brown air layer over urban areas. NO<sub>2</sub> along with other traffic-related pollutants is associated with respiratory symptoms, respiratory illness and respiratory impairment. Studies in animals have reported biochemical, structural, and cellular changes in the lung when exposed to NO<sub>2</sub> above the level of the current state air quality standard. Clinical studies of human subjects suggest that NO<sub>2</sub> exposure to levels near the current standard may worsen the effect of allergens in allergic asthmatics, especially in children.*
4. **Particulate Matter (PM<sub>10</sub> or PM<sub>2.5</sub>):** *is a complex mixture of tiny particles that consists of dry solid fragments, solid cores with liquid coatings, and small droplets of liquid. These particles vary in shape, size and chemical composition, and can be made up of multiple*

materials such as metal, soot, soil, and dust.  $PM_{10}$  particles are 10 microns ( $\mu m$ ) or less and  $PM_{2.5}$  particles are 2.5 ( $\mu m$ ) or less. These particles can contribute significantly to regional haze and reduction of visibility in California. Exposure to PM levels exceeding current air quality standards increases the risk of allergies such as asthma and respiratory illness.

5. **Ozone ( $O_3$ ):** is a highly oxidative unstable gas capable of damaging the linings of the respiratory tract. This pollutant forms in the atmosphere through reactions between chemicals directly emitted from vehicles, industrial plants, and many other sources. Exposure to ozone above ambient air quality standards can lead to human health effects such as lung inflammation, tissue damage and impaired lung functioning. Ozone can also damage materials such as rubber, fabrics and plastics.
6. **Sulfur Dioxide ( $SO_2$ ):** is a gaseous compound of sulfur and oxygen and is formed when sulfur-containing fuel is burned by mobile sources, such as locomotives, ships, and off-road diesel equipment.  $SO_2$  is also emitted from several industrial processes, such as petroleum refining and metal processing. Effects from  $SO_2$  exposures at levels near the one-hour standard include bronchoconstriction accompanied by symptoms, which may include wheezing, shortness of breath and chest tightness, especially during exercise or physical activity. Children, the elderly, and people with asthma, cardiovascular disease or chronic lung disease (such as bronchitis or emphysema) are most susceptible to these symptoms. Continued exposure at elevated levels of  $SO_2$  results in increased incidence of pulmonary symptoms and disease, decreased pulmonary function, and increased risk of mortality.

### 2.3.2 State Standards and Definitions

The State of California Air Resources Board (CARB) sets the laws and regulations for air quality on the state level. The California Ambient Air Quality Standards (CAAQS) are either the same as or more restrictive than the NAAQS with the exception of the 1-hr  $NO_2$  standards which are stricter under the NAAQS. The CAAQS also restricts four additional contaminants. Table 2.1 identifies both the NAAQS and CAAQS.

The additional contaminants as regulated by the CAAQS are defined below:

1. **Visibility Reducing Particles:** Particles in the Air that obstruct the visibility.
2. **Sulfates:** are salts of Sulfuric Acid. Sulfates occur as microscopic particles (aerosols) resulting from fossil fuel and biomass combustion. They increase the acidity of the atmosphere and form acid rain.
3. **Hydrogen Sulfide ( $H_2S$ ):** is a colorless, toxic and flammable gas with a recognizable smell of rotten eggs or flatulence.  $H_2S$  occurs naturally in crude petroleum, natural gas, volcanic gases, and hot springs. Usually,  $H_2S$  is formed from bacterial breakdown of organic matter. Exposure to low concentrations of hydrogen sulfide may cause irritation to the eyes, nose, or throat. It may also cause difficulty in breathing for some asthmatics. Brief exposures to high concentrations of hydrogen sulfide (greater than 500 Parts per Million (ppm)) can cause a loss of consciousness and possibly death.
4. **Vinyl Chloride:** also known as chloroethene and is a toxic, carcinogenic, colorless gas with a sweet odor. It is an industrial chemical mainly used to produce its polymer, polyvinyl chloride (PVC).



**Table 2.1: Ambient Air Quality Standards**

Ambient Air Quality Standards						
Pollutant	Average Time	California Standards <sup>1</sup>		Federal Standards <sup>2</sup>		
		Concentration <sup>3</sup>	Method <sup>4</sup>	Primary <sup>3,5</sup>	Secondary <sup>3,6</sup>	Method <sup>7</sup>
Ozone (O <sub>3</sub> ) <sup>9</sup>	1 Hour	0.09 ppm (180 µg/m <sup>3</sup> )	Ultraviolet Photometry	-	Same as Primary Standard	Ultraviolet Photometry
	8 Hour	0.070 ppm (137 µg/m <sup>3</sup> )		0.070 ppm (137 µg/m <sup>3</sup> )		
Respirable Particulate Matter (PM10) <sup>9</sup>	24 Hour	50 µg/m <sup>3</sup>	Gravimetric or Beta Attenuation	150 µg/m <sup>3</sup>	Same as Primary Standard	Inertial Separation and Gravimetric Analysis
	Annual Arithmetic Mean	20 µg/m <sup>3</sup>		-		
Fine Particulate Matter (PM2.5) <sup>9</sup>	24 Hour	No Separate State Standard		35 µg/m <sup>3</sup>	Same as Primary Standard	Inertial Separation and Gravimetric Analysis
	Annual Arithmetic Mean	12 µg/m <sup>3</sup>	Gravimetric or Beta Attenuation	12.0 µg/m <sup>3</sup>		
Carbon Monoxide (CO)	8 hour	9.0 ppm (10 mg/m <sup>3</sup> )	Non-Dispersive Infrared Photometry (NDIR)	9 ppm (10 mg/m <sup>3</sup> )	-	Non-Dispersive Infrared Photometry
	1 hour	20 ppm (23 mg/m <sup>3</sup> )		35 ppm (40 mg/m <sup>3</sup> )		
	8 Hour (Lake Tahoe)	6 ppm (7 mg/m <sup>3</sup> )		-		
Nitrogen Dioxide (NO <sub>2</sub> ) <sup>10</sup>	Annual Arithmetic Mean	0.030 ppm (57 µg/m <sup>3</sup> )	Gas Phase Chemiluminescence	0.053 ppm (100 µg/m <sup>3</sup> ) <sup>8</sup>	Same as Primary Standard	Gas Phase Chemiluminescence
	1 Hour	0.18 ppm (339 µg/m <sup>3</sup> )		0.100 ppm <sup>9</sup> (188 µg/m <sup>3</sup> )		
Sulfur Dioxide (SO <sub>2</sub> ) <sup>11</sup>	Annual Arithmetic Mean	-	Ultraviolet Fluorescence	0.030 ppm <sup>10</sup> (for Certain Areas)	-	Ultraviolet Fluorescence; Spectrophotometry (Pararosaniline Method) <sup>9</sup>
	24 Hour	0.04 ppm (105 µg/m <sup>3</sup> )		0.14 ppm <sup>10</sup> (for Certain Areas) (See Footnote 9)		
	3 Hour	-		-		
	1 Hour	0.25 ppm (655 µg/m <sup>3</sup> )		75 ppb (196 µg/m <sup>3</sup> )		
Lead <sup>12,13</sup>	30 Day Average	1.5 µg/m <sup>3</sup>	Atomic Absorption	-	Same as Primary Standard	High Volume Sampler and Atomic Absorption
	Calendar Quarter	-		1.5 µg/m <sup>3</sup>		
	Rolling 3-Month Average	-		0.15 µg/m <sup>3</sup>		
Visibility Reducing Particles	8 Hour	See footnote 14				
Sulfates	24 Hour	25 µg/m <sup>3</sup>	Ion Chromatography			
Hydrogen Sulfide	1 Hour	0.03 ppm (42 µg/m <sup>3</sup> )	Ultraviolet Fluorescence			
Vinyl Chloride <sup>12</sup>	24 Hour	0.01 ppm (26 µg/m <sup>3</sup> )	Gas Chromatography			

1. California standards for ozone, carbon monoxide (except 8-hour Lake Tahoe), sulfur dioxide (1 and 24 hour), nitrogen dioxide, and particulate matter (PM10, PM2.5, and visibility reducing particles), are values that are not to be exceeded. All others are not to be equaled or exceeded. California ambient air quality standards are listed in the Table of Standards in Section 70200 of Title 17 of the California Code of Regulations.
2. National standards (other than ozone, particulate matter, and those based on annual arithmetic mean) are not to be exceeded more than once a year. The ozone standard is attained when the fourth highest 8-hour concentration measured at each site in a year, averaged over three years, is equal to or less than the standard. For PM10, the 24-hour standard is attained when the expected number of days per calendar year with a 24-hour average concentration above 150 µg/m<sup>3</sup> is equal to or less than one. For PM2.5, the 24-hour standard is attained when 98 percent of the daily concentrations, averaged over three years, are equal to or less than the standard. Contact the U.S. EPA for further clarification and current national policies.
3. Concentration expressed first in units in which it was promulgated. Equivalent units given in parentheses are based upon a reference temperature of 25°C and a reference pressure of 760 torr. Most measurements of air quality are to be corrected to a reference temperature of 25°C and a reference pressure of 760 torr; ppm in this table refers to ppm by volume, or micromoles of pollutant per mole of gas.
4. Any equivalent procedure which can be shown to the satisfaction CARB to give equivalent results at or near the level of the air quality standard may be used.
5. National Primary Standards: The levels of air quality necessary, with an adequate margin of safety to protect the public health.
6. National Secondary Standards: The levels of air quality necessary to protect the public welfare from any known or anticipated adverse effects of a pollutant.
7. Reference method as described by the EPA. An "equivalent method" of measurement may be used but must have a "consistent relationship to the reference method" and must be approved by the EPA.
8. On October 1, 2015, the national 8-hour ozone primary and secondary standards were lowered from 0.075 to 0.070 ppm.
9. On December 14, 2012, the national annual PM2.5 primary standard was lowered from 15 µg/m<sup>3</sup> to 12.0 µg/m<sup>3</sup>. The existing national 24-hour PM2.5 standards (primary and secondary) were retained at 35 µg/m<sup>3</sup>, as was the annual secondary standard of 15 µg/m<sup>3</sup>. The existing 24-hour PM10 standards (primary and secondary) of 150 µg/m<sup>3</sup> also were retained. The form of the annual primary and secondary standards is the annual mean, averaged over 3 years.
10. To attain the 1-hour national standard, the 3-year average of the annual 98th percentile of the 1-hour daily maximum concentrations at each site must not exceed 100 ppb. Note that the national 1-hour standard is in units of parts per billion (ppb). California standards are in units of parts per million (ppm). To directly compare the national 1-hour standard to the California standards the units can be converted from ppb to ppm. In this case, the national standard of 100 ppb is identical to 0.100 ppm.
11. On June 2, 2010, a new 1-hour SO<sub>2</sub> standard was established and the existing 24-hour and annual primary standards were revoked. To attain the 1-hour national standard, the 3-year average of the annual 99th percentile of the 1-hour daily maximum concentrations at each site must not exceed 75 ppb. The 1971 SO<sub>2</sub> national standards (24-hour and annual) remain in effect until one year after an area is designated for the 2010 standard, except that in areas designated nonattainment for the 1971 standards, the 1971 standards remain in effect until implementation plans to attain or maintain the 2010 standards are approved.
12. The CARB has identified lead and vinyl chloride as 'toxic air contaminants' with no threshold level of exposure for adverse health effects determined. These actions allow for the implementation of control measures at levels below the ambient concentrations specified for these pollutants.
13. The national standard for lead was revised on October 15, 2008 to a rolling 3-month average. The 1978 lead standard (1.5 µg/m<sup>3</sup> as a quarterly average) remains in effect until one year after an area is designated for the 2008 standard, except that in areas designated nonattainment for the 1978 standard, the 1978 standard remains in effect until implementation plans to attain or maintain the 2008 standard are approved.
14. In 1989, the CARB converted both the general statewide 10-mile visibility standard and the Lake Tahoe 30-mile visibility standard to instrumental equivalents, which are "extinction of 0.23 per kilometer" and "extinction of 0.07 per kilometer" for the statewide and Lake Tahoe Air Basin standards, respectively.

Source: (California Air Resources Board, 5/4/2016)



### 2.3.3 Regional Standards

The State of California has 35 specific air districts, which are each responsible for ensuring that the criteria pollutants are below the NAAQS and CAAQS. Air basins that exceed either the NAAQS or the CAAQS for any criteria pollutants are designated as “non-attainment areas” for that pollutant. Currently, there are 15 non-attainment areas for the federal ozone standard and two non-attainment areas for the PM2.5 standard and many areas are in non-attainment for PM10 as well. California therefore created the California State Implementation Plan (SIP), which is designed to provide control measures needed to attain ambient air quality standards.

The Imperial County Air Pollution Control District (ICAPCD) is the government agency which regulates stationary sources of air pollution within Imperial County and the SSAB. Currently, the SSAB is in “non-attainment” status for O<sub>3</sub> and serious non-attainment of PM10. Therefore, the ICAPCD developed an Ambient Air Quality Plan (AAQP) to provide control measures to try to achieve attainment status. The AAQP was adopted in 1991. A new NAAQS for ozone was adopted by EPA in 1997 and required modified strategies to decrease higher ozone concentrations.

In order to guide non-attainment areas closer to NAAQS requirements an 8-hr Ozone Air Quality Management Plan (AQMP) was approved by ICAPCD in 2009 and was accepted by the EPA in 2010. Similarly, in 2009 the County revised their SIP to address the serious non-attainment status of PM<sub>10</sub> and again revised the plan in 2013, 2017 and 2018 (ICAPCD, 2018). The criteria pollutant standards are generally attained when each monitor within the region that has had no exceedances during the previous three calendar years. Attainment status within the County of Imperial as of the date of this report is shown in Table 2.2.

**Table 2.2: Imperial County Air Basin Attainment Status by Pollutant**

Criteria Pollutant	Federal Designation	State Designation
Ozone	Marginal Nonattainment	Nonattainment
Carbon Monoxide	Unclassified/ Attainment	Attainment
PM10	Serious Nonattainment	Nonattainment
PM2.5	Moderate Nonattainment – partial*	Attainment
Nitrogen Dioxide	Unclassified/ Attainment	Attainment
Sulfur Dioxide	Attainment	Attainment
Lead	Unclassified/ Attainment	Attainment
Sulfates	No Federal Standard	Attainment
Hydrogen Sulfide	No Federal Standard	Unclassified
Visibility	No Federal Standard	Unclassified

## 2.4 California Environmental Quality Act (CEQA) Significance Thresholds

CEQA has provided a checklist to identify the significance of air quality impacts. These guidelines are found in Appendix G of the CEQA guidelines and are as follows:

AIR QUALITY -- Where available, the significance criteria established by the applicable air quality management or air pollution control district may be relied upon to make the following determinations. Would the Project:

- A:* Conflict with or obstruct implementation of the applicable air quality plan?
- B:* Result in a cumulatively considerable net increase of any criteria pollutant for which the project region is non-attainment under an applicable federal or state ambient air quality standard?
- C:* Expose sensitive receptors to substantial pollutant concentrations?
- D:* Result in other emissions (such as those leading to odors adversely affecting a substantial number of people?

## 2.5 ICAPCD Air Quality Impact Assessment Screening Thresholds (CEQA)

The ICAPCD has established significance thresholds in the 2017 ICAPCD CEQA Handbook for the preparation of Air Quality Impact Assessments (AQIA) (ICAPCD, 2017). The screening criteria within this handbook can be used to determine whether a project's total emissions would result in a significant impact as defined by CEQA. Should emissions be found to exceed these thresholds, additional modeling is required to demonstrate that the project's total air quality impacts are below the state and federal ambient air quality standards. These screening thresholds for construction and daily operations are shown in Table 2.3.

The CEQA handbook further states that any proposed project with a potential to emit less than the Tier I thresholds during operations may potentially still have adverse impacts on the local air quality and would be required to develop an Initial Study to help the Lead Agency determine whether the project would have a less than significant impact.

On the other hand, if the proposed project's operational development fits within the Tier II classification, it is considered to have a significant impact on regional and local air quality. Therefore, Tier II projects are required to implement all standard mitigation measures as well as all feasible discretionary mitigation measures. Additionally, ICAPCD defined standard mitigation measures for construction equipment and fugitive PM10 must be implemented at all construction sites. The implementation of mitigation measures, as listed in the ICAPCD CEQA handbook, apply to those construction sites which are 5 acres or more for non-residential developments such as the proposed Project.

**Table 2.3: Screening Threshold for Criteria Pollutants**

Pollutant	Total Emissions (Pounds per Day)	
<b>Construction Emissions</b>		
Respirable Particulate Matter (PM <sub>10</sub> and PM <sub>2.5</sub> )	150	
Nitrogen Oxide (NO <sub>x</sub> )	100	
Carbon Monoxide (CO)	550	
Reactive Organic Gases (ROG)	75	
<b>Operational Emissions</b>		
Pollutant	Tier I (Pounds per Day)	Tier II (Pounds per Day)
PM <sub>10</sub> and Sulfur Oxide (SO <sub>x</sub> )	< 150	150 or greater
NO <sub>x</sub> and ROG	< 137	137 or greater
CO	< 550	550 or greater
Level of Significance:	Less Than Significant	Significant Impact
Level of Analysis:	Initial Study	Comprehensive Air Quality Analysis Report
Environmental Document:	Negative Declaration	Mitigated ND or EIR
Source: (ICAPCD, 2017)		

In an effort to reduce PM<sub>10</sub> or Fugitive Dust from ambient air, the Project would be required to develop a dust management plan consistent with Regulation VIII of ICAPCD's Rules and Regulations. Additionally, the project shall not exceed the 20 percent opacity threshold under Rule 801.

*Standard Construction Site Design Measures:*

1. *Use of alternative fueled or catalyst equipped diesel construction equipment, including all off-road and portable diesel powered equipment.*
2. *Minimize idling time either by shutting equipment off when not in use or reducing the time of idling to 5 minutes as a maximum.*
3. *Limit, to the extent feasible, the hours of operation of heavy duty equipment and/or the amount of equipment in use.*
4. *Replace fossil fueled equipment with electrically driven equivalents (provided they are not run via a portable generator set).*

Should the project be sufficiently large enough that operational mitigation measures simply cannot reduce pollutant levels below thresholds of significance, pollutant levels the ICAPCD has adopted the Operation Development Fee as was adopted under Rule 310 which provides the ICAPCD with a sound method for mitigating the emissions produced from the operation of new commercial and residential development projects. Projects unmitigable through standard procedures are assessed a one-time fee for either Ozone Precursors or

PM<sub>10</sub> impacts, which is based upon either the square footage of the commercial development or the number of residential units. Impacts of this sort are calculated based on the assumption that the worst-case daily emissions are allowed for an entire year and then converted to an annual emission equivalent. Emissions exceeding annual thresholds would pay a fair share sum to reduce impacts to below significance.

Similar to construction, the project would be required to implement standard mitigation measures for operations. According to Table 2.3, Tier I, projects generating less than 137 lbs/day of NO<sub>x</sub> or ROG; less than 150 lbs/day of PM<sub>10</sub> or SO<sub>x</sub>; or less than 550 lbs/day of CO or PM<sub>2.5</sub>, the Project is required to implement all the Standard Operational Mitigation Measures in order to help mitigate or reduce the air quality impacts to a level of insignificance. These mitigation measures are identified below:

*Standard Operations Site Design Measures:*

- 1. Provide on-site bicycle lockers and/or racks.*
- 2. Provide on-site eating, refrigeration and food vending facilities to reduce lunchtime trips.*
- 3. Provide shower and locker facilities to encourage employees to bike and/or walk to work.*
- 4. Provide for paving a minimum of 100 feet from the property line for commercial driveways that access County paved roads as per County Standard Commercial Driveway Detail 410B (formerly SW-131A). It should be noted that the project would also pave McDonald Road from HWY 111 to English Road.*
- 5. Measures which meet mandatory, prescriptive and/or performance measures as required by Title 24.*

Furthermore, consistent with the California Air Resource Board, ICAPCD requires PM<sub>10</sub> emitted by diesel powered construction equipment (DPM) to be analyzed. DPM can potentially increase the cancer risk for nearby residential receptors if any. Generally, sites increasing the cancer risk between one and ten in one million need to implement toxics best available control technology or impose effective emission limitations, emission control devices or control techniques to reduce the cancer risk. Finally, at no time shall the project increase the cancer risk to over 10 in one million.

## 2.6 Local Air Quality

Criteria pollutants are measured continuously throughout the County of Imperial and the data is used to track ambient air quality patterns throughout the County. As mentioned earlier, this data is also used to determine attainment status when compared to the NAAQS and CAAQS. The ICAPCD is responsible for monitoring four sites which collect meteorological and criteria pollutant data used by the district to assist with pollutant

forecasting, data analysis and characterization of air pollutant transport. Also, a fifth monitoring locations is located in the City of Calexico which is monitored by CARB.

The monitoring stations surrounding the project provide various pieces of data but no single station has all the data. Table 2.4 provides the criteria pollutant levels monitored within the Basin for 2017-2019. The criteria pollutants monitored closest to the Project [Ambient data was obtained from the California Environmental Protection Agency’s Air Resources Board Website (ARB, 2023)]. Based on review of the ambient data, Both Ozone and PM emissions exceed AAQS and therefore are in non-attainment status. The 8 hour Ozone non-Attainment is considered moderate Non-Attainment while the 24-Hour PM10 is considered “Serious” Non-Attainment. Therefore, to comply with the ICAPCDs SIP and AAQP, the project must implement Best Available Control Measure (BACM) and BACT as outlined in the standard mitigation measures that all projects must implement in Section 2.5.

**Table 2.4: Three-Year Ambient Air Quality data**

Pollutant	Averaging Time	CAAQS	NAAQS	2019	2020	2021
O <sub>3</sub> (ppm)	1 Hour	0.09 ppm	No Standard	0.106	0.119	0.122
	8 Hour	0.070 ppm	0.070 ppm	0.089	0.094	0.094
PM <sub>10</sub> (µg/m <sup>3</sup> )	24 Hour	50 µg/m <sup>3</sup>	150 µg/m <sup>3</sup>	324.4	680.6	547.1
	Annual Arithmetic Mean	20 µg/m <sup>3</sup>	No Standard	44.5	54.4	52.1
PM <sub>2.5</sub> (µg/m <sup>3</sup> )	24 Hour	No standard	35 µg/m <sup>3</sup>	53.1	47.4	60.8
	Annual Arithmetic Mean	12 µg/m <sup>3</sup>	15 µg/m <sup>3</sup>	9.5	11.6	10.3
NO <sub>2</sub> (ppm)	Annual Arithmetic Mean	0.030 ppm	0.053 ppm	0.009	0.010	0.010
	1 Hour	0.18 ppm	0.100 ppm	0.096	0.076	0.096
ppm=Parts per Million N/A=Not Available for give year						



### **3.0 METHODOLOGY**

#### 3.1 Construction Emissions Calculations

##### CalEEMod

Air Quality impacts related to construction and daily operations were calculated using the latest CalEEMod 2020.4.0 air quality model, which was developed by BREEZE Software for South Coast Air Quality Management District (SCAQMD) in 2017. The construction module in CalEEMod is used to calculate the emissions associated with the construction of the Project and uses methodologies presented in the US EPA AP-42 document with emphasis on Chapter 11.9. The CalEEMod input/output model is shown in **Attachment A** to this report. Also, since PM10 mitigation is required as you will see later in this report. The mitigated CalEEMod input/output is also provided in **Attachment B** to this report.

It should be noted that default settings for CalEEMod include an assumption for roads within imperial county to be only 50% paved. The County has been improving many of these roads to paved sections. As noted in construction design measures 2-4 above, the project would implement design features which would require all construction workers, vendors and hauling to only used paved or improved roads to minimize dust. Based on this, a 100% paved scenario would be expected but for modeling purposes a 90% paved scenario was assumed. The project would also install wheel shakers leaving the project site to minimize dust from leaving the project site onto the roadways.

##### AERMOD

The AERMOD dispersion model was used to determine the concentration for air pollutants at sensitive receptors near the Project. Additionally, the model will predict the maximum exposure distance and concentrations. The notable toxic air contaminant from construction is diesel exhaust since exposure to diesel exhaust is known to cause cancer and acute and chronic health effects. Diesel exhaust emissions can be estimated using the annual PM<sub>10</sub> exhaust emissions from onsite construction operations obtained from the annual CalEEMod model output by summing each onsite source for the construction duration. The AERMOD input/output file for the proposed Project construction activities is shown in **Attachment C** at the end of this report. It should be noted that the Project would have a design feature to use at least Tier 3 construction equipment.

##### Health Risks

Once the dispersed concentrations of diesel particulates are estimated in the surrounding air, they are used to evaluate estimated exposure to people. Exposure is evaluated by

calculating the dose in milligrams per kilogram body weight per day (mg/kg/d). For exposure, the breathing rates are determined for specific age groups, so inhalation dose (Dose-air) is calculated for each of these age groups, 3rd trimester, 0<2, 2<9, 2<16, 16<30 and 16-70 years. The following calculates this dose for exposure through the inhalation pathways and the worst case cancer risk dose calculation is defined in Equation 1 (OEHHA, February 2015):

*Equation 1*  $Dose_{air} = C_{air} * (BR/BW) * A * EF * (1 \times 10^{-6})$

- Dose<sub>air</sub> = Dose through inhalation (mg/kg/d)
- C<sub>air</sub> = Concentration in air (µg/m<sup>3</sup>) Annual average DPM concentration in µg/m<sup>3</sup>
- BR/BW = Daily breathing rate normalized to body weight (L/kg BW-day). See Table I.2 for the daily breathing rate for each age range.
- A = Inhalation absorption factor (assumed to be 1)
- EF = Exposure frequency (unitless, days/365 days)
- 1x10<sup>-6</sup> = Milligrams to micrograms conversion (10<sup>-3</sup> mg/ µg), cubic meters to liters conversion (10<sup>-3</sup> m<sup>3</sup>/l)

Cancer risk is calculated by multiplying the daily inhalation or oral dose, by a cancer potency factor, the age sensitivity factor, the frequency of time spent at home and the exposure duration divided by averaging time, to yield the excess cancer risk. As described below, the excess cancer risk is calculated separately for each age grouping and then summed to yield cancer risk for any given location. Specific factors as modeled are shown within the project models attached to this report. The worst case cancer risk calculation is defined in Equation 2 (OEHHA, 2015):

*Equation 2*  $RISK_{inh-res} = DOSE_{air} \times CPF \times ASF \times ED/AT \times FAH$

- RISK<sub>inh-res</sub> = Residential inhalation cancer risk
- DOSE<sub>air</sub> = Daily inhalation dose (mg/kg-day)
- CPF = Inhalation cancer potency factor (mg/kg-day<sup>-1</sup>)
- ASF = Age sensitivity factor for a specified age group (unitless)
- ED = Exposure duration (in years) for a specified age group
- AT = Averaging time for lifetime cancer risk (years)
- FAH = Fraction of time spent at home (unitless)

The California Office of Environmental Health Hazard Assessment (OEHHA) recommends that an exposure duration (residency time) of 30 years be used to estimate individual cancer risk for the Maximally Exposed Individual Resident (MEIR). OEHHA also recommends that the 30-year exposure duration be used as the basis for public notification and risk reduction audits and plans. Exposure durations of 9-years and 70-years are also recommended to be evaluated for the MEIR to show the range of cancer risk based on residency periods. If a facility is notifying the public regarding cancer risk, the 9-and 70-year cancer risk estimates

are useful for people who have resided in their current residence for periods shorter and longer than 30 years. Health risk calculations for construction are shown in **Attachment D** to this report.

A graphical representation of the modeling locations is shown on a site aerial below in Figure 3-A. The red points represent the sensitive residential receptors near the project. The Approximate distances are shown from the Project to the Project construction boundary. This location was selected and AERMOD will calculate the air quality emission concentrations.

Non-Cancer risks or risks defined as chronic or acute are also known with respect to DPM and are determined by the hazard index. To calculate hazard index, DPM concentration is divided by its chronic Reference Exposure Levels (REL). Where the total equals or exceeds one, a health hazard is presumed to exist. RELs are published by the Office of Environmental Health Hazard Assessment (OEHHA, 2015). Diesel Exhaust has a REL of 5  $\mu\text{g}/\text{m}^3$  and targets the respiratory system.

**Figure 3-A: Construction Health Risk Model Setup**

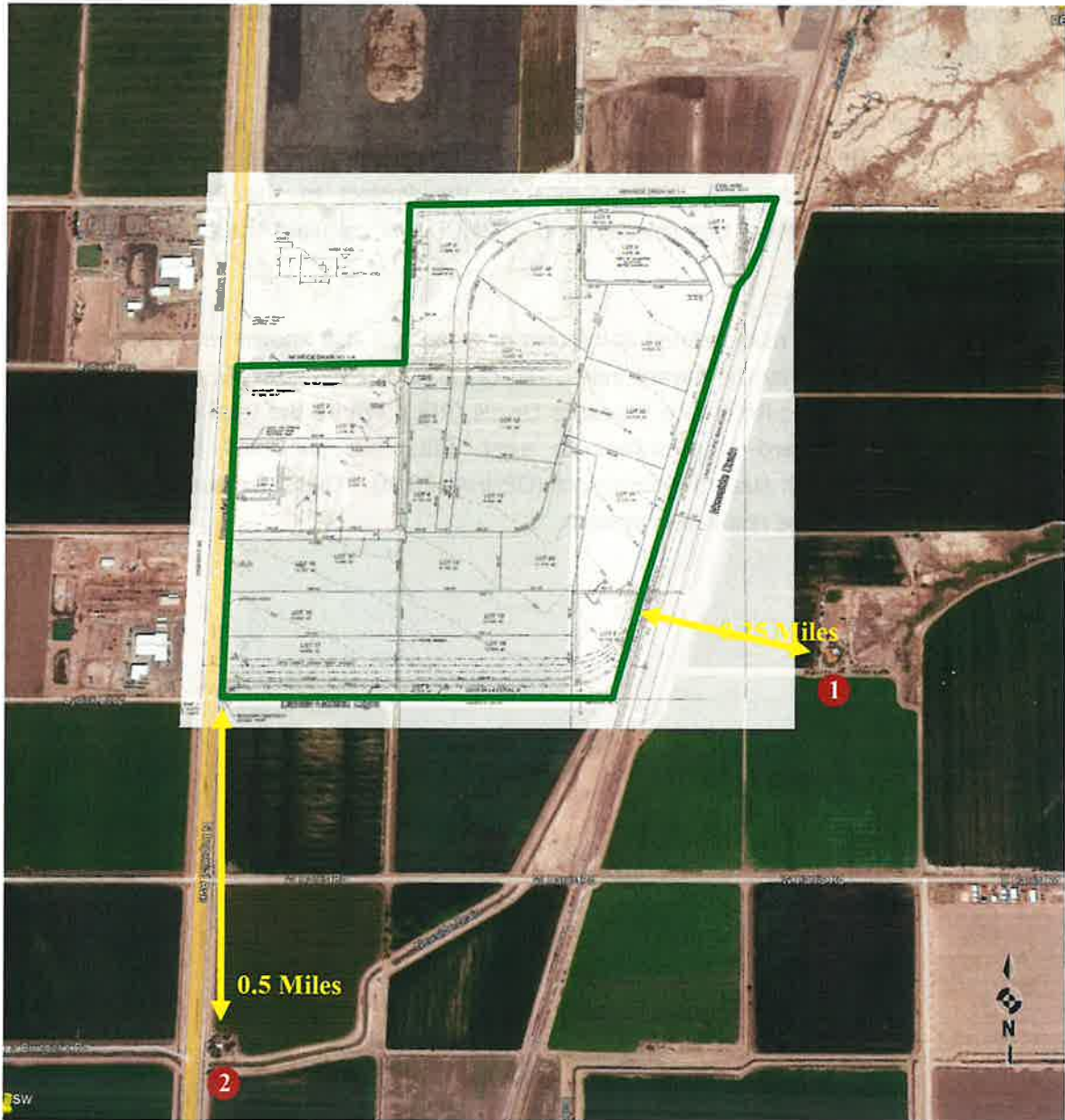

### 3.2 Construction Assumptions

Construction of the Project is expected to begin sometime in 2024 and would continue for approximately 18 months if the site is built-out under a single construction effort. Site preparation is anticipated to take approximately 2 months, grading to take approximately 2 months, and vertical construction to occur over approximately 14 months. Project build-out is expected in 2026. It should be noted depending on market demands, the Project construction may occur incrementally over time though analysis under a single effort is considered worst case.

Site preparation will include clearing and grubbing which would require export to a local recycling area. The land development includes grading to create rough graded streets, native soil preparatory work for track facilities, and pads for new construction. The site preparation will include an estimated 150,000 cubic yards (CY) of cut and 150,000 CY of fill; soil will be balanced on site.

The Project would require material imports which would include 140,000 CY of granular select fill for use underneath concrete building pads, an import of approximately 315,000 tons of ballast or 410,000 CY of material to construct the Project tracks and 28,000 tons or 32,000 CY of road base for the Industrial Street roadway, which will be surface finished with asphalt concrete. In all, the Project would import 582,000 CY of material and export roughly 1,000 CY of grubbed material.

A concrete and rebar bridge/over-pass or a culvert/under-pass may ultimately be built in order to take trucks to and from the inside of the loop tracks. Prior to the full loop tracks being constructed, a private roadway will be constructed for access to the central part of the Project.

It should be noted that this analysis assumes a construction of 1,050,000 SF of warehouse space. This space was assumed to be constructed over a short duration and would not be expected. Instead, the Project would construct these facilities over years.

Table 3.1 on the following page shows the expected timeframes and construction equipment necessary to fully construct all the project infrastructure, structures and rail lines. Additionally, the project would implement a number of design features which are identified on the following page. These design features were assumed within all modeling and therefore would be required and considered a condition to this Project's approval.



**Table 3.1: Expected Construction Equipment**

Equipment Identification	Proposed Start	Proposed Complete	Quantity
<b>Site Preparation</b>	1/1/2024	3/1/2024	
Rubber Tired Dozers			3
Tractors/Loaders/Backhoes			4
<b>Grading</b>	2/1/2024	4/3/2024	
Excavators			2
Graders			1
Rubber Tired Dozers			1
Scrapers			2
Tractors/Loaders/Backhoes			2
<b>Building Construction</b>	4/4/2024	6/30/2025	
Aerial Lifts			2
Cranes			2
Rough Terrain Forklifts			2
Tractors/Loaders/Backhoes			3
Welders			1
<b>Paving</b>	4/4/2024	5/8/2024	
Pavers			2
Paving Equipment			2
Rollers			2
<b>Architectural Coating</b>	7/1/2024	5/9/2025	

The PDFs included for construction were included in the CalEEMod modeling. The list is as follows:

1. Diesel equipment required which does not satisfy SDM 1 in Section 2.3 above shall be rated Tier 3 per EPA requirements. All modeling assumes the use of this equipment and is therefore a condition of the project.
2. All construction workers, vendors and haul trucks will be required to utilize paved roadways.
3. Operational On-Road trips shall not operate on unpaved dirt roads.
4. During construction of the project, the project would be required to maintain daily dust suppression using a water truck operating continuously while off road vehicles are driving on the Project site.
5. The project will provide wheel shakers at the exit of the construction site to minimize dust being tracked off the project site and onto the roadways.

### 3.3 Operational Emissions

Routine operations and maintenance of the facility will include preventative maintenance and repairs of any damaged or otherwise inoperable equipment on an as-needed basis. The operation and maintenance staff will monitor the facility operations over the Project life to ensure that the logistics center is operating to meet design standards. Approximately 56 full-time employees are expected each day of the week during Project operations to cover the below shown elements of the Project, with approximately 2 shifts per day (5am to 1pm and 11am to 7pm). The below shown Project elements will be developed in accordance with Mesquite Lake Specific Plan and County development standards.

Based on the projected traffic volumes estimated by the Project Traffic Engineer, the proposed project would generate approximately 107 regular employee ADT and as many as 436 ADT from heavy trucks. As noted by the Project traffic engineer, the Green Valley Logistics Project would reduce regional vehicle miles travelled since the Logistics Center essentially would allow for train containers to bulk transfer goods between the Los Angeles Area to Imperial County which are currently being carried via trucks mostly. The regional truck mileage associated with the Project site would essentially drop regional trips by more than a factor of 2/3 or 25miles vs 80 miles previously. Since each truck using the Green Valley Logistics center would reduce miles traveled within the County of Imperial, only the employee trips were modeled within CalEEMod.

As was noted earlier within the construction methodology section, CalEEMod includes an assumption for roads within imperial county to be only 50% paved. Project trips would only be on paved road sections or a 100% paved scenario in CalEEMod. To be conservative however, this analysis assumes a 90% paved roadway condition in the modeled inputs.

Operational air quality emission sources would also include area sources such as landscaping, consumer products and architectural coatings during maintenance, energy sources from electrical usage, solid waste from trash generation, and water uses, which are calculated within CalEEMod.

The Project area is currently being used for agricultural purposes and as noted in Section 1.3 of this report uses 630 acre-feet of water each year. The Project would reduce water consumption by 450 acre-feet per year and would use 180 acre-feet annually at buildout. CalEEMod assumes 180 acre-feet of water usage annually by the project and no credit for the 450 acre-feet was taken in this analysis.

### 3.4 Train Activities

The primary use of the site would enable goods to be shipped from the Los Angeles area into the County of Imperial in bulk via trains as opposed to via trucks which are currently being used. This effort would require as many as 2 trains daily. Each train was assumed to have two locomotives each and would have as many as 60 rail cars on each train.

Emission rates vary for each locomotive and locomotive technology is continuously improving. The Environmental Protection Agency (EPA) has established emission standards for oxides of nitrogen (NO<sub>x</sub>), hydrocarbons (HC), carbon monoxide (CO), particulate matter (PM) and smoke for newly manufactured and remanufactured locomotives. These standards, which are codified at 40 CFR part 1033, include several sets of emission standards with applicability dependent on the date a locomotive is first manufactured. The first set of standards (Tier 0) applies to most locomotives originally manufactured before 2001. The most stringent set of standards (Tier 4) applies to locomotives originally manufactured in 2015 and later (EPA, 2009). These standards are shown in Table 3.2 below. Using this data and the weighted averaging approach considering the fleet population breakdown as shown in Figure 3-B, the average PM<sub>10</sub>, NO<sub>x</sub> and CO emission factor can be calculated. for locomotive exhaust would be 0.168 g/bhp-hr.

**Table 3.2: Line-haul Emission Factors (g/bhp-hr)**

Locomotive Population by Tier	2020 Locomotive Breakdown Percentage	PM10 Allowable Rate	Weighted Average PM10 (g/bhp-hr)	NO <sub>x</sub> Allowable Rate	Weighted Average NO <sub>x</sub> (g/bhp-hr)	CO Allowable Rate	Weighted Total CO (g/bhp-hr)
Pre-Tier	3.1	0.32	0.00992	13	0.403	1.28	0.03968
Tier 0	11	0.32	0.0352	8.6	0.946	1.28	0.1408
Tier 0+	9.8	0.2	0.0196	7.2	0.7056	1.28	0.12544
Tier 1	0.8	0.32	0.00256	6.7	0.0536	1.28	0.01024
Tier 1+	29.3	0.2	0.0586	6.7	1.9631	1.28	0.37504
Tier 2	8.8	0.18	0.01584	4.95	0.4356	1.28	0.11264
Tier 2+	16.9	0.08	0.01352	4.95	0.83655	1.28	0.21632
Tier 3	15.5	0.08	0.0124	4.95	0.76725	1.28	0.1984
Tier 4	4.8	0.02	0.00096	1	0.048	1.28	0.06144
<b>Total</b>	<b>100</b>		<b>0.1686</b>		<b>6.1587</b>		<b>1.28</b>

**Figure 3-B: 2020 California Locomotive Population by Tier**

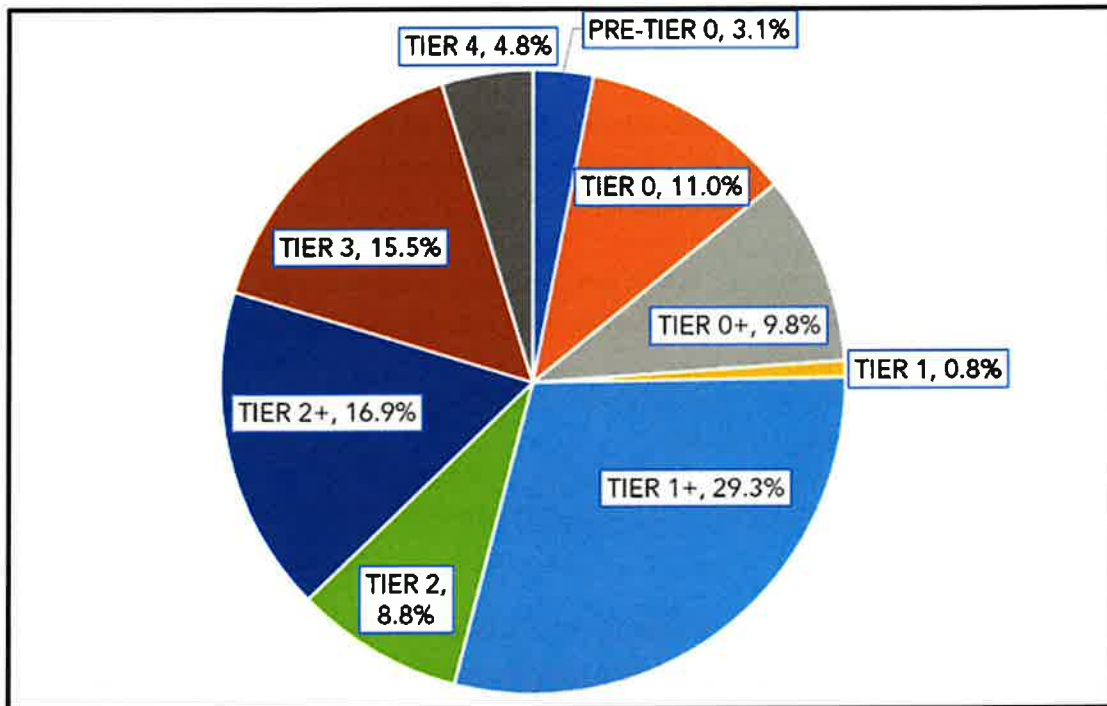

Source: (ARB, 2023)

### 3.5 Odor Impacts (Onsite)

Projects that involve offensive odors may be a nuisance to neighboring uses, including businesses, residences, sensitive receptors, and public areas. Odor impacts are most often the result of industrial type projects, livestock or farming operations, or can even be from restaurant or commercial baking operations. If a project has a potential to expose a substantial number of sensitive receptors to objectionable odors the project could be deemed to have a significant odor impact. The proposed project is located over 0.25 mile from a single sensitive receptor. Based on this, no significant objectionable odors would be expected from the operation.

## **4.0 FINDINGS**

### 4.1 Construction Findings

Construction emissions in pounds per day from the construction operations and equipment identified in Section 3.2 above is shown in Table 4.1 below. The project construction model includes project design features listed below:

1. Diesel equipment required which does not satisfy SDM 1 shall be rated Tier 3 per EPA requirements. All modeling assumes the use of this equipment and is therefore a condition of the project.
2. During construction of the project, the project would be required to maintain daily dust suppression onsite at all times.
3. The project will provide wheel shakers at both the exit of the construction site to minimize dust being tracked off the project site and onto the roadways.

**Table 4.1: Expected Construction Emissions without Mitigation – Lb/Day**

Year	ROG	NO <sub>x</sub>	CO	SO <sub>x</sub>	PM <sub>10</sub> (Dust)	PM <sub>10</sub> (Exhaust)	PM <sub>10</sub> (Total)	PM <sub>2.5</sub> (Dust)	PM <sub>2.5</sub> (Exhaust)	PM <sub>2.5</sub> (Total)
2024	69.93	66.19	50.26	0.16	1,100.65	2.65	1,101.46	110.82	2.44	111.57
2025	69.64	29.54	38.21	0.14	1,100.65	0.73	1,101.38	110.82	0.68	111.50
Significance Threshold (lb/day)	75	100	550	150	-	-	150	-	-	150
ICAPCD Impact?	No	No	No	No	-	-	Yes	-	-	No

Based on the modeling results, the project would exceed ICAPCD standards for PM10 and is largely attributed to the 24,250 CY of ballast and roadways that will be imported to the site during Grading and Building Construction activities. It was found that all PM10 impacts could be reduced to less than significant if 100% of all hauling trucks were to utilize paved roadway sections only. A haul route for stone and construction materials would need to be prepared to the satisfaction of ICAPCD showing the route is 100% paved. Table 4.2 shows the mitigated emissions which are less than significant.

AQMM-1: The Project shall prepare a haul route plan for all construction materials to include building materials, ballast stone, road base or import materials requiring hauling. The haul route plan shall be approved to the satisfaction of ICAPCD and shall be over a 100% paved roadway surface. In addition, all employees working on the Green Valley Logistics Project shall be trained and sign off that each trip to and from the site would be on 100% paved surfaces.



**Table 4.2: Expected Construction Emissions with Mitigation – Lb/Day**

Year	ROG	NO <sub>x</sub>	CO	SO <sub>x</sub>	PM <sub>10</sub> (Dust)	PM <sub>10</sub> (Exhaust)	PM <sub>10</sub> (Total)	PM <sub>2.5</sub> (Dust)	PM <sub>2.5</sub> (Exhaust)	PM <sub>2.5</sub> (Total)
2024	69.14	55.68	62.60	0.16	14.41	0.42	14.83	6.58	0.42	6.99
2025	68.96	32.54	41.73	0.14	6.11	0.33	6.44	1.67	0.32	1.99
Significance Threshold (lb/day)	75	100	550	150	-	-	150	-	-	150
ICAPCD Impact?	No	No	No	No	-	-	No	-	-	No

Potential onsite odor generators would include short term construction odors from activities such as paving and possibly painting as well as exhaust from construction equipment. Odors created during short term construction activities would most likely be from placing asphalt which has a slight odor from the bitumen and solvents used within hot asphalt. Since the nearest sensitive receptor is located just over 0.25 miles from the site, a less than significant odor impact from construction is expected.

**4.2 Construction Health Risks**

Based upon the annual air quality modeling results attached to this report, worst-case unmitigated PM<sub>10</sub> from exhaust emissions would cumulatively produce 0.0346 tons over the construction duration of 546-days or an average of 0.00066 grams/second. The average emission rate over the grading area is 5.76x10<sup>-10</sup> g/m<sup>2</sup>/s, which was calculated as follows:

$$\frac{0.00066 \frac{\text{grams}}{\text{second}}}{285 \text{ acres} * 4,046 \frac{\text{meters}^2}{\text{acre}}} = 5.76 * 10^{-10} \frac{\text{grams}}{\text{meters}^2 \text{ second}}$$

Utilizing the AERMOD dispersion model, we find that the worst-case annual concentration at any of the residential receptors is 0.0030 µg/m<sup>3</sup> during construction. Utilizing the risk equation identified above in Section 3.1, the inhalation cancer risk for the closest residential receptor was found to be 0.77 per one million exposed which would be considered a less than significant impact.

There are known acute and chronic health risks associated with diesel exhaust which are considered non-cancer risks. These risks are calculated based on methods identified in Section 3.1 of this report. From this we find that the annual concentration of 0.0030 µg/m<sup>3</sup> divided by the Chronic REL of 5 µg/m<sup>3</sup> yields a Health Hazard Index less than one. Therefore, no non-cancer risks are expected and all health risks are considered less than significant.

As shown in Figure 3-A above, two residential receptors were modeled. Since the closest receptor had less than significant impacts, the further one would also have less than significant impacts. The AERMOD output is provided as **Attachment C** to this report.

#### 4.3 Operational Findings

The Green Logistics Development Project would bring roughly 4 locomotives into the 1.75 mile loop daily. These trains would be expected to generate air quality emissions daily. The emission rates were provided in Section 3.4 of this report. Table 4.3 below shows the estimated emissions generated from these locomotives daily.

**Table 4.3: Expected Rail Emissions**

PM10	NO <sub>x</sub>	CO	Units
0.16836	6.1587	1.28	(g/bhp-hr)
4000	4000	4000	horsepower
4	4	4	trains
1.75	1.75	1.75	miles
1	1	1	miles/hour
0.1	0.1	0.1	Load Factor
1.75	1.75	1.75	hours
6300	6300	6300	Seconds
0.0748	2.7372	0.5689	Grams/sec
471.41	17244.36	3584.00	Grams
<b>1.04</b>	<b>38.02</b>	<b>7.90</b>	<b>Pounds/day</b>

Project Buildout is expected in 2025. The expected daily pollutant generation is calculated with CALEEMOD 2020.4.0 and includes assumptions discussed in Section 3 of this report. The daily pollutants calculated for summer and winter are shown in Tables 4.3 and 4.4, respectively. In addition, Tables 4.4 and 4.5 include the emissions from the expected locomotives onsite daily.

**Table 4.4: Expected Daily Pollutant Generation - Summer**

	ROG	NO <sub>x</sub>	CO	SO <sub>x</sub>	PM <sub>10</sub>	PM <sub>2.5</sub>
Area Source Emission Estimates (Lb/Day)	26.61	0.00	0.14	0.00	0.00	0.00
Energy Source Emissions (Lb/Day)	0.11	0.98	0.82	0.01	0.07	0.07
Operational Vehicle Emissions (Lb/Day)	0.03	0.02	0.32	0.00	10.51	1.06
Daily Locomotives	-	38.02	7.9	-	1.04	-
<b>Total (Lb/Day)</b>	<b>26.75</b>	<b>39.02</b>	<b>9.18</b>	<b>0.01</b>	<b>11.62</b>	<b>1.13</b>
ICAPCD Thresholds	55	55	550	150	150	150
Significant?	No	No	No	No	No	No
Daily pollutant generation assumes trip distances within CALLEEMOD 2020.4.0						

**Table 4.5: Expected Daily Pollutant Generation - Winter**

	ROG	NO <sub>x</sub>	CO	SO <sub>x</sub>	PM <sub>10</sub>	PM <sub>2.5</sub>
Area Source Emission Estimates (Lb/Day)	26.61	0.00	0.14	0.00	0.00	0.00
Energy Source Emissions (Lb/Day)	0.11	0.98	0.82	0.01	0.07	0.07
Operational Vehicle Emissions (Lb/Day)	0.02	0.02	0.25	0.00	10.51	1.06
Daily Locomotives	-	38.02	7.9	-	1.04	-
<b>Total (Lb/Day)</b>	<b>26.74</b>	<b>39.02</b>	<b>9.11</b>	<b>0.01</b>	<b>11.62</b>	<b>1.13</b>
ICAPCD Thresholds	55	55	550	150	150	150
Significant?	No	No	No	No	No	No
Daily pollutant generation assumes trip distances within CALLEEMOD 2020.4.0						

The proposed Project site is zoned Industrial, and the Project has been designed to be consistent with this zoning designation. The project would generate less than significant direct air quality impacts and by the very nature of the Project would reduce truck trips by greater than two thirds (2/3). According to the traffic study, each truck trip would reduce mileage from roughly 80 miles per day to only 25 miles for the same tasks since materials would be shipped via train instead of individually trucked into the Imperial County area from the Los Angeles area. Given this, since the proposed project would not have any significant direct impacts and would reduce cumulative impacts, the project would not conflict with either the County's AQMP or SIP.

#### 4.4 Operational Health Risks

The Proposed Project would have less than significant operational impacts. However, some of the proposed uses under the Green Valley Logistics Project would require special permits to construct and operate. Separate health risk studies would be required by ICAPCD as part

of the permitting process. Since the proposed uses are consistent with the industrial land use and since the nearest sensitive residential receptor is greater than 0.25 miles away, unmitigable health risk impacts would be highly unlikely. Based on this, operational health risks from a planning perspective would be considered less than significant though should be specifically analyzed during the permitting phase of this Project.

#### 4.5 Cumulative Impact Findings

Cumulative impacts would exist when either there are direct air quality impacts or when multiple construction projects occur within the same area simultaneously. To illustrate this, if a project were to produce air quality emissions simultaneous to a nearby construction project the addition of both project emissions to the environment could exceed significance thresholds. For this project, the construction emissions were found to be less than significant as shown in Table 4.1 above. These impacts were discovered to be regional as opposed to onsite since these impacts would be on Imperial County roads which are not paved. The Project calls for specific mitigation measures to require that all hauling and employee trips during construction utilize only 100% paved roadway sections. It will be up to the Construction Contractor to ensure that a haul route plan is approved by the ICAPCD by showing that the entire route is 100% paved. In addition, the Construction Contractor shall educate construction staff to only drive on 100% paved roads when traveling to or from the Project site.

The proposed Project site is zoned industrial and the Project has been designed to be consistent with this zoning designation. The project would generate less than significant direct air quality impacts and by the very nature of the Project would reduce regional truck trips by greater than two thirds (2/3) since each truck trip would reduce mileage from roughly 80 miles per day to only 25 for the same tasks since the emissions would be bulk via train instead of individually trucked into the Imperial County area from the Los Angeles area. Given this, the proposed Project would also have less than significant Cumulative impacts.

#### 4.6 Conclusion of Findings

During construction, the proposed Project would be expected to produce significant PM10 impacts under the California Environmental Quality Act or exceed thresholds of significance established by the Imperial County Air Pollution Control District (ICAPCD). The primary reason for these impacts is that not all roads in the Imperial County are paved and it is assumed that some of the roads traveled to and from the site may be unpaved. These PM10 impacts would be reduced to less than significant if all trucks and employee trips commit to

driving on 100% paved surfaces. Therefore, Mitigation Measure AQMM-1 would be required to ensure that PM10 impacts are less than significant.

AQMM-1: The Project shall prepare a haul route plan for all construction materials to include ballast stone, road base or import materials requiring hauling. The haul route plan shall be approved to the satisfaction of ICAPCD and shall be over a 100% paved roadway surface. In addition, all employees working on the Green Valley Logistics Project shall be trained and sign off that each trip to and from the site would be on 100% paved surfaces.

The proposed Project would not generate significant operational impacts and would generally be considered to have less than significant air quality impacts.

The project would not be expected to generate offensive objective odors during either the construction or operation phase of the Projects project since residential receptors are greater than 0.25 miles from the site.

Per the requirements of ICAPCD, the since the Project would increase PM10 emissions to a Tier 2 impact without specific mitigation measures, the Project would also be required to implement standard mitigation measures for construction activities which are identified below:

*Standard Construction Site Design Measures:*

1. *Use of alternative fueled or catalyst equipped diesel construction equipment, including all off-road and portable diesel powered equipment.*
2. *Minimize idling time either by shutting equipment off when not in use or reducing the time of idling to 5 minutes as a maximum.*
3. *Limit, to the extent feasible, the hours of operation of heavy duty equipment and/or the amount of equipment in use.*
4. *Replace fossil fueled equipment with electrically driven equivalents (provided they are not run via a portable generator set).*

The project will include a number of design features during construction and since they are assumed in air quality modeling are required as part of this Project.

1. Diesel equipment required which does not satisfy SDM 1 in Section 2.3 above shall be rated Tier 3 per EPA requirements. All modeling assumes the use of this equipment and is therefore a condition of this Project.
2. All construction workers, vendors and haul trucks will be required to utilize paved roadways.



3. Operational On-Road trips shall not operate on unpaved dirt roads.
4. During construction of the project, the project would be required to maintain daily dust suppression using a water truck operating continuously while off road vehicles are driving on the Project site.
5. The project will provide wheel shakers at the exit of the construction site to minimize dust being tracked off the project site and onto the roadways.

A construction health risk analysis was performed and was found to generate less than significant construction health risks at the nearest residential receptor. Based on this a less than significant construction health risk is expected.

The Project is proposing a number of uses that will require special permits to construct and special permits to operate. ICAPCD will require that these uses conduct specific health risk analysis showing that health risks are less than significant at potentially exposed workers and the residential receptors in the area. Since the land uses proposed would be consistent with the Land Use, significant unmitigable health risks would not be likely. For planning purposes, a less than significant health risk during operations would be expected which will ultimately be concluded once these aforementioned Permits are issued by ICAPCD.

The proposed Project is consistent with the existing land use zoning designation which is designated as industrial. Also, since no unmitigable direct or cumulative impacts are expected, the proposed project would be consistent with the AQMP and SIP. Given this, less than significant cumulative operational impacts would be expected.

## **6.0 REFERENCES**

- ARB. (2023). *Air Quality Data Statistics*. Retrieved from <https://www.arb.ca.gov/adam>:  
<https://www.arb.ca.gov/adam>
- California Air Resources Board. (5/4/2016). *www.arb.ca.gov*. Retrieved from Ambient Air Quality Standards: <http://www.arb.ca.gov/research/aaqs/aaqs2.pdf>
- CAPCOA. (2017). *Appendix A - Calculation Details for CalEEMod*. Retrieved from [http://www.aqmd.gov/docs/default-source/caleemod/02\\_appendix-a2016-3-2.pdf?sfvrsn=6](http://www.aqmd.gov/docs/default-source/caleemod/02_appendix-a2016-3-2.pdf?sfvrsn=6)
- EPA. (2009). *Emission Factors for Locomotives - EPA-420-F-09-025*. Retrieved from <https://nepis.epa.gov/Exe/ZyPDF.cgi/P100500B.PDF?Dockey=P100500B.PDF>
- ICAPCD. (2017). *CEQA Air Quality Handbook*. Retrieved from <https://www.co.imperial.ca.us/AirPollution/PlanningDocs/CEQAHandbk.pdf>
- ICAPCD. (2018). *IMPERIAL COUNTY 2018 REDESIGNATION REQUEST AND MAINTENANCE PLAN FOR PARTICULATE MATTER LESS THAN 10 MICRONS IN DIAMETER*. Retrieved from <https://ww3.arb.ca.gov/planning/sip/planarea/imperial/sip.pdf>
- LL&G. (2023). *TRANSPORTATION IMPACT ANALYSIS GREEN VALLEY LOGISTICS CENTER*.
- LLG Engineers. (2020). *TRANSPORTATION IMPACT ANALYSIS - HUDSON RANCH MINERAL RECOVERY*.
- OEHHA. (2015). *Air Toxics Hot Spots Program - Risk Assessment Guidelines - Guidance Manual for Preparation of Health Risk Assessments*. OEHHA.
- OEHHA. (February 2015). *Air Toxics Hot Spots Program - Risk Assessment Guidelines - Guidance Manual for Preparation of Health Risk Assessments*. OEHHA. Retrieved from <https://oehha.ca.gov/air/crn/notice-adoption-air-toxics-hot-spots-program-guidance-manual-preparation-health-risk-0>
- The Holt Group. (2023). *Project Site Layout*.
- US EPA. (2012). *The Emergency Planning and Community Right-to-Know Act*. Retrieved from [https://www.epa.gov/sites/production/files/2015-05/documents/epcra\\_fact\\_sheet.pdf](https://www.epa.gov/sites/production/files/2015-05/documents/epcra_fact_sheet.pdf)

## **7.0 CERTIFICATIONS**

The contents of this report represent an accurate depiction of the air quality environment and impacts within and surrounding the proposed development. This report was prepared utilizing the latest emission rates and reduction methodologies.

**DRAFT**

Jeremy Loudon, Principal  
Ldn Consulting, Inc.  
(760) 473-1253  
jloudon@ldnconsulting.net

Date July 18, 2023

**ATTACHMENT A**

CalEEMod (Unmitigated)

Green Valley Logistics (Imperial County) - Imperial County, Summer

**EMFAC Off-Model Adjustment Factors for Gasoline Light Duty Vehicle to Account for the SAFE Vehicle Rule Applied**

**Green Valley Logistics (Imperial County)**

Imperial County, Summer

**1.0 Project Characteristics**

**1.1 Land Usage**

Land Uses	Size	Metric	Lot Acreage	Floor Surface Area	Population
General Heavy Industry	50.00	1000sqft	207.00	50,000.00	0
Unrefrigerated Warehouse-Rail	1,000.00	1000sqft	64.00	1,000,000.00	0
Parking Lot	350.00	Space	4.00	140,000.00	0
Convenience Market with Gas Pumps	16.00	Pump	9.50	2,258.80	0

**1.2 Other Project Characteristics**

Urbanization	Urban	Wind Speed (m/s)	3.4	Precipitation Freq (Days)	12
Climate Zone	15			Operational Year	2025

Utility Company Imperial Irrigation District

CO2 Intensity (lb/MW/hr)	189.98	CH4 Intensity (lb/MW/hr)	0.033	N2O Intensity (lb/MW/hr)	0.004
--------------------------	--------	--------------------------	-------	--------------------------	-------

**1.3 User Entered Comments & Non-Default Data**

Project Characteristics -

Land Use - 284.5 acres site

Construction Phase - Construction Schedule

Off-road Equipment - CE

Trips and VMT - Project would use 24,250 trucks to deliver 24CY of stone material per truck during Grading and Building Construction. Per Mitigation Measure AQMM-1... all haul routes and worker trips to and from the site shall be 100% paved.

On-road Fugitive Dust - The Project assumes 90% paved.

Grading - 1,000 CY of export grubbed material

Architectural Coating -







Green Valley Logistics (Imperial County) - Imperial County, Summer

**EMFAC Off-Model Adjustment Factors for Gasoline Light Duty Vehicle to Account for the SAFE Vehicle Rule Applied**

tblFleetMix	MCY	0.02	0.00
tblFleetMix	MDV	0.14	0.00
tblFleetMix	MH	3.3880e-003	0.00
tblFleetMix	MHD	8.3250e-003	0.00
tblFleetMix	OBUS	9.4100e-004	0.00
tblFleetMix	SBUS	7.5200e-004	0.00
tblFleetMix	UBUS	1.1800e-004	0.00
tblGrading	MaterialExported	0.00	1,000.00
tblLandUse	LotAcreage	1.15	207.00
tblLandUse	LotAcreage	22.96	64.00
tblLandUse	LotAcreage	3.15	4.00
tblLandUse	LotAcreage	0.05	9.50
tblOffRoadEquipment	OffRoadEquipmentUnitAmount	1.00	2.00
tblOnRoadDust	HaulingPercentPave	50.00	90.00
tblOnRoadDust	HaulingPercentPave	50.00	90.00
tblOnRoadDust	HaulingPercentPave	50.00	90.00
tblOnRoadDust	HaulingPercentPave	50.00	90.00
tblOnRoadDust	VendorPercentPave	50.00	90.00
tblOnRoadDust	VendorPercentPave	50.00	90.00
tblOnRoadDust	VendorPercentPave	50.00	90.00
tblOnRoadDust	VendorPercentPave	50.00	90.00
tblOnRoadDust	WorkerPercentPave	50.00	90.00
tblOnRoadDust	WorkerPercentPave	50.00	90.00
tblOnRoadDust	WorkerPercentPave	50.00	90.00
tblOnRoadDust	WorkerPercentPave	50.00	90.00
tblOnRoadDust	RoadPercentPave	50	90

**FEC ORIGINAL PKG**



Green Valley Logistics (Imperial County) - Imperial County, Summer

**EMFAC Off-Model Adjustment Factors for Gasoline Light Duty Vehicle to Account for the SAFE Vehicle Rule Applied**

tbiSolidWaste	SolidWasteGenerationRate	940.00	188.00
tbiTripsAndVMT	HaulingTripNumber	0.00	2,965.35
tbiTripsAndVMT	HaulingTripNumber	0.00	21,284.65
tbiVehicleTrips	DV_TP	21.00	0.00
tbiVehicleTrips	DV_TP	5.00	0.00
tbiVehicleTrips	DV_TP	5.00	0.00
tbiVehicleTrips	PB_TP	65.00	0.00
tbiVehicleTrips	PB_TP	3.00	0.00
tbiVehicleTrips	PB_TP	3.00	0.00
tbiVehicleTrips	PR_TP	14.00	0.00
tbiVehicleTrips	PR_TP	92.00	100.00
tbiVehicleTrips	PR_TP	92.00	0.00
tbiVehicleTrips	ST_TR	322.50	0.00
tbiVehicleTrips	ST_TR	6.42	0.43
tbiVehicleTrips	ST_TR	1.74	0.00
tbiVehicleTrips	SU_TR	322.50	0.00
tbiVehicleTrips	SU_TR	5.09	0.43
tbiVehicleTrips	SU_TR	1.74	0.00
tbiVehicleTrips	WD_TR	322.50	0.00
tbiVehicleTrips	WD_TR	3.93	0.43
tbiVehicleTrips	WD_TR	1.74	0.00
tbiWater	IndoorWaterUseRate	167,314.87	0.00
tbiWater	IndoorWaterUseRate	11,562,500.00	0.00
tbiWater	IndoorWaterUseRate	231,250,000.00	12,000,000.00
tbiWater	OutdoorWaterUseRate	102,547.82	0.00
tbiWater	OutdoorWaterUseRate	0.00	46,650,000.00

FEC ORIGINAL PKG

Green Valley Logistics (Imperial County) - Imperial County, Summer

**EMFAC Off-Model Adjustment Factors for Gasoline Light Duty Vehicle to Account for the SAFE Vehicle Rule Applied**

**2.1 Overall Construction (Maximum Daily Emission)**

Unmitigated Construction

Year	ROG	NOx	CO	SO2	Fugitive PM10	Exhaust PM10	PM10 Total	Fugitive PM2.5	Exhaust PM2.5	PM2.5 Total	Bio- CO2	NBio- CO2	Total CO2	CH4	N2O	CO2e
lb/day																
2024	69.9254	66.1857	50.2558	0.1590	1,100.651	2.6493	1,101.458	110.8170	2.4404	111.5737	0.0000	16,201.82	16,201.82	3.1544	1.3140	16,633.17
					1		1					72	72			86
2025	69.6396	29.5379	38.2086	0.1408	1,100.651	0.7267	1,101.377	110.8170	0.6815	111.4985	0.0000	14,476.74	14,476.74	1.0576	1.2790	14,884.32
					1		9					38	38			61
Maximum	69.9254	66.1857	50.2558	0.1590	1,100.651	2.6493	1,101.458	110.8170	2.4404	111.5737	0.0000	16,201.82	16,201.82	3.1544	1.3140	16,633.17
					1		1					72	72			86

Mitigated Construction

Year	ROG	NOx	CO	SO2	Fugitive PM10	Exhaust PM10	PM10 Total	Fugitive PM2.5	Exhaust PM2.5	PM2.5 Total	Bio- CO2	NBio- CO2	Total CO2	CH4	N2O	CO2e
lb/day																
2024	69.1412	55.6766	62.6003	0.1590	1,100.651	0.4214	1,100.984	110.8170	0.4177	111.1428	0.0000	16,201.82	16,201.82	3.1544	1.3140	16,633.17
					1		8					72	72			86
2025	68.9575	32.5430	41.7256	0.1408	1,100.651	0.3319	1,100.983	110.8170	0.3241	111.1411	0.0000	14,476.74	14,476.74	1.0576	1.2790	14,884.32
					1		1					38	38			61
Maximum	69.1412	55.6766	62.6003	0.1590	1,100.651	0.4214	1,100.984	110.8170	0.4177	111.1428	0.0000	16,201.82	16,201.82	3.1544	1.3140	16,633.17
					1		8					72	72			86

EEC ORIGINAL PKG



Green Valley Logistics (Imperial County) - Imperial County, Summer

**EMFAC Off-Model Adjustment Factors for Gasoline Light Duty Vehicle to Account for the SAFE Vehicle Rule Applied**

	ROG	NOx	CO	SO2	Fugitive PM10	Exhaust PM10	PM10 Total	Fugitive PM2.5	Exhaust PM2.5	PM2.5 Total	Bio- CO2	NEI(e)-CO2	Total CO2	CH4	N2O	CO2e
Percent Reduction	1.05	7.84	-17.93	0.00	0.00	77.69	0.04	0.00	76.24	0.35	0.00	0.00	0.00	0.00	0.00	0.00

Green Valley Logistics (Imperial County) - Imperial County, Summer

**EMFAC Off-Model Adjustment Factors for Gasoline Light Duty Vehicle to Account for the SAFE Vehicle Rule Applied**

**2.2 Overall Operational  
Unmitigated Operational**

Category	ROG	NOx	CO	SO2	Fugitive PM10	Exhaust PM10	PM10 Total	Fugitive PM2.5	Exhaust PM2.5	PM2.5 Total	BiO- CO2	NBiO- CO2	Total CO2	CH4	N2O	CO2e
lb/day																
Area	26.6059	1.3100e-003	0.1442	1.0000e-005	5.1000e-004	5.1000e-004	5.1000e-004	5.1000e-004	5.1000e-004	5.1000e-004		0.3089	0.3089	8.1000e-004		0.3301
Energy	0.1073	0.9754	0.8194	5.8500e-003	0.0741	0.0741	0.0741	0.0741	0.0741	0.0741		1,170.4978	1,170.4978	0.0224	0.0215	1,177.4535
Mobile	0.0341	0.0165	0.3225	8.4000e-004	10.5142	4.3000e-004	10.5146	1.0632	4.0000e-004	1.0636		87.1296	87.1296	2.3000e-003	2.3000e-003	87.8724
<b>Total</b>	<b>26.7473</b>	<b>0.9932</b>	<b>1.2860</b>	<b>6.7000e-003</b>	<b>10.5142</b>	<b>0.0751</b>	<b>10.5892</b>	<b>1.0632</b>	<b>0.0750</b>	<b>1.1383</b>		<b>1,257.9373</b>	<b>1,257.9373</b>	<b>0.0255</b>	<b>0.0238</b>	<b>1,265.6559</b>

**Mitigated Operational**

Category	ROG	NOx	CO	SO2	Fugitive PM10	Exhaust PM10	PM10 Total	Fugitive PM2.5	Exhaust PM2.5	PM2.5 Total	BiO- CO2	NBiO- CO2	Total CO2	CH4	N2O	CO2e
lb/day																
Area	26.6059	1.3100e-003	0.1442	1.0000e-005	5.1000e-004	5.1000e-004	5.1000e-004	5.1000e-004	5.1000e-004	5.1000e-004		0.3089	0.3089	8.1000e-004		0.3301
Energy	0.1073	0.9754	0.8194	5.8500e-003	0.0741	0.0741	0.0741	0.0741	0.0741	0.0741		1,170.4978	1,170.4978	0.0224	0.0215	1,177.4535
Mobile	0.0341	0.0165	0.3225	8.4000e-004	10.5142	4.3000e-004	10.5146	1.0632	4.0000e-004	1.0636		87.1296	87.1296	2.3000e-003	2.3000e-003	87.8724
<b>Total</b>	<b>26.7473</b>	<b>0.9932</b>	<b>1.2860</b>	<b>6.7000e-003</b>	<b>10.5142</b>	<b>0.0751</b>	<b>10.5892</b>	<b>1.0632</b>	<b>0.0750</b>	<b>1.1383</b>		<b>1,257.9373</b>	<b>1,257.9373</b>	<b>0.0255</b>	<b>0.0238</b>	<b>1,265.6559</b>

EEC ORIGINAL PKG

Green Valley Logistics (Imperial County) - Imperial County, Summer

**EMFAC Off-Model Adjustment Factors for Gasoline Light Duty Vehicle to Account for the SAFE Vehicle Rule Applied**

ROG	NOx	CO	SO2	Fugitive PM10	Exhaust PM10	PM10 Total	Fugitive PM2.5	Exhaust PM2.5	PM2.5 Total	Bio-CO2	NIlo-CO2	Total CO2	CH4	N2O	CO2e
0.00	0.00	0.00	0.00	0.00	0.00	0.00	0.00	0.00	0.00	0.00	0.00	0.00	0.00	0.00	0.00

**3.0 Construction Detail**

**Construction Phase**

Phase Number	Phase Name	Phase Type	Start Date	End Date	Num Days Week	Num Days	Phase Description
1	Site Preparation	Site Preparation	1/1/2024	3/1/2024	5	45	
2	Grading	Grading	2/1/2024	4/3/2024	5	45	
3	Building Construction	Building Construction	4/4/2024	6/30/2025	5	323	
4	Paving	Paving	4/4/2024	5/8/2024	5	25	
5	Architectural Coating	Architectural Coating	7/1/2024	5/9/2025	5	225	

**Acres of Grading (Site Preparation Phase): 67.5**

**Acres of Grading (Grading Phase): 135**

**Acres of Paving: 4**

**Residential Indoor: 0; Residential Outdoor: 0; Non-Residential Indoor: 1,578,388; Non-Residential Outdoor: 526,129; Striped Parking Area: 8,400 (Architectural Coating – sqft)**

**Offroad Equipment**

Phase Name	Offroad Equipment Type	Amount	Usage Hours	Horse Power	Load Factor
Site Preparation	Rubber Tired Dozers	3	8.00	247	0.40
Site Preparation	Tractors/Loaders/Backhoes	4	8.00	97	0.37
Grading	Excavators	2	8.00	158	0.38
Grading	Graders	1	8.00	187	0.41
Grading	Rubber Tired Dozers	1	8.00	247	0.40
Grading	Scrapers	2	8.00	367	0.48

Green Valley Logistics (Imperial County) - Imperial County, Summer

**EMFAC Off-Model Adjustment Factors for Gasoline Light Duty Vehicle to Account for the SAFE Vehicle Rule Applied**

Grading	Tractors/Loaders/Backhoes	2	8.00	97	0.37
Building Construction	Aerial Lifts	2	8.00	63	0.31
Building Construction	Cranes	2	7.00	231	0.29
Building Construction	Rough Terrain Forklifts	2	8.00	100	0.40
Building Construction	Tractors/Loaders/Backhoes	3	7.00	97	0.37
Building Construction	Welders	1	8.00	46	0.45
Paving	Pavers	2	8.00	130	0.42
Paving	Paving Equipment	2	8.00	132	0.36
Paving	Rollers	2	8.00	80	0.38
Architectural Coating	Air Compressors	1	6.00	78	0.48

**Trips and VMI**

Phase Name	Offroad Equipment Count	Worker Trip Number	Vendor Trip Number	Hauling Trip Number	Worker Trip Length	Vendor Trip Length	Hauling Trip Length	Worker Vehicle Class	Vendor Vehicle Class	Hauling Vehicle Class
Site Preparation	7	18.00	0.00	125.00	7.30	8.90	20.00	LD_Mix	HDT_Mix	HHDT
Grading	8	20.00	0.00	2,965.35	7.30	8.90	20.00	LD_Mix	HDT_Mix	HHDT
Building Construction	10	501.00	195.00	21,284.65	7.30	8.90	20.00	LD_Mix	HDT_Mix	HHDT
Paving	6	15.00	0.00	0.00	7.30	8.90	20.00	LD_Mix	HDT_Mix	HHDT
Architectural Coating	1	100.00	0.00	0.00	7.30	8.90	20.00	LD_Mix	HDT_Mix	HHDT

**3. Mitigation Measures Construction**

- Use Cleaner Engines for Construction Equipment
- Use DPF for Construction Equipment
- Water Exposed Area
- Water Unpaved Roads
- Reduce Vehicle Speed on Unpaved Roads

Green Valley Logistics (Imperial County) - Imperial County, Summer

**EMFAC Off-Model Adjustment Factors for Gasoline Light Duty Vehicle to Account for the SAFE Vehicle Rule Applied**

**3.2 Site Preparation - 2024**

**Unmitigated Construction On-Site**

Category	ROG	NOx	CO	SO2	Fugitive PM10	Exhaust PM10	PM10 Total	Fugitive PM2.5	Exhaust PM2.5	PM2.5 Total	Bio- CO2	NBio- CO2	Total CO2	CH4	N2O	CO2e
	lb/day															
Fugitive Dust					19.6614	0.0000	19.6614	10.1031	0.0000	10.1031			0.0000			0.0000
Off-Road	2.6609	27.1760	18.3356	0.0381		1.2294	1.2294		1.1310	1.1310	3,688.010	0	3,688.010	1.1928		3,717.8294
<b>Total</b>	<b>2.6609</b>	<b>27.1760</b>	<b>18.3356</b>	<b>0.0381</b>	<b>19.6614</b>	<b>1.2294</b>	<b>20.8908</b>	<b>10.1031</b>	<b>1.1310</b>	<b>11.2341</b>	<b>3,688.010</b>	<b>0</b>	<b>3,688.010</b>	<b>1.1928</b>		<b>3,717.8294</b>

**Unmitigated Construction Off-Site**

Category	ROG	NOx	CO	SO2	Fugitive PM10	Exhaust PM10	PM10 Total	Fugitive PM2.5	Exhaust PM2.5	PM2.5 Total	Bio- CO2	NBio- CO2	Total CO2	CH4	N2O	CO2e
	lb/day															
Hauling	6.6900e-003	0.2657	0.0802	1.4700e-003	8.2210	3.3800e-003	8.2244	0.8283	3.2300e-003	0.8316			156.2216	4.5000e-004	0.0246	163.5508
Vendor	0.0000	0.0000	0.0000	0.0000	0.0000	0.0000	0.0000	0.0000	0.0000	0.0000			0.0000	0.0000	0.0000	0.0000
Worker	0.0726	0.0292	0.4433	9.1000e-004	19.4292	5.0000e-004	19.4297	1.9541	4.6000e-004	1.9545	93.9181	0	93.9181	3.2400e-003	2.8700e-003	94.8555
<b>Total</b>	<b>0.0793</b>	<b>0.2949</b>	<b>0.5234</b>	<b>2.3800e-003</b>	<b>27.6502</b>	<b>3.8800e-003</b>	<b>27.6541</b>	<b>2.7824</b>	<b>3.6900e-003</b>	<b>2.7861</b>	<b>250.1396</b>	<b>0</b>	<b>250.1396</b>	<b>3.6900e-003</b>	<b>0.0274</b>	<b>258.4063</b>

EEC ORIGINAL PKG



Green Valley Logistics (Imperial County) - Imperial County, Summer

**EMFAC Off-Model Adjustment Factors for Gasoline Light Duty Vehicle to Account for the SAFE Vehicle Rule Applied**

**3.2 Site Preparation - 2024  
Mitigated Construction On-Site**

Category	ROG	NOx	CO	SO2	Fugitive PM10	Exhaust PM10	PM10 Total	Fugitive PM2.5	Exhaust PM2.5	PM2.5 Total	Bio- CO2	NBio- CO2	Total CO2	CH4	N2O	CO2e
lb/day																
Fugitive Dust					8.8477	0.0000	8.8477	4.5464	0.0000	4.5464			0.0000			0.0000
Off-Road	0.9312	19.0656	22.9600	0.0381		0.1419	0.1419		0.1419	0.1419	0.0000	3,688.010	3,688.010	1.1928		3,717.829
<b>Total</b>	<b>0.9312</b>	<b>19.0656</b>	<b>22.9600</b>	<b>0.0381</b>	<b>8.8477</b>	<b>0.1419</b>	<b>8.9896</b>	<b>4.5464</b>	<b>0.1419</b>	<b>4.6883</b>	<b>0.0000</b>	<b>3,688.010</b>	<b>3,688.010</b>	<b>1.1928</b>		<b>3,717.829</b>

**Mitigated Construction Off-Site**

Category	ROG	NOx	CO	SO2	Fugitive PM10	Exhaust PM10	PM10 Total	Fugitive PM2.5	Exhaust PM2.5	PM2.5 Total	Bio- CO2	NBio- CO2	Total CO2	CH4	N2O	CO2e
lb/day																
Hauling	6.6900e-003	0.2657	0.0802	1.4700e-003	8.2210	3.3800e-003	8.2244	0.8283	3.2300e-003	0.8316		156.2216	156.2216	4.5000e-004	0.0246	163.5508
Vendor	0.0000	0.0000	0.0000	0.0000	0.0000	0.0000	0.0000	0.0000	0.0000	0.0000		0.0000	0.0000	0.0000	0.0000	0.0000
Worker	0.0726	0.0292	0.4433	9.1000e-004	19.4292	5.0000e-004	19.4297	1.9541	4.6000e-004	1.9545		93.9181	93.9181	3.2400e-003	2.8700e-003	94.8555
<b>Total</b>	<b>0.0793</b>	<b>0.2949</b>	<b>0.5234</b>	<b>2.3800e-003</b>	<b>27.6502</b>	<b>3.8800e-003</b>	<b>27.6541</b>	<b>2.7824</b>	<b>3.6900e-003</b>	<b>2.7861</b>		<b>250.1396</b>	<b>250.1396</b>	<b>3.6900e-003</b>	<b>0.0274</b>	<b>258.4063</b>

EEC ORIGINAL PKG

Green Valley Logistics (Imperial County) - Imperial County, Summer

**EMFAC Off-Model Adjustment Factors for Gasoline Light Duty Vehicle to Account for the SAFE Vehicle Rule Applied**

**3.3 Grading - 2024**

**Unmitigated Construction On-Site**

Category	ROG	NOx	CO	SO2	Fugitive PM10	Exhaust PM10	PM10 Total	Fugitive PM2.5	Exhaust PM2.5	PM2.5 Total	Bio- CO2	NBio- CO2	Total CO2	CH4	N2O	CO2e
	lb/day															
Fugitive Dust					9.2036	0.0000	9.2036	3.6538	0.0000	3.6538			0.0000			0.0000
Off-Road	3.2181	32.3770	27.7228	0.0621		1.3354	1.3354	1.2286	1.2286	2.5640		6,009.748 <sub>7</sub>	6,009.748 <sub>7</sub>	1.9437		6,058.340 <sub>5</sub>
<b>Total</b>	<b>3.2181</b>	<b>32.3770</b>	<b>27.7228</b>	<b>0.0621</b>	<b>9.2036</b>	<b>1.3354</b>	<b>10.5390</b>	<b>3.6538</b>	<b>1.2286</b>	<b>4.8823</b>		<b>6,009.748<sub>7</sub></b>	<b>6,009.748<sub>7</sub></b>	<b>1.9437</b>		<b>6,058.340<sub>5</sub></b>

**Unmitigated Construction Off-Site**

Category	ROG	NOx	CO	SO2	Fugitive PM10	Exhaust PM10	PM10 Total	Fugitive PM2.5	Exhaust PM2.5	PM2.5 Total	Bio- CO2	NBio- CO2	Total CO2	CH4	N2O	CO2e
	lb/day															
Hauling	0.1587	6.3055	1.9017	0.0350	195.0262	0.0801	195.1063	19.6502	0.0767	19.7269		3,706.824 <sub>8</sub>	3,706.824 <sub>8</sub>	0.0107	0.5827	3,880.732 <sub>2</sub>
Vendor	0.0000	0.0000	0.0000	0.0000	0.0000	0.0000	0.0000	0.0000	0.0000	0.0000		0.0000	0.0000	0.0000	0.0000	0.0000
Worker	0.0807	0.0324	0.4925	1.0100e-003	21.5880	5.5000e-004	21.5885	2.1712	5.1000e-004	2.1717		104.3534	104.3534	3.6000e-003	3.1900e-003	105.3950
<b>Total</b>	<b>0.2394</b>	<b>6.3379</b>	<b>2.3942</b>	<b>0.0360</b>	<b>216.6142</b>	<b>0.0807</b>	<b>216.6948</b>	<b>21.8214</b>	<b>0.0772</b>	<b>21.8986</b>		<b>3,811.178<sub>2</sub></b>	<b>3,811.178<sub>2</sub></b>	<b>0.0143</b>	<b>0.5859</b>	<b>3,986.127<sub>2</sub></b>

EEC ORIGINAL PKG

Green Valley Logistics (Imperial County) - Imperial County, Summer

**EMFAC Off-Model Adjustment Factors for Gasoline Light Duty Vehicle to Account for the SAFE Vehicle Rule Applied**

**3.3 Grading - 2024**

**Mitigated Construction On-Site**

Category	ROG	NOx	CO	SO2	Fugitive PM10	Exhaust PM10	PM10 Total	Fugitive PM2.5	Exhaust PM2.5	PM2.5 Total	Bio- CO2	NBio- CO2	Total CO2	CH4	N2O	CO2e
lb/day																
Fugitive Dust					4.1416	0.0000	4.1416	1.6442	0.0000	1.6442			0.0000			0.0000
Off-Road	1.5231	29.9782	36.7226	0.0621		0.1949	0.1949	0.1949	0.0000	0.1949	6,009.748 <sub>7</sub>	6,009.748 <sub>7</sub>	1.9437			6,058.340 <sub>5</sub>
<b>Total</b>	<b>1.5231</b>	<b>29.9782</b>	<b>36.7226</b>	<b>0.0621</b>	<b>4.1416</b>	<b>0.1949</b>	<b>4.3365</b>	<b>1.6442</b>	<b>0.1949</b>	<b>1.8391</b>	<b>6,009.748<sub>7</sub></b>	<b>6,009.748<sub>7</sub></b>	<b>1.9437</b>			<b>6,058.340<sub>5</sub></b>

**Mitigated Construction Off-Site**

Category	ROG	NOx	CO	SO2	Fugitive PM10	Exhaust PM10	PM10 Total	Fugitive PM2.5	Exhaust PM2.5	PM2.5 Total	Bio- CO2	NBio- CO2	Total CO2	CH4	N2O	CO2e
lb/day																
Hauling	0.1587	6.3055	1.9017	0.0350	195.0282	0.0801	195.1063	19.6502	0.0767	19.7269			3,706.824 <sub>8</sub>	0.0107	0.5827	3,880.732 <sub>2</sub>
Vendor	0.0000	0.0000	0.0000	0.0000	0.0000	0.0000	0.0000	0.0000	0.0000	0.0000			0.0000	0.0000	0.0000	0.0000
Worker	0.0807	0.0324	0.4925	1.0100e-003	21.5880	5.5000e-004	21.5885	2.1712	5.1000e-004	2.1717	104.3534	104.3534	3.6000e-003	0.0143	3.1900e-003	105.3950
<b>total</b>	<b>0.2394</b>	<b>6.3379</b>	<b>2.3942</b>	<b>0.0360</b>	<b>216.6142</b>	<b>0.0807</b>	<b>216.6948</b>	<b>21.8214</b>	<b>0.0772</b>	<b>21.8986</b>	<b>3,811.178<sub>2</sub></b>	<b>3,811.178<sub>2</sub></b>	<b>3.811.178<sub>2</sub></b>	<b>0.0143</b>	<b>0.5859</b>	<b>3,986.127<sub>2</sub></b>

EEO ORIGINAL PKG

Green Valley Logistics (Imperial County) - Imperial County, Summer

**EMFAC Off-Model Adjustment Factors for Gasoline Light Duty Vehicle to Account for the SAFE Vehicle Rule Applied**

**3.4 Building Construction - 2024**

**Unmitigated Construction On-Site**

Category	lb/day															
	ROG	NOx	CO	SO2	Fugitive PM10	Exhaust PM10	PM10 Total	Fugitive PM2.5	Exhaust PM2.5	PM2.5 Total	Bio- CO2	NBio- CO2	Total CO2	CH4	N2O	CO2e
Off-Road	1.4682	15.0679	17.4016	0.0311		0.5776	0.5776		0.5352	0.5352		2,970.240	2,970.240	0.9147		2,993.108
<b>Total</b>	<b>1.4682</b>	<b>15.0679</b>	<b>17.4016</b>	<b>0.0311</b>		<b>0.5776</b>	<b>0.5776</b>		<b>0.5352</b>	<b>0.5352</b>		<b>2,970.240</b>	<b>2,970.240</b>	<b>0.9147</b>		<b>2,993.108</b>

**Unmitigated Construction Off-Site**

Category	lb/day															
	ROG	NOx	CO	SO2	Fugitive PM10	Exhaust PM10	PM10 Total	Fugitive PM2.5	Exhaust PM2.5	PM2.5 Total	Bio- CO2	NBio- CO2	Total CO2	CH4	N2O	CO2e
Hauling	0.1587	6.3042	1.9013	0.0350	195.0264	0.0801	195.1065	19.6502	0.0767	19.7269		3,706.078	3,706.078	0.0107	0.5826	3,879.950
Vendor	0.4041	7.3993	3.6202	0.0440	256.9063	0.0719	256.9781	25.9224	0.0687	25.9911		4,625.644	4,625.644	0.0207	0.6355	4,815.532
Worker	2.0211	0.8118	12.3376	0.0253	540.7786	0.0138	540.7924	54.3884	0.0127	54.4011		2,614.052	2,614.052	0.0902	0.0800	2,640.144
<b>Total</b>	<b>2.5839</b>	<b>14.5153</b>	<b>17.8591</b>	<b>0.1043</b>	<b>992.7113</b>	<b>0.1658</b>	<b>992.8770</b>	<b>99.9610</b>	<b>0.1581</b>	<b>100.1191</b>		<b>10,945.77</b>	<b>10,945.77</b>	<b>0.1216</b>	<b>1.2980</b>	<b>11,335.62</b>

EEC ORIGINAL PKG



Green Valley Logistics (Imperial County) - Imperial County, Summer

**EMFAC Off-Model Adjustment Factors for Gasoline Light Duty Vehicle to Account for the SAFE Vehicle Rule Applied**

**3.4 Building Construction - 2024**

**Mitigated Construction On-Site**

Category	ROG	NOx	CO	SO2	Fugitive PM10	Exhaust PM10	PM10 Total	Fugitive PM2.5	Exhaust PM2.5	PM2.5 Total	Bio- CO2	NBio- CO2	Total CO2	CH4	N2O	CO2e
	lb/day															
Off-Road	0.8054	16.7936	20.7901	0.0311		0.1510	0.1510		0.1510	0.1510	0.0000	2,970.2404	2,970.2404	0.9147		2,993.1081
<b>Total</b>	<b>0.8054</b>	<b>16.7936</b>	<b>20.7901</b>	<b>0.0311</b>		<b>0.1510</b>	<b>0.1510</b>		<b>0.1510</b>	<b>0.1510</b>	<b>0.0000</b>	<b>2,970.2404</b>	<b>2,970.2404</b>	<b>0.9147</b>		<b>2,993.1081</b>

**Mitigated Construction Off-Site**

Category	ROG	NOx	CO	SO2	Fugitive PM10	Exhaust PM10	PM10 Total	Fugitive PM2.5	Exhaust PM2.5	PM2.5 Total	Bio- CO2	NBio- CO2	Total CO2	CH4	N2O	CO2e
	lb/day															
Hauling	0.1587	6.3042	1.9013	0.0350	195.0264	0.0801	195.1065	19.6502	0.0767	19.7269		3,706.0781	3,706.0781	0.0107	0.5826	3,879.9504
Vendor	0.4041	7.3993	3.6202	0.0440	256.9063	0.0719	256.9781	25.9224	0.0687	25.9911		4,625.6440	4,625.6440	0.0207	0.6355	4,815.5326
Worker	2.0211	0.8118	12.3376	0.0253	540.7786	0.0138	540.7924	54.3884	0.0127	54.4011		2,614.0525	2,614.0525	0.0902	0.0800	2,640.1449
<b>Total</b>	<b>2.5839</b>	<b>14.5153</b>	<b>17.8591</b>	<b>0.1043</b>	<b>992.7113</b>	<b>0.1658</b>	<b>992.8770</b>	<b>99.9610</b>	<b>0.1561</b>	<b>100.1191</b>		<b>10,945.7746</b>	<b>10,945.7746</b>	<b>0.1216</b>	<b>1.2980</b>	<b>11,335.6279</b>

REC ORIGINAL PKG



Green Valley Logistics (Imperial County) - Imperial County, Summer

**EMFAC Off-Model Adjustment Factors for Gasoline Light Duty Vehicle to Account for the SAFE Vehicle Rule Applied**

**3.4 Building Construction - 2025  
Unmitigated Construction On-Site**

Category	ROG	NOx	CO	SO2	Fugitive PM10	Exhaust PM10	PM10 Total	Fugitive PM2.5	Exhaust PM2.5	PM2.5 Total	Bio- CO2	NBio- CO2	Total CO2	CH4	N2O	CO2e
Off-Road	1.3760	14.0000	17.2964	0.0311		0.5085	0.5085		0.4711	0.4711		2,970.9950	2,970.9950	0.9135		2,993.8323
<b>Total</b>	<b>1.3760</b>	<b>14.0000</b>	<b>17.2964</b>	<b>0.0311</b>		<b>0.5085</b>	<b>0.5085</b>		<b>0.4711</b>	<b>0.4711</b>		<b>2,970.9950</b>	<b>2,970.9950</b>	<b>0.9135</b>		<b>2,993.8323</b>

**Unmitigated Construction Off-Site**

Category	ROG	NOx	CO	SO2	Fugitive PM10	Exhaust PM10	PM10 Total	Fugitive PM2.5	Exhaust PM2.5	PM2.5 Total	Bio- CO2	NBio- CO2	Total CO2	CH4	N2O	CO2e
Hauling	0.1586	6.2224	1.9050	0.0342	195.0284	0.0796	195.1060	19.6502	0.0762	19.7264		3,620.7023	3,620.7023	0.0110	0.5692	3,790.5838
Vendor	0.3928	7.2977	3.5149	0.0432	256.9063	0.0715	256.9778	25.9224	0.0684	25.9908		4,545.3807	4,545.3807	0.0203	0.6206	4,730.8152
Worker	1.8774	0.7272	11.4064	0.0245	540.7786	0.0130	540.7917	54.3884	0.0120	54.4004		2,549.3629	2,549.3629	0.0813	0.0744	2,573.5753
<b>Total</b>	<b>2.4288</b>	<b>14.2473</b>	<b>16.8263</b>	<b>0.1019</b>	<b>992.7113</b>	<b>0.1641</b>	<b>992.8754</b>	<b>99.9610</b>	<b>0.1565</b>	<b>100.1175</b>		<b>10,715.4459</b>	<b>10,715.4459</b>	<b>0.1126</b>	<b>1.2641</b>	<b>11,094.9743</b>

REC ORIGINAL FKG

Green Valley Logistics (Imperial County) - Imperial County, Summer

**EMFAC Off-Model Adjustment Factors for Gasoline Light Duty Vehicle to Account for the SAFE Vehicle Rule Applied**

**3.4 Building Construction - 2025**

**Mitigated Construction On-Site**

Category	ROG	NOx	CO	SO2	Fugitive PM10	Exhaust PM10	PM10 Total	Fugitive PM2.5	Exhaust PM2.5	PM2.5 Total	Bio- CO2	NBio- CO2	Total CO2	CH4	N2O	CO2e
	lb/day															
Off-Road	0.8054	16.7936	20.7901	0.0311		0.1510	0.1510		0.1510	0.1510	0.0000	2,970.995	2,970.995	0.9135		2,993.832
												0	0			3
<b>Total</b>	<b>0.8054</b>	<b>16.7936</b>	<b>20.7901</b>	<b>0.0311</b>		<b>0.1510</b>	<b>0.1510</b>		<b>0.1510</b>	<b>0.1510</b>	<b>0.0000</b>	<b>2,970.995</b>	<b>2,970.995</b>	<b>0.9135</b>		<b>2,993.832</b>
												0	0			3

**Mitigated Construction Off-Site**

Category	ROG	NOx	CO	SO2	Fugitive PM10	Exhaust PM10	PM10 Total	Fugitive PM2.5	Exhaust PM2.5	PM2.5 Total	Bio- CO2	NBio- CO2	Total CO2	CH4	N2O	CO2e
	lb/day															
Hauling	0.1586	6.2224	1.9050	0.0342	195.0264	0.0796	195.1060	19.6502	0.0762	19.7264		3,620.702	3,620.702	0.0110	0.5692	3,790.583
												3	3			8
Vendor	0.3928	7.2977	3.5149	0.0432	256.9063	0.0715	256.9778	25.9224	0.0684	25.9908		4,545.380	4,545.380	0.0203	0.6206	4,730.815
												7	7			2
Worker	1.8774	0.7272	11.4064	0.0245	540.7786	0.0130	540.7917	54.3884	0.0120	54.4004		2,549.362	2,549.362	0.0813	0.0744	2,573.575
												9	9			3
<b>Total</b>	<b>2.4288</b>	<b>14.2473</b>	<b>16.8263</b>	<b>0.1019</b>	<b>992.7113</b>	<b>0.1641</b>	<b>992.8754</b>	<b>99.9610</b>	<b>0.1565</b>	<b>100.1175</b>		<b>10,715.44</b>	<b>10,715.44</b>	<b>0.1126</b>	<b>1.2641</b>	<b>11,094.97</b>
												59	59			43

REC ORIGINAL FKG

Green Valley Logistics (Imperial County) - Imperial County, Summer

**EMFAC Off-Model Adjustment Factors for Gasoline Light Duty Vehicle to Account for the SAFE Vehicle Rule Applied**

**3.5 Paving - 2024**

**Unmitigated Construction On-Site**

Category	lb/day																
	ROG	NOx	CO	SO2	Fugitive PM10	Exhaust PM10	PM10 Total	Fugitive PM2.5	Exhaust PM2.5	PM2.5 Total	Bio- CO2	NBio- CO2	Total CO2	CH4	N2O	CO2e	
Off-Road	0.9882	9.5246	14.6258	0.0228		0.4685	0.4685		0.4310	0.4310		2,207.547 <sup>2</sup>	2,207.547 <sup>2</sup>	0.7140			2,225.396 <sup>3</sup>
Paving	0.4192					0.0000	0.0000		0.0000	0.0000			0.0000				0.0000
<b>Total</b>	<b>1.4074</b>	<b>9.5246</b>	<b>14.6258</b>	<b>0.0228</b>		<b>0.4685</b>	<b>0.4685</b>		<b>0.4310</b>	<b>0.4310</b>		<b>2,207.547<sup>2</sup></b>	<b>2,207.547<sup>2</sup></b>	<b>0.7140</b>			<b>2,225.396<sup>3</sup></b>

**Unmitigated Construction Off-Site**

Category	lb/day																
	ROG	NOx	CO	SO2	Fugitive PM10	Exhaust PM10	PM10 Total	Fugitive PM2.5	Exhaust PM2.5	PM2.5 Total	Bio- CO2	NBio- CO2	Total CO2	CH4	N2O	CO2a	
Hauling	0.0000	0.0000	0.0000	0.0000	0.0000	0.0000	0.0000	0.0000	0.0000	0.0000		0.0000	0.0000	0.0000			0.0000
Vendor	0.0000	0.0000	0.0000	0.0000	0.0000	0.0000	0.0000	0.0000	0.0000	0.0000		0.0000	0.0000	0.0000			0.0000
Worker	0.0605	0.0243	0.3694	7.6000e-004	16.1910	4.1000e-004	16.1914	1.6284	3.8000e-004	1.6288		78.2651	78.2651	2.7000e-003	2.3900e-003		79.0463
<b>Total</b>	<b>0.0605</b>	<b>0.0243</b>	<b>0.3694</b>	<b>7.6000e-004</b>	<b>16.1910</b>	<b>4.1000e-004</b>	<b>16.1914</b>	<b>1.6284</b>	<b>3.8000e-004</b>	<b>1.6288</b>		<b>78.2651</b>	<b>78.2651</b>	<b>2.7000e-003</b>	<b>2.3900e-003</b>		<b>79.0463</b>

EEC ORIGINAL PKG

Green Valley Logistics (Imperial County) - Imperial County, Summer

**EMFAC Off-Model Adjustment Factors for Gasoline Light Duty Vehicle to Account for the SAFE Vehicle Rule Applied**

**3.5 Paving - 2024**

**Mitigated Construction On-Site**

Category	ROG	NOx	CO	SO2	Fugitive PM10	Exhaust PM10	PM10 Total	Fugitive PM2.5	Exhaust PM2.5	PM2.5 Total	Bio- CO2	NBio- CO2	Total CO2	CH4	N2O	CO2e
	lb/day															
Off-Road	0.5609	11.2952	17.2957	0.0228	0.0914	0.0914	0.0914	0.0914	0.0914	0.0914	0.0000	2,207.547 <sub>2</sub>	2,207.547 <sub>2</sub>	0.7140		2,225.396 <sub>3</sub>
Paving	0.4192				0.0000	0.0000	0.0000	0.0000	0.0000	0.0000			0.0000			0.0000
<b>Total</b>	<b>0.9801</b>	<b>11.2952</b>	<b>17.2957</b>	<b>0.0228</b>	<b>0.0914</b>	<b>0.0914</b>	<b>0.0914</b>	<b>0.0914</b>	<b>0.0914</b>	<b>0.0914</b>	<b>0.0000</b>	<b>2,207.547<sub>2</sub></b>	<b>2,207.547<sub>2</sub></b>	<b>0.7140</b>		<b>2,225.396<sub>3</sub></b>

**Mitigated Construction Off-Site**

Category	ROG	NOx	CO	SO2	Fugitive PM10	Exhaust PM10	PM10 Total	Fugitive PM2.5	Exhaust PM2.5	PM2.5 Total	Bio- CO2	NBio- CO2	Total CO2	CH4	N2O	CO2e
	lb/day															
Hauling	0.0000	0.0000	0.0000	0.0000	0.0000	0.0000	0.0000	0.0000	0.0000	0.0000			0.0000	0.0000	0.0000	0.0000
Vendor	0.0000	0.0000	0.0000	0.0000	0.0000	0.0000	0.0000	0.0000	0.0000	0.0000			0.0000	0.0000	0.0000	0.0000
Worker	0.0605	0.0243	0.3694	7.6000e-004	16.1910	4.1000e-004	16.1914	1.6284	3.8000e-004	1.6288		78.2651	78.2651	2.7000e-003	2.3900e-003	79.0463
<b>Total</b>	<b>0.0605</b>	<b>0.0243</b>	<b>0.3694</b>	<b>7.6000e-004</b>	<b>16.1910</b>	<b>4.1000e-004</b>	<b>16.1914</b>	<b>1.6284</b>	<b>3.8000e-004</b>	<b>1.6288</b>		<b>78.2651</b>	<b>78.2651</b>	<b>2.7000e-003</b>	<b>2.3900e-003</b>	<b>79.0463</b>



Green Valley Logistics (Imperial County) - Imperial County, Summer

**EMFAC Off-Model Adjustment Factors for Gasoline Light Duty Vehicle to Account for the SAFE Vehicle Rule Applied**

**3.6 Architectural Coating - 2024**

**Unmitigated Construction On-Site**

Category	ROG	NOx	CO	SO2	Fugitive PM10	Exhaust PM10	PM10 Total	Fugitive PM2.5	Exhaust PM2.5	PM2.5 Total	Blb- CO2	NBlb- CO2	Total CO2	CH4	N2O	CO2e
	lb/day															
Archit. Coating	65.2891					0.0000	0.0000		0.0000	0.0000			0.0000			0.0000
Off-Road	0.1808	1.2188	1.8101	2.9700e-003		0.0609	0.0609		0.0609	0.0609		281.4481	281.4481	0.0159		281.8443
<b>Total</b>	<b>65.4699</b>	<b>1.2188</b>	<b>1.8101</b>	<b>2.9700e-003</b>		<b>0.0609</b>	<b>0.0609</b>		<b>0.0609</b>	<b>0.0609</b>		<b>281.4481</b>	<b>281.4481</b>	<b>0.0159</b>		<b>281.8443</b>

**Unmitigated Construction Off-Site**

Category	ROG	NOx	CO	SO2	Fugitive PM10	Exhaust PM10	PM10 Total	Fugitive PM2.5	Exhaust PM2.5	PM2.5 Total	Blb- CO2	NBlb- CO2	Total CO2	CH4	N2O	CO2e
	lb/day															
Hauling	0.0000	0.0000	0.0000	0.0000	0.0000	0.0000	0.0000	0.0000	0.0000	0.0000			0.0000	0.0000		0.0000
Vendor	0.0000	0.0000	0.0000	0.0000	0.0000	0.0000	0.0000	0.0000	0.0000	0.0000			0.0000	0.0000		0.0000
Worker	0.4034	0.1620	2.4626	5.0600e-003	107.9399	2.7500e-003	107.9426	10.8560	2.5400e-003	10.8565		521.7670	521.7670	0.0180	0.0160	526.9750
<b>Total</b>	<b>0.4034</b>	<b>0.1620</b>	<b>2.4626</b>	<b>5.0600e-003</b>	<b>107.9399</b>	<b>2.7500e-003</b>	<b>107.9426</b>	<b>10.8560</b>	<b>2.5400e-003</b>	<b>10.8565</b>		<b>521.7670</b>	<b>521.7670</b>	<b>0.0180</b>	<b>0.0160</b>	<b>526.9750</b>

EEC ORIGINAL PKG



Green Valley Logistics (Imperial County) - Imperial County, Summer

**EMFAC Off-Model Adjustment Factors for Gasoline Light Duty Vehicle to Account for the SAFE Vehicle Rule Applied**

**3.6 Architectural Coating - 2024**

**Mitigated Construction On-Site**

Category	ROG	NOx	CO	SO2	Fugitive PM10	Exhaust PM10	PM10 Total	Fugitive PM2.5	Exhaust PM2.5	PM2.5 Total	Bio- CO2	NBio- CO2	Total CO2	CH4	N2O	CO2e
lb/day																
Archit. Coating	65.2891					0.0000	0.0000		0.0000	0.0000			0.0000			0.0000
Off-Road	0.0594	1.3570	1.8324	2.9700e-003		0.0143	0.0143		0.0143	0.0143	0.0000	281.4481	281.4481 + 281.4481	0.0159		281.8443
<b>Total</b>	<b>65.3486</b>	<b>1.3570</b>	<b>1.8324</b>	<b>2.9700e-003</b>		<b>0.0143</b>	<b>0.0143</b>		<b>0.0143</b>	<b>0.0143</b>	<b>0.0000</b>	<b>281.4481</b>	<b>281.4481</b>	<b>0.0159</b>		<b>281.8443</b>

**Mitigated Construction Off-Site**

Category	ROG	NOx	CO	SO2	Fugitive PM10	Exhaust PM10	PM10 Total	Fugitive PM2.5	Exhaust PM2.5	PM2.5 Total	Bio- CO2	NBio- CO2	Total CO2	CH4	N2O	CO2e
lb/day																
Hauling	0.0000	0.0000	0.0000	0.0000	0.0000	0.0000	0.0000	0.0000	0.0000	0.0000			0.0000	0.0000		0.0000
Vendor	0.0000	0.0000	0.0000	0.0000	0.0000	0.0000	0.0000	0.0000	0.0000	0.0000			0.0000	0.0000		0.0000
Worker	0.4034	0.1620	2.4626	5.0600e-003	107.9399	2.7500e-003	107.9426	10.8560	2.5400e-003	10.8565			521.7670 + 521.7670	0.0180	0.0160	526.9750
<b>Total</b>	<b>0.4034</b>	<b>0.1620</b>	<b>2.4626</b>	<b>5.0600e-003</b>	<b>107.9399</b>	<b>2.7500e-003</b>	<b>107.9426</b>	<b>10.8560</b>	<b>2.5400e-003</b>	<b>10.8565</b>			<b>521.7670</b>	<b>0.0180</b>	<b>0.0160</b>	<b>526.9750</b>

REC ORIGINAL PKG

Green Valley Logistics (Imperial County) - Imperial County, Summer

**EMFAC Off-Model Adjustment Factors for Gasoline Light Duty Vehicle to Account for the SAFE Vehicle Rule Applied**

**3.6 Architectural Coating - 2025**

**Unmitigated Construction On-Site**

Category	ROG	NOx	CO	SO2	Fugitive PM10	Exhaust PM10	PM10 Total	Fugitive PM2.5	Exhaust PM2.5	PM2.5 Total	Bio- CO2	NBio- CO2	Total CO2	CH4	N2O	CO2e
lb/day																
Archit. Coating	65.2891					0.0000	0.0000		0.0000	0.0000			0.0000			0.0000
Off-Road	0.1709	1.1455	1.8091	2.9700e-003		0.0515	0.0515		0.0515	0.0515			281.4481	0.0154		281.8319
<b>Total</b>	<b>65.4600</b>	<b>1.1455</b>	<b>1.8091</b>	<b>2.9700e-003</b>		<b>0.0515</b>	<b>0.0515</b>		<b>0.0515</b>	<b>0.0515</b>			<b>281.4481</b>	<b>0.0154</b>		<b>281.8319</b>

**Unmitigated Construction Off-Site**

Category	ROG	NOx	CO	SO2	Fugitive PM10	Exhaust PM10	PM10 Total	Fugitive PM2.5	Exhaust PM2.5	PM2.5 Total	Bio- CO2	NBio- CO2	Total CO2	CH4	N2O	CO2e
lb/day																
Leaving	0.0000	0.0000	0.0000	0.0000		0.0000	0.0000		0.0000	0.0000			0.0000			0.0000
Vendor	0.0000	0.0000	0.0000	0.0000		0.0000	0.0000		0.0000	0.0000			0.0000			0.0000
Worker	0.3747	0.1452	2.2767	4.8800e-003	107.9399	2.6000e-003	107.9425	10.8560	2.3900e-003	10.8564			508.8549	0.0162	0.0149	513.6677
<b>Total</b>	<b>0.3747</b>	<b>0.1452</b>	<b>2.2767</b>	<b>4.8800e-003</b>	<b>107.9399</b>	<b>2.6000e-003</b>	<b>107.9425</b>	<b>10.8560</b>	<b>2.3900e-003</b>	<b>10.8564</b>			<b>508.8549</b>	<b>0.0162</b>	<b>0.0149</b>	<b>513.6677</b>

REC ORIGINAL PKG

Green Valley Logistics (Imperial County) - Imperial County, Summer

**EMFAC Off-Model Adjustment Factors for Gasoline Light Duty Vehicle to Account for the SAFE Vehicle Rule Applied**

**3.6 Architectural Coating - 2025**

**Mitigated Construction On-Site**

Category	ROG	NOx	CO	SO2	Fugitive PM10	Exhaust PM10	PM10 Total	Fugitive PM2.5	Exhaust PM2.5	PM2.5 Total	Bio- CO2	NBio- CO2	Total CO2	CH4	N2O	CO2e
lb/day																
Archit. Coating	65.2891					0.0000	0.0000		0.0000	0.0000			0.0000			0.0000
Off-Road	0.0594	1.3570	1.8324	2.9700e-003		0.0143	0.0143		0.0143	0.0143	0.0000	281.4481	281.4481	0.0154		281.8319
<b>Total</b>	<b>65.3486</b>	<b>1.3570</b>	<b>1.8324</b>	<b>2.9700e-003</b>		<b>0.0143</b>	<b>0.0143</b>		<b>0.0143</b>	<b>0.0143</b>	<b>0.0000</b>	<b>281.4481</b>	<b>281.4481</b>	<b>0.0154</b>		<b>281.8319</b>

**Mitigated Construction Off-Site**

Category	ROG	NOx	CO	SO2	Fugitive PM10	Exhaust PM10	PM10 Total	Fugitive PM2.5	Exhaust PM2.5	PM2.5 Total	Bio- CO2	NBio- CO2	Total CO2	CH4	N2O	CO2e
lb/day																
Trucking	0.0000	0.0000	0.0000	0.0000	0.0000	0.0000	0.0000	0.0000	0.0000	0.0000			0.0000	0.0000	0.0000	0.0000
Vendor	0.0000	0.0000	0.0000	0.0000	0.0000	0.0000	0.0000	0.0000	0.0000	0.0000			0.0000	0.0000	0.0000	0.0000
Worker	0.3747	0.1452	2.2767	4.8800e-003	107.9399	2.6000e-003	107.9425	10.8560	2.3900e-003	10.8584			508.8549	0.0162	0.0149	513.6877
<b>Total</b>	<b>0.3747</b>	<b>0.1452</b>	<b>2.2767</b>	<b>4.8800e-003</b>	<b>107.9399</b>	<b>2.6000e-003</b>	<b>107.9425</b>	<b>10.8560</b>	<b>2.3900e-003</b>	<b>10.8584</b>			<b>508.8549</b>	<b>0.0162</b>	<b>0.0149</b>	<b>513.6877</b>

EEO ORIGINAL PKG

Green Valley Logistics (Imperial County) - Imperial County, Summer

**EMFAC Off-Model Adjustment Factors for Gasoline Light Duty Vehicle to Account for the SAFE Vehicle Rule Applied**

**4.0 Operational Detail - Mobile**

**4.1 Mitigation Measures Mobile**

Category	lb/day															
	ROG	NOx	CO	SO2	Fugitive PM10	Exhaust PM10	PM10 Total	Fugitive PM2.5	Exhaust PM2.5	PM2.5 Total	Bio- CO2	NBio- CO2	Total CO2	CH4	N2O	CO2e
Mitigated	0.0341	0.0165	0.3225	8.4000e-004	10.5142	4.3000e-004	10.5146	1.0632	4.0000e-004	1.0636	87.1296	87.1296	87.1296	2.3000e-003	2.3000e-003	87.8724
Unmitigated	0.0341	0.0165	0.3225	8.4000e-004	10.5142	4.3000e-004	10.5146	1.0632	4.0000e-004	1.0636	87.1296	87.1296	87.1296	2.3000e-003	2.3000e-003	87.8724

**4.2 Trip Summary Information**

Land Use	Average Daily Trip Rate			Unmitigated		Mitigated	
	Weekday	Saturday	Sunday	Annual VMT	Annual VMT	Annual VMT	Annual VMT
Convenience Market with Gas Pumps	0.00	0.00	0.00	50,947	50,947	50,947	50,947
General Heavy Industry	21.50	21.50	21.50	50,947	50,947	50,947	50,947
Parking Lot	0.00	0.00	0.00				
Unrefrigerated Warehouse-Rail	0.00	0.00	0.00				
<b>Total</b>	<b>21.50</b>	<b>21.50</b>	<b>21.50</b>	<b>50,947</b>	<b>50,947</b>	<b>50,947</b>	<b>50,947</b>

**4.3 Trip Type Information**

Land Use	Miles				Trip %				Trip Purpose %				
	H-W or C-W	H-S or C-C	H-O or C-NW	H-W or C-W	H-S or C-C	H-O or C-NW	H-W or C-W	H-S or C-C	H-O or C-NW	Primary	Diverted	Pass-by	Pass-by
Convenience Market with Gas	6.70	5.00	8.90	0.80	80.20	19.00	0.80	80.20	19.00	0	0	0	0
General Heavy Industry	6.70	5.00	8.90	59.00	28.00	13.00	59.00	28.00	13.00	100	0	0	0
Parking Lot	6.70	5.00	8.90	0.00	0.00	0.00	0.00	0.00	0.00	0	0	0	0



Green Valley Logistics (Imperial County) - Imperial County, Summer

**EMFAC Off-Model Adjustment Factors for Gasoline Light Duty Vehicle to Account for the SAFE Vehicle Rule Applied**

Land Use	Miles				Trip %				Trip Purpose %			
	H-W or C-W	H-S or C-C	H-O or C-NW	H-W or C-W	H-S or C-C	H-O or C-NW	H-W or C-W	H-S or C-C	H-O or C-NW	Primary	Diverted	Pass-by
Unrefrigerated Warehouse-Rail	6.70	5.00	8.90	59.00	0.00	41.00	0	0	0	0	0	0

**4.4 Fleet Mix**

Land Use	LDA	LDT1	LDT2	MDV	LHD1	LHD2	MHD	HHD	OBUS	UBUS	MCY	SBUS	MH
Convenience Market with Gas Pumps	0.530702	0.059328	0.179664	0.144474	0.026250	0.006790	0.008325	0.016302	0.000941	0.000118	0.022966	0.000752	0.0003388
General Heavy Industry	1.000000	0.000000	0.000000	0.000000	0.000000	0.000000	0.000000	0.000000	0.000000	0.000000	0.000000	0.000000	0.000000
Parking Lot	0.530702	0.059328	0.179664	0.144474	0.026250	0.006790	0.008325	0.016302	0.000941	0.000118	0.022966	0.000752	0.0003388
Unrefrigerated Warehouse-Rail	0.530702	0.059328	0.179664	0.144474	0.026250	0.006790	0.008325	0.016302	0.000941	0.000118	0.022966	0.000752	0.0003388

**5.0 Energy Detail**

Historical Energy Use: N

**5.1 Mitigation Measures Energy**

EFC ORIGINAL PKG

Category	ROG	NOx	CO	SO2	Fugitive PM10	Exhaust PM10	PM10 Total	Fugitive PM2.5	Exhaust PM2.5	PM2.5 Total	Bio- CO2	NBio- CO2	Total CO2	CH4	N2O	CO2e
Natural Gas Mitigated	0.1073	0.9754	0.8194	5.8500e-003	0.0741	0.0741	0.0741	0.0741	0.0741	0.0741	1,170.4978	1,170.4978	1,170.4978	0.0224	0.0215	1,177.4535
Natural Gas Unmitigated	0.1073	0.9754	0.8194	5.8500e-003	0.0741	0.0741	0.0741	0.0741	0.0741	0.0741	1,170.4978	1,170.4978	1,170.4978	0.0224	0.0215	1,177.4535



Green Valley Logistics (Imperial County) - Imperial County, Summer

**EMFAC Off-Model Adjustment Factors for Gasoline Light Duty Vehicle to Account for the SAFE Vehicle Rule Applied**

**5.2 Energy by Land Use - NaturalGas**

**Unmitigated**

Land Use	NaturalGas Use kBtu/yr	lb/day										CO2e					
		ROG	NOx	CO	SO2	Fugitive PM10	Exhaust PM10	PM10 Total	Fugitive PM2.5	Exhaust PM2.5	PM2.5 Total		Bio- CO2	NBio- CO2	Total CO2	CH4	N2O
Convenience Market with Gas Pumps	13.6147	1.5000e-004	1.3300e-003	1.1200e-003	1.0000e-005	1.0000e-004	1.0000e-004	1.0000e-004	1.0000e-004	1.0000e-004	1.0000e-004	0.0000	0.0000	1.6017	3.0000e-005	3.0000e-005	1.6113
General Heavy Industry	4428.77	0.0478	0.4342	0.3647	2.6100e-003	0.0330	0.0330	0.0330	0.0330	0.0330	0.0330	0.0000	0.0000	521.0314	9.9900e-003	9.5500e-003	524.1277
Parking Lot	0	0.0000	0.0000	0.0000	0.0000	0.0000	0.0000	0.0000	0.0000	0.0000	0.0000	0.0000	0.0000	0.0000	0.0000	0.0000	0.0000
Unrefrigerated Warehouse-Rail	5506.85	0.0594	0.5399	0.4535	3.2400e-003	0.0410	0.0410	0.0410	0.0410	0.0410	0.0410	0.0000	0.0000	647.8646	0.0124	0.0119	651.7146
<b>Total</b>		<b>0.1073</b>	<b>0.9754</b>	<b>0.8194</b>	<b>5.8600e-003</b>	<b>0.0741</b>	<b>0.0741</b>	<b>0.0741</b>	<b>0.0741</b>	<b>0.0741</b>	<b>0.0741</b>	<b>1,170.4978</b>	<b>1,170.4978</b>	<b>1,170.4978</b>	<b>0.0224</b>	<b>0.0215</b>	<b>1,177.4535</b>

Green Valley Logistics (Imperial County) - Imperial County, Summer

**EMFAC Off-Model Adjustment Factors for Gasoline Light Duty Vehicle to Account for the SAFE Vehicle Rule Applied**

**5.2 Energy by Land Use - NaturalGas**

**Mitigated**

Land Use	NaturalGas Use kBTU/yr	ROG	NOx	CO	SO2	PM10			PM2.5 Total	Bio- CO2	NBio- CO2	Total CO2	CH4	N2O	CO2e
						Fugitive PM10	Exhaust PM10	PM10 Total							
Convenience Marketwith Gas Pumps	0.0136147	1.5000e-004	1.3300e-003	1.1200e-003	1.0000e-005	1.0000e-004	1.0000e-004	1.0000e-004	1.0000e-004	1.8017	1.8017	1.8017	3.0000e-005	3.0000e-005	1.6113
General Heavy Industry	4.42877	0.0478	0.4342	0.3647	2.6100e-003	0.0330	0.0330	0.0330	0.0330	521.0314	521.0314	521.0314	9.9900e-003	9.9900e-003	524.1277
Parking Lot	0	0.0000	0.0000	0.0000	0.0000	0.0000	0.0000	0.0000	0.0000	0.0000	0.0000	0.0000	0.0000	0.0000	0.0000
Unrefrigerated Warehouse-Rail	5.50685	0.0594	0.5399	0.4535	3.2400e-003	0.0410	0.0410	0.0410	0.0410	647.8646	647.8646	647.8646	0.0124	0.0119	651.7146
<b>Total</b>		<b>0.1073</b>	<b>0.9754</b>	<b>0.8194</b>	<b>5.8600e-003</b>	<b>0.0741</b>	<b>0.0741</b>	<b>0.0741</b>	<b>0.0741</b>	<b>1,170.4978</b>	<b>1,170.4978</b>	<b>1,170.4978</b>	<b>0.0224</b>	<b>0.0215</b>	<b>1,177.4635</b>

**6.0 Area Detail**

**6.1 Mitigation Measures Area**

ORIGINAL PKG

Green Valley Logistics (Imperial County) - Imperial County, Summer

**EMFAC Off-Model Adjustment Factors for Gasoline Light Duty Vehicle to Account for the SAFE Vehicle Rule Applied**

Category	ROG	NOx	CO	SO2	Fugitive PM10	Exhaust PM10	PM10 Total	Fugitive PM2.5	Exhaust PM2.5	PM2.5 Total	Bio- CO2	NBio- CO2	Total CO2	CH4	N2O	CO2e
lb/day																
Mitigated	26.6059	1.3100e-003	0.1442	1.0000e-005	5.1000e-004	5.1000e-004	5.1000e-004	5.1000e-004	5.1000e-004	5.1000e-004		0.3099	0.3099	8.1000e-004		0.3301
Unmitigated	26.6059	1.3100e-003	0.1442	1.0000e-005	5.1000e-004	5.1000e-004	5.1000e-004	5.1000e-004	5.1000e-004	5.1000e-004		0.3099	0.3099	8.1000e-004		0.3301

**6.2 Area by SubCategory**

Unmitigated

SubCategory	ROG	NOx	CO	SO2	Fugitive PM10	Exhaust PM10	PM10 Total	Fugitive PM2.5	Exhaust PM2.5	PM2.5 Total	Bio- CO2	NBio- CO2	Total CO2	CH4	N2O	CO2e
lb/day																
Architectural Coating	4.0247				0.0000	0.0000	0.0000	0.0000	0.0000	0.0000			0.0000			0.0000
Consumer Products	22.5679				0.0000	0.0000	0.0000	0.0000	0.0000	0.0000			0.0000			0.0000
Landscaping	0.0133	1.3100e-003	0.1442	1.0000e-005	5.1000e-004	5.1000e-004	5.1000e-004	5.1000e-004	5.1000e-004	5.1000e-004		0.3099	0.3099	8.1000e-004		0.3301
<b>Total</b>	<b>26.6059</b>	<b>1.3100e-003</b>	<b>0.1442</b>	<b>1.0000e-005</b>	<b>5.1000e-004</b>	<b>5.1000e-004</b>	<b>5.1000e-004</b>	<b>5.1000e-004</b>	<b>5.1000e-004</b>	<b>5.1000e-004</b>		<b>0.3099</b>	<b>0.3099</b>	<b>8.1000e-004</b>		<b>0.3301</b>

TEC ORIGINAL PKG

Green Valley Logistics (Imperial County) - Imperial County, Summer

**EMFAC Off-Model Adjustment Factors for Gasoline Light Duty Vehicle to Account for the SAFE Vehicle Rule Applied**

**6.2 Area by SubCategory**

**Mitigated**

SubCategory	ROG	NOx	CO	SO2	Fugitive PM10	Exhaust PM10	PM10 Total	Fugitive PM2.5	Exhaust PM2.5	PM2.5 Total	Bio- CO2	NBio- CO2	Total CO2	CH4	N2O	CO2e
	lb/day															
Architectural Coating	4.0247					0.0000	0.0000		0.0000	0.0000			0.0000			0.0000
Consumer Products	22.5679					0.0000	0.0000		0.0000	0.0000			0.0000			0.0000
Landscaping	0.0133	1.3100e-003	0.1442	1.0000e-005		5.1000e-004	5.1000e-004		5.1000e-004	5.1000e-004		0.3099	0.3099	8.1000e-004		0.3301
<b>Total</b>	<b>26.6059</b>	<b>1.3100e-003</b>	<b>0.1442</b>	<b>1.0000e-005</b>		<b>5.1000e-004</b>	<b>5.1000e-004</b>		<b>5.1000e-004</b>	<b>5.1000e-004</b>		<b>0.3099</b>	<b>0.3099</b>	<b>8.1000e-004</b>		<b>0.3301</b>

**7.0 Water Detail**

**7.1 Mitigation Measures Water**

**EEC ORIGINAL PKG**

Green Valley Logistics (Imperial County) - Imperial County, Summer

**EMFAC Off-Model Adjustment Factors for Gasoline Light Duty Vehicle to Account for the SAFE Vehicle Rule Applied**

**8.0 Waste Detail**

**8.1 Mitigation Measures Waste**

**9.0 Operational Offroad**

Equipment Type	Number	Hours/Day	Days/Year	Horse Power	Load Factor	Fuel Type
----------------	--------	-----------	-----------	-------------	-------------	-----------

**10.0 Stationary Equipment**

**Fire Pumps and Emergency Generators**

Equipment Type	Number	Hours/Day	Hours/Year	Horse Power	Load Factor	Fuel Type
----------------	--------	-----------	------------	-------------	-------------	-----------

**Boilers**

Equipment Type	Number	Heat Input/Day	Heat Input/Year	Boiler Rating	Fuel Type
----------------	--------	----------------	-----------------	---------------	-----------

**User Defined Equipment**

Equipment Type	Number
----------------	--------

**11.0 Vegetation**



Green Valley Logistics (Imperial County) - Imperial County, Winter

**EMFAC Off-Model Adjustment Factors for Gasoline Light Duty Vehicle to Account for the SAFE Vehicle Rule Applied**

**Green Valley Logistics (Imperial County)**

Imperial County, Winter

**1.0 Project Characteristics**

**1.1 Land Usage**

Land Uses	Size	Metric	Lot Acreage	Floor Surface Area	Population
General Heavy Industry	50.00	1000sqft	207.00	50,000.00	0
Unrefrigerated Warehouse-Rail	1,000.00	1000sqft	64.00	1,000,000.00	0
Parking Lot	350.00	Space	4.00	140,000.00	0
Convenience Market with Gas Pumps	16.00	Pump	9.50	2,258.80	0

**1.2 Other Project Characteristics**

Urbanization	Urban	Wind Speed (m/s)	3.4	Precipitation Freq (Days)	12
Climate Zone	15			Operational Year	2025

Utility Company Imperial Irrigation District

CO2 Intensity (lb/MW/hr)	189.98	CH4 Intensity (lb/MW/hr)	0.033	N2O Intensity (lb/MW/hr)	0.004
--------------------------	--------	--------------------------	-------	--------------------------	-------

**1.3 User Entered Comments & Non-Default Data**

Project Characteristics -

Land Use - 284.5 acres site

Construction Phase - Construction Schedule

Offroad Equipment - CE

Trips and VMT - Project would use 24,250 trucks to deliver 24CY of stone material per truck during Grading and Building Construction. Per Mitigation Measure AQMM-1... all haul routes and worker trips to and from the site shall be 100% paved.

Onroad Fugitive Dust - The Project assumes 90% paved.

Grading - 1,000 CY of export grubbed material

Architectural Coating -







Green Valley Logistics (Imperial County) - Imperial County, Winter

**EMFAC Off-Model Adjustment Factors for Gasoline Light Duty Vehicle to Account for the SAFE Vehicle Rule Applied**

tblFleetMix	MCY	0.02	0.00
tblFleetMix	MDV	0.14	0.00
tblFleetMix	MH	3.3880e-003	0.00
tblFleetMix	MHD	8.3250e-003	0.00
tblFleetMix	OBUS	9.4100e-004	0.00
tblFleetMix	SBUS	7.5200e-004	0.00
tblFleetMix	UBUS	1.1800e-004	0.00
tblGrading	MaterialExported	0.00	1,000.00
tblLandUse	LotAcreage	1.15	207.00
tblLandUse	LotAcreage	22.96	64.00
tblLandUse	LotAcreage	3.15	4.00
tblLandUse	LotAcreage	0.05	9.50
tblOffRoadEquipment	OffRoadEquipmentUnitAmount	1.00	2.00
tblOnRoadDust	HaulingPercentPave	50.00	90.00
tblOnRoadDust	HaulingPercentPave	50.00	90.00
tblOnRoadDust	HaulingPercentPave	50.00	90.00
tblOnRoadDust	HaulingPercentPave	50.00	90.00
tblOnRoadDust	HaulingPercentPave	50.00	90.00
tblOnRoadDust	VendorPercentPave	50.00	90.00
tblOnRoadDust	VendorPercentPave	50.00	90.00
tblOnRoadDust	VendorPercentPave	50.00	90.00
tblOnRoadDust	VendorPercentPave	50.00	90.00
tblOnRoadDust	WorkerPercentPave	50.00	90.00
tblOnRoadDust	WorkerPercentPave	50.00	90.00
tblOnRoadDust	WorkerPercentPave	50.00	90.00
tblOnRoadDust	WorkerPercentPave	50.00	90.00
tblOnRoadDust	WorkerPercentPave	50.00	90.00
tblOnRoadDust	RoadPercentPave	50	90

**FEC ORIGINAL PKG**

Green Valley Logistics (Imperial County) - Imperial County, Winter

**EMFAC Off-Model Adjustment Factors for Gasoline Light Duty Vehicle to Account for the SAFE Vehicle Rule Applied**

tbSolidWaste	SolidWasteGenerationRate	940.00	188.00
tbTripsAndVMT	Hauling TripNumber	0.00	2,965.35
tbTripsAndVMT	Hauling TripNumber	0.00	21,284.65
tbVehicleTrips	DV_TP	21.00	0.00
tbVehicleTrips	DV_TP	5.00	0.00
tbVehicleTrips	DV_TP	5.00	0.00
tbVehicleTrips	PB_TP	65.00	0.00
tbVehicleTrips	PB_TP	3.00	0.00
tbVehicleTrips	PB_TP	3.00	0.00
tbVehicleTrips	PR_TP	14.00	0.00
tbVehicleTrips	PR_TP	92.00	100.00
tbVehicleTrips	PR_TP	92.00	0.00
tbVehicleTrips	ST_TR	322.50	0.00
tbVehicleTrips	ST_TR	6.42	0.43
tbVehicleTrips	ST_TR	1.74	0.00
tbVehicleTrips	SU_TR	322.50	0.00
tbVehicleTrips	SU_TR	5.09	0.43
tbVehicleTrips	SU_TR	1.74	0.00
tbVehicleTrips	WD_TR	322.50	0.00
tbVehicleTrips	WD_TR	3.93	0.43
tbVehicleTrips	WD_TR	1.74	0.00
tbWater	IndoorWaterUseRate	167,314.87	0.00
tbWater	IndoorWaterUseRate	11,562,500.00	0.00
tbWater	IndoorWaterUseRate	231,250,000.00	12,000,000.00
tbWater	OutdoorWaterUseRate	102,547.82	0.00
tbWater	OutdoorWaterUseRate	0.00	46,650,000.00

FEC ORIGINAL PKG

**2.0 Emissions Summary**



Green Valley Logistics (Imperial County) - Imperial County, Winter

**EMFAC Off-Model Adjustment Factors for Gasoline Light Duty Vehicle to Account for the SAFE Vehicle Rule Applied**

**2.1 Overall Construction (Maximum Daily Emission)**

Unmitigated Construction

Year	lb/day															
	ROG	NOx	CO	SO2	Fugitive PM10	Exhaust PM10	PM10 Total	Fugitive PM2.5	Exhaust PM2.5	PM2.5 Total	Bio- CO2	NBio- CO2	Total CO2	CH4	N2O	CO2e
2024	69.1983	66.8738	48.7807	0.1553	1,100.651	2.6495	1,101.458	110.8170	2.4406	111.5741	0.0000	15,819.73	15,819.73	3.1541	1.3202	16,252.93
					1		5			86						89
2025	68.9650	30.9630	34.8557	0.1367	1,100.651	0.7271	1,101.378	110.8170	0.6819	111.4989	0.0000	14,041.19	14,041.19	1.0618	1.2848	14,450.61
					1		2			63						57
Maximum	69.1983	66.8738	48.7807	0.1553	1,100.651	2.6495	1,101.458	110.8170	2.4406	111.5741	0.0000	15,819.73	15,819.73	3.1541	1.3202	16,252.93
					1		5			86						89

Mitigated Construction

Year	lb/day															
	ROG	NOx	CO	SO2	Fugitive PM10	Exhaust PM10	PM10 Total	Fugitive PM2.5	Exhaust PM2.5	PM2.5 Total	Bio- CO2	NBio- CO2	Total CO2	CH4	N2O	CO2e
2024	68.4141	56.3647	62.4049	0.1553	1,100.651	0.4215	1,100.985	110.8170	0.4178	111.1432	0.0000	15,819.73	15,819.73	3.1541	1.3202	16,252.93
					1		2			86						89
2025	68.2829	33.9681	38.3726	0.1367	1,100.651	0.3323	1,100.983	110.8170	0.3245	111.1415	0.0000	14,041.19	14,041.19	1.0618	1.2848	14,450.61
					1		4			63						57
Maximum	68.4141	56.3647	62.4049	0.1553	1,100.651	0.4215	1,100.985	110.8170	0.4178	111.1432	0.0000	15,819.73	15,819.73	3.1541	1.3202	16,252.93
					1		2			86						89

EEC ORIGINAL PKG

Green Valley Logistics (Imperial County) - Imperial County, Winter

**EMFAC Off-Model Adjustment Factors for Gasoline Light Duty Vehicle to Account for the SAFE Vehicle Rule Applied**

	ROG	NOx	CO	SO2	Fugitive PM10	Exhaust PM10	PM10 Total	Fugitive PM2.5	Exhaust PM2.5	PM2.5 Total	Bio- CO2	NBio-CO2	Total CO2	CH4	N2O	CO2e
Percent Reduction	1.06	7.67	-20.49	0.00	0.00	77.67	0.04	0.00	76.23	0.35	0.00	0.00	0.00	0.00	0.00	0.00

Green Valley Logistics (Imperial County) - Imperial County, Winter

**EMFAC Off-Model Adjustment Factors for Gasoline Light Duty Vehicle to Account for the SAFE Vehicle Rule Applied**

**2.2 Overall Operational  
Unmitigated Operational**

Category	ROG	NOx	CO	SO2	Fugitive PM10	Exhaust PM10	PM10 Total	Fugitive PM2.5	Exhaust PM2.5	PM2.5 Total	Bio- CO2	NBio- CO2	Total CO2	CH4	N2O	CO2e
lb/day																
Area	26.6059	1.3100e-003	0.1442	1.0000e-005	5.1000e-004	5.1000e-004	5.1000e-004	5.1000e-004	5.1000e-004	5.1000e-004	0.3099	0.3099	0.3099	8.1000e-004	0.0215	0.3301
Energy	0.1073	0.9754	0.8194	5.8500e-003	0.0741	0.0741	0.0741	0.0741	0.0741	0.0741	1,170.4978	1,170.4978	1,170.4978	0.0224	0.0215	1,177.4535
Mobile	0.0206	0.0168	0.2477	7.0000e-004	10.5142	4.3000e-004	10.5146	1.0632	4.0000e-004	1.0636	73.0773	73.0773	73.0773	2.5500e-003	2.3200e-003	73.8317
<b>Total</b>	<b>26.7338</b>	<b>0.9935</b>	<b>1.2113</b>	<b>6.5600e-003</b>	<b>10.5142</b>	<b>0.0751</b>	<b>10.5892</b>	<b>1.0632</b>	<b>0.0750</b>	<b>1.1383</b>	<b>1,243.8850</b>	<b>1,243.8850</b>	<b>1,243.8850</b>	<b>0.0258</b>	<b>0.0238</b>	<b>1,251.6152</b>

**Mitigated Operational**

Category	ROG	NOx	CO	SO2	Fugitive PM10	Exhaust PM10	PM10 Total	Fugitive PM2.5	Exhaust PM2.5	PM2.5 Total	Bio- CO2	NBio- CO2	Total CO2	CH4	N2O	CO2e
lb/day																
Area	26.6059	1.3100e-003	0.1442	1.0000e-005	5.1000e-004	5.1000e-004	5.1000e-004	5.1000e-004	5.1000e-004	5.1000e-004	0.3099	0.3099	0.3099	8.1000e-004	0.0215	0.3301
Energy	0.1073	0.9754	0.8194	5.8500e-003	0.0741	0.0741	0.0741	0.0741	0.0741	0.0741	1,170.4978	1,170.4978	1,170.4978	0.0224	0.0215	1,177.4535
Mobile	0.0206	0.0168	0.2477	7.0000e-004	10.5142	4.3000e-004	10.5146	1.0632	4.0000e-004	1.0636	73.0773	73.0773	73.0773	2.5500e-003	2.3200e-003	73.8317
<b>Total</b>	<b>26.7338</b>	<b>0.9935</b>	<b>1.2113</b>	<b>6.5600e-003</b>	<b>10.5142</b>	<b>0.0751</b>	<b>10.5892</b>	<b>1.0632</b>	<b>0.0750</b>	<b>1.1383</b>	<b>1,243.8850</b>	<b>1,243.8850</b>	<b>1,243.8850</b>	<b>0.0258</b>	<b>0.0238</b>	<b>1,251.6152</b>

EFC ORIGINAL PKG

Green Valley Logistics (Imperial County) - Imperial County, Winter

**EMFAC Off-Model Adjustment Factors for Gasoline Light Duty Vehicle to Account for the SAFE Vehicle Rule Applied**

ROG	NOx	CO	SO2	Fugitive PM10	Exhaust PM10	PM10 Total	Fugitive PM2.5	Exhaust PM2.5	PM2.5 Total	Bio- CO2	NBio-CO2	Total CO2	CH4	N2O	CO2e
0.00	0.00	0.00	0.00	0.00	0.00	0.00	0.00	0.00	0.00	0.00	0.00	0.00	0.00	0.00	0.00

**3.0 Construction Detail**

**Construction Phase**

Phase Number	Phase Name	Phase Type	Start Date	End Date	Num Days Week	Num Days	Phase Description
1	Site Preparation	Site Preparation	1/1/2024	3/1/2024	5	45	
2	Grading	Grading	2/1/2024	4/3/2024	5	45	
3	Building Construction	Building Construction	4/4/2024	6/30/2025	5	323	
4	Paving	Paving	4/4/2024	5/8/2024	5	25	
5	Architectural Coating	Architectural Coating	7/1/2024	5/9/2025	5	225	

**Acres of Grading (Site Preparation Phase): 67.5**

**Acres of Grading (Grading Phase): 135**

**Acres of Paving: 4**

**Residential Indoor: 0; Residential Outdoor: 0; Non-Residential Indoor: 1,578,388; Non-Residential Outdoor: 526,129; Striped Parking Area: 8,400 (Architectural Coating – sqft)**

**Offroad Equipment**

Phase Name	Offroad Equipment Type	Amount	Usage Hours	Horse Power	Load Factor
Site Preparation	Rubber Tired Dozers	3	8.00	247	0.40
Site Preparation	Tractors/Loaders/Backhoes	4	8.00	97	0.37
Grading	Excavators	2	8.00	158	0.38
Grading	Graders	1	8.00	187	0.41
Grading	Rubber Tired Dozers	1	8.00	247	0.40
Grading	Scrapers	2	8.00	367	0.48

Green Valley Logistics (Imperial County) - Imperial County, Winter

**EMFAC Off-Model Adjustment Factors for Gasoline Light Duty Vehicle to Account for the SAFE Vehicle Rule Applied**

Phase Name	Offroad Equipment Count	Tractors/Loaders/Backhoes	Vendor Trip Number	Worker Trip Number	Hauling Trip Number	Worker Trip Length	Vendor Trip Length	Hauling Trip Length	Worker Vehicle Class	Vendor Vehicle Class	Hauling Vehicle Class
Grading		2	2	97	8.00	97	0.37				
Building Construction		2	2	63	8.00	63	0.31				
Building Construction		2	2	231	7.00	231	0.29				
Building Construction		2	2	100	8.00	100	0.40				
Building Construction		3	3	97	7.00	97	0.37				
Building Construction		1	1	46	8.00	46	0.45				
Paving		2	2	130	8.00	130	0.42				
Paving		2	2	132	8.00	132	0.36				
Paving		2	2	80	8.00	80	0.38				
Architectural Coating		1	1	78	6.00	78	0.48				

**Trips and VMI**

Phase Name	Offroad Equipment Count	Worker Trip Number	Vendor Trip Number	Hauling Trip Number	Worker Trip Length	Vendor Trip Length	Hauling Trip Length	Worker Vehicle Class	Vendor Vehicle Class	Hauling Vehicle Class
Site Preparation	7	18.00	0.00	125.00	7.30	8.90	20.00	LD_Mix	HDT_Mix	HHDT
Grading	8	20.00	0.00	2,965.35	7.30	8.90	20.00	LD_Mix	HDT_Mix	HHDT
Building Construction	10	501.00	195.00	21,284.65	7.30	8.90	20.00	LD_Mix	HDT_Mix	HHDT
Paving	6	15.00	0.00	0.00	7.30	8.90	20.00	LD_Mix	HDT_Mix	HHDT
Architectural Coating	1	100.00	0.00	0.00	7.30	8.90	20.00	LD_Mix	HDT_Mix	HHDT

**3.1 Mitigation Measures Construction**

- Use Cleaner Engines for Construction Equipment
- Use DPF for Construction Equipment
- Water Exposed Area
- Water Unpaved Roads
- Reduce Vehicle Speed on Unpaved Roads



Green Valley Logistics (Imperial County) - Imperial County, Winter

**EMFAC Off-Model Adjustment Factors for Gasoline Light Duty Vehicle to Account for the SAFE Vehicle Rule Applied**

**3.2 Site Preparation - 2024**

**Unmitigated Construction On-Site**

Category	ROG	NOx	CO	SO2	Fugitive PM10	Exhaust PM10	PM10 Total	Fugitive PM2.5	Exhaust PM2.5	PM2.5 Total	Bio- CO2	NBio- CO2	Total CO2	CH4	N2O	CO2e
lb/day																
Fugitive Dust					19.6614	0.0000	19.6614	10.1031	0.0000	10.1031			0.0000			0.0000
Off-Road	2.6609	27.1760	18.3356	0.0381		1.2294	1.2294		1.1310	1.1310		3.688.010	0	1.1928		3,717.829 4
<b>Total</b>	<b>2.6609</b>	<b>27.1760</b>	<b>18.3356</b>	<b>0.0381</b>	<b>19.6614</b>	<b>1.2294</b>	<b>20.8908</b>	<b>10.1031</b>	<b>1.1310</b>	<b>11.2341</b>		<b>3.688.010</b>	<b>0</b>	<b>1.1928</b>		<b>3,717.829</b> <b>4</b>

**Unmitigated Construction Off-Site**

Category	ROG	NOx	CO	SO2	Fugitive PM10	Exhaust PM10	PM10 Total	Fugitive PM2.5	Exhaust PM2.5	PM2.5 Total	Bio- CO2	NBio- CO2	Total CO2	CH4	N2O	CO2e
lb/day																
Hauling	6.0800e-003	0.2935	0.0821	1.4800e-003	8.2210	3.3800e-003	6.2244	0.8283	3.2400e-003	0.8316		156.5280	156.5280	4.2000e-004	0.0246	163.8711
Vendor	0.0000	0.0000	0.0000	0.0000	0.0000	0.0000	0.0000	0.0000	0.0000	0.0000		0.0000	0.0000	0.0000	0.0000	0.0000
Worker	0.0520	0.0303	0.3278	7.8000e-004	19.4292	5.0000e-004	19.4297	1.9541	4.6000e-004	1.9545		79.9650	79.9650	3.4100e-003	2.9300e-003	80.9220
<b>Total</b>	<b>0.0581</b>	<b>0.3238</b>	<b>0.4099</b>	<b>2.2600e-003</b>	<b>27.6502</b>	<b>3.8800e-003</b>	<b>27.6541</b>	<b>2.7824</b>	<b>3.7000e-003</b>	<b>2.7861</b>		<b>236.4930</b>	<b>236.4930</b>	<b>3.8300e-003</b>	<b>0.0275</b>	<b>244.7931</b>

EEC ORIGINAL PKG

Green Valley Logistics (Imperial County) - Imperial County, Winter

**EMFAC Off-Model Adjustment Factors for Gasoline Light Duty Vehicle to Account for the SAFE Vehicle Rule Applied**

**3.2 Site Preparation - 2024**

**Mitigated Construction On-Site**

Category	ROG	NOx	CO	SO2	Fugitive PM10	Exhaust PM10	PM10 Total	Fugitive PM2.5	Exhaust PM2.5	PM2.5 Total	Bio- CO2	NBio- CO2	Total CO2	CH4	N2O	CO2e
lb/day																
Fugitive Dust					8.8477	0.0000	8.8477	4.5464	0.0000	4.5464			0.0000			0.0000
Off-Road	0.9312	19.0656	22.9600	0.0381		0.1419	0.1419	0.1419	0.1419	0.1419	0.0000	3.688.010	3.688.010	1.1928		3,717.829
<b>Total</b>	<b>0.9312</b>	<b>19.0656</b>	<b>22.9600</b>	<b>0.0381</b>	<b>8.8477</b>	<b>0.1419</b>	<b>8.9896</b>	<b>4.5464</b>	<b>0.1419</b>	<b>4.6883</b>	<b>0.0000</b>	<b>3,688.010</b>	<b>3,688.010</b>	<b>1.1928</b>		<b>3,717.829</b>

**Mitigated Construction Off-Site**

Category	ROG	NOx	CO	SO2	Fugitive PM10	Exhaust PM10	PM10 Total	Fugitive PM2.5	Exhaust PM2.5	PM2.5 Total	Bio- CO2	NBio- CO2	Total CO2	CH4	N2O	CO2e
lb/day																
Hauling	6.0800e-003	0.2935	0.0821	1.4800e-003	8.2210	3.3800e-003	8.2244	0.8283	3.2400e-003	0.8316			156.5280	4.2000e-004	0.0246	163.8711
Vendor	0.0000	0.0000	0.0000	0.0000	0.0000	0.0000	0.0000	0.0000	0.0000	0.0000			0.0000	0.0000	0.0000	0.0000
Worker	0.0520	0.0303	0.3278	7.8000e-004	19.4292	5.0000e-004	19.4297	1.9541	4.6000e-004	1.9545			79.9650	3.4100e-003	2.9300e-003	80.9220
<b>Total</b>	<b>0.0581</b>	<b>0.3238</b>	<b>0.4099</b>	<b>2.2600e-003</b>	<b>27.6502</b>	<b>3.8800e-003</b>	<b>27.6541</b>	<b>2.7824</b>	<b>3.7000e-003</b>	<b>2.7861</b>			<b>236.4930</b>	<b>3.8300e-003</b>	<b>0.0275</b>	<b>244.7931</b>

EEC ORIGINAL PKG

Green Valley Logistics (Imperial County) - Imperial County, Winter

**EMFAC Off-Model Adjustment Factors for Gasoline Light Duty Vehicle to Account for the SAFE Vehicle Rule Applied**

**3.3 Grading - 2024**

**Unmitigated Construction On-Site**

Category	ROG	NOx	CO	SO2	Fugitive PM10	Exhaust PM10	PM10 Total	Fugitive PM2.5	Exhaust PM2.5	PM2.5 Total	Bio- CO2	NBio- CO2	Total CO2	CH4	N2O	CO2e
lb/day																
Fugitive Dust					9.2036	0.0000	9.2036	3.6538	0.0000	3.6538			0.0000			0.0000
Off-Road	3.2181	32.3770	27.7228	0.0621	1.3354	1.3354	1.3354	1.2286	1.2286	1.2286		6,009,748	6,009,748	1.9437		6,058,340
<b>Total</b>	<b>3.2181</b>	<b>32.3770</b>	<b>27.7228</b>	<b>0.0621</b>	<b>9.2036</b>	<b>1.3354</b>	<b>10.5390</b>	<b>3.6538</b>	<b>1.2286</b>	<b>4.8823</b>		<b>6,009,748</b>	<b>6,009,748</b>	<b>1.9437</b>		<b>6,058,340</b>

**Unmitigated Construction Off-Site**

Category	ROG	NOx	CO	SO2	Fugitive PM10	Exhaust PM10	PM10 Total	Fugitive PM2.5	Exhaust PM2.5	PM2.5 Total	Bio- CO2	NBio- CO2	Total CO2	CH4	N2O	CO2e
lb/day																
Hauling	0.1444	6.9634	1.9482	0.0351	195.0262	0.0803	195.1065	19.6502	0.0768	19.7270		3,714,096	3,714,096	9.9900e-003	0.5839	3,888,333
Vendor	0.0000	0.0000	0.0000	0.0000	0.0000	0.0000	0.0000	0.0000	0.0000	0.0000		0.0000	0.0000	0.0000	0.0000	0.0000
Worker	0.0578	0.0337	0.3642	8.6000e-004	21.5880	5.5000e-004	21.5885	2.1712	5.1000e-004	2.1717		88.8500	88.8500	3.7900e-003	3.2500e-003	89.9134
<b>Total</b>	<b>0.2021</b>	<b>6.9971</b>	<b>2.3124</b>	<b>0.0359</b>	<b>216.6142</b>	<b>0.0808</b>	<b>216.6950</b>	<b>21.8214</b>	<b>0.0773</b>	<b>21.8987</b>		<b>3,802,946</b>	<b>3,802,946</b>	<b>0.0138</b>	<b>0.5871</b>	<b>3,978,246</b>

FEC ORIGINAL PKG

Green Valley Logistics (Imperial County) - Imperial County, Winter

**EMFAC Off-Model Adjustment Factors for Gasoline Light Duty Vehicle to Account for the SAFE Vehicle Rule Applied**

**3.3 Grading - 2024**

**Mitigated Construction On-Site**

Category	ROG	NOx	CO	SO2	Fugitive PM10	Exhaust PM10	PM10 Total	Fugitive PM2.5	Exhaust PM2.5	PM2.5 Total	Bio- CO2	NBio- CO2	Total CO2	CH4	N2O	CO2e
lb/day																
Fugitive Dust					4.1416	0.0000	4.1416	1.6442	0.0000	1.6442			0.0000			0.0000
Off-Road	1.5231	29.9782	36.7226	0.0621	0.1949	0.1949	0.1949	0.1949	0.1949	0.1949	0.0000	6,009.748 <sub>7</sub>	6,009.748 <sub>7</sub>	1.9437		6,058.340 <sub>5</sub>
<b>Total</b>	<b>1.5231</b>	<b>29.9782</b>	<b>36.7226</b>	<b>0.0621</b>	<b>4.1416</b>	<b>0.1949</b>	<b>4.3365</b>	<b>1.6442</b>	<b>0.1949</b>	<b>1.8391</b>	<b>0.0000</b>	<b>6,009.748<sub>7</sub></b>	<b>6,009.748<sub>7</sub></b>	<b>1.9437</b>		<b>6,058.340<sub>5</sub></b>

**Mitigated Construction Off-Site**

Category	ROG	NOx	CO	SO2	Fugitive PM10	Exhaust PM10	PM10 Total	Fugitive PM2.5	Exhaust PM2.5	PM2.5 Total	Bio- CO2	NBio- CO2	Total CO2	CH4	N2O	CO2e
lb/day																
Hauling	0.1444	6.9634	1.9482	0.0351	195.0262	0.0803	195.1065	19.6502	0.0768	19.7270		3,714.096 <sub>2</sub>	3,714.096 <sub>2</sub>	9.9900e-003	0.5839	3,888.333 <sub>2</sub>
Vendor	0.0000	0.0000	0.0000	0.0000	0.0000	0.0000	0.0000	0.0000	0.0000	0.0000		0.0000	0.0000	0.0000	0.0000	0.0000
Worker	0.0578	0.0337	0.3642	8.6000e-004	21.5880	5.5000e-004	21.5885	2.1712	5.1000e-004	2.1717		88.8500	88.8500	3.7900e-003	3.2500e-003	89.9134
<b>Total</b>	<b>0.2021</b>	<b>6.9971</b>	<b>2.3124</b>	<b>0.0359</b>	<b>216.6142</b>	<b>0.0808</b>	<b>216.6950</b>	<b>21.8214</b>	<b>0.0773</b>	<b>21.8987</b>		<b>3,802.946<sub>2</sub></b>	<b>3,802.946<sub>2</sub></b>	<b>0.0138</b>	<b>0.5871</b>	<b>3,978.246<sub>6</sub></b>

TEC ORIGINAL PKG



Green Valley Logistics (Imperial County) - Imperial County, Winter

**EMFAC Off-Model Adjustment Factors for Gasoline Light Duty Vehicle to Account for the SAFE Vehicle Rule Applied**

**3.4 Building Construction - 2024**

Unmitigated Construction On-Site

Category	ROG	NOx	CO	SO2	Fugitive PM10	Exhaust PM10	PM10 Total	Fugitive PM2.5	Exhaust PM2.5	PM2.5 Total	Bio- CO2	NBio- CO2	Total CO2	CH4	N2O	CO2e
	lb/day															
Off-Road	1.4682	15.0679	17.4016	0.0311		0.5776	0.5776		0.5352	0.5352		2,970.2404	2,970.2404	0.9147		2,993.1081
<b>Total</b>	<b>1.4682</b>	<b>15.0679</b>	<b>17.4016</b>	<b>0.0311</b>		<b>0.5776</b>	<b>0.5776</b>		<b>0.5352</b>	<b>0.5352</b>		<b>2,970.2404</b>	<b>2,970.2404</b>	<b>0.9147</b>		<b>2,993.1081</b>

Unmitigated Construction Off-Site

Category	ROG	NOx	CO	SO2	Fugitive PM10	Exhaust PM10	PM10 Total	Fugitive PM2.5	Exhaust PM2.5	PM2.5 Total	Bio- CO2	NBio- CO2	Total CO2	CH4	N2O	CO2e
	lb/day															
Hauling	0.1443	6.9620	1.9478	0.0351	195.0264	0.0803	195.1066	19.6502	0.0768	19.7270		3,713.3479	3,713.3479	9.9900e-003	0.5837	3,887.5499
Vendor	0.3799	8.1546	3.7503	0.0441	256.9063	0.0721	256.9784	25.9224	0.0690	25.9914		4,636.2726	4,636.2726	0.0199	0.6388	4,827.1203
Worker	1.4471	0.8435	9.1226	0.0216	540.7786	0.0138	540.7924	54.3884	0.0127	54.4011		2,225.6930	2,225.6930	0.0949	0.0814	2,252.3293
<b>Total</b>	<b>1.9713</b>	<b>15.9601</b>	<b>14.8208</b>	<b>0.1007</b>	<b>992.7113</b>	<b>0.1662</b>	<b>992.8774</b>	<b>99.9610</b>	<b>0.1585</b>	<b>100.1195</b>		<b>10,575.3135</b>	<b>10,575.3135</b>	<b>0.1249</b>	<b>1.3039</b>	<b>10,966.9995</b>

EEC ORIGINAL PKG



Green Valley Logistics (Imperial County) - Imperial County, Winter

**EMFAC Off-Model Adjustment Factors for Gasoline Light Duty Vehicle to Account for the SAFE Vehicle Rule Applied**

**3.4 Building Construction - 2024**

**Mitigated Construction On-Site**

Category	lb/day															
	ROG	NOx	CO	SO2	Fugitive PM10	Exhaust PM10	PM10 Total	Fugitive PM2.5	Exhaust PM2.5	PM2.5 Total	Bio- CO2	NBio- CO2	Total CO2	CH4	N2O	CO2e
Off-Road	0.8054	16.7936	20.7901	0.0311		0.1510	0.1510		0.1510	0.1510	0.0000	2,970.240 4	2,970.240 4	0.9147		2,993.108 1
<b>Total</b>	<b>0.8054</b>	<b>16.7936</b>	<b>20.7901</b>	<b>0.0311</b>		<b>0.1510</b>	<b>0.1510</b>		<b>0.1510</b>	<b>0.1510</b>	<b>0.0000</b>	<b>2,970.240 4</b>	<b>2,970.240 4</b>	<b>0.9147</b>		<b>2,993.108 1</b>

**Mitigated Construction Off-Site**

Category	lb/day															
	ROG	NOx	CO	SO2	Fugitive PM10	Exhaust PM10	PM10 Total	Fugitive PM2.5	Exhaust PM2.5	PM2.5 Total	Bio- CO2	NBio- CO2	Total CO2	CH4	N2O	CO2e
Hauling	0.1443	6.9620	1.9478	0.0351	195.0264	0.0803	195.1066	19.6502	0.0768	19.7270		3,713.347 9	3,713.347 9	9.900e- 003	0.5637	3,887.549 9
Vendor	0.3799	8.1546	3.7503	0.0441	256.9063	0.0721	256.9784	25.9224	0.0690	25.9914		4,636.272 6	4,636.272 6	0.0199	0.6388	4,827.120 3
Worker	1.4471	0.8435	9.1226	0.0216	540.7786	0.0138	540.7924	54.3884	0.0127	54.4011		2,225.693 0	2,225.693 0	0.0949	0.0814	2,252.329 3
<b>Total</b>	<b>1.9713</b>	<b>15.9601</b>	<b>14.8208</b>	<b>0.1007</b>	<b>992.7113</b>	<b>0.1662</b>	<b>992.8774</b>	<b>99.9610</b>	<b>0.1585</b>	<b>100.1195</b>		<b>10,575.31 35</b>	<b>10,575.31 35</b>	<b>0.1249</b>	<b>1.3039</b>	<b>10,966.99 95</b>

**EEO ORIGINAL PKG**

Green Valley Logistics (Imperial County) - Imperial County, Winter

**EMFAC Off-Model Adjustment Factors for Gasoline Light Duty Vehicle to Account for the SAFE Vehicle Rule Applied**

**3.4 Building Construction - 2025**

**Unmitigated Construction On-Site**

Category	ROG	NOx	CO	SO2	Fugitive PM10	Exhaust PM10	PM10 Total	Fugitive PM2.5	Exhaust PM2.5	PM2.5 Total	Bio- CO2	NBio- CO2	Total CO2	CH4	N2O	CO2e
	lb/day															
Off-Road	1.3760	14.0000	17.2964	0.0311	0.5085	0.5085	0.5085	0.4711	0.4711	0.4711		2,970.9950	2,970.9950	0.9135		2,993.8323
<b>Total</b>	<b>1.3760</b>	<b>14.0000</b>	<b>17.2964</b>	<b>0.0311</b>	<b>0.5085</b>	<b>0.5085</b>	<b>0.5085</b>	<b>0.4711</b>	<b>0.4711</b>	<b>0.4711</b>		<b>2,970.9950</b>	<b>2,970.9950</b>	<b>0.9135</b>		<b>2,993.8323</b>

**Unmitigated Construction Off-Site**

Category	ROG	NOx	CO	SO2	Fugitive PM10	Exhaust PM10	PM10 Total	Fugitive PM2.5	Exhaust PM2.5	PM2.5 Total	Bio- CO2	NBio- CO2	Total CO2	CH4	N2O	CO2e
	lb/day															
Hauling	0.1441	6.8719	1.9516	0.0343	195.0264	0.0797	195.1061	19.6502	0.0763	19.7265		3,627.8922	3,627.8922	0.0104	0.5703	3,798.0993
Vendor	0.3692	8.0408	3.6473	0.0433	256.9063	0.0717	256.9780	25.9224	0.0686	25.9910		4,555.9696	4,555.9696	0.0195	0.6237	4,742.3230
Worker	1.3468	0.7543	8.4621	0.0208	540.7786	0.0130	540.7917	54.3884	0.0120	54.4004		2,171.4654	2,171.4654	0.0860	0.0757	2,196.1716
<b>Total</b>	<b>1.8602</b>	<b>15.6670</b>	<b>14.0611</b>	<b>0.0984</b>	<b>992.7113</b>	<b>0.1645</b>	<b>992.8756</b>	<b>99.9610</b>	<b>0.1569</b>	<b>100.1179</b>		<b>10,355.3271</b>	<b>10,355.3271</b>	<b>0.1158</b>	<b>1.2697</b>	<b>10,736.5939</b>

EEC ORIGINAL PKG

Green Valley Logistics (Imperial County) - Imperial County, Winter

**EMFAC Off-Model Adjustment Factors for Gasoline Light Duty Vehicle to Account for the SAFE Vehicle Rule Applied**

**3.4 Building Construction - 2025**

**Mitigated Construction On-Site**

Category	lb/day															
	ROG	NOx	CO	SO2	Fugitive PM10	Exhaust PM10	PM10 Total	Fugitive PM2.5	Exhaust PM2.5	PM2.5 Total	Bio- CO2	NBio- CO2	Total CO2	CH4	N2O	CO2e
Off-Road	0.8054	16.7936	20.7901	0.0311		0.1510	0.1510		0.1510	0.1510	0.0000	2,970.9950	2,970.9950	0.9135		2,993.8323
<b>Total</b>	<b>0.8054</b>	<b>16.7936</b>	<b>20.7901</b>	<b>0.0311</b>		<b>0.1510</b>	<b>0.1510</b>		<b>0.1510</b>	<b>0.1510</b>	<b>0.0000</b>	<b>2,970.9950</b>	<b>2,970.9950</b>	<b>0.9135</b>		<b>2,993.8323</b>

**Mitigated Construction Off-Site**

Category	lb/day															
	ROG	NOx	CO	SO2	Fugitive PM10	Exhaust PM10	PM10 Total	Fugitive PM2.5	Exhaust PM2.5	PM2.5 Total	Bio- CO2	NBio- CO2	Total CO2	CH4	N2O	CO2e
Hauling	0.1441	6.8719	1.9516	0.0343	195.0264	0.0797	195.1061	19.6502	0.0763	19.7265		3,627.8922	3,627.8922	0.0104	0.5703	3,798.0993
Vendor	0.3692	8.0408	3.6473	0.0433	256.9063	0.0717	256.9780	25.9224	0.0686	25.9910		4,555.9696	4,555.9696	0.0195	0.6237	4,742.3230
Worker	1.3468	0.7543	8.4621	0.0208	540.7786	0.0130	540.7917	54.3884	0.0120	54.4004		2,171.4654	2,171.4654	0.0860	0.0757	2,196.1716
<b>Total</b>	<b>1.8602</b>	<b>15.6670</b>	<b>14.0611</b>	<b>0.0984</b>	<b>992.7113</b>	<b>0.1645</b>	<b>992.8758</b>	<b>99.9610</b>	<b>0.1569</b>	<b>100.1179</b>		<b>10,355.3271</b>	<b>10,355.3271</b>	<b>0.1158</b>	<b>1.2697</b>	<b>10,736.5939</b>

REC ORIGINAL PKG

Green Valley Logistics (Imperial County) - Imperial County, Winter

**EMFAC Off-Model Adjustment Factors for Gasoline Light Duty Vehicle to Account for the SAFE Vehicle Rule Applied**

**3.5 Paving - 2024**

**Unmitigated Construction On-Site**

Category	ROG	NOx	CO	SO2	Fugitive PM10	Exhaust PM10	PM10 Total	Fugitive PM2.5	Exhaust PM2.5	PM2.5 Total	Bio- CO2	NBio- CO2	Total CO2	CH4	N2O	CO2e
	lb/day															
Off-Road	0.9882	9.5246	14.6258	0.0228		0.4685	0.4685	0.4310	0.4310	0.4310		2,207.547 <sup>2</sup>	2,207.547 <sup>2</sup>	0.7140		2,225.396 <sup>3</sup>
Paving	0.4192					0.0000	0.0000	0.0000	0.0000	0.0000			0.0000			0.0000
<b>Total</b>	<b>1.4074</b>	<b>9.5246</b>	<b>14.6258</b>	<b>0.0228</b>		<b>0.4685</b>	<b>0.4685</b>	<b>0.4310</b>	<b>0.4310</b>	<b>0.4310</b>		<b>2,207.547<sup>2</sup></b>	<b>2,207.547<sup>2</sup></b>	<b>0.7140</b>		<b>2,225.396<sup>3</sup></b>

**Unmitigated Construction Off-Site**

Category	ROG	NOx	CO	SO2	Fugitive PM10	Exhaust PM10	PM10 Total	Fugitive PM2.5	Exhaust PM2.5	PM2.5 Total	Bio- CO2	NBio- CO2	Total CO2	CH4	N2O	CO2e
	lb/day															
Hauling	0.0000	0.0000	0.0000	0.0000	0.0000	0.0000	0.0000	0.0000	0.0000	0.0000			0.0000	0.0000		0.0000
Vendor	0.0000	0.0000	0.0000	0.0000	0.0000	0.0000	0.0000	0.0000	0.0000	0.0000			0.0000	0.0000		0.0000
Worker	0.0433	0.0253	0.2731	6.5000e-004	16.1910	4.1000e-004	16.1914	1.6284	3.8000e-004	1.6288		66.6375	66.6375	2.8400e-003	2.4400e-003	67.4350
<b>Total</b>	<b>0.0433</b>	<b>0.0253</b>	<b>0.2731</b>	<b>6.5000e-004</b>	<b>16.1910</b>	<b>4.1000e-004</b>	<b>16.1914</b>	<b>1.6284</b>	<b>3.8000e-004</b>	<b>1.6288</b>		<b>66.6375</b>	<b>66.6375</b>	<b>2.8400e-003</b>	<b>2.4400e-003</b>	<b>67.4350</b>

FEC ORIGINAL PKG



Green Valley Logistics (Imperial County) - Imperial County, Winter

**EMFAC Off-Model Adjustment Factors for Gasoline Light Duty Vehicle to Account for the SAFE Vehicle Rule Applied**

**3.5 Paving - 2024**

**Mitigated Construction On-Site**

Category	ROG	NOx	CO	SO2	Fugitive PM10	Exhaust PM10	PM10 Total	Fugitive PM2.5	Exhaust PM2.5	PM2.5 Total	Bio- CO2	NBio- CO2	Total CO2	CH4	N2O	CO2e
lb/day																
Off-Road	0.5609	11.2952	17.2957	0.0228	0.0914	0.0914	0.0914	0.0914	0.0914	0.0914	0.0000	2,207.547 <sub>2</sub>	2,207.547 <sub>2</sub>	0.7140		2,225.396 <sub>3</sub>
Paving	0.4192				0.0000	0.0000	0.0000	0.0000	0.0000	0.0000		0.0000	0.0000			0.0000
<b>Total</b>	<b>0.9801</b>	<b>11.2952</b>	<b>17.2957</b>	<b>0.0228</b>	<b>0.0914</b>	<b>0.0914</b>	<b>0.0914</b>	<b>0.0914</b>	<b>0.0914</b>	<b>0.0914</b>	<b>0.0000</b>	<b>2,207.547<sub>2</sub></b>	<b>2,207.547<sub>2</sub></b>	<b>0.7140</b>		<b>2,225.396<sub>3</sub></b>

**Mitigated Construction Off-Site**

Category	ROG	NOx	CO	SO2	Fugitive PM10	Exhaust PM10	PM10 Total	Fugitive PM2.5	Exhaust PM2.5	PM2.5 Total	Bio- CO2	NBio- CO2	Total CO2	CH4	N2O	CO2e
lb/day																
Hauling	0.0000	0.0000	0.0000	0.0000	0.0000	0.0000	0.0000	0.0000	0.0000	0.0000		0.0000	0.0000	0.0000		0.0000
Vendor	0.0000	0.0000	0.0000	0.0000	0.0000	0.0000	0.0000	0.0000	0.0000	0.0000		0.0000	0.0000	0.0000		0.0000
Worker	0.0433	0.0253	0.2731	6.5000e-004	16.1910	4.1000e-004	16.1914	1.6284	3.8000e-004	1.6288		66.6375	66.6375	2.8400e-003	2.4400e-003	67.4350
<b>Total</b>	<b>0.0433</b>	<b>0.0253</b>	<b>0.2731</b>	<b>6.5000e-004</b>	<b>16.1910</b>	<b>4.1000e-004</b>	<b>16.1914</b>	<b>1.6284</b>	<b>3.8000e-004</b>	<b>1.6288</b>		<b>66.6375</b>	<b>66.6375</b>	<b>2.8400e-003</b>	<b>2.4400e-003</b>	<b>67.4350</b>

EEC ORIGINAL PKG



Green Valley Logistics (Imperial County) - Imperial County, Winter

**EMFAC Off-Model Adjustment Factors for Gasoline Light Duty Vehicle to Account for the SAFE Vehicle Rule Applied**

**3.6 Architectural Coating - 2024**

**Unmitigated Construction On-Site**

Category	ROG	NOx	CO	SO2	Fugitive PM10	Exhaust PM10	PM10 Total	Fugitive PM2.5	Exhaust PM2.5	PM2.5 Total	Bio- CO2	NBio- CO2	Total CO2	CH4	N2O	CO2e
	lb/day															
Archit. Coating	65.2891					0.0000	0.0000		0.0000	0.0000			0.0000			0.0000
Off-Road	0.1808	1.2188	1.8101	2.9700e-003		0.0609	0.0609		0.0609	0.0609			281.4481	0.0159		281.8443
<b>Total</b>	<b>65.4699</b>	<b>1.2188</b>	<b>1.8101</b>	<b>2.9700e-003</b>		<b>0.0609</b>	<b>0.0609</b>		<b>0.0609</b>	<b>0.0609</b>			<b>281.4481</b>	<b>0.0159</b>		<b>281.8443</b>

**Unmitigated Construction Off-Site**

Category	ROG	NOx	CO	SO2	Fugitive PM10	Exhaust PM10	PM10 Total	Fugitive PM2.5	Exhaust PM2.5	PM2.5 Total	Bio- CO2	NBio- CO2	Total CO2	CH4	N2O	CO2e
	lb/day															
Hauling	0.0000	0.0000	0.0000	0.0000	0.0000	0.0000	0.0000	0.0000	0.0000	0.0000			0.0000	0.0000		0.0000
Vendor	0.0000	0.0000	0.0000	0.0000	0.0000	0.0000	0.0000	0.0000	0.0000	0.0000			0.0000	0.0000		0.0000
Worker	0.2888	0.1684	1.8209	4.3100e-003	107.9399	2.7500e-003	107.9426	10.8560	2.5400e-003	10.8585			444.2501	0.0190	0.0163	449.5667
<b>Total</b>	<b>0.2888</b>	<b>0.1684</b>	<b>1.8209</b>	<b>4.3100e-003</b>	<b>107.9399</b>	<b>2.7500e-003</b>	<b>107.9426</b>	<b>10.8560</b>	<b>2.5400e-003</b>	<b>10.8585</b>			<b>444.2501</b>	<b>0.0190</b>	<b>0.0163</b>	<b>449.5667</b>

REC ORIGINAL PKG

Green Valley Logistics (Imperial County) - Imperial County, Winter

**EMFAC Off-Model Adjustment Factors for Gasoline Light Duty Vehicle to Account for the SAFE Vehicle Rule Applied**

**3.6 Architectural Coating - 2024**

**Mitigated Construction On-Site**

Category	lb/day															
	ROG	NOx	CO	SO2	Fugitive PM10	Exhaust PM10	PM10 Total	Fugitive PM2.5	Exhaust PM2.5	PM2.5 Total	Bio- CO2	NBio- CO2	Total CO2	CH4	N2O	CO2e
Archit. Coating	65.2891					0.0000	0.0000	0.0000	0.0000	0.0000			0.0000			0.0000
Off-Road	0.0594	1.3570	1.8324	2.9700e-003		0.0143	0.0143	0.0143	0.0143	0.0143	0.0000	281.4481	281.4481	0.0159		281.8443
<b>Total</b>	<b>65.3486</b>	<b>1.3570</b>	<b>1.8324</b>	<b>2.9700e-003</b>		<b>0.0143</b>	<b>0.0143</b>	<b>0.0143</b>	<b>0.0143</b>	<b>0.0143</b>	<b>0.0000</b>	<b>281.4481</b>	<b>281.4481</b>	<b>0.0159</b>		<b>281.8443</b>

**Mitigated Construction Off-Site**

Category	lb/day															
	ROG	NOx	CO	SO2	Fugitive PM10	Exhaust PM10	PM10 Total	Fugitive PM2.5	Exhaust PM2.5	PM2.5 Total	Bio- CO2	NBio- CO2	Total CO2	CH4	N2O	CO2e
Hauling	0.0000	0.0000	0.0000	0.0000	0.0000	0.0000	0.0000	0.0000	0.0000	0.0000			0.0000	0.0000		0.0000
Vendor	0.0000	0.0000	0.0000	0.0000	0.0000	0.0000	0.0000	0.0000	0.0000	0.0000			0.0000	0.0000		0.0000
Worker	0.2888	0.1684	1.8209	4.3100e-003	107.9399	2.7500e-003	107.9426	10.8560	2.5400e-003	10.8585		444.2501	444.2501	0.0190	0.0163	449.5667
<b>Total</b>	<b>0.2888</b>	<b>0.1684</b>	<b>1.8209</b>	<b>4.3100e-003</b>	<b>107.9399</b>	<b>2.7500e-003</b>	<b>107.9426</b>	<b>10.8560</b>	<b>2.5400e-003</b>	<b>10.8585</b>		<b>444.2501</b>	<b>444.2501</b>	<b>0.0190</b>	<b>0.0163</b>	<b>449.5667</b>

EEC ORIGINAL PKG

Green Valley Logistics (Imperial County) - Imperial County, Winter

**EMFAC Off-Model Adjustment Factors for Gasoline Light Duty Vehicle to Account for the SAFE Vehicle Rule Applied**

**3.6 Architectural Coating - 2025  
Unmitigated Construction On-Site**

Category	ROG	NOx	CO	SO2	Fugitive PM10	Exhaust PM10	PM10 Total	Fugitive PM2.5	Exhaust PM2.5	PM2.5 Total	Bio- CO2	NBio- CO2	Total CO2	CH4	N2O	CO2e
lb/day																
Archit. Coating	65.2891					0.0000	0.0000		0.0000	0.0000			0.0000			0.0000
Off-Road	0.1709	1.1455	1.8091	2.9700e-003		0.0515	0.0515		0.0515	0.0515		281.4481	281.4481	0.0154		281.8319
<b>Total</b>	<b>65.4600</b>	<b>1.1455</b>	<b>1.8091</b>	<b>2.9700e-003</b>		<b>0.0515</b>	<b>0.0515</b>		<b>0.0515</b>	<b>0.0515</b>		<b>281.4481</b>	<b>281.4481</b>	<b>0.0154</b>		<b>281.8319</b>

**Unmitigated Construction Off-Site**

Category	ROG	NOx	CO	SO2	Fugitive PM10	Exhaust PM10	PM10 Total	Fugitive PM2.5	Exhaust PM2.5	PM2.5 Total	Bio- CO2	NBio- CO2	Total CO2	CH4	N2O	CO2e
lb/day																
Hauling	0.0000	0.0000	0.0000	0.0000	0.0000	0.0000	0.0000	0.0000	0.0000	0.0000			0.0000	0.0000	0.0000	0.0000
Vendor	0.0000	0.0000	0.0000	0.0000	0.0000	0.0000	0.0000	0.0000	0.0000	0.0000			0.0000	0.0000	0.0000	0.0000
Worker	0.2688	0.1506	1.6890	4.1600e-003	107.9399	2.6000e-003	107.9425	10.8560	2.3900e-003	10.8584		433.4262	433.4262	0.0172	0.0151	438.3576
<b>Total</b>	<b>0.2688</b>	<b>0.1506</b>	<b>1.6890</b>	<b>4.1600e-003</b>	<b>107.9399</b>	<b>2.6000e-003</b>	<b>107.9425</b>	<b>10.8560</b>	<b>2.3900e-003</b>	<b>10.8584</b>		<b>433.4262</b>	<b>433.4262</b>	<b>0.0172</b>	<b>0.0151</b>	<b>438.3576</b>

EEC ORIGINAL PKG

Green Valley Logistics (Imperial County) - Imperial County, Winter

**EMFAC Off-Model Adjustment Factors for Gasoline Light Duty Vehicle to Account for the SAFE Vehicle Rule Applied**

**3.6 Architectural Coating - 2025**

**Mitigated Construction On-Site**

Category	lb/day																
	ROG	NOx	CO	SO2	Fugitive PM10	Exhaust PM10	PM10 Total	Fugitive PM2.5	Exhaust PM2.5	PM2.5 Total	Bio- CO2	NBio- CO2	Total CO2	CH4	N2O	CO2e	
Archit. Coating	65.2891					0.0000	0.0000		0.0000	0.0000			0.0000				0.0000
Off-Road	0.0594	1.3570	1.8324	2.9700e-003		0.0143	0.0143		0.0143	0.0143	0.0000	281.4481	281.4481	0.0154			281.8319
<b>Total</b>	<b>65.3486</b>	<b>1.3570</b>	<b>1.8324</b>	<b>2.9700e-003</b>		<b>0.0143</b>	<b>0.0143</b>		<b>0.0143</b>	<b>0.0143</b>	<b>0.0000</b>	<b>281.4481</b>	<b>281.4481</b>	<b>0.0154</b>			<b>281.8319</b>

**Mitigated Construction Off-Site**

Category	lb/day																
	ROG	NOx	CO	SO2	Fugitive PM10	Exhaust PM10	PM10 Total	Fugitive PM2.5	Exhaust PM2.5	PM2.5 Total	Bio- CO2	NBio- CO2	Total CO2	CH4	N2O	CO2e	
Hauling	0.0000	0.0000	0.0000	0.0000	0.0000	0.0000	0.0000	0.0000	0.0000	0.0000			0.0000	0.0000	0.0000		0.0000
Vendor	0.0000	0.0000	0.0000	0.0000	0.0000	0.0000	0.0000	0.0000	0.0000	0.0000			0.0000	0.0000	0.0000		0.0000
Worker	0.2688	0.1506	1.6890	4.1600e-003	107.9399	2.6000e-003	107.9425	10.8560	2.3900e-003	10.8584	433.4262	433.4262	433.4262	0.0172	0.0151		438.3576
<b>Total</b>	<b>0.2688</b>	<b>0.1506</b>	<b>1.6890</b>	<b>4.1600e-003</b>	<b>107.9399</b>	<b>2.6000e-003</b>	<b>107.9425</b>	<b>10.8560</b>	<b>2.3900e-003</b>	<b>10.8584</b>	<b>433.4262</b>	<b>433.4262</b>	<b>433.4262</b>	<b>0.0172</b>	<b>0.0151</b>		<b>438.3576</b>

EEC ORIGINAL PKG



Green Valley Logistics (Imperial County) - Imperial County, Winter

**EMFAC Off-Model Adjustment Factors for Gasoline Light Duty Vehicle to Account for the SAFE Vehicle Rule Applied**

**4.0 Operational Detail - Mobile**

**4.1 Mitigation Measures Mobile**

Category	lb/day															
	ROG	NOx	CO	SO2	Fugitive PM10	Exhaust PM10	PM10 Total	Fugitive PM2.5	Exhaust PM2.5	PM2.5 Total	Bio- CO2	NBio- CO2	Total CO2	CH4	N2O	CO2e
Mitigated	0.0206	0.0168	0.2477	7.0000e-004	10.5142	4.3000e-004	10.5146	1.0632	4.0000e-004	1.0636	73.0773	73.0773	73.0773	2.5500e-003	2.3200e-003	73.8317
Unmitigated	0.0206	0.0168	0.2477	7.0000e-004	10.5142	4.3000e-004	10.5146	1.0632	4.0000e-004	1.0636	73.0773	73.0773	73.0773	2.5500e-003	2.3200e-003	73.8317

**4.2 Trip Summary Information**

Land Use	Average Daily Trip Rate			Unmitigated Annual VMT	Mitigated Annual VMT
	Weekday	Saturday	Sunday		
Convenience Market with Gas Pumps	0.00	0.00	0.00		
General Heavy Industry	21.50	21.50	21.50	50,947	50,947
Parking Lot	0.00	0.00	0.00		
Unrefrigerated Warehouse-Rail	0.00	0.00	0.00		
<b>Total</b>	<b>21.50</b>	<b>21.50</b>	<b>21.50</b>	<b>50,947</b>	<b>50,947</b>

**4.3 Trip Type Information**

Land Use	Miles					Trip %			Trip Purpose %		
	H-W or C-W	H-S or C-C	H-O or C-NW	H-W or C-W	H-S or C-C	H-O or C-NW	Primary	Diverted	Pass-by		
Convenience Market with Gas	6.70	5.00	8.90	0.80	80.20	19.00	0	0	0		
General Heavy Industry	6.70	5.00	8.90	59.00	28.00	13.00	100	0	0		
Parking Lot	6.70	5.00	8.90	0.00	0.00	0.00	0	0	0		



Green Valley Logistics (Imperial County) - Imperial County, Winter

**EMFAC Off-Model Adjustment Factors for Gasoline Light Duty Vehicle to Account for the SAFE Vehicle Rule Applied**

Land Use	Miles				Trip %				Trip Purpose %			
	H-W or C-W	H-S or C-C	H-O or C-NW	H-W or C-W	H-S or C-C	H-O or C-NW	Primary	Diverted	Pass-by			
Unrefrigerated Warehouse-Rail	6.70	5.00	8.90	59.00	0.00	41.00	0	0	0			

**4.4 Fleet Mix**

Land Use	LDA	LDT1	LDT2	MDV	LHD1	LHD2	MHD	HHD	OBUS	UBUS	MCY	SBUS	MH
Convenience Market with Gas Pumps	0.530702	0.059328	0.179664	0.144474	0.026250	0.006790	0.008325	0.016302	0.000941	0.000118	0.022966	0.000752	0.0003388
General Heavy Industry	1.000000	0.000000	0.000000	0.000000	0.000000	0.000000	0.000000	0.000000	0.000000	0.000000	0.000000	0.000000	0.000000
Parking Lot	0.530702	0.059328	0.179664	0.144474	0.026250	0.006790	0.008325	0.016302	0.000941	0.000118	0.022966	0.000752	0.0003388
Unrefrigerated Warehouse-Rail	0.530702	0.059328	0.179664	0.144474	0.026250	0.006790	0.008325	0.016302	0.000941	0.000118	0.022966	0.000752	0.0003388

**5.0 Energy Detail**

Historical Energy Use: N

**5.1 Mitigation Measures Energy**

Category	ROG	NOx	CO	SO2	Fugitive PM10	Exhaust PM10	PM10 Total	Fugitive PM2.5	Exhaust PM2.5	PM2.5 Total	Bio-CO2	NBio-CO2	Total CO2	CH4	N2O	CO2e
Natural Gas Mitigated	0.1073	0.9754	0.8194	5.8500e-003	0.0741	0.0741	0.0741	0.0741	0.0741	0.0741	1,170.4978	1,170.4978	1,170.4978	0.0224	0.0215	1,177.4535
Natural Gas Unmitigated	0.1073	0.9754	0.8194	5.8500e-003	0.0741	0.0741	0.0741	0.0741	0.0741	0.0741	1,170.4978	1,170.4978	1,170.4978	0.0224	0.0215	1,177.4535

EFC ORIGINAL PKG

Green Valley Logistics (Imperial County) - Imperial County, Winter

**EMFAC Off-Model Adjustment Factors for Gasoline Light Duty Vehicle to Account for the SAFE Vehicle Rule Applied**

**5.2 Energy by Land Use - Natural Gas**

Unmitigated

Land Use	Natural Gas Use kBTU/yr	lb/day										lb/day						
		ROG	NOx	CO	SO2	Fugitive PM10	Exhaust PM10	PM10 Total	Fugitive PM2.5	Exhaust PM2.5	PM2.5 Total	Bio- CO2	NBio- CO2	Total CO2	CH4	N2O	CO2e	
Convenience Market with Gas Pumps	13.6147	1.5000e-004	1.3300e-003	1.1200e-003	1.0000e-005	1.0000e-004	1.0000e-004	1.0000e-004	1.0000e-004	1.0000e-004	1.0000e-004		1.6017	1.6017	3.0000e-005	3.0000e-005	3.0000e-005	1.6113
General Heavy Industry	4428.77	0.0478	0.4342	0.3647	2.6100e-003	0.0330	0.0330	0.0330	0.0330	0.0330	0.0330		521.0314	521.0314	9.9900e-003	9.9900e-003	9.9900e-003	524.1277
Parking Lot	0	0.0000	0.0000	0.0000	0.0000	0.0000	0.0000	0.0000	0.0000	0.0000	0.0000		0.0000	0.0000	0.0000	0.0000	0.0000	0.0000
Unrefrigerated Warehouse-Rail	5506.85	0.0594	0.5399	0.4535	3.2400e-003	0.0410	0.0410	0.0410	0.0410	0.0410	0.0410		647.8646	647.8646	0.0124	0.0119	0.0119	651.7146
<b>Total</b>		<b>0.1073</b>	<b>0.9754</b>	<b>0.8194</b>	<b>5.8600e-003</b>	<b>0.0741</b>	<b>0.0741</b>	<b>0.0741</b>	<b>0.0741</b>	<b>0.0741</b>	<b>0.0741</b>		<b>1,170.4978</b>	<b>1,170.4978</b>	<b>0.0224</b>	<b>0.0215</b>	<b>0.0215</b>	<b>1,177.4535</b>

Green Valley Logistics (Imperial County) - Imperial County, Winter

**EMFAC Off-Model Adjustment Factors for Gasoline Light Duty Vehicle to Account for the SAFE Vehicle Rule Applied**

**5.2 Energy by Land Use - Natural Gas**

**Mitigated**

Land Use	Natural Gas Use kBTU/yr	lb/day										lb/day						
		ROG	NOx	CO	SO2	Fugitive PM10	Exhaust PM10	PM10 Total	Fugitive PM2.5	Exhaust PM2.5	PM2.5 Total	Bio- CO2	NBio- CO2	Total CO2	CH4	N2O	CO2e	
Convenience Market with Gas Pumps	0.0136147	1.5000e-004	1.3300e-003	1.1200e-003	1.0000e-005	1.0000e-004	1.0000e-004	1.0000e-004	1.0000e-004	1.0000e-004	1.0000e-004	1.6017	1.6017	1.6017	3.0000e-005	3.0000e-005	3.0000e-005	1.6113
General Heavy Industry	4.42877	0.0478	0.4342	0.3647	2.6100e-003	0.0330	0.0330	0.0330	0.0330	0.0330	0.0330	521.0314	521.0314	521.0314	9.9900e-003	9.9900e-003	9.9900e-003	524.1277
Parking Lot	0	0.0000	0.0000	0.0000	0.0000	0.0000	0.0000	0.0000	0.0000	0.0000	0.0000	0.0000	0.0000	0.0000	0.0000	0.0000	0.0000	0.0000
Unrefrigerated Warehouse-Rail	5.50685	0.0594	0.5399	0.4535	3.2400e-003	0.0410	0.0410	0.0410	0.0410	0.0410	0.0410	647.8646	647.8646	647.8646	0.0124	0.0119	0.0119	651.7146
<b>Total</b>		<b>0.1073</b>	<b>0.9754</b>	<b>0.8194</b>	<b>5.8600e-003</b>	<b>0.0741</b>	<b>0.0741</b>	<b>0.0741</b>	<b>0.0741</b>	<b>0.0741</b>	<b>0.0741</b>	<b>1,170.4978</b>	<b>1,170.4978</b>	<b>1,170.4978</b>	<b>0.0224</b>	<b>0.0215</b>	<b>0.0215</b>	<b>1,177.4535</b>

**6.0 Area Detail**

**6.1 Mitigation Measures Area**

Green Valley Logistics (Imperial County) - Imperial County, Winter

**EMFAC Off-Model Adjustment Factors for Gasoline Light Duty Vehicle to Account for the SAFE Vehicle Rule Applied**

Category	ROG	NOx	CO	SO2	Fugitive PM10	Exhaust PM10	PM10 Total	Fugitive PM2.5	Exhaust PM2.5	PM2.5 Total	Bio- CO2	NBio- CO2	Total CO2	CH4	N2O	CO2e
	lb/day															
Mitigated	26.6059	1.3100e-003	0.1442	1.0000e-005		5.1000e-004	5.1000e-004		5.1000e-004	5.1000e-004		0.3099	0.3099	8.1000e-004		0.3301
Unmitigated	26.6059	1.3100e-003	0.1442	1.0000e-005		5.1000e-004	5.1000e-004		5.1000e-004	5.1000e-004		0.3099	0.3099	8.1000e-004		0.3301

**6.2 Area by SubCategory**

**Unmitigated**

SubCategory	ROG	NOx	CO	SO2	Fugitive PM10	Exhaust PM10	PM10 Total	Fugitive PM2.5	Exhaust PM2.5	PM2.5 Total	Bio- CO2	NBio- CO2	Total CO2	CH4	N2O	CO2e
	lb/day															
Architectural Coating	4.0247					0.0000	0.0000		0.0000	0.0000			0.0000			0.0000
Consumer Products	22.5679					0.0000	0.0000		0.0000	0.0000			0.0000			0.0000
Landscaping	0.0133	1.3100e-003	0.1442	1.0000e-005		5.1000e-004	5.1000e-004		5.1000e-004	5.1000e-004		0.3099	0.3099	8.1000e-004		0.3301
<b>Total</b>	<b>26.6059</b>	<b>1.3100e-003</b>	<b>0.1442</b>	<b>1.0000e-005</b>		<b>5.1000e-004</b>	<b>5.1000e-004</b>		<b>5.1000e-004</b>	<b>5.1000e-004</b>		<b>0.3099</b>	<b>0.3099</b>	<b>8.1000e-004</b>		<b>0.3301</b>

REC ORIGINAL PKG

Green Valley Logistics (Imperial County) - Imperial County, Winter

**EMFAC Off-Model Adjustment Factors for Gasoline Light Duty Vehicle to Account for the SAFE Vehicle Rule Applied**

**6.2 Area by SubCategory**

**Mitigated**

SubCategory	ROG	NOx	CO	SO2	Fugitive PM10	Exhaust PM10	PM10 Total	Fugitive PM2.5	Exhaust PM2.5	PM2.5 Total	Bio- CO2	NBio- CO2	Total CO2	CH4	N2O	CO2e
	lb/day															
Architectural Coating	4.0247					0.0000	0.0000		0.0000	0.0000			0.0000			0.0000
Consumer Products	22.5679					0.0000	0.0000		0.0000	0.0000			0.0000			0.0000
Landscaping	0.0133	1.3100e-003	0.1442	1.0000e-005		5.1000e-004	5.1000e-004		5.1000e-004	5.1000e-004		0.3099	0.3099	8.1000e-004		0.3301
<b>Total</b>	<b>26.6059</b>	<b>1.3100e-003</b>	<b>0.1442</b>	<b>1.0000e-005</b>		<b>5.1000e-004</b>	<b>5.1000e-004</b>		<b>5.1000e-004</b>	<b>5.1000e-004</b>		<b>0.3099</b>	<b>0.3099</b>	<b>8.1000e-004</b>		<b>0.3301</b>

**7.0 Water Detail**

**7.1 Mitigation Measures Water**

EEC ORIGINAL PKG



Green Valley Logistics (Imperial County) - Imperial County, Winter

**EMFAC Off-Model Adjustment Factors for Gasoline Light Duty Vehicle to Account for the SAFE Vehicle Rule Applied**

**8.0 Waste Detail**

**8.1 Mitigation Measures Waste**

**9.0 Operational Offroad**

Equipment Type	Number	Hours/Day	Days/Year	Horse Power	Load Factor	Fuel Type
----------------	--------	-----------	-----------	-------------	-------------	-----------

**10.0 Stationary Equipment**

**Fire Pumps and Emergency Generators**

Equipment Type	Number	Hours/Day	Hours/Year	Horse Power	Load Factor	Fuel Type
----------------	--------	-----------	------------	-------------	-------------	-----------

**Boilers**

Equipment Type	Number	Heat Input/Day	Heat Input/Year	Boiler Rating	Fuel Type
----------------	--------	----------------	-----------------	---------------	-----------

**User Defined Equipment**

Equipment Type	Number
----------------	--------

**110 Vegetation**

**ATTACHMENT B**

CalEEMod (Mitigated)

Green Valley Logistics (Imperial County) - Mitigated - Imperial County, Summer  
**EMFAC Off-Model Adjustment Factors for Gasoline Light Duty Vehicle to Account for the SAFE Vehicle Rule Applied**

**Green Valley Logistics (Imperial County) - Mitigated**  
 Imperial County, Summer

**1.0 Project Characteristics**

**1.1 Land Usage**

Land Uses	Size	Metric	Lot Acreage	Floor Surface Area	Population
General Heavy Industry	50.00	1000sqft	207.00	50,000.00	0
Unrefrigerated Warehouse-Rail	1,000.00	1000sqft	64.00	1,000,000.00	0
Parking Lot	350.00	Space	4.00	140,000.00	0
Convenience Market with Gas Pumps	16.00	Pump	9.50	2,258.80	0

**1.2 Other Project Characteristics**

Urbanization	Urban	Wind Speed (m/s)	3.4	Precipitation Freq (Days)	12
Climate Zone	15			Operational Year	2025

Utility Company Imperial Irrigation District

CO2 Intensity (lb/MW/hr)	189.98	CH4 Intensity (lb/MW/hr)	0.033	N2O Intensity (lb/MW/hr)	0.004
--------------------------	--------	--------------------------	-------	--------------------------	-------

**1.3 User Entered Comments & Non-Default Data**

Project Characteristics -  
 Land Use - 284.5 acres site  
 Construction Phase - Construction Schedule  
 Off-road Equipment - CE  
 Trips and VMT - Project would use 24,250 trucks to deliver 24CY of stone material per truck during Grading and Building Construction. Per Mitigation Measure AQMM-1... all haul routes and worker trips to and from the site shall be 100% paved.  
 On-road Fugitive Dust - The Project assumes 90% paved. As a mitigation measure, the Project applicant shall prepare a Haul Route Plan which needs to be 100% paved and all worker trips shall utilize 100% paved roadways.  
 Grading - 1,000 CY of export grubbed material  
 Architectural Coating -







Green Valley Logistics (Imperial County) - Mitigated - Imperial County, Summer

EMFAC Off-Model Adjustment Factors for Gasoline Light Duty Vehicle to Account for the SAFE Vehicle Rule Applied

tblFleetMix	MCY	0.02	0.00
tblFleetMix	MDV	0.14	0.00
tblFleetMix	MH	3.3880e-003	0.00
tblFleetMix	MHD	8.3250e-003	0.00
tblFleetMix	OBUS	9.4100e-004	0.00
tblFleetMix	SBUS	7.5200e-004	0.00
tblFleetMix	UBUS	1.1800e-004	0.00
tblGrading	MaterialExported	0.00	1,000.00
tblLandUse	LotAcreage	1.15	207.00
tblLandUse	LotAcreage	22.96	64.00
tblLandUse	LotAcreage	3.15	4.00
tblLandUse	LotAcreage	0.05	9.50
tblOffRoadEquipment	OffRoadEquipmentUnitAmount	1.00	2.00
tblOnRoadDust	HaulingPercentPave	50.00	100.00
tblOnRoadDust	HaulingPercentPave	50.00	100.00
tblOnRoadDust	HaulingPercentPave	50.00	100.00
tblOnRoadDust	HaulingPercentPave	50.00	100.00
tblOnRoadDust	HaulingPercentPave	50.00	100.00
tblOnRoadDust	VendorPercentPave	50.00	100.00
tblOnRoadDust	VendorPercentPave	50.00	100.00
tblOnRoadDust	VendorPercentPave	50.00	100.00
tblOnRoadDust	VendorPercentPave	50.00	100.00
tblOnRoadDust	WorkerPercentPave	50.00	100.00
tblOnRoadDust	WorkerPercentPave	50.00	100.00
tblOnRoadDust	WorkerPercentPave	50.00	100.00
tblOnRoadDust	WorkerPercentPave	50.00	100.00
tblOnRoadDust	WorkerPercentPave	50.00	100.00
tblOnRoadDust	WorkerPercentPave	50.00	100.00
tblOnRoadDust	RoadPercentPave	50	90

FEC ORIGINAL PKG

Green Valley Logistics (Imperial County) - Mitigated - Imperial County, Summer

**EMFAC Off-Model Adjustment Factors for Gasoline Light Duty Vehicle to Account for the SAFE Vehicle Rule Applied**

Category	Factor	Value	Value	Value
tbSolidWaste	SolidWasteGenerationRate	940.00	188.00	
tbTripsAndVMT	HaulingTripNumber	0.00	2,965.35	
tbTripsAndVMT	HaulingTripNumber	0.00	21,284.65	
tbVehicleTrips	DV_TP	21.00	0.00	
tbVehicleTrips	DV_TP	5.00	0.00	
tbVehicleTrips	DV_TP	5.00	0.00	
tbVehicleTrips	PB_TP	65.00	0.00	
tbVehicleTrips	PB_TP	3.00	0.00	
tbVehicleTrips	PB_TP	3.00	0.00	
tbVehicleTrips	PR_TP	14.00	0.00	
tbVehicleTrips	PR_TP	92.00	100.00	
tbVehicleTrips	PR_TP	92.00	0.00	
tbVehicleTrips	ST_TR	322.50	0.00	
tbVehicleTrips	ST_TR	6.42	0.43	
tbVehicleTrips	ST_TR	1.74	0.00	
tbVehicleTrips	SU_TR	322.50	0.00	
tbVehicleTrips	SU_TR	5.09	0.43	
tbVehicleTrips	SU_TR	1.74	0.00	
tbVehicleTrips	WD_TR	322.50	0.00	
tbVehicleTrips	WD_TR	3.93	0.43	
tbVehicleTrips	WD_TR	1.74	0.00	
tbWater	IndoorWaterUseRate	167,314.87	0.00	
tbWater	IndoorWaterUseRate	11,562,500.00	0.00	
tbWater	IndoorWaterUseRate	231,250,000.00	12,000,000.00	
tbWater	OutdoorWaterUseRate	102,547.82	0.00	
tbWater	OutdoorWaterUseRate	0.00	46,650,000.00	

FEC ORIGINAL PKG

**2.0 Emissions Summary**

Green Valley Logistics (Imperial County) - Mitigated - Imperial County, Summer

**EMFAC Off-Model Adjustment Factors for Gasoline Light Duty Vehicle to Account for the SAFE Vehicle Rule Applied**

**2.1 Overall Construction (Maximum Daily Emission)**

**Unmitigated Construction**

Year	ROG	NOx	CO	SO2	Fugitive PM10	Exhaust PM10	PM10 Total	Fugitive PM2.5	Exhaust PM2.5	PM2.5 Total	Bio- CO2	NBio- CO2	Total CO2	CH4	N2O	CO2e
2024	69.9254	66.1857	50.2558	0.1590	30.2808	2.6493	32.9301	14.1434	2.4404	16.5838	0.0000	16,201.82 72	16,201.82 72	3.1544	1.3140	16,633.17 86
2025	69.6396	29.5379	38.2086	0.1408	6.1061	0.7267	6.8328	1.6669	0.6815	2.3484	0.0000	14,476.74 38	14,476.74 38	1.0576	1.2790	14,884.32 61
Maximum	69.9254	66.1857	50.2558	0.1590	30.2808	2.6493	32.9301	14.1434	2.4404	16.5838	0.0000	16,201.82 72	16,201.82 72	3.1544	1.3140	16,633.17 86

**Mitigated Construction**

Year	ROG	NOx	CO	SO2	Fugitive PM10	Exhaust PM10	PM10 Total	Fugitive PM2.5	Exhaust PM2.5	PM2.5 Total	Bio- CO2	NBio- CO2	Total CO2	CH4	N2O	CO2e
2024	69.1412	55.6766	62.6003	0.1590	14.4050	0.4214	14.8264	6.5771	0.4177	6.9948	0.0000	16,201.82 72	16,201.82 72	3.1544	1.3140	16,633.17 86
2025	68.9575	32.5430	41.7256	0.1408	6.1061	0.3319	6.4380	1.6669	0.3241	1.9911	0.0000	14,476.74 38	14,476.74 38	1.0576	1.2790	14,884.32 61
Maximum	69.1412	55.6766	62.6003	0.1590	14.4050	0.4214	14.8264	6.5771	0.4177	6.9948	0.0000	16,201.82 72	16,201.82 72	3.1544	1.3140	16,633.17 86

EEC ORIGINAL PKG

Green Valley Logistics (Imperial County) - Mitigated - Imperial County, Summer

**EMFAC Off-Model Adjustment Factors for Gasoline Light Duty Vehicle to Account for the SAFE Vehicle Rule Applied**

	ROG	NOx	CO	SO2	Fugitive PM10	Exhaust PM10	PM10 Total	Fugitive PM2.5	Exhaust PM2.5	PM2.5 Total	Bio- CO2	NBio-CO2	Total CO2	CH4	N2O	CO2e
Percent Reduction	1.05	7.84	-17.93	0.00	43.63	77.69	46.52	47.86	76.24	52.54	0.00	0.00	0.00	0.00	0.00	0.00



Green Valley Logistics (Imperial County) - Mitigated - Imperial County, Summer

**EMFAC Off-Model Adjustment Factors for Gasoline Light Duty Vehicle to Account for the SAFE Vehicle Rule Applied**

**2.2 Overall Operational  
Unmitigated Operational**

Category	ROG	NOx	CO	SO2	Fugitive PM10	Exhaust PM10	PM10 Total	Fugitive PM2.5	Exhaust PM2.5	PM2.5 Total	Bio- CO2	NBio- CO2	Total CO2	CH4	N2O	CO2e
lb/day																
Area	26.6059	1.3100e-003	0.1442	1.0000e-005	5.1000e-004	5.1000e-004	5.1000e-004	5.1000e-004	5.1000e-004	5.1000e-004	0.3099	0.3099	0.3099	8.1000e-004	0.0215	0.3301
Energy	0.1073	0.9754	0.8194	5.8500e-003	0.0741	0.0741	0.0741	0.0741	0.0741	0.0741	1,170.4978	1,170.4978	1,170.4978	0.0224	0.0215	1,177.4535
Mobile	0.0341	0.0165	0.3225	8.4000e-004	10.5142	4.3000e-004	10.5146	1.0632	4.0000e-004	1.0636	87.1296	87.1296	87.1296	2.3000e-003	2.3000e-003	87.8724
<b>Total</b>	<b>26.7473</b>	<b>0.9932</b>	<b>1.2860</b>	<b>6.7000e-003</b>	<b>10.5142</b>	<b>0.0751</b>	<b>10.5892</b>	<b>1.0632</b>	<b>0.0750</b>	<b>1.1383</b>	<b>1,257.9373</b>	<b>1,257.9373</b>	<b>1,257.9373</b>	<b>0.0255</b>	<b>0.0238</b>	<b>1,265.6559</b>

**Mitigated Operational**

Category	ROG	NOx	CO	SO2	Fugitive PM10	Exhaust PM10	PM10 Total	Fugitive PM2.5	Exhaust PM2.5	PM2.5 Total	Bio- CO2	NBio- CO2	Total CO2	CH4	N2O	CO2e
lb/day																
Area	26.6059	1.3100e-003	0.1442	1.0000e-005	5.1000e-004	5.1000e-004	5.1000e-004	5.1000e-004	5.1000e-004	5.1000e-004	0.3099	0.3099	0.3099	8.1000e-004	0.0215	0.3301
Energy	0.1073	0.9754	0.8194	5.8500e-003	0.0741	0.0741	0.0741	0.0741	0.0741	0.0741	1,170.4978	1,170.4978	1,170.4978	0.0224	0.0215	1,177.4535
Mobile	0.0341	0.0165	0.3225	8.4000e-004	10.5142	4.3000e-004	10.5146	1.0632	4.0000e-004	1.0636	87.1296	87.1296	87.1296	2.3000e-003	2.3000e-003	87.8724
<b>Total</b>	<b>26.7473</b>	<b>0.9932</b>	<b>1.2860</b>	<b>6.7000e-003</b>	<b>10.5142</b>	<b>0.0751</b>	<b>10.5892</b>	<b>1.0632</b>	<b>0.0750</b>	<b>1.1383</b>	<b>1,257.9373</b>	<b>1,257.9373</b>	<b>1,257.9373</b>	<b>0.0255</b>	<b>0.0238</b>	<b>1,265.6559</b>

EEC ORIGINAL PKG



Green Valley Logistics (Imperial County) - Mitigated - Imperial County, Summer

**EMFAC Off-Model Adjustment Factors for Gasoline Light Duty Vehicle to Account for the SAFE Vehicle Rule Applied**

ROG	NOx	CO	SO2	Fugitive PM10	Exhaust PM10	PM10 Total	Fugitive PM2.5	Exhaust PM2.5	PM2.5 Total	Bio- CO2	NBio-CO2	Total CO2	CH4	N2O	CO2e
0.00	0.00	0.00	0.00	0.00	0.00	0.00	0.00	0.00	0.00	0.00	0.00	0.00	0.00	0.00	0.00

**3.0 Construction Detail**

**Construction Phase**

Phase Number	Phase Name	Phase Type	Start Date	End Date	Num Days Week	Num Days	Phase Description
1	Site Preparation	Site Preparation	1/1/2024	3/1/2024	5	45	
2	Grading	Grading	2/1/2024	4/3/2024	5	45	
3	Building Construction	Building Construction	4/4/2024	6/30/2025	5	323	
4	Paving	Paving	4/4/2024	5/8/2024	5	25	
5	Architectural Coating	Architectural Coating	7/1/2024	5/9/2025	5	225	

**Acres of Grading (Site Preparation Phase): 67.5**

**Acres of Grading (Grading Phase): 135**

**Acres of Paving: 4**

**Residential Indoor: 0; Residential Outdoor: 0; Non-Residential Indoor: 1,578,388; Non-Residential Outdoor: 526,129; Striped Parking Area: 8,400 (Architectural Coating – sqft)**

**Offroad Equipment**

Phase Name	Offroad Equipment Type	Amount	Usage Hours	Horse Power	Load Factor
Site Preparation	Rubber Tired Dozers	3	8.00	247	0.40
Site Preparation	Tractors/Loaders/Backhoes	4	8.00	97	0.37
Grading	Excavators	2	8.00	158	0.38
Grading	Graders	1	8.00	187	0.41
Grading	Rubber Tired Dozers	1	8.00	247	0.40
Grading	Scrapers	2	8.00	367	0.48

Green Valley Logistics (Imperial County) - Mitigated - Imperial County, Summer

**EMFAC Off-Model Adjustment Factors for Gasoline Light Duty Vehicle to Account for the SAFE Vehicle Rule Applied**

Phase Name	Offroad Equipment Count	Worker Trip Number	Vendor Trip Number	Hauling Trip Number	Worker Trip Length	Vendor Trip Length	Hauling Trip Length	Worker Vehicle Class	Vendor Vehicle Class	Hauling Vehicle Class
Grading							8.00	97		0.37
Building Construction							8.00	63		0.31
Building Construction							7.00	231		0.29
Building Construction							8.00	100		0.40
Building Construction							7.00	97		0.37
Building Construction							8.00	46		0.45
Paving							8.00	130		0.42
Paving							8.00	132		0.36
Paving							8.00	80		0.38
Architectural Coating							6.00	78		0.48

**Trips and VMT**

Phase Name	Offroad Equipment Count	Worker Trip Number	Vendor Trip Number	Hauling Trip Number	Worker Trip Length	Vendor Trip Length	Hauling Trip Length	Worker Vehicle Class	Vendor Vehicle Class	Hauling Vehicle Class
Site Preparation	7	18.00	0.00	125.00	7.30	7.30	20.00	LD_Mix	HDT_Mix	HHDT
Grading	8	20.00	0.00	2,965.35	7.30	7.30	20.00	LD_Mix	HDT_Mix	HHDT
Building Construction	10	501.00	195.00	21,284.65	7.30	7.30	20.00	LD_Mix	HDT_Mix	HHDT
Paving	6	15.00	0.00	0.00	7.30	7.30	20.00	LD_Mix	HDT_Mix	HHDT
Architectural Coating	1	100.00	0.00	0.00	7.30	7.30	20.00	LD_Mix	HDT_Mix	HHDT

**3. Mitigation Measures Construction**

- Use Cleaner Engines for Construction Equipment
- Use DPF for Construction Equipment
- Water Exposed Area
- Water Unpaved Roads
- Reduce Vehicle Speed on Unpaved Roads

Green Valley Logistics (Imperial County) - Mitigated - Imperial County, Summer

**EMFAC Off-Model Adjustment Factors for Gasoline Light Duty Vehicle to Account for the SAFE Vehicle Rule Applied**

**3.2 Site Preparation - 2024**

**Unmitigated Construction On-Site**

Category	ROG	NOx	CO	SO2	Fugitive PM10	Exhaust PM10	PM10 Total	Fugitive PM2.5	Exhaust PM2.5	PM2.5 Total	Bio- CO2	NBio- CO2	Total CO2	CH4	N2O	CO2e
lb/day																
Fugitive Dust					19.6614	0.0000	19.6614	10.1031	0.0000	10.1031			0.0000			0.0000
Off-Road	2.6609	27.1760	18.3356	0.0381	1.2294	1.2294	1.2294	1.1310	1.1310	1.1310		3,688.010	3,688.010	1.1928		3,717.829
<b>Total</b>	<b>2.6609</b>	<b>27.1760</b>	<b>18.3356</b>	<b>0.0381</b>	<b>19.6614</b>	<b>1.2294</b>	<b>20.8908</b>	<b>10.1031</b>	<b>1.1310</b>	<b>11.2341</b>		<b>3,688.010</b>	<b>3,688.010</b>	<b>1.1928</b>		<b>3,717.829</b>

**Unmitigated Construction Off-Site**

Category	ROG	NOx	CO	SO2	Fugitive PM10	Exhaust PM10	PM10 Total	Fugitive PM2.5	Exhaust PM2.5	PM2.5 Total	Bio- CO2	NBio- CO2	Total CO2	CH4	N2O	CO2e
lb/day																
Hauling	6.6900e-003	0.2657	0.0802	1.4700e-003	0.0487	3.3800e-003	0.0521	0.0134	3.2300e-003	0.0166		156.2216	156.2216	4.5000e-004	0.0246	163.5508
Vendor	0.0000	0.0000	0.0000	0.0000	0.0000	0.0000	0.0000	0.0000	0.0000	0.0000		0.0000	0.0000	0.0000	0.0000	0.0000
Worker	0.0726	0.0292	0.4433	9.1000e-004	0.1000	5.0000e-004	0.1005	0.0265	4.6000e-004	0.0270		93.9181	93.9181	3.2400e-003	2.8700e-003	94.8555
<b>Total</b>	<b>0.0793</b>	<b>0.2949</b>	<b>0.5234</b>	<b>2.3800e-003</b>	<b>0.1487</b>	<b>3.8800e-003</b>	<b>0.1526</b>	<b>0.0399</b>	<b>3.6900e-003</b>	<b>0.0436</b>		<b>250.1396</b>	<b>250.1396</b>	<b>3.6900e-003</b>	<b>0.0274</b>	<b>258.4063</b>

EEC ORIGINAL PKG

Green Valley Logistics (Imperial County) - Mitigated - Imperial County, Summer

**EMFAC Off-Model Adjustment Factors for Gasoline Light Duty Vehicle to Account for the SAFE Vehicle Rule Applied**

**3.2 Site Preparation - 2024**

**Mitigated Construction On-Site**

Category	ROG	NOx	CO	SO2	Fugitive PM10	Exhaust PM10	PM10 Total	Fugitive PM2.5	Exhaust PM2.5	PM2.5 Total	Bio- CO2	NBio- CO2	Total CO2	CH4	N2O	CO2e
	lb/day															
Fugitive Dust					8.8477	0.0000	8.8477	4.5464	0.0000	4.5464			0.0000			0.0000
Off-Road	0.9312	19.0656	22.9600	0.0381		0.1419	0.1419		0.1419	0.1419	0.0000	3.688,010	3.688,010	1.1928		3,717,829
<b>Total</b>	<b>0.9312</b>	<b>19.0656</b>	<b>22.9600</b>	<b>0.0381</b>	<b>8.8477</b>	<b>0.1419</b>	<b>8.9896</b>	<b>4.5464</b>	<b>0.1419</b>	<b>4.6883</b>	<b>0.0000</b>	<b>3.688,010</b>	<b>3.688,010</b>	<b>1.1928</b>		<b>3,717,829</b>

**Mitigated Construction Off-Site**

Category	ROG	NOx	CO	SO2	Fugitive PM10	Exhaust PM10	PM10 Total	Fugitive PM2.5	Exhaust PM2.5	PM2.5 Total	Bio- CO2	NBio- CO2	Total CO2	CH4	N2O	CO2e
	lb/day															
Hauling	6.6900e-003	0.2657	0.0602	1.4700e-003	0.0487	3.3800e-003	0.0521	0.0134	3.2300e-003	0.0166		156.2216	156.2216	4.5000e-004	0.0246	163.5506
Vendor	0.0000	0.0000	0.0000	0.0000	0.0000	0.0000	0.0000	0.0000	0.0000	0.0000		0.0000	0.0000	0.0000	0.0000	0.0000
Worker	0.0726	0.0292	0.4433	9.1000e-004	0.1000	5.0000e-004	0.1005	0.0265	4.6000e-004	0.0270		93.9181	93.9181	3.2400e-003	2.8700e-003	94.8555
<b>Total</b>	<b>0.0793</b>	<b>0.2949</b>	<b>0.5234</b>	<b>2.3800e-003</b>	<b>0.1487</b>	<b>3.8800e-003</b>	<b>0.1526</b>	<b>0.0399</b>	<b>3.6900e-003</b>	<b>0.0436</b>		<b>250.1396</b>	<b>250.1396</b>	<b>3.6900e-003</b>	<b>0.0274</b>	<b>258.4063</b>

EEC ORIGINAL PKG



Green Valley Logistics (Imperial County) - Mitigated - Imperial County, Summer

**EMFAC Off-Model Adjustment Factors for Gasoline Light Duty Vehicle to Account for the SAFE Vehicle Rule Applied**

**3.3 Grading - 2024**

**Unmitigated Construction On-Site**

Category	ROG	NOx	CO	SO2	Fugitive PM10	Exhaust PM10	PM10 Total	Fugitive PM2.5	Exhaust PM2.5	PM2.5 Total	Bio- CO2	NBio- CO2	Total CO2	CH4	N2O	CO2e
lb/day																
Fugitive Dust					9.2036	0.0000	9.2036	3.6538	0.0000	3.6538			0.0000			0.0000
Off-Road	3.2181	32.3770	27.7228	0.0621		1.3354	1.3354	1.2286	1.2286	1.2286		6,009,748 <sup>7</sup>	6,009,748 <sup>7</sup>	1,9437		6,058,340 <sup>5</sup>
<b>Total</b>	<b>3.2181</b>	<b>32.3770</b>	<b>27.7228</b>	<b>0.0621</b>	<b>9.2036</b>	<b>1.3354</b>	<b>10.5390</b>	<b>3.6538</b>	<b>1.2286</b>	<b>4.8823</b>		<b>6,009,748<sup>7</sup></b>	<b>6,009,748<sup>7</sup></b>	<b>1,9437</b>		<b>6,058,340<sup>5</sup></b>

**Unmitigated Construction Off-Site**

Category	ROG	NOx	CO	SO2	Fugitive PM10	Exhaust PM10	PM10 Total	Fugitive PM2.5	Exhaust PM2.5	PM2.5 Total	Bio- CO2	NBio- CO2	Total CO2	CH4	N2O	CO2e
lb/day																
hauling	0.1587	6.3055	1.9017	0.0350	1.1559	0.0801	1.2360	0.3171	0.0767	0.3938		3,706.824 <sup>8</sup>	3,706.824 <sup>8</sup>	0.0107	0.5827	3,860.732 <sup>2</sup>
Vendor	0.0000	0.0000	0.0000	0.0000	0.0000	0.0000	0.0000	0.0000	0.0000	0.0000		0.0000	0.0000	0.0000	0.0000	0.0000
Worker	0.0807	0.0324	0.4925	1.0100e-003	0.1111	5.5000e-004	0.1117	0.0295	5.1000e-004	0.0300		104.3534	104.3534	3.6000e-003	3.1900e-003	105.3950
<b>Total</b>	<b>0.2394</b>	<b>6.3379</b>	<b>2.3942</b>	<b>0.0360</b>	<b>1.2670</b>	<b>0.0807</b>	<b>1.3477</b>	<b>0.3466</b>	<b>0.0772</b>	<b>0.4238</b>		<b>3,811,178<sup>2</sup></b>	<b>3,811,178<sup>2</sup></b>	<b>0.0143</b>	<b>0.5859</b>	<b>3,986.127<sup>2</sup></b>

EEC ORIGINAL PKG



Green Valley Logistics (Imperial County) - Mitigated - Imperial County, Summer

**EMFAC Off-Model Adjustment Factors for Gasoline Light Duty Vehicle to Account for the SAFE Vehicle Rule Applied**

**3.3 Grading - 2024**

**Mitigated Construction On-Site**

Category	ROG	NOx	CO	SO2	Fugitive PM10	Exhaust PM10	PM10 Total	Fugitive PM2.5	Exhaust PM2.5	PM2.5 Total	Bio- CO2	NBio- CO2	Total CO2	CH4	N2O	CO2e
	lb/day															
Fugitive Dust					4.1416	0.0000	4.1416	1.6442	0.0000	1.6442			0.0000			0.0000
Off-Road	1.5231	29.9782	36.7226	0.0621	0.1949	0.1949	0.1949	0.1949	0.1949	0.1949	0.0000	6,009.748 <sub>7</sub>	6,009.748 <sub>7</sub>	1.9437		6,058.340 <sub>5</sub>
<b>Total</b>	<b>1.5231</b>	<b>29.9782</b>	<b>36.7226</b>	<b>0.0621</b>	<b>4.1416</b>	<b>0.1949</b>	<b>4.3365</b>	<b>1.6442</b>	<b>0.1949</b>	<b>1.8391</b>	<b>0.0000</b>	<b>6,009.748<sub>7</sub></b>	<b>6,009.748<sub>7</sub></b>	<b>1.9437</b>		<b>6,058.340<sub>5</sub></b>

**Mitigated Construction Off-Site**

Category	ROG	NOx	CO	SO2	Fugitive PM10	Exhaust PM10	PM10 Total	Fugitive PM2.5	Exhaust PM2.5	PM2.5 Total	Bio- CO2	NBio- CO2	Total CO2	CH4	N2O	CO2e
	lb/day															
Hauling	0.1587	6.3055	1.9017	0.0350	1.1559	0.0801	1.2360	0.3171	0.0767	0.3938		3,706.824 <sub>8</sub>	3,706.824 <sub>8</sub>	0.0107	0.5827	3,880.732 <sub>2</sub>
Vendor	0.0000	0.0000	0.0000	0.0000	0.0000	0.0000	0.0000	0.0000	0.0000	0.0000		0.0000	0.0000	0.0000	0.0000	0.0000
Worker	0.0807	0.0324	0.4925	1.0100e-003	0.1111	5.5000e-004	0.1117	0.0295	5.7000e-004	0.0300		104.3534	104.3534	3.6000e-003	3.1900e-003	105.3950
<b>Total</b>	<b>0.2394</b>	<b>6.3379</b>	<b>2.3942</b>	<b>0.0360</b>	<b>1.2670</b>	<b>0.0807</b>	<b>1.3477</b>	<b>0.3466</b>	<b>0.0772</b>	<b>0.4238</b>		<b>3,811.178<sub>2</sub></b>	<b>3,811.178<sub>2</sub></b>	<b>0.0143</b>	<b>0.5859</b>	<b>3,986.127<sub>2</sub></b>

EEC ORIGINAL PKG

Green Valley Logistics (Imperial County) - Mitigated - Imperial County, Summer

**EMFAC Off-Model Adjustment Factors for Gasoline Light Duty Vehicle to Account for the SAFE Vehicle Rule Applied**

**3.4 Building Construction - 2024**

**Unmitigated Construction On-Site**

Category	lb/day															
	ROG	NOx	CO	SO2	Fugitive PM10	Exhaust PM10	PM10 Total	Fugitive PM2.5	Exhaust PM2.5	PM2.5 Total	Bio- CO2	NBio- CO2	Total CO2	CH4	N2O	CO2e
Off-Road	1.4882	15.0679	17.4016	0.0311		0.5776	0.5776		0.5352	0.5352		2,970.240 <sub>4</sub>	2,970.240 <sub>4</sub>	0.9147		2,993.108 <sub>1</sub>
<b>Total</b>	<b>1.4882</b>	<b>15.0679</b>	<b>17.4016</b>	<b>0.0311</b>		<b>0.5776</b>	<b>0.5776</b>		<b>0.5352</b>	<b>0.5352</b>		<b>2,970.240<sub>4</sub></b>	<b>2,970.240<sub>4</sub></b>	<b>0.9147</b>		<b>2,993.108<sub>1</sub></b>

**Unmitigated Construction Off-Site**

Category	lb/day															
	ROG	NOx	CO	SO2	Fugitive PM10	Exhaust PM10	PM10 Total	Fugitive PM2.5	Exhaust PM2.5	PM2.5 Total	Bio- CO2	NBio- CO2	Total CO2	CH4	N2O	CO2e
Hauling	0.1587	6.3042	1.9013	0.0350	1.1559	0.0801	1.2360	0.3171	0.0787	0.3958		3,706.078 <sub>1</sub>	3,706.078 <sub>1</sub>	0.0107	0.5826	3,879.950 <sub>4</sub>
Vendor	0.4041	7.3993	3.6202	0.0440	1.6112	0.0719	1.6830	0.4639	0.0687	0.5326		4,625.644 <sub>0</sub>	4,625.644 <sub>0</sub>	0.0207	0.6355	4,815.532 <sub>6</sub>
Worker	2.0211	0.8118	12.3376	0.0253	2.7834	0.0138	2.7972	0.7385	0.0127	0.7512		2,614.052 <sub>5</sub>	2,614.052 <sub>5</sub>	0.0902	0.0800	2,640.144 <sub>9</sub>
<b>Total</b>	<b>2.5839</b>	<b>14.5153</b>	<b>17.8591</b>	<b>0.1043</b>	<b>5.5505</b>	<b>0.1658</b>	<b>5.7162</b>	<b>1.5195</b>	<b>0.1581</b>	<b>1.8776</b>		<b>10,945.77<sub>46</sub></b>	<b>10,945.77<sub>46</sub></b>	<b>0.1216</b>	<b>1.2980</b>	<b>11,335.62<sub>79</sub></b>

EEC ORIGINAL PKG

Green Valley Logistics (Imperial County) - Mitigated - Imperial County, Summer

**EMFAC Off-Model Adjustment Factors for Gasoline Light Duty Vehicle to Account for the SAFE Vehicle Rule Applied**

**3.4 Building Construction - 2024**

**Mitigated Construction On-Site**

Category	ROG	NOx	CO	SO2	Fugitive PM10	Exhaust PM10	PM10 Total	Fugitive PM2.5	Exhaust PM2.5	PM2.5 Total	Bio- CO2	NBio- CO2	Total CO2	CH4	N2O	CO2e
	lb/day															
Off-Road	0.8054	16.7936	20.7901	0.0311		0.1510	0.1510		0.1510	0.1510	0.0000	2,970.240 4	2,970.240 4	0.9147		2,993.108 1
<b>Total</b>	<b>0.8054</b>	<b>16.7936</b>	<b>20.7901</b>	<b>0.0311</b>		<b>0.1510</b>	<b>0.1510</b>		<b>0.1510</b>	<b>0.1510</b>	<b>0.0000</b>	<b>2,970.240 4</b>	<b>2,970.240 4</b>	<b>0.9147</b>		<b>2,993.108 1</b>

**Mitigated Construction Off-Site**

Category	ROG	NOx	CO	SO2	Fugitive PM10	Exhaust PM10	PM10 Total	Fugitive PM2.5	Exhaust PM2.5	PM2.5 Total	Bio- CO2	NBio- CO2	Total CO2	CH4	N2O	CO2e
	lb/day															
Hauling	0.1587	6.3042	1.9013	0.0350	1.1559	0.0801	1.2360	0.3171	0.0767	0.3938		3,706.078 1	3,706.078 1	0.0107	0.5826	3,879.950 4
Vendor	0.4041	7.3993	3.6202	0.0440	1.6112	0.0719	1.6830	0.4639	0.0687	0.5326		4,625.644 0	4,625.644 0	0.0207	0.6355	4,815.532 6
Worker	2.0211	0.8118	12.3376	0.0253	2.7834	0.0138	2.7972	0.7385	0.0127	0.7512		2,614.052 5	2,614.052 5	0.0902	0.0800	2,640.144 9
<b>Total</b>	<b>2.5839</b>	<b>14.5153</b>	<b>17.8591</b>	<b>0.1043</b>	<b>5.5505</b>	<b>0.1658</b>	<b>5.7162</b>	<b>1.5195</b>	<b>0.1581</b>	<b>1.6776</b>		<b>10,945.777 46</b>	<b>10,945.777 46</b>	<b>0.1216</b>	<b>1.2980</b>	<b>11,335.6279</b>

EEC ORIGINAL PKG

Green Valley Logistics (Imperial County) - Mitigated - Imperial County, Summer

**EMFAC Off-Model Adjustment Factors for Gasoline Light Duty Vehicle to Account for the SAFE Vehicle Rule Applied**

**3.4 Building Construction - 2025**

**Unmitigated Construction On-Site**

Category	ROG	NOx	CO	SO2	Fugitive PM10	Exhaust PM10	PM10 Total	Fugitive PM2.5	Exhaust PM2.5	PM2.5 Total	Bio- CO2	NBio- CO2	Total CO2	CH4	N2O	CO2e
lb/day																
Off-Road	1.3760	14.0000	17.2964	0.0311		0.5085	0.5085		0.4711	0.4711		2,970.995	2,970.995	0.9135		2,993.832
Total	1.3760	14.0000	17.2964	0.0311		0.5085	0.5085		0.4711	0.4711		2,970.995	2,970.995	0.9135		2,993.832

**Unmitigated Construction Off-Site**

Category	ROG	NOx	CO	SO2	Fugitive PM10	Exhaust PM10	PM10 Total	Fugitive PM2.5	Exhaust PM2.5	PM2.5 Total	Bio- CO2	NBio- CO2	Total CO2	CH4	N2O	CO2e
lb/day																
Hauling	0.1586	6.2224	1.9050	0.0342	1.1559	0.0796	1.2355	0.3171	0.0762	0.3933		3,620.702	3,620.702	0.0110	0.5692	3,790.583
Vendor	0.3928	7.2977	3.5149	0.0432	1.6112	0.0715	1.6827	0.4639	0.0684	0.5323		4,545.380	4,545.380	0.0203	0.6206	4,730.815
Worker	1.8774	0.7272	11.4064	0.0245	2.7834	0.0130	2.7965	0.7385	0.0120	0.7505		2,549.362	2,549.362	0.0813	0.0744	2,573.575
Total	2.4288	14.2473	16.8263	0.1019	5.5505	0.1641	5.7146	1.5195	0.1565	1.6760		10,715.44	10,715.44	0.1126	1.2641	11,094.97
												59	59			43

EEC ORIGINAL PKG



Green Valley Logistics (Imperial County) - Mitigated - Imperial County, Summer

**EMFAC Off-Model Adjustment Factors for Gasoline Light Duty Vehicle to Account for the SAFE Vehicle Rule Applied**

**3.4 Building Construction - 2025**

**Mitigated Construction On-Site**

Category	lb/day															
	ROG	NOx	CO	SO2	Fugitive PM10	Exhaust PM10	PM10 Total	Fugitive PM2.5	Exhaust PM2.5	PM2.5 Total	Bio- CO2	NBio- CO2	Total CO2	CH4	N2O	CO2e
Off-Road	0.8054	16.7936	20.7901	0.0311	0.1510	0.1510	0.1510	0.1510	0.1510	0.1510	0.0000	2,970.9950	2,970.9950	0.9135		2,993.8323
<b>Total</b>	<b>0.8054</b>	<b>16.7936</b>	<b>20.7901</b>	<b>0.0311</b>		<b>0.1510</b>	<b>0.1510</b>		<b>0.1510</b>	<b>0.1510</b>	<b>0.0000</b>	<b>2,970.9950</b>	<b>2,970.9950</b>	<b>0.9135</b>		<b>2,993.8323</b>

**Mitigated Construction Off-Site**

Category	lb/day															
	ROG	NOx	CO	SO2	Fugitive PM10	Exhaust PM10	PM10 Total	Fugitive PM2.5	Exhaust PM2.5	PM2.5 Total	Bio- CO2	NBio- CO2	Total CO2	CH4	N2O	CO2e
Hauling	0.1586	6.2224	1.9050	0.0342	1.1559	0.0796	1.2355	0.3171	0.0762	0.3933		3,620.7023	3,620.7023	0.0110	0.5692	3,790.5888
Vendor	0.3928	7.2977	3.5149	0.0432	1.6112	0.0715	1.6827	0.4639	0.0684	0.5323		4,545.3807	4,545.3807	0.0203	0.6206	4,730.8152
Worker	1.8774	0.7272	11.4064	0.0245	2.7834	0.0130	2.7965	0.7385	0.0120	0.7505		2,549.3629	2,549.3629	0.0813	0.0744	2,573.5753
<b>Total</b>	<b>2.4288</b>	<b>14.2473</b>	<b>16.8263</b>	<b>0.1019</b>	<b>5.5505</b>	<b>0.1641</b>	<b>5.7146</b>	<b>1.5195</b>	<b>0.1565</b>	<b>1.6760</b>		<b>10,715.4459</b>	<b>10,715.4459</b>	<b>0.1126</b>	<b>1.2641</b>	<b>11,094.9743</b>

EEC ORIGINAL PKG



Green Valley Logistics (Imperial County) - Mitigated - Imperial County, Summer

**EMFAC Off-Model Adjustment Factors for Gasoline Light Duty Vehicle to Account for the SAFE Vehicle Rule Applied**

**3.5 Paving - 2024**

**Unmitigated Construction On-Site**

Category	lb/day															
	ROG	NOx	CO	SO2	Fugitive PM10	Exhaust PM10	PM10 Total	Fugitive PM2.5	Exhaust PM2.5	PM2.5 Total	Bio- CO2	NBio- CO2	Total CO2	CH4	N2O	CO2e
Off-Road	0.9882	9.5246	14.6258	0.0228	0.4685	0.4685	0.4685	0.4310	0.4310	0.4310	2,207.547 <sub>2</sub>	2,207.547 <sub>2</sub>	2,207.547 <sub>2</sub>	0.7140	0.7140	2,225.396 <sub>3</sub>
Paving	0.4192				0.0000	0.0000	0.0000	0.0000	0.0000	0.0000			0.0000			0.0000
<b>Total</b>	<b>1.4074</b>	<b>9.5246</b>	<b>14.6258</b>	<b>0.0228</b>	<b>0.4685</b>	<b>0.4685</b>	<b>0.4685</b>	<b>0.4310</b>	<b>0.4310</b>	<b>0.4310</b>	<b>2,207.547<sub>2</sub></b>	<b>2,207.547<sub>2</sub></b>	<b>2,207.547<sub>2</sub></b>	<b>0.7140</b>	<b>0.7140</b>	<b>2,225.396<sub>3</sub></b>

**Unmitigated Construction Off-Site**

Category	lb/day															
	ROG	NOx	CO	SO2	Fugitive PM10	Exhaust PM10	PM10 Total	Fugitive PM2.5	Exhaust PM2.5	PM2.5 Total	Bio- CO2	NBio- CO2	Total CO2	CH4	N2O	CO2e
Hauling	0.0000	0.0000	0.0000	0.0000	0.0000	0.0000	0.0000	0.0000	0.0000	0.0000	0.0000	0.0000	0.0000	0.0000	0.0000	0.0000
Vendor	0.0000	0.0000	0.0000	0.0000	0.0000	0.0000	0.0000	0.0000	0.0000	0.0000	0.0000	0.0000	0.0000	0.0000	0.0000	0.0000
Worker	0.0605	0.0243	0.3694	7.6000e-004	0.0833	4.1000e-004	0.0838	0.0221	3.8000e-004	0.0225	78.2651	78.2651	78.2651	2.7000e-003	2.3900e-003	79.0463
<b>Total</b>	<b>0.0605</b>	<b>0.0243</b>	<b>0.3694</b>	<b>7.6000e-004</b>	<b>0.0833</b>	<b>4.1000e-004</b>	<b>0.0838</b>	<b>0.0221</b>	<b>3.8000e-004</b>	<b>0.0225</b>	<b>78.2651</b>	<b>78.2651</b>	<b>78.2651</b>	<b>2.7000e-003</b>	<b>2.3900e-003</b>	<b>79.0463</b>

EEC ORIGINAL PKG

Green Valley Logistics (Imperial County) - Mitigated - Imperial County, Summer

**EMFAC Off-Model Adjustment Factors for Gasoline Light Duty Vehicle to Account for the SAFE Vehicle Rule Applied**

**3.5 Paving - 2024**

**Mitigated Construction On-Site**

Category	ROG	NOx	CO	SO2	Fugitive PM10	Exhaust PM10	PM10 Total	Fugitive PM2.5	Exhaust PM2.5	PM2.5 Total	Bio- CO2	NBio- CO2	Total CO2	CH4	N2O	CO2e
lb/day																
Off-Road	0.5609	11.2952	17.2957	0.0228	0.0914	0.0914	0.0914	0.0914	0.0914	0.0914	0.0000	2,207.547 2	2,207.547 2	0.7140		2,225.396 3
Paving	0.4192				0.0000	0.0000	0.0000	0.0000	0.0000	0.0000			0.0000			0.0000
<b>Total</b>	<b>0.9801</b>	<b>11.2952</b>	<b>17.2957</b>	<b>0.0228</b>	<b>0.0914</b>	<b>0.0914</b>	<b>0.0914</b>	<b>0.0914</b>	<b>0.0914</b>	<b>0.0914</b>	<b>0.0000</b>	<b>2,207.547 2</b>	<b>2,207.547 2</b>	<b>0.7140</b>		<b>2,225.396 3</b>

**Mitigated Construction Off-Site**

Category	ROG	NOx	CO	SO2	Fugitive PM10	Exhaust PM10	PM10 Total	Fugitive PM2.5	Exhaust PM2.5	PM2.5 Total	Bio- CO2	NBio- CO2	Total CO2	CH4	N2O	CO2e
lb/day																
Hauling	0.0000	0.0000	0.0000	0.0000	0.0000	0.0000	0.0000	0.0000	0.0000	0.0000			0.0000	0.0000	0.0000	0.0000
Vendor	0.0000	0.0000	0.0000	0.0000	0.0000	0.0000	0.0000	0.0000	0.0000	0.0000			0.0000	0.0000	0.0000	0.0000
Worker	0.0605	0.0243	0.3694	7.6000e-004	0.0633	4.1000e-004	0.0638	0.0221	3.8000e-004	0.0225			78.2651	2.7000e-003	2.3900e-003	79.0463
<b>Total</b>	<b>0.0605</b>	<b>0.0243</b>	<b>0.3694</b>	<b>7.6000e-004</b>	<b>0.0633</b>	<b>4.1000e-004</b>	<b>0.0638</b>	<b>0.0221</b>	<b>3.8000e-004</b>	<b>0.0225</b>			<b>78.2651</b>	<b>2.7000e-003</b>	<b>2.3900e-003</b>	<b>79.0463</b>

EEC ORIGINAL PKG

Green Valley Logistics (Imperial County) - Mitigated - Imperial County, Summer

**EMFAC Off-Model Adjustment Factors for Gasoline Light Duty Vehicle to Account for the SAFE Vehicle Rule Applied**

**3.6 Architectural Coating - 2024**

**Unmitigated Construction On-Site**

Category	ROG	NOx	CO	SO2	Fugitive PM10	Exhaust PM10	PM10 Total	Fugitive PM2.5	Exhaust PM2.5	PM2.5 Total	Bio- CO2	NBio- CO2	Total CO2	CH4	N2O	CO2e
lb/day																
Archit. Coating	65.2881					0.0000	0.0000		0.0000	0.0000			0.0000			0.0000
Off-Road	0.1808	1.2188	1.8101	2.9700e-003		0.0609	0.0609		0.0609	0.0609		281.4481	281.4481	0.0159		281.8443
<b>Total</b>	<b>65.4699</b>	<b>1.2188</b>	<b>1.8101</b>	<b>2.9700e-003</b>		<b>0.0609</b>	<b>0.0609</b>		<b>0.0609</b>	<b>0.0609</b>		<b>281.4481</b>	<b>281.4481</b>	<b>0.0159</b>		<b>281.8443</b>

**Unmitigated Construction Off-Site**

Category	ROG	NOx	CO	SO2	Fugitive PM10	Exhaust PM10	PM10 Total	Fugitive PM2.5	Exhaust PM2.5	PM2.5 Total	Bio- CO2	NBio- CO2	Total CO2	CH4	N2O	CO2e
lb/day																
Hauling	0.0000	0.0000	0.0000	0.0000	0.0000	0.0000	0.0000	0.0000	0.0000	0.0000			0.0000	0.0000	0.0000	0.0000
Vendor	0.0000	0.0000	0.0000	0.0000	0.0000	0.0000	0.0000	0.0000	0.0000	0.0000			0.0000	0.0000	0.0000	0.0000
Worker	0.4034	0.1620	2.4626	5.0600e-003	0.5556	2.7500e-003	0.5583	0.1474	2.5400e-003	0.1499		521.7670	521.7670	0.0180	0.0160	526.9750
<b>Total</b>	<b>0.4034</b>	<b>0.1620</b>	<b>2.4626</b>	<b>5.0600e-003</b>	<b>0.5556</b>	<b>2.7500e-003</b>	<b>0.5583</b>	<b>0.1474</b>	<b>2.5400e-003</b>	<b>0.1499</b>		<b>521.7670</b>	<b>521.7670</b>	<b>0.0180</b>	<b>0.0160</b>	<b>526.9750</b>

REC ORIGINAL PKG

Green Valley Logistics (Imperial County) - Mitigated - Imperial County, Summer

**EMFAC Off-Model Adjustment Factors for Gasoline Light Duty Vehicle to Account for the SAFE Vehicle Rule Applied**

**3.6 Architectural Coating - 2024**

**Mitigated Construction On-Site**

Category	lb/day																
	ROG	NOx	CO	SO2	Fugitive PM10	Exhaust PM10	PM10 Total	Fugitive PM2.5	Exhaust PM2.5	PM2.5 Total	Bio- CO2	NBio- CO2	Total CO2	CH4	N2O	CO2e	
Archit. Coating	65.2891					0.0000	0.0000		0.0000	0.0000			0.0000				0.0000
Off-Road	0.0594	1.3570	1.8324	2.9700e-003	0.0143	0.0143	0.0143	0.0143	0.0143	0.0143	0.0000	281.4481	281.4481	0.0159			281.8443
<b>Total</b>	<b>65.3486</b>	<b>1.3570</b>	<b>1.8324</b>	<b>2.9700e-003</b>	<b>0.0143</b>	<b>0.0143</b>	<b>0.0143</b>	<b>0.0143</b>	<b>0.0143</b>	<b>0.0143</b>	<b>0.0000</b>	<b>281.4481</b>	<b>281.4481</b>	<b>0.0159</b>			<b>281.8443</b>

**Mitigated Construction Off-Site**

Category	lb/day																
	ROG	NOx	CO	SO2	Fugitive PM10	Exhaust PM10	PM10 Total	Fugitive PM2.5	Exhaust PM2.5	PM2.5 Total	Bio- CO2	NBio- CO2	Total CO2	CH4	N2O	CO2e	
Hauling	0.0000	0.0000	0.0000	0.0000	0.0000	0.0000	0.0000	0.0000	0.0000	0.0000			0.0000	0.0000			0.0000
Vendor	0.0000	0.0000	0.0000	0.0000	0.0000	0.0000	0.0000	0.0000	0.0000	0.0000			0.0000	0.0000			0.0000
Worker	0.4034	0.1620	2.4626	5.0600e-003	0.5556	2.7500e-003	0.5583	0.1474	2.5400e-003	0.1499			521.7670	0.0180	0.0160		526.9750
<b>Total</b>	<b>0.4034</b>	<b>0.1620</b>	<b>2.4626</b>	<b>5.0600e-003</b>	<b>0.5556</b>	<b>2.7500e-003</b>	<b>0.5583</b>	<b>0.1474</b>	<b>2.5400e-003</b>	<b>0.1499</b>			<b>521.7670</b>	<b>0.0180</b>	<b>0.0160</b>		<b>526.9750</b>

EEC ORIGINAL PKG



Green Valley Logistics (Imperial County) - Mitigated - Imperial County, Summer

**EMFAC Off-Model Adjustment Factors for Gasoline Light Duty Vehicle to Account for the SAFE Vehicle Rule Applied**

**3.6 Architectural Coating - 2025**

**Unmitigated Construction On-Site**

Category	ROG	NOx	CO	SO2	Fugitive PM10	Exhaust PM10	PM10 Total	Fugitive PM2.5	Exhaust PM2.5	PM2.5 Total	Bio- CO2	NBio- CO2	Total CO2	CH4	N2O	CO2e
lb/day																
Archit. Coating	65.2891					0.0000	0.0000		0.0000	0.0000			0.0000			0.0000
Off-Road	0.1709	1.1455	1.8091	2.9700e-003		0.0515	0.0515		0.0515	0.0515		281.4481	281.4481	0.0154		281.8319
<b>Total</b>	<b>65.4600</b>	<b>1.1455</b>	<b>1.8091</b>	<b>2.9700e-003</b>		<b>0.0515</b>	<b>0.0515</b>		<b>0.0515</b>	<b>0.0515</b>		<b>281.4481</b>	<b>281.4481</b>	<b>0.0154</b>		<b>281.8319</b>

**Unmitigated Construction Off-Site**

Category	ROG	NOx	CO	SO2	Fugitive PM10	Exhaust PM10	PM10 Total	Fugitive PM2.5	Exhaust PM2.5	PM2.5 Total	Bio- CO2	NBio- CO2	Total CO2	CH4	N2O	CO2e
lb/day																
Hauling	0.0000	0.0000	0.0000	0.0000	0.0000	0.0000	0.0000	0.0000	0.0000	0.0000			0.0000	0.0000	0.0000	0.0000
Vendor	0.0000	0.0000	0.0000	0.0000	0.0000	0.0000	0.0000	0.0000	0.0000	0.0000			0.0000	0.0000	0.0000	0.0000
Worker	0.3747	0.1452	2.2767	4.8800e-003	0.5556	2.6000e-003	0.5582	0.1474	2.3900e-003	0.1498		508.8549	508.8549	0.0162	0.0149	513.6877
<b>Total</b>	<b>0.3747</b>	<b>0.1452</b>	<b>2.2767</b>	<b>4.8800e-003</b>	<b>0.5556</b>	<b>2.6000e-003</b>	<b>0.5582</b>	<b>0.1474</b>	<b>2.3900e-003</b>	<b>0.1498</b>		<b>508.8549</b>	<b>508.8549</b>	<b>0.0162</b>	<b>0.0149</b>	<b>513.6877</b>

EEC ORIGINAL PKG



Green Valley Logistics (Imperial County) - Mitigated - Imperial County, Summer

**EMFAC Off-Model Adjustment Factors for Gasoline Light Duty Vehicle to Account for the SAFE Vehicle Rule Applied**

**3.6 Architectural Coating - 2025**

**Mitigated Construction On-Site**

Category	ROG	NOx	CO	SO2	Fugitive PM10	Exhaust PM10	PM10 Total	Fugitive PM2.5	Exhaust PM2.5	PM2.5 Total	Bio- CO2	NBio- CO2	Total CO2	CH4	N2O	CO2e
	lb/day															
Archit. Coating	65.2891					0.0000	0.0000		0.0000	0.0000			0.0000			0.0000
Off-Road	0.0594	1.3570	1.8324	2.9700e-003		0.0143	0.0143		0.0143	0.0143	0.0000	281.4481	281.4481	0.0154		281.8319
<b>Total</b>	<b>65.3486</b>	<b>1.3570</b>	<b>1.8324</b>	<b>2.9700e-003</b>		<b>0.0143</b>	<b>0.0143</b>		<b>0.0143</b>	<b>0.0143</b>	<b>0.0000</b>	<b>281.4481</b>	<b>281.4481</b>	<b>0.0154</b>		<b>281.8319</b>

**Mitigated Construction Off-Site**

Category	ROG	NOx	CO	SO2	Fugitive PM10	Exhaust PM10	PM10 Total	Fugitive PM2.5	Exhaust PM2.5	PM2.5 Total	Bio- CO2	NBio- CO2	Total CO2	CH4	N2O	CO2e
	lb/day															
Hauling	0.0000	0.0000	0.0000	0.0000	0.0000	0.0000	0.0000	0.0000	0.0000	0.0000			0.0000	0.0000		0.0000
Vendor	0.0000	0.0000	0.0000	0.0000	0.0000	0.0000	0.0000	0.0000	0.0000	0.0000			0.0000	0.0000		0.0000
Worker	0.3747	0.1452	2.2767	4.8800e-003	0.5556	2.6000e-003	0.5582	0.1474	2.3900e-003	0.1498			508.8549	0.0162	0.0149	513.6877
<b>Total</b>	<b>0.3747</b>	<b>0.1452</b>	<b>2.2767</b>	<b>4.8800e-003</b>	<b>0.5556</b>	<b>2.6000e-003</b>	<b>0.5582</b>	<b>0.1474</b>	<b>2.3900e-003</b>	<b>0.1498</b>			<b>508.8549</b>	<b>0.0162</b>	<b>0.0149</b>	<b>513.6877</b>

EEC ORIGINAL PKG

Green Valley Logistics (Imperial County) - Mitigated - Imperial County, Summer

**EMFAC Off-Model Adjustment Factors for Gasoline Light Duty Vehicle to Account for the SAFE Vehicle Rule Applied**

**4.0 Operational Detail - Mobile**

**4.1 Mitigation Measures Mobile**

Category	lb/day															
	ROG	NOx	CO	SO2	Fugitive PM10	Exhaust PM10	PM10 Total	Fugitive PM2.5	Exhaust PM2.5	PM2.5 Total	Bio- CO2	NBio- CO2	Total CO2	CH4	N2O	CO2e
Mitigated	0.0341	0.0165	0.3225	8.4000e-004	10.5142	4.3000e-004	10.5146	1.0632	4.0000e-004	1.0636	87.1296	87.1296	87.1296	2.3000e-003	2.3000e-003	87.8724
Unmitigated	0.0341	0.0165	0.3225	8.4000e-004	10.5142	4.3000e-004	10.5146	1.0632	4.0000e-004	1.0636	87.1296	87.1296	87.1296	2.3000e-003	2.3000e-003	87.8724

**4.2 Trip Summary Information**

Land Use	Average Daily Trip Rate			Unmitigated Annual VMT		Mitigated Annual VMT	
	Weekday	Saturday	Sunday	Annual VMT	Annual VMT	Annual VMT	Annual VMT
Convenience Market with Gas Pumps	0.00	0.00	0.00				
General Heavy Industry	21.50	21.50	21.50	50,947	50,947	50,947	50,947
Parking Lot	0.00	0.00	0.00				
Unrefrigerated Warehouse-Rail	0.00	0.00	0.00				
<b>Total</b>	<b>21.50</b>	<b>21.50</b>	<b>21.50</b>	<b>50,947</b>	<b>50,947</b>	<b>50,947</b>	<b>50,947</b>

**4.3 Trip Type Information**

Land Use	Miles					Trip %			Trip Purpose %		
	H-W or C-W	H-S or C-C	H-O or C-NW	H-W or C-W	H-S or C-C	H-O or C-C	H-S or C-C	H-O or C-NW	Primary	Diverted	Pass-by
Convenience Market with Gas	6.70	5.00	8.90	0.80	80.20	19.00	0	0	0	0	0
General Heavy Industry	6.70	5.00	8.90	59.00	28.00	13.00	100	0	0	0	0
Parking Lot	6.70	5.00	8.90	0.00	0.00	0.00	0	0	0	0	0

Green Valley Logistics (Imperial County) - Mitigated - Imperial County, Summer

**EMFAC Off-Model Adjustment Factors for Gasoline Light Duty Vehicle to Account for the SAFE Vehicle Rule Applied**

Land Use	Miles				Trip %				Trip Purpose %			
	H-W or C-W	H-S or C-C	H-O or C-NW	H-W or C-W	H-S or C-C	H-O or C-NW	H-W or C-W	H-S or C-C	H-O or C-NW	Primary	Diverted	Pass-by
Unrefrigerated Warehouse-Rail	6.70	5.00	8.90	59.00	0.00	41.00	0	0	0	0	0	0

**4.4 Fleet Mix**

Land Use	LDA	LDT1	LDT2	MDV	LHD1	LHD2	MHD	HHD	OBUS	UBUS	MCY	SBUS	MH
Convenience Market with Gas Pumps	0.530702	0.059328	0.179664	0.144474	0.026250	0.006790	0.008325	0.016302	0.000941	0.000118	0.022966	0.000752	0.003388
General Heavy Industry	1.000000	0.000000	0.000000	0.000000	0.000000	0.000000	0.000000	0.000000	0.000000	0.000000	0.000000	0.000000	0.000000
Parking Lot	0.530702	0.059328	0.179664	0.144474	0.026250	0.006790	0.008325	0.016302	0.000941	0.000118	0.022966	0.000752	0.003388
Unrefrigerated Warehouse-Rail	0.530702	0.059328	0.179664	0.144474	0.026250	0.006790	0.008325	0.016302	0.000941	0.000118	0.022966	0.000752	0.003388

**5.0 Energy Detail**

Historical Energy Use: N

**5.1 Mitigation Measures Energy**

Category	ROG	NOx	CO	SO2	Fugitive PM10	Exhaust PM10	PM10 Total	Fugitive PM2.5	Exhaust PM2.5	PM2.5 Total	Bio- CO2	NBio- CO2	Total CO2	CH4	N2O	CO2e
Natural Gas Mitigated	0.1073	0.9754	0.8194	5.8500e-003	0.0741	0.0741	0.0741	0.0741	0.0741	0.0741	1,170.4978	1,170.4978	1,170.4978	0.0224	0.0215	1,177.4535
Natural Gas Unmitigated	0.1073	0.9754	0.8194	5.8500e-003	0.0741	0.0741	0.0741	0.0741	0.0741	0.0741	1,170.4978	1,170.4978	1,170.4978	0.0224	0.0215	1,177.4535

EFC ORG TAPK

**EMFAC Off-Model Adjustment Factors for Gasoline Light Duty Vehicle to Account for the SAFE Vehicle Rule Applied**

**5.2 Energy by Land Use - NaturalGas**

Unmitigated

Land Use	NaturalGas Use kBTU/yr	lb/day										lb/day					
		ROG	NOx	CO	SO2	Fugitive PM10	Exhaust PM10	PM10 Total	Fugitive PM2.5	Exhaust PM2.5	PM2.5 Total	Bio- CO2	NBio- CO2	Total CO2	CH4	N2O	CO2e
Convenience Market with Gas Pumps	13.6147	1.5000e-004	1.3300e-003	1.1200e-003	1.0000e-005		1.0000e-004	1.0000e-004		1.0000e-004	1.0000e-004		1.6017	1.6017	3.0000e-005	3.0000e-005	1.6113
General Heavy Industry	4428.77	0.0478	0.4342	0.3647	2.6100e-003		0.0330	0.0330		0.0330	0.0330		521.0314	521.0314	9.9900e-003	9.5500e-003	524.1277
Parking Lot	0	0.0000	0.0000	0.0000	0.0000		0.0000	0.0000		0.0000	0.0000		0.0000	0.0000	0.0000	0.0000	0.0000
Unrefrigerated Warehouse-Rail	5506.85	0.0594	0.5399	0.4535	3.2400e-003		0.0410	0.0410		0.0410	0.0410		647.8646	647.8646	0.0124	0.0119	651.7146
<b>Total</b>		<b>0.1073</b>	<b>0.9754</b>	<b>0.8194</b>	<b>5.8600e-003</b>		<b>0.0741</b>	<b>0.0741</b>		<b>0.0741</b>	<b>0.0741</b>		<b>1,170.4978</b>	<b>1,170.4978</b>	<b>0.0224</b>	<b>0.0215</b>	<b>1,177.4535</b>



Green Valley Logistics (Imperial County) - Mitigated - Imperial County, Summer

**EMFAC Off-Model Adjustment Factors for Gasoline Light Duty Vehicle to Account for the SAFE Vehicle Rule Applied**

**5.2 Energy by Land Use - Natural Gas**

**Mitigated**

Land Use	Natural Gas Use kBtu/yr	lb/day										lb/day				
		NOx	CO	SO2	Fugitive PM10	Exhaust PM10	PM10 Total	Fugitive PM2.5	Exhaust PM2.5	PM2.5 Total	Bio- CO2	NBio- CO2	Total CO2	CH4	N2O	CO2e
Convenience Market with Gas Pumps	0.0136147	1.3300e-003	1.1200e-003	1.0000e-005	1.0000e-004	1.0000e-004	1.0000e-004	1.0000e-004	1.0000e-004	1.0000e-004	1.6017	1.6017	1.6017	3.0000e-005	3.0000e-005	1.6113
General Heavy Industry	4.42877	0.4342	0.3647	2.6100e-003	0.0330	0.0330	0.0330	0.0330	0.0330	0.0330	521.0314	521.0314	9.9900e-003	9.9900e-003	9.5500e-003	524.1277
Parking Lot	0	0.0000	0.0000	0.0000	0.0000	0.0000	0.0000	0.0000	0.0000	0.0000	0.0000	0.0000	0.0000	0.0000	0.0000	0.0000
Unrefrigerated Warehouse-Rail	5.50685	0.5389	0.4535	3.2400e-003	0.0410	0.0410	0.0410	0.0410	0.0410	0.0410	647.8646	647.8646	0.0124	0.0119	0.0119	651.7146
<b>Total</b>		<b>0.1073</b>	<b>0.9754</b>	<b>5.8600e-003</b>	<b>0.0741</b>	<b>0.0741</b>	<b>0.0741</b>	<b>0.0741</b>	<b>0.0741</b>	<b>0.0741</b>	<b>1,170.4978</b>	<b>1,170.4978</b>	<b>0.0224</b>	<b>0.0215</b>	<b>0.0215</b>	<b>1,177.4535</b>

**6.0 Area Detail**

**6.1 Mitigation Measures Area**

Green Valley Logistics (Imperial County) - Mitigated - Imperial County, Summer

**EMFAC Off-Model Adjustment Factors for Gasoline Light Duty Vehicle to Account for the SAFE Vehicle Rule Applied**

Category	ROG	NOx	CO	SO2	Fugitive PM10	Exhaust PM10	PM10 Total	Fugitive PM2.5	Exhaust PM2.5	PM2.5 Total	Bio- CO2	NBio- CO2	Total CO2	CH4	N2O	CO2e
	lb/day															
Mitigated	26.6059	1.3100e-003	0.1442	1.0000e-005		5.1000e-004	5.1000e-004		5.1000e-004	5.1000e-004		0.3099	0.3099	8.1000e-004		0.3301
Unmitigated	26.6059	1.3100e-003	0.1442	1.0000e-005		5.1000e-004	5.1000e-004		5.1000e-004	5.1000e-004		0.3099	0.3099	8.1000e-004		0.3301

**6.2 Area by SubCategory**

**Unmitigated**

SubCategory	ROG	NOx	CO	SO2	Fugitive PM10	Exhaust PM10	PM10 Total	Fugitive PM2.5	Exhaust PM2.5	PM2.5 Total	Bio- CO2	NBio- CO2	Total CO2	CH4	N2O	CO2e
	lb/day															
Architectural Coating	4.0247					0.0000	0.0000		0.0000	0.0000			0.0000			0.0000
Consumer Products	22.5679					0.0000	0.0000		0.0000	0.0000			0.0000			0.0000
Landscaping	0.0133	1.3100e-003	0.1442	1.0000e-005		5.1000e-004	5.1000e-004		5.1000e-004	5.1000e-004		0.3099	0.3099	8.1000e-004		0.3301
<b>Total</b>	<b>26.6059</b>	<b>1.3100e-003</b>	<b>0.1442</b>	<b>1.0000e-005</b>		<b>5.1000e-004</b>	<b>5.1000e-004</b>		<b>5.1000e-004</b>	<b>5.1000e-004</b>		<b>0.3099</b>	<b>0.3099</b>	<b>8.1000e-004</b>		<b>0.3301</b>

EEO ORIGINAL PKG

Green Valley Logistics (Imperial County) - Mitigated - Imperial County, Summer

**EMFAC Off-Model Adjustment Factors for Gasoline Light Duty Vehicle to Account for the SAFE Vehicle Rule Applied**

**6.2 Area by SubCategory**

**Mitigated**

SubCategory	ROG	NOx	CO	SO2	Fugitive PM10	Exhaust PM10	PM10 Total	Fugitive PM2.5	Exhaust PM2.5	PM2.5 Total	Bio- CO2	NBio- CO2	Total CO2	CH4	N2O	CO2e
	lb/day															
Architectural Coating	4.0247					0.0000	0.0000		0.0000	0.0000			0.0000			0.0000
Consumer Products	22.5679					0.0000	0.0000		0.0000	0.0000			0.0000			0.0000
Landscaping	0.0133	1.3100e-003	0.1442	1.0000e-005		5.1000e-004	5.1000e-004		5.1000e-004	5.1000e-004		0.3099	0.3099	8.1000e-004		0.3301
<b>Total</b>	<b>26.6059</b>	<b>1.3100e-003</b>	<b>0.1442</b>	<b>1.0000e-005</b>		<b>5.1000e-004</b>	<b>5.1000e-004</b>		<b>5.1000e-004</b>	<b>5.1000e-004</b>		<b>0.3099</b>	<b>0.3099</b>	<b>8.1000e-004</b>		<b>0.3301</b>

**7.0 Water Detail**

**7.1 Mitigation Measures Water**

Green Valley Logistics (Imperial County) - Mitigated - Imperial County, Summer

**EMFAC Off-Model Adjustment Factors for Gasoline Light Duty Vehicle to Account for the SAFE Vehicle Rule Applied**

**8.0 Waste Detail**

---

**8.1 Mitigation Measures Waste**

**9.0 Operational Offroad**

---

Equipment Type	Number	Hours/Day	Days/Year	Horse Power	Load Factor	Fuel Type
----------------	--------	-----------	-----------	-------------	-------------	-----------

**10.0 Stationary Equipment**

---

**Fire Pumps and Emergency Generators**

Equipment Type	Number	Hours/Day	Hours/Year	Horse Power	Load Factor	Fuel Type
----------------	--------	-----------	------------	-------------	-------------	-----------

**Boilers**

Equipment Type	Number	Heat Input/Day	Heat Input/Year	Boiler Rating	Fuel Type
----------------	--------	----------------	-----------------	---------------	-----------

**User Defined Equipment**

Equipment Type	Number
----------------	--------

**11.0 Vegetation**

---



Green Valley Logistics (Imperial County) - Mitigated - Imperial County, Winter

**EMFAC Off-Model Adjustment Factors for Gasoline Light Duty Vehicle to Account for the SAFE Vehicle Rule Applied**

**Green Valley Logistics (Imperial County) - Mitigated**

Imperial County, Winter

**1.0 Project Characteristics**

**1.1 Land Usage**

Land Uses	Size	Metric	Lot Acreage	Floor Surface Area	Population
General Heavy Industry	50.00	1000sqft	207.00	50,000.00	0
Unrefrigerated Warehouse-Rail	1,000.00	1000sqft	64.00	1,000,000.00	0
Parking Lot	350.00	Space	4.00	140,000.00	0
Convenience Market with Gas Pumps	16.00	Pump	9.50	2,258.80	0

**1.2 Other Project Characteristics**

Urbanization	Urban	Wind Speed (m/s)	3.4	Precipitation Freq (Days)	12
Climate Zone	15			Operational Year	2025

Utility Company Imperial Irrigation District

CO2 Intensity (lb/MW/hr)	189.98	CH4 Intensity (lb/MW/hr)	0.033	N2O Intensity (lb/MW/hr)	0.004
--------------------------	--------	--------------------------	-------	--------------------------	-------

**1.3 User Entered Comments & Non-Default Data**

Project Characteristics -

Land Use - 284.5 acres site

Construction Phase - Construction Schedule

Off-road Equipment - CE

Trips and VMT - Project would use 24,250 trucks to deliver 24CY of stone material per truck during Grading and Building Construction. Per Mitigation Measure AQMM-1... all haul routes and worker trips to and from the site shall be 100% paved.

On-road Fugitive Dust - The Project assumes 90% paved. As a mitigation measure, the Project applicant shall prepare a Haul Route Plan which needs to be 100% paved and all worker trips shall utilize 100% paved roadways.

Grading - 1,000 CY of export grubbed material

Architectural Coating -







Green Valley Logistics (Imperial County) - Mitigated - Imperial County, Winter

**EMFAC Off-Model Adjustment Factors for Gasoline Light Duty Vehicle to Account for the SAFE Vehicle Rule Applied**

tblFleetMix	MCY	0.02	0.00
tblFleetMix	MDV	0.14	0.00
tblFleetMix	MH	3.3880e-003	0.00
tblFleetMix	MHD	8.3250e-003	0.00
tblFleetMix	OBUS	9.4100e-004	0.00
tblFleetMix	SBUS	7.5200e-004	0.00
tblFleetMix	UBUS	1.1800e-004	0.00
tblGrading	MaterialExported	0.00	1,000.00
tblLandUse	LotAcreage	1.15	207.00
tblLandUse	LotAcreage	22.96	64.00
tblLandUse	LotAcreage	3.15	4.00
tblLandUse	LotAcreage	0.05	9.50
tblOffRoadEquipment	OffRoadEquipmentUnitAmount	1.00	2.00
tblOnRoadDust	HaulingPercentPave	50.00	100.00
tblOnRoadDust	HaulingPercentPave	50.00	100.00
tblOnRoadDust	HaulingPercentPave	50.00	100.00
tblOnRoadDust	HaulingPercentPave	50.00	100.00
tblOnRoadDust	HaulingPercentPave	50.00	100.00
tblOnRoadDust	VendorPercentPave	50.00	100.00
tblOnRoadDust	VendorPercentPave	50.00	100.00
tblOnRoadDust	VendorPercentPave	50.00	100.00
tblOnRoadDust	VendorPercentPave	50.00	100.00
tblOnRoadDust	WorkerPercentPave	50.00	100.00
tblOnRoadDust	WorkerPercentPave	50.00	100.00
tblOnRoadDust	WorkerPercentPave	50.00	100.00
tblOnRoadDust	WorkerPercentPave	50.00	100.00
tblOnRoadDust	WorkerPercentPave	50.00	100.00
tblOnRoadDust	RoadPercentPave	50	90

**FEC ORIGINAL PKG**

Green Valley Logistics (Imperial County) - Mitigated - Imperial County, Winter

**EMFAC Off-Model Adjustment Factors for Gasoline Light Duty Vehicle to Account for the SAFE Vehicle Rule Applied**

tblSolidWaste	SolidWasteGenerationRate	940.00	188.00
tblTripsAndVMT	HaulingTripNumber	0.00	2,965.35
tblTripsAndVMT	HaulingTripNumber	0.00	21,284.65
tblVehicleTrips	DV_TP	21.00	0.00
tblVehicleTrips	DV_TP	5.00	0.00
tblVehicleTrips	DV_TP	5.00	0.00
tblVehicleTrips	PB_TP	65.00	0.00
tblVehicleTrips	PB_TP	3.00	0.00
tblVehicleTrips	PB_TP	3.00	0.00
tblVehicleTrips	PR_TP	14.00	0.00
tblVehicleTrips	PR_TP	92.00	100.00
tblVehicleTrips	PR_TP	92.00	0.00
tblVehicleTrips	ST_TR	322.50	0.00
tblVehicleTrips	ST_TR	6.42	0.43
tblVehicleTrips	ST_TR	1.74	0.00
tblVehicleTrips	SU_TR	322.50	0.00
tblVehicleTrips	SU_TR	5.09	0.43
tblVehicleTrips	SU_TR	1.74	0.00
tblVehicleTrips	WD_TR	322.50	0.00
tblVehicleTrips	WD_TR	3.93	0.43
tblVehicleTrips	WD_TR	1.74	0.00
tblWater	IndoorWaterUseRate	167,314.87	0.00
tblWater	IndoorWaterUseRate	11,562,500.00	0.00
tblWater	IndoorWaterUseRate	231,250,000.00	12,000,000.00
tblWater	OutdoorWaterUseRate	102,547.82	0.00
tblWater	OutdoorWaterUseRate	0.00	46,650,000.00

REC ORIGINAL PKG



Green Valley Logistics (Imperial County) - Mitigated - Imperial County, Winter

**EMFAC Off-Model Adjustment Factors for Gasoline Light Duty Vehicle to Account for the SAFE Vehicle Rule Applied**

**2.1 Overall Construction (Maximum Daily Emission)**

Unmitigated Construction

Year	lb/day															
	ROG	NOx	CO	SO2	Fugitive PM10	Exhaust PM10	PM10 Total	Fugitive PM2.5	Exhaust PM2.5	PM2.5 Total	Bio- CO2	NBio- CO2	Total CO2	CH4	N2O	CO2e
2024	69.1983	66.8738	48.7807	0.1553	30.2808	2.6495	32.9302	14.1434	2.4406	16.5840	0.0000	15,819.73	15,819.73	3.1541	1.3202	16,252.93
2025	68.9650	30.9630	34.8557	0.1367	6.1061	0.7271	6.8332	1.6669	0.6819	2.3488	0.0000	14,041.19	14,041.19	1.0618	1.2848	14,450.61
Maximum	69.1983	66.8738	48.7807	0.1553	30.2808	2.6495	32.9302	14.1434	2.4406	16.5840	0.0000	15,819.73	15,819.73	3.1541	1.3202	16,252.93

Mitigated Construction

Year	lb/day															
	ROG	NOx	CO	SO2	Fugitive PM10	Exhaust PM10	PM10 Total	Fugitive PM2.5	Exhaust PM2.5	PM2.5 Total	Bio- CO2	NBio- CO2	Total CO2	CH4	N2O	CO2e
2024	68.4141	56.3647	62.4049	0.1553	14.4050	0.4215	14.8265	6.5771	0.4178	6.9949	0.0000	15,819.73	15,819.73	3.1541	1.3202	16,252.93
2025	68.2829	33.9681	38.3726	0.1367	6.1061	0.3323	6.4384	1.6669	0.3245	1.9914	0.0000	14,041.19	14,041.19	1.0618	1.2848	14,450.61
Maximum	68.4141	56.3647	62.4049	0.1553	14.4050	0.4215	14.8265	6.5771	0.4178	6.9949	0.0000	15,819.73	15,819.73	3.1541	1.3202	16,252.93

EFC ORIGINAL PKG

Green Valley Logistics (Imperial County) - Mitigated - Imperial County, Winter

**EMFAC Off-Model Adjustment Factors for Gasoline Light Duty Vehicle to Account for the SAFE Vehicle Rule Applied**

	ROG	NOx	CO	SO2	Fugitive PM10	Exhaust PM10	PM10 Total	Fugitive PM2.5	Exhaust PM2.5	PM2.5 Total	Bio- CO2	NBio-CO2	Total CO2	CH4	N2O	CO2e
Percent Reduction	1.06	7.67	-20.49	0.00	43.63	77.67	46.52	47.86	76.23	52.54	0.00	0.00	0.00	0.00	0.00	0.00

Green Valley Logistics (Imperial County) - Mitigated - Imperial County, Winter

**EMFAC Off-Model Adjustment Factors for Gasoline Light Duty Vehicle to Account for the SAFE Vehicle Rule Applied**

**2.2 Overall Operational  
Unmitigated Operational**

Category	ROG	NOx	CO	SO2	Fugitive PM10	Exhaust PM10	PM10 Total	Fugitive PM2.5	Exhaust PM2.5	PM2.5 Total	Bio- CO2	NBio- CO2	Total CO2	CH4	N2O	CO2e
lb/day																
Area	26.6059	1.3100e-003	0.1442	1.0000e-005	5.1000e-004	5.1000e-004	5.1000e-004	5.1000e-004	5.1000e-004	5.1000e-004		0.3099	0.3099	8.1000e-004		0.3301
Energy	0.1073	0.9754	0.8194	5.8500e-003	0.0741	0.0741	0.0741	0.0741	0.0741	0.0741		1,170.4978	1,170.4978	0.0224	0.0215	1,177.4535
Mobile	0.0206	0.0168	0.2477	7.0000e-004	10.5142	4.3000e-004	10.5146	1.0632	4.0000e-004	1.0636		73.0773	73.0773	2.5500e-003	2.3200e-003	73.8317
<b>Total</b>	<b>26.7338</b>	<b>0.9935</b>	<b>1.2113</b>	<b>6.5600e-003</b>	<b>10.5142</b>	<b>0.0751</b>	<b>10.5892</b>	<b>1.0632</b>	<b>0.0750</b>	<b>1.1383</b>		<b>1,243.8850</b>	<b>1,243.8850</b>	<b>0.0258</b>	<b>0.0238</b>	<b>1,251.6152</b>

**Mitigated Operational**

EFC ORIGINAL PKG

Category	ROG	NOx	CO	SO2	Fugitive PM10	Exhaust PM10	PM10 Total	Fugitive PM2.5	Exhaust PM2.5	PM2.5 Total	Bio- CO2	NBio- CO2	Total CO2	CH4	N2O	CO2e
lb/day																
Area	26.6059	1.3100e-003	0.1442	1.0000e-005	5.1000e-004	5.1000e-004	5.1000e-004	5.1000e-004	5.1000e-004	5.1000e-004		0.3099	0.3099	8.1000e-004		0.3301
Energy	0.1073	0.9754	0.8194	5.8500e-003	0.0741	0.0741	0.0741	0.0741	0.0741	0.0741		1,170.4978	1,170.4978	0.0224	0.0215	1,177.4535
Mobile	0.0206	0.0168	0.2477	7.0000e-004	10.5142	4.3000e-004	10.5146	1.0632	4.0000e-004	1.0636		73.0773	73.0773	2.5500e-003	2.3200e-003	73.8317
<b>Total</b>	<b>26.7338</b>	<b>0.9935</b>	<b>1.2113</b>	<b>6.5600e-003</b>	<b>10.5142</b>	<b>0.0751</b>	<b>10.5892</b>	<b>1.0632</b>	<b>0.0750</b>	<b>1.1383</b>		<b>1,243.8850</b>	<b>1,243.8850</b>	<b>0.0258</b>	<b>0.0238</b>	<b>1,251.6152</b>

Green Valley Logistics (Imperial County) - Mitigated - Imperial County, Winter

**EMFAC Off-Model Adjustment Factors for Gasoline Light Duty Vehicle to Account for the SAFE Vehicle Rule Applied**

	ROG	NOx	CO	SO2	Fugitive PM10	Exhaust PM10	PM10 Total	Fugitive PM2.5	Exhaust PM2.5	PM2.5 Total	Bio-CO2	NBio-CO2	Total CO2	CH4	N2O	CO2e
Percent Reduction	0.00	0.00	0.00	0.00	0.00	0.00	0.00	0.00	0.00	0.00	0.00	0.00	0.00	0.00	0.00	0.00

**3.0 Construction Detail**

**Construction Phase**

Phase Number	Phase Name	Phase Type	Start Date	End Date	Num Days Week	Num Days	Phase Description
1	Site Preparation	Site Preparation	1/1/2024	3/1/2024	5	45	
2	Grading	Grading	2/1/2024	4/3/2024	5	45	
3	Building Construction	Building Construction	4/4/2024	6/30/2025	5	323	
4	Paving	Paving	4/4/2024	5/8/2024	5	25	
5	Architectural Coating	Architectural Coating	7/1/2024	5/9/2025	5	225	

**Acres of Grading (Site Preparation Phase): 67.5**

**Acres of Grading (Grading Phase): 135**

**Acres of Paving: 4**

**RTI**

**Residential Indoor: 0; Residential Outdoor: 0; Non-Residential Indoor: 1,578,388; Non-Residential Outdoor: 526,129; Striped Parking Area: 8,400 (Architectural Coating – sqft)**

**Off-Road Equipment**

Phase Name	Offroad Equipment Type	Amount	Usage Hours	Horse Power	Load Factor
Site Preparation	Rubber Tired Dozers	3	8.00	247	0.40
Site Preparation	Tractors/Loaders/Backhoes	4	8.00	97	0.37
Grading	Excavators	2	8.00	158	0.38
Grading	Graders	1	8.00	187	0.41
Grading	Rubber Tired Dozers	1	8.00	247	0.40
Grading	Scrapers	2	8.00	367	0.48



Green Valley Logistics (Imperial County) - Mitigated - Imperial County, Winter

**EMFAC Off-Model Adjustment Factors for Gasoline Light Duty Vehicle to Account for the SAFE Vehicle Rule Applied**

Grading	Tractors/Loaders/Backhoes	2	8.00	97	0.37
Building Construction	Aerial Lifts	2	8.00	63	0.31
Building Construction	Cranes	2	7.00	231	0.29
Building Construction	Rough Terrain Forklifts	2	8.00	100	0.40
Building Construction	Tractors/Loaders/Backhoes	3	7.00	97	0.37
Building Construction	Welders	1	8.00	46	0.45
Paving	Pavers	2	8.00	130	0.42
Paving	Paving Equipment	2	8.00	132	0.36
Paving	Rollers	2	8.00	80	0.38
Architectural Coating	Air Compressors	1	6.00	78	0.48

**Trips and VMT**

Phase Name	Offroad Equipment Count	Worker Trip Number	Vendor Trip Number	Hauling Trip Number	Worker Trip Length	Vendor Trip Length	Hauling Trip Length	Worker Vehicle Class	Vendor Vehicle Class	Hauling Vehicle Class
Site Preparation	7	18.00	0.00	125.00	7.30	8.90	20.00	LD_Mix	HDT_Mix	HHDT
Grading	8	20.00	0.00	2,965.35	7.30	8.90	20.00	LD_Mix	HDT_Mix	HHDT
Building Construction	10	501.00	195.00	21,284.65	7.30	8.90	20.00	LD_Mix	HDT_Mix	HHDT
Paving	6	15.00	0.00	0.00	7.30	8.90	20.00	LD_Mix	HDT_Mix	HHDT
Architectural Coating	1	100.00	0.00	0.00	7.30	8.90	20.00	LD_Mix	HDT_Mix	HHDT

**3.1 Mitigation Measures Construction**

Use Cleaner Engines for Construction Equipment

Use DPF for Construction Equipment

Water Exposed Area

Water Unpaved Roads

Reduce Vehicle Speed on Unpaved Roads



Green Valley Logistics (Imperial County) - Mitigated - Imperial County, Winter

**EMFAC Off-Model Adjustment Factors for Gasoline Light Duty Vehicle to Account for the SAFE Vehicle Rule Applied**

**3.2 Site Preparation - 2024**

**Unmitigated Construction On-Site**

Category	ROG	NOx	CO	SO2	Fugitive PM10	Exhaust PM10	PM10 Total	Fugitive PM2.5	Exhaust PM2.5	PM2.5 Total	Bio- CO2	NBio- CO2	Total CO2	CH4	N2O	CO2e
	lb/day															
Fugitive Dust					19.6614	0.0000	19.6614	10.1031	0.0000	10.1031			0.0000			0.0000
Off-Road	2.6609	27.1760	18.3356	0.0381		1.2294	1.2294		1.1310	1.1310		3.688.010	0	1.1928		3,717.829 4
<b>Total</b>	<b>2.6609</b>	<b>27.1760</b>	<b>18.3356</b>	<b>0.0381</b>	<b>19.6614</b>	<b>1.2294</b>	<b>20.8908</b>	<b>10.1031</b>	<b>1.1310</b>	<b>11.2341</b>		<b>3,688.010</b>	<b>0</b>	<b>1.1928</b>		<b>3,717.829</b> <b>4</b>

**Unmitigated Construction Off-Site**

Category	ROG	NOx	CO	SO2	Fugitive PM10	Exhaust PM10	PM10 Total	Fugitive PM2.5	Exhaust PM2.5	PM2.5 Total	Bio- CO2	NBio- CO2	Total CO2	CH4	N2O	CO2e
	lb/day															
Hauling	6.0800e-003	0.2935	0.0821	1.4800e-003	0.0487	3.3800e-003	0.0521	0.0134	3.2400e-003	0.0166		156.5280	156.5280	4.2000e-004	0.0246	163.8711
Vendor	0.0000	0.0000	0.0000	0.0000	0.0000	0.0000	0.0000	0.0000	0.0000	0.0000		0.0000	0.0000	0.0000	0.0000	0.0000
Worker	0.0520	0.0303	0.3278	7.8000e-004	0.1000	5.0000e-004	0.1005	0.0265	4.6000e-004	0.0270		79.9650	79.9650	3.4100e-003	2.9300e-003	80.9220
<b>Total</b>	<b>0.0581</b>	<b>0.3238</b>	<b>0.4099</b>	<b>2.2600e-003</b>	<b>0.1487</b>	<b>3.8800e-003</b>	<b>0.1526</b>	<b>0.0399</b>	<b>3.7000e-003</b>	<b>0.0436</b>		<b>236.4930</b>	<b>236.4930</b>	<b>3.8300e-003</b>	<b>0.0275</b>	<b>244.7931</b>

EEC ORIGINAL PKG

Green Valley Logistics (Imperial County) - Mitigated - Imperial County, Winter

**EMFAC Off-Model Adjustment Factors for Gasoline Light Duty Vehicle to Account for the SAFE Vehicle Rule Applied**

**3.2 Site Preparation - 2024**

**Mitigated Construction On-Site**

Category	ROG	NOx	CO	SO2	Fugitive PM10	Exhaust PM10	PM10 Total	Fugitive PM2.5	Exhaust PM2.5	PM2.5 Total	Bio- CO2	NBio- CO2	Total CO2	CH4	N2O	CO2e
lb/day																
Fugitive Dust					8.8477	0.0000	8.8477	4.5464	0.0000	4.5464			0.0000			0.0000
Off-Road	0.9312	19.0656	22.9600	0.0381		0.1419	0.1419		0.1419	0.1419	0.0000	3.688,010	3.688,010	1.1928		3,717.829
<b>Total</b>	<b>0.9312</b>	<b>19.0656</b>	<b>22.9600</b>	<b>0.0381</b>	<b>8.8477</b>	<b>0.1419</b>	<b>8.9896</b>	<b>4.5464</b>	<b>0.1419</b>	<b>4.6883</b>	<b>0.0000</b>	<b>3.688,010</b>	<b>3.688,010</b>	<b>1.1928</b>		<b>3,717.829</b>

**Mitigated Construction Off-Site**

Category	ROG	NOx	CO	SO2	Fugitive PM10	Exhaust PM10	PM10 Total	Fugitive PM2.5	Exhaust PM2.5	PM2.5 Total	Bio- CO2	NBio- CO2	Total CO2	CH4	N2O	CO2e
lb/day																
Hauling	6.0800e-003	0.2935	0.0821	1.4800e-003	0.0487	3.3800e-003	0.0521	0.0134	3.2400e-003	0.0166		156.5280	156.5280	4.2000e-004	0.0246	163.8711
Vendor	0.0000	0.0000	0.0000	0.0000	0.0000	0.0000	0.0000	0.0000	0.0000	0.0000		0.0000	0.0000	0.0000	0.0000	0.0000
Worker	0.0520	0.0303	0.3278	7.8000e-004	0.1000	5.0000e-004	0.1005	0.0265	4.6000e-004	0.0270		79.9650	79.9650	3.4100e-003	2.9300e-003	80.9220
<b>Total</b>	<b>0.0581</b>	<b>0.3238</b>	<b>0.4099</b>	<b>2.2600e-003</b>	<b>0.1487</b>	<b>3.8800e-003</b>	<b>0.1526</b>	<b>0.0399</b>	<b>3.7000e-003</b>	<b>0.0436</b>		<b>236.4930</b>	<b>236.4930</b>	<b>3.8300e-003</b>	<b>0.0275</b>	<b>244.7931</b>

EEC ORIGINAL PKG

Green Valley Logistics (Imperial County) - Mitigated - Imperial County, Winter

**EMFAC Off-Model Adjustment Factors for Gasoline Light Duty Vehicle to Account for the SAFE Vehicle Rule Applied**

**3.3 Grading - 2024**

**Unmitigated Construction On-Site**

Category	ROG	NOx	CO	SO2	Fugitive PM10	Exhaust PM10	PM10 Total	Fugitive PM2.5	Exhaust PM2.5	PM2.5 Total	Bio- CO2	NBio- CO2	Total CO2	CH4	N2O	CO2e
	lb/day															
Fugitive Dust					9.2036	0.0000	9.2036	3.6538	0.0000	3.6538			0.0000			0.0000
Off-Road	3.2181	32.3770	27.7228	0.0621		1.3354	1.3354	1.2286	1.2286	2.5640		6,009.748 <sub>7</sub>	6,009.748 <sub>7</sub>	1.9437		6,058.340 <sub>5</sub>
<b>Total</b>	<b>3.2181</b>	<b>32.3770</b>	<b>27.7228</b>	<b>0.0621</b>	<b>9.2036</b>	<b>1.3354</b>	<b>10.5390</b>	<b>3.6538</b>	<b>1.2286</b>	<b>4.8823</b>		<b>6,009.748<sub>7</sub></b>	<b>6,009.748<sub>7</sub></b>	<b>1.9437</b>		<b>6,058.340<sub>5</sub></b>

**Unmitigated Construction Off-Site**

Category	ROG	NOx	CO	SO2	Fugitive PM10	Exhaust PM10	PM10 Total	Fugitive PM2.5	Exhaust PM2.5	PM2.5 Total	Bio- CO2	NBio- CO2	Total CO2	CH4	N2O	CO2e
	lb/day															
Hauling	0.1444	6.9634	1.9482	0.0351	1.1559	0.0803	1.2362	0.3171	0.0768	0.3939		3,714.096 <sub>2</sub>	3,714.096 <sub>2</sub>	9.9900e-003	0.5839	3,888.333 <sub>2</sub>
Vendor	0.0000	0.0000	0.0000	0.0000	0.0000	0.0000	0.0000	0.0000	0.0000	0.0000		0.0000	0.0000	0.0000	0.0000	0.0000
Worker	0.0578	0.0337	0.3642	8.6000e-004	0.1111	5.5000e-004	0.1117	0.0295	5.1000e-004	0.0300		88.8500	88.8500	3.7900e-003	3.2500e-003	89.9134
<b>Total</b>	<b>0.2021</b>	<b>6.9971</b>	<b>2.3124</b>	<b>0.0359</b>	<b>1.2670</b>	<b>0.0808</b>	<b>1.3478</b>	<b>0.3466</b>	<b>0.0773</b>	<b>0.4239</b>		<b>3,802.946<sub>2</sub></b>	<b>3,802.946<sub>2</sub></b>	<b>0.0138</b>	<b>0.5871</b>	<b>3,978.246<sub>6</sub></b>

TEC ORIGINAL PKG



Green Valley Logistics (Imperial County) - Mitigated - Imperial County, Winter

**EMFAC Off-Model Adjustment Factors for Gasoline Light Duty Vehicle to Account for the SAFE Vehicle Rule Applied**

**3.3 Grading - 2024**

**Mitigated Construction On-Site**

Category	lb/day											CO2e				
	ROG	NOx	CO	SO2	Fugitive PM10	Exhaust PM10	PM10 Total	Fugitive PM2.5	Exhaust PM2.5	PM2.5 Total	Bio- CO2		NBio- CO2	Total CO2	CH4	N2O
Fugitive Dust					4.1416	0.0000	4.1416	1.6442	0.0000	1.6442			0.0000			0.0000
Off-Road	1.5231	29.9782	36.7226	0.0621		0.1949	0.1949	0.1949	0.1949	0.1949	0.0000	6,009.748	6,009.748	1.9437		6,058.340
<b>Total</b>	<b>1.5231</b>	<b>29.9782</b>	<b>36.7226</b>	<b>0.0621</b>	<b>4.1416</b>	<b>0.1949</b>	<b>4.3365</b>	<b>1.6442</b>	<b>0.1949</b>	<b>1.8391</b>	<b>0.0000</b>	<b>6,009.748</b>	<b>6,009.748</b>	<b>1.9437</b>		<b>6,058.340</b>

**Mitigated Construction Off-Site**

Category	lb/day											CO2e				
	ROG	NOx	CO	SO2	Fugitive PM10	Exhaust PM10	PM10 Total	Fugitive PM2.5	Exhaust PM2.5	PM2.5 Total	Bio- CO2		NBio- CO2	Total CO2	CH4	N2O
Hauling	0.1444	6.9634	1.9482	0.0351	1.1559	0.0803	1.2362	0.3171	0.0768	0.3939			3,714.096	9.9900e-003	0.5839	3,888.333
Vendor	0.0000	0.0000	0.0000	0.0000	0.0000	0.0000	0.0000	0.0000	0.0000	0.0000			0.0000	0.0000	0.0000	0.0000
Worker	0.0578	0.0337	0.3642	8.6000e-004	0.1111	5.5000e-004	0.1117	0.0295	5.1000e-004	0.0300			88.8500	3.7900e-003	3.2500e-003	89.9134
<b>Total</b>	<b>0.2021</b>	<b>6.9971</b>	<b>2.3124</b>	<b>0.0359</b>	<b>1.2670</b>	<b>0.0808</b>	<b>1.3478</b>	<b>0.3466</b>	<b>0.0773</b>	<b>0.4239</b>			<b>3,802.946</b>	<b>0.0138</b>	<b>0.5871</b>	<b>3,978.246</b>

EEC ORIGINAL PKG

Green Valley Logistics (Imperial County) - Mitigated - Imperial County, Winter

**EMFAC Off-Model Adjustment Factors for Gasoline Light Duty Vehicle to Account for the SAFE Vehicle Rule Applied**

**3.4 Building Construction - 2024**

**Unmitigated Construction On-Site**

Category	lb/day															
	ROG	NOx	CO	SO2	Fugitive PM10	Exhaust PM10	PM10 Total	Fugitive PM2.5	Exhaust PM2.5	PM2.5 Total	Bio- CO2	NBio- CO2	Total CO2	CH4	N2O	CO2e
Off-Road	1.4882	15.0679	17.4016	0.0311		0.5776	0.5776		0.5352	0.5352		2,970.240 4	2,970.240 4	0.9147		2,993.108 1
<b>Total</b>	<b>1.4882</b>	<b>15.0679</b>	<b>17.4016</b>	<b>0.0311</b>		<b>0.5776</b>	<b>0.5776</b>		<b>0.5352</b>	<b>0.5352</b>		<b>2,970.240 4</b>	<b>2,970.240 4</b>	<b>0.9147</b>		<b>2,993.108 1</b>

**Unmitigated Construction Off-Site**

Category	lb/day															
	ROG	NOx	CO	SO2	Fugitive PM10	Exhaust PM10	PM10 Total	Fugitive PM2.5	Exhaust PM2.5	PM2.5 Total	Bio- CO2	NBio- CO2	Total CO2	CH4	N2O	CO2e
Hauling	0.1443	6.9620	1.9478	0.0351	1.1559	0.0803	1.2361	0.3171	0.0768	0.3939		3,713.347 9	3,713.347 9	9.9900e- 003	0.5837	3,887.549 9
Vendor	0.3799	8.1546	3.7503	0.0441	1.6112	0.0721	1.6833	0.4639	0.0690	0.5329		4,636.272 6	4,636.272 6	0.0199	0.6388	4,827.120 3
Worker	1.4471	0.8435	9.1226	0.0216	2.7834	0.0138	2.7972	0.7385	0.0127	0.7512		2,225.693 0	2,225.693 0	0.0949	0.0814	2,252.329 3
<b>Total</b>	<b>1.9713</b>	<b>15.9601</b>	<b>14.8208</b>	<b>0.1007</b>	<b>5.5505</b>	<b>0.1662</b>	<b>5.7166</b>	<b>1.5195</b>	<b>0.1565</b>	<b>1.6780</b>		<b>10,575.31 35</b>	<b>10,575.31 35</b>	<b>0.1249</b>	<b>1.3039</b>	<b>10,966.99 95</b>

EEC ORIGINAL PKG

Green Valley Logistics (Imperial County) - Mitigated - Imperial County, Winter

**EMFAC Off-Model Adjustment Factors for Gasoline Light Duty Vehicle to Account for the SAFE Vehicle Rule Applied**

**3.4 Building Construction - 2024**

**Mitigated Construction On-Site**

Category	ROG	NOx	CO	SO2	Fugitive PM10	Exhaust PM10	PM10 Total	Fugitive PM2.5	Exhaust PM2.5	PM2.5 Total	Bio- CO2	NBio- CO2	Total CO2	CH4	N2O	CO2e
Off-Road	0.8054	16.7936	20.7901	0.0311	0.1510	0.1510	0.1510	0.1510	0.1510	0.1510	0.0000	2,970.2404	2,970.2404	0.9147		2,993.1081
<b>Total</b>	<b>0.8054</b>	<b>16.7936</b>	<b>20.7901</b>	<b>0.0311</b>	<b>0.1510</b>	<b>0.1510</b>	<b>0.1510</b>	<b>0.1510</b>	<b>0.1510</b>	<b>0.1510</b>	<b>0.0000</b>	<b>2,970.2404</b>	<b>2,970.2404</b>	<b>0.9147</b>		<b>2,993.1081</b>

**Mitigated Construction Off-Site**

Category	ROG	NOx	CO	SO2	Fugitive PM10	Exhaust PM10	PM10 Total	Fugitive PM2.5	Exhaust PM2.5	PM2.5 Total	Bio- CO2	NBio- CO2	Total CO2	CH4	N2O	CO2e
Hauling	0.1443	6.9620	1.9478	0.0351	1.1559	0.0803	1.2361	0.3171	0.0768	0.3939		3,713.3479	3,713.3479	9.9900e-003	0.5837	3,887.5499
Vendor	0.3799	8.1546	3.7503	0.0441	1.6112	0.0721	1.6833	0.4639	0.0690	0.5329		4,636.2726	4,636.2726	0.0199	0.6388	4,827.1203
Worker	1.4471	0.8435	9.1226	0.0216	2.7834	0.0138	2.7972	0.7385	0.0127	0.7512		2,225.6930	2,225.6930	0.0949	0.0814	2,252.3293
<b>Total</b>	<b>1.9713</b>	<b>15.9601</b>	<b>14.8208</b>	<b>0.1007</b>	<b>5.5505</b>	<b>0.1662</b>	<b>5.7166</b>	<b>1.5195</b>	<b>0.1585</b>	<b>1.6780</b>		<b>10,575.3135</b>	<b>10,575.3135</b>	<b>0.1249</b>	<b>1.3039</b>	<b>10,966.9995</b>

REC ORIGINAL PKG

Green Valley Logistics (Imperial County) - Mitigated - Imperial County, Winter

**EMFAC Off-Model Adjustment Factors for Gasoline Light Duty Vehicle to Account for the SAFE Vehicle Rule Applied**

**3.4 Building Construction - 2025**

**Unmitigated Construction On-Site**

Category	lb/day																
	ROG	NOx	CO	SO2	Fugitive PM10	Exhaust PM10	PM10 Total	Fugitive PM2.5	Exhaust PM2.5	PM2.5 Total	Bio- CO2	NBio- CO2	Total CO2	CH4	N2O	CO2e	
Off-Road	1.3760	14.0000	17.2964	0.0311		0.5085	0.5085		0.4711	0.4711		2,970.995	0	2,970.995	0.9135		2,993.832
<b>Total</b>	<b>1.3760</b>	<b>14.0000</b>	<b>17.2964</b>	<b>0.0311</b>		<b>0.5085</b>	<b>0.5085</b>		<b>0.4711</b>	<b>0.4711</b>		<b>2,970.995</b>	<b>0</b>	<b>2,970.995</b>	<b>0.9135</b>		<b>2,993.832</b>

**Unmitigated Construction Off-Site**

Category	lb/day																
	ROG	NOx	CO	SO2	Fugitive PM10	Exhaust PM10	PM10 Total	Fugitive PM2.5	Exhaust PM2.5	PM2.5 Total	Bio- CO2	NBio- CO2	Total CO2	CH4	N2O	CO2e	
Hauling	0.1441	6.8719	1.9516	0.0343	1.1559	0.0797	1.2356	0.3171	0.0763	0.3934		3,627.892	2	3,627.892	0.0104		3,798.099
Vendor	0.3692	8.0408	3.6473	0.0433	1.6112	0.0717	1.6829	0.4639	0.0686	0.5325		4,555.969	6	4,555.969	0.0195		4,742.323
Worker	1.3468	0.7543	8.4621	0.0208	2.7834	0.0130	2.7965	0.7385	0.0120	0.7505		2,171.465	4	2,171.465	0.0860		2,196.171
<b>Total</b>	<b>1.8602</b>	<b>15.6670</b>	<b>14.0611</b>	<b>0.0984</b>	<b>5.5505</b>	<b>0.1645</b>	<b>5.7150</b>	<b>1.5195</b>	<b>0.1569</b>	<b>1.8764</b>		<b>10,355.32</b>	<b>71</b>	<b>10,355.32</b>	<b>0.1158</b>		<b>10,736.59</b>

REC ORIGINAL FKG



Green Valley Logistics (Imperial County) - Mitigated - Imperial County, Winter

**EMFAC Off-Model Adjustment Factors for Gasoline Light Duty Vehicle to Account for the SAFE Vehicle Rule Applied**

**3.4 Building Construction - 2025**

**Mitigated Construction On-Site**

Category	ROG	NOx	CO	SO2	Fugitive PM10	Exhaust PM10	PM10 Total	Fugitive PM2.5	Exhaust PM2.5	PM2.5 Total	Bio- CO2	NBio- CO2	Total CO2	CH4	N2O	CO2e
	lb/day															
Off-Road	0.8054	16.7936	20.7901	0.0311	0.1510	0.1510	0.1510	0.1510	0.1510	0.1510	0.0000	2,970.995	2,970.995	0.9135		2,993.832
Total	0.8054	16.7936	20.7901	0.0311	0.1510	0.1510	0.1510	0.1510	0.1510	0.1510	0.0000	2,970.995	2,970.995	0.9135		2,993.832

**Mitigated Construction Off-Site**

Category	ROG	NOx	CO	SO2	Fugitive PM10	Exhaust PM10	PM10 Total	Fugitive PM2.5	Exhaust PM2.5	PM2.5 Total	Bio- CO2	NBio- CO2	Total CO2	CH4	N2O	CO2e
	lb/day															
Hauling	0.1441	6.8719	1.9516	0.0343	1.1559	0.0797	1.2356	0.3171	0.0763	0.3934		3,627.892	3,627.892	0.0104	0.5703	3,798.099
Vendor	0.3692	8.0408	3.6473	0.0433	1.6112	0.0717	1.6829	0.4639	0.0686	0.5325		4,555.969	4,555.969	0.0195	0.6237	4,742.323
Worker	1.3468	0.7543	8.4621	0.0208	2.7834	0.0130	2.7965	0.7385	0.0120	0.7505		2,171.465	2,171.465	0.0860	0.0757	2,196.171
Total	1.8602	15.6670	14.0611	0.0984	5.5505	0.1645	5.7150	1.5195	0.1569	1.6764		10,355.32	10,355.32	0.1158	1.2697	10,736.59

EEC ORIGINAL PKG

Green Valley Logistics (Imperial County) - Mitigated - Imperial County, Winter

**EMFAC Off-Model Adjustment Factors for Gasoline Light Duty Vehicle to Account for the SAFE Vehicle Rule Applied**

**3.5 Paving - 2024**

**Unmitigated Construction On-Site**

Category	lb/day															
	ROG	NOx	CO	SO2	Fugitive PM10	Exhaust PM10	PM10 Total	Fugitive PM2.5	Exhaust PM2.5	PM2.5 Total	Bio- CO2	NBio- CO2	Total CO2	CH4	N2O	CO2e
Off-Road	0.9882	9.5246	14.6258	0.0228		0.4685	0.4685		0.4310	0.4310		2,207.547 2	2,207.547 2	0.7140		2,225.396 3
Paving	0.4192					0.0000	0.0000		0.0000	0.0000		0.0000	0.0000			0.0000
<b>Total</b>	<b>1.4074</b>	<b>9.5246</b>	<b>14.6258</b>	<b>0.0228</b>		<b>0.4685</b>	<b>0.4685</b>		<b>0.4310</b>	<b>0.4310</b>		<b>2,207.547 2</b>	<b>2,207.547 2</b>	<b>0.7140</b>		<b>2,225.396 3</b>

**Unmitigated Construction Off-Site**

Category	lb/day															
	ROG	NOx	CO	SO2	Fugitive PM10	Exhaust PM10	PM10 Total	Fugitive PM2.5	Exhaust PM2.5	PM2.5 Total	Bio- CO2	NBio- CO2	Total CO2	CH4	N2O	CO2e
Hauling	0.0000	0.0000	0.0000	0.0000	0.0000	0.0000	0.0000	0.0000	0.0000	0.0000		0.0000	0.0000	0.0000		0.0000
Vendor	0.0000	0.0000	0.0000	0.0000	0.0000	0.0000	0.0000	0.0000	0.0000	0.0000		0.0000	0.0000	0.0000		0.0000
Worker	0.0433	0.0253	0.2731	6.5000e-004	0.0833	4.1000e-004	0.0838	0.0221	3.8000e-004	0.0225		66.6375	66.6375	2.8400e-003	2.4400e-003	67.4350
<b>Total</b>	<b>0.0433</b>	<b>0.0253</b>	<b>0.2731</b>	<b>6.5000e-004</b>	<b>0.0833</b>	<b>4.1000e-004</b>	<b>0.0838</b>	<b>0.0221</b>	<b>3.8000e-004</b>	<b>0.0225</b>		<b>66.6375</b>	<b>66.6375</b>	<b>2.8400e-003</b>	<b>2.4400e-003</b>	<b>67.4350</b>

EEC ORIGINAL PKG

Green Valley Logistics (Imperial County) - Mitigated - Imperial County, Winter

**EMFAC Off-Model Adjustment Factors for Gasoline Light Duty Vehicle to Account for the SAFE Vehicle Rule Applied**

**3.5 Paving - 2024**

**Mitigated Construction On-Site**

Category	ROG	NOx	CO	SO2	Fugitive PM10	Exhaust PM10	PM10 Total	Fugitive PM2.5	Exhaust PM2.5	PM2.5 Total	Bio- CO2	NBio- CO2	Total CO2	CH4	N2O	CO2e
	lb/day															
Off-Road	0.5609	11.2952	17.2957	0.0228	0.0914	0.0914	0.0914	0.0914	0.0914	0.0914	0.0000	2,207.547 <sub>2</sub>	2,207.547 <sub>2</sub>	0.7140		2,225.396 <sub>3</sub>
Paving	0.4192				0.0000	0.0000	0.0000	0.0000	0.0000	0.0000			0.0000			0.0000
<b>Total</b>	<b>0.9801</b>	<b>11.2952</b>	<b>17.2957</b>	<b>0.0228</b>	<b>0.0914</b>	<b>0.0914</b>	<b>0.0914</b>	<b>0.0914</b>	<b>0.0914</b>	<b>0.0914</b>	<b>0.0000</b>	<b>2,207.547<sub>2</sub></b>	<b>2,207.547<sub>2</sub></b>	<b>0.7140</b>		<b>2,225.396<sub>3</sub></b>

**Mitigated Construction Off-Site**

Category	ROG	NOx	CO	SO2	Fugitive PM10	Exhaust PM10	PM10 Total	Fugitive PM2.5	Exhaust PM2.5	PM2.5 Total	Bio- CO2	NBio- CO2	Total CO2	CH4	N2O	CO2e
	lb/day															
Hauling	0.0000	0.0000	0.0000	0.0000	0.0000	0.0000	0.0000	0.0000	0.0000	0.0000			0.0000	0.0000	0.0000	0.0000
Vendor	0.0000	0.0000	0.0000	0.0000	0.0000	0.0000	0.0000	0.0000	0.0000	0.0000			0.0000	0.0000	0.0000	0.0000
Worker	0.0433	0.0253	0.2731	6.5000e-004	0.0833	4.1000e-004	0.0838	0.0221	3.8000e-004	0.0225			66.6375	2.8400e-003	2.4400e-003	67.4350
<b>Total</b>	<b>0.0433</b>	<b>0.0253</b>	<b>0.2731</b>	<b>6.5000e-004</b>	<b>0.0833</b>	<b>4.1000e-004</b>	<b>0.0838</b>	<b>0.0221</b>	<b>3.8000e-004</b>	<b>0.0225</b>			<b>66.6375</b>	<b>2.8400e-003</b>	<b>2.4400e-003</b>	<b>67.4350</b>

EEC ORIGINAL PKG

Green Valley Logistics (Imperial County) - Mitigated - Imperial County, Winter

**EMFAC Off-Model Adjustment Factors for Gasoline Light Duty Vehicle to Account for the SAFE Vehicle Rule Applied**

**3.6 Architectural Coating - 2024  
Unmitigated Construction On-Site**

Category	ROG	NOx	CO	SO2	Fugitive PM10	Exhaust PM10	PM10 Total	Fugitive PM2.5	Exhaust PM2.5	PM2.5 Total	Bio- CO2	NBio- CO2	Total CO2	CH4	N2O	CO2e
lb/day																
Archit. Coating	65.2891					0.0000	0.0000		0.0000	0.0000			0.0000			0.0000
Off-Road	0.1808	1.2188	1.8101	2.9700e-003		0.0609	0.0609		0.0609	0.0609			281.4481	0.0159		281.8443
<b>Total</b>	<b>65.4699</b>	<b>1.2188</b>	<b>1.8101</b>	<b>2.9700e-003</b>		<b>0.0609</b>	<b>0.0609</b>		<b>0.0609</b>	<b>0.0609</b>			<b>281.4481</b>	<b>0.0159</b>		<b>281.8443</b>

**Unmitigated Construction Off-Site**

Category	ROG	NOx	CO	SO2	Fugitive PM10	Exhaust PM10	PM10 Total	Fugitive PM2.5	Exhaust PM2.5	PM2.5 Total	Bio- CO2	NBio- CO2	Total CO2	CH4	N2O	CO2e
lb/day																
Hauling	0.0000	0.0000	0.0000	0.0000	0.0000	0.0000	0.0000	0.0000	0.0000	0.0000			0.0000	0.0000	0.0000	0.0000
Vendor	0.0000	0.0000	0.0000	0.0000	0.0000	0.0000	0.0000	0.0000	0.0000	0.0000			0.0000	0.0000	0.0000	0.0000
Worker	0.2888	0.1684	1.8209	4.3100e-003	0.5556	2.7500e-003	0.5583	0.1474	2.5400e-003	0.1499			444.2501	0.0190	0.0163	449.5667
<b>Total</b>	<b>0.2888</b>	<b>0.1684</b>	<b>1.8209</b>	<b>4.3100e-003</b>	<b>0.5556</b>	<b>2.7500e-003</b>	<b>0.5583</b>	<b>0.1474</b>	<b>2.5400e-003</b>	<b>0.1499</b>			<b>444.2501</b>	<b>0.0190</b>	<b>0.0163</b>	<b>449.5667</b>

EEC ORIGINAL PKG



Green Valley Logistics (Imperial County) - Mitigated - Imperial County, Winter

**EMFAC Off-Model Adjustment Factors for Gasoline Light Duty Vehicle to Account for the SAFE Vehicle Rule Applied**

**3.6 Architectural Coating - 2024**

**Mitigated Construction On-Site**

Category	ROG	NOx	CO	SO2	Fugitive PM10	Exhaust PM10	PM10 Total	Fugitive PM2.5	Exhaust PM2.5	PM2.5 Total	Bio- CO2	NIbio- CO2	Total CO2	CH4	N2O	CO2e
lb/day																
Archit. Coating	65.2891				0.0000	0.0000	0.0000	0.0000	0.0000	0.0000			0.0000			0.0000
Off-Road	0.0594	1.3570	1.8324	2.9700e-003		0.0143	0.0143		0.0143	0.0143	0.0000	281.4481	281.4481	0.0159		281.8443
<b>Total</b>	<b>65.3486</b>	<b>1.3570</b>	<b>1.8324</b>	<b>2.9700e-003</b>		<b>0.0143</b>	<b>0.0143</b>		<b>0.0143</b>	<b>0.0143</b>	<b>0.0000</b>	<b>281.4481</b>	<b>281.4481</b>	<b>0.0159</b>		<b>281.8443</b>

**Mitigated Construction Off-Site**

Category	ROG	NOx	CO	SO2	Fugitive PM10	Exhaust PM10	PM10 Total	Fugitive PM2.5	Exhaust PM2.5	PM2.5 Total	Bio- CO2	NIbio- CO2	Total CO2	CH4	N2O	CO2e
lb/day																
Hauling	0.0000	0.0000	0.0000	0.0000	0.0000	0.0000	0.0000	0.0000	0.0000	0.0000			0.0000	0.0000		0.0000
Vendor	0.0000	0.0000	0.0000	0.0000	0.0000	0.0000	0.0000	0.0000	0.0000	0.0000			0.0000	0.0000		0.0000
Worker	0.2888	0.1684	1.8209	4.3100e-003	0.5556	2.7500e-003	0.5563	0.1474	2.5400e-003	0.1499		444.2501	444.2501	0.0190	0.0163	449.5667
<b>Total</b>	<b>0.2888</b>	<b>0.1684</b>	<b>1.8209</b>	<b>4.3100e-003</b>	<b>0.5556</b>	<b>2.7500e-003</b>	<b>0.5563</b>	<b>0.1474</b>	<b>2.5400e-003</b>	<b>0.1499</b>		<b>444.2501</b>	<b>444.2501</b>	<b>0.0190</b>	<b>0.0163</b>	<b>449.5667</b>

EEC ORIGINAL PKG

Green Valley Logistics (Imperial County) - Mitigated - Imperial County, Winter

**EMFAC Off-Model Adjustment Factors for Gasoline Light Duty Vehicle to Account for the SAFE Vehicle Rule Applied**

**3.6 Architectural Coating - 2025  
Unmitigated Construction On-Site**

Category	ROG	NOx	CO	SO2	Fugitive PM10	Exhaust PM10	PM10 Total	Fugitive PM2.5	Exhaust PM2.5	PM2.5 Total	Bio- CO2	NBio- CO2	Total CO2	CH4	N2O	CO2e
lb/day																
Archit. Coating	65.2891				0.0000	0.0000	0.0000	0.0000	0.0000	0.0000			0.0000			0.0000
Off-Road	0.1709	1.1455	1.8091	2.9700e-003	0.0515	0.0515	0.0515	0.0515	0.0515	0.0515		281.4481	281.4481	0.0154		281.8319
<b>Total</b>	<b>65.4600</b>	<b>1.1455</b>	<b>1.8091</b>	<b>2.9700e-003</b>	<b>0.0515</b>	<b>0.0515</b>	<b>0.0515</b>	<b>0.0515</b>	<b>0.0515</b>	<b>0.0515</b>		<b>281.4481</b>	<b>281.4481</b>	<b>0.0154</b>		<b>281.8319</b>

**Unmitigated Construction Off-Site**

Category	ROG	NOx	CO	SO2	Fugitive PM10	Exhaust PM10	PM10 Total	Fugitive PM2.5	Exhaust PM2.5	PM2.5 Total	Bio- CO2	NBio- CO2	Total CO2	CH4	N2O	CO2e
lb/day																
Hauling	0.0000	0.0000	0.0000	0.0000	0.0000	0.0000	0.0000	0.0000	0.0000	0.0000			0.0000	0.0000		0.0000
Vendor	0.0000	0.0000	0.0000	0.0000	0.0000	0.0000	0.0000	0.0000	0.0000	0.0000			0.0000	0.0000		0.0000
Worker	0.2688	0.1506	1.6890	4.1600e-003	0.5556	2.6000e-003	0.5582	0.1474	2.3900e-003	0.1498		433.4262	433.4262	0.0172	0.0151	438.3576
<b>Total</b>	<b>0.2688</b>	<b>0.1506</b>	<b>1.6890</b>	<b>4.1600e-003</b>	<b>0.5556</b>	<b>2.6000e-003</b>	<b>0.5582</b>	<b>0.1474</b>	<b>2.3900e-003</b>	<b>0.1498</b>		<b>433.4262</b>	<b>433.4262</b>	<b>0.0172</b>	<b>0.0151</b>	<b>438.3576</b>

EEC ORIGINAL PKG

Green Valley Logistics (Imperial County) - Mitigated - Imperial County, Winter

**EMFAC Off-Model Adjustment Factors for Gasoline Light Duty Vehicle to Account for the SAFE Vehicle Rule Applied**

**3.6 Architectural Coating - 2025**

**Mitigated Construction On-Site**

Category	ROG	NOx	CO	SO2	Fugitive PM10	Exhaust PM10	PM10 Total	Fugitive PM2.5	Exhaust PM2.5	PM2.5 Total	Bio- CO2	NBio- CO2	Total CO2	CH4	N2O	CO2e
lb/day																
Archit. Coating	65.2891					0.0000	0.0000		0.0000	0.0000			0.0000			0.0000
Off-Road	0.0594	1.3570	1.8324	2.9700e-003		0.0143	0.0143		0.0143	0.0143	0.0000	281.4481	281.4481	0.0154		281.8319
<b>Total</b>	<b>65.3486</b>	<b>1.3570</b>	<b>1.8324</b>	<b>2.9700e-003</b>		<b>0.0143</b>	<b>0.0143</b>		<b>0.0143</b>	<b>0.0143</b>	<b>0.0000</b>	<b>281.4481</b>	<b>281.4481</b>	<b>0.0154</b>		<b>281.8319</b>

**Mitigated Construction Off-Site**

Category	ROG	NOx	CO	SO2	Fugitive PM10	Exhaust PM10	PM10 Total	Fugitive PM2.5	Exhaust PM2.5	PM2.5 Total	Bio- CO2	NBio- CO2	Total CO2	CH4	N2O	CO2e
lb/day																
Hauling	0.0000	0.0000	0.0000	0.0000	0.0000	0.0000	0.0000	0.0000	0.0000	0.0000			0.0000	0.0000		0.0000
Vendor	0.0000	0.0000	0.0000	0.0000	0.0000	0.0000	0.0000	0.0000	0.0000	0.0000			0.0000	0.0000		0.0000
Worker	0.2688	0.1506	1.6890	4.1600e-003	0.5556	2.6000e-003	0.5582	0.1474	2.3900e-003	0.1498			433.4262	0.0172	0.0151	438.3576
<b>Total</b>	<b>0.2688</b>	<b>0.1506</b>	<b>1.6890</b>	<b>4.1600e-003</b>	<b>0.5556</b>	<b>2.6000e-003</b>	<b>0.5582</b>	<b>0.1474</b>	<b>2.3900e-003</b>	<b>0.1498</b>			<b>433.4262</b>	<b>0.0172</b>	<b>0.0151</b>	<b>438.3576</b>

REC ORIGINAL PKG

Green Valley Logistics (Imperial County) - Mitigated - Imperial County, Winter

**EMFAC Off-Model Adjustment Factors for Gasoline Light Duty Vehicle to Account for the SAFE Vehicle Rule Applied**

**4.0 Operational Detail - Mobile**

**4.1 Mitigation Measures Mobile**

Category	lb/day															
	ROG	NOx	CO	SO2	Fugitive PM10	Exhaust PM10	PM10 Total	Fugitive PM2.5	Exhaust PM2.5	PM2.5 Total	Bio- CO2	NBio- CO2	Total CO2	CH4	N2O	CO2e
Mitigated	0.0206	0.0168	0.2477	7.0000e-004	10.5142	4.3000e-004	10.5146	1.0632	4.0000e-004	1.0636		73.0773	73.0773	2.5500e-003	2.3200e-003	73.8317
Unmitigated	0.0206	0.0168	0.2477	7.0000e-004	10.5142	4.3000e-004	10.5146	1.0632	4.0000e-004	1.0636		73.0773	73.0773	2.5500e-003	2.3200e-003	73.8317

**4.2 Trip Summary Information**

Land Use	Average Daily Trip Rate			Unmitigated Annual VMT	Mitigated Annual VMT
	Weekday	Saturday	Sunday		
Convenience Market with Gas Pumps	0.00	0.00	0.00		
General Heavy Industry	21.50	21.50	21.50	50,947	50,947
Parking Lot	0.00	0.00	0.00		
Unrefrigerated Warehouse-Rail	0.00	0.00	0.00		
<b>Total</b>	<b>21.50</b>	<b>21.50</b>	<b>21.50</b>	<b>50,947</b>	<b>50,947</b>

**4.3 Trip Type Information**

Land Use	Miles				Trip %				Trip Purpose %			
	H-W or C-W	H-S or C-C	H-O or C-NW	H-W or C-W	H-S or C-C	H-O or C-C	H-O or C-NW	Primary	Diverted	Pass-by		
Convenience Market with Gas	6.70	5.00	8.90	0.80	80.20	19.00	0	0	0	0		
General Heavy Industry	6.70	5.00	8.90	59.00	28.00	13.00	100	0	0	0		
Parking Lot	6.70	5.00	8.90	0.00	0.00	0.00	0	0	0	0		



Green Valley Logistics (Imperial County) - Mitigated - Imperial County, Winter

**EMFAC Off-Model Adjustment Factors for Gasoline Light Duty Vehicle to Account for the SAFE Vehicle Rule Applied**

Land Use	Miles				Trip %				Trip Purpose %			
	H-W or C-W	H-S or C-C	H-O or C-NW	H-W or C-W	H-S or C-C	H-O or C-NW	H-W or C-W	H-S or C-C	H-O or C-NW	Primary	Diverted	Pass-by
Unrefrigerated Warehouse-Rail	6.70	5.00	8.90	59.00	0.00	41.00	0	0	0	0	0	0

**4.4 Fleet Mix**

Land Use	LDA	LDT1	LDT2	MDV	LHD1	LHD2	MHD	HHD	OBUS	UBUS	MCY	SBUS	MH
Convenience Market with Gas Pumps	0.530702	0.059328	0.179664	0.144474	0.026250	0.006790	0.008325	0.016302	0.000941	0.000118	0.022966	0.000752	0.003388
General Heavy Industry	1.000000	0.000000	0.000000	0.000000	0.000000	0.000000	0.000000	0.000000	0.000000	0.000000	0.000000	0.000000	0.000000
Parking Lot	0.530702	0.059328	0.179664	0.144474	0.026250	0.006790	0.008325	0.016302	0.000941	0.000118	0.022966	0.000752	0.003388
Unrefrigerated Warehouse-Rail	0.530702	0.059328	0.179664	0.144474	0.026250	0.006790	0.008325	0.016302	0.000941	0.000118	0.022966	0.000752	0.003388

**5.0 Energy Detail**

Historical Energy Use: N

**5.1 Mitigation Measures Energy**

EEC ORIGINAL PKG

Category	ROG	NOx	CO	SO2	Fugitive PM10	Exhaust PM10	PM10 Total	Fugitive PM2.5	Exhaust PM2.5	PM2.5 Total	Bio- CO2	NBio- CO2	Total CO2	CH4	N2O	CO2e
Natural Gas Mitigated	0.1073	0.9754	0.8194	5.8500e-003	0.0741	0.0741	0.0741	0.0741	0.0741	0.0741	1,170,497.8	1,170,497.8	1,170,497.8	0.0224	0.0215	1,177,453.5
Natural Gas Unmitigated	0.1073	0.9754	0.8194	5.8500e-003	0.0741	0.0741	0.0741	0.0741	0.0741	0.0741	1,170,497.8	1,170,497.8	1,170,497.8	0.0224	0.0215	1,177,453.5

Green Valley Logistics (Imperial County) - Mitigated - Imperial County, Winter

**EMFAC Off-Model Adjustment Factors for Gasoline Light Duty Vehicle to Account for the SAFE Vehicle Rule Applied**

**5.2 Energy by Land Use - NaturalGas**

Unmitigated

Land Use	NaturalGas Use kBtu/yr	lb/day										lb/day						
		ROG	NOx	CO	SO2	Fugitive PM10	Exhaust PM10	PM10 Total	Fugitive PM2.5	Exhaust PM2.5	PM2.5 Total	Bio- CO2	NBio- CO2	Total CO2	CH4	N2O	CO2e	
Convenience Market with Gas Pumps	13.6147	1.5000e-004	1.3300e-003	1.1200e-003	1.0000e-005	1.0000e-004	1.0000e-004	1.0000e-004	1.0000e-004	1.0000e-004	1.0000e-004	1.6017	1.6017	1.6017	3.0000e-005	3.0000e-005	3.0000e-005	1.6113
General Heavy Industry	4428.77	0.0478	0.4342	0.3647	2.6100e-003	0.0330	0.0330	0.0330	0.0330	0.0330	0.0330	521.0314	521.0314	521.0314	9.9900e-003	9.9900e-003	9.9900e-003	524.1277
Parking Lot	0	0.0000	0.0000	0.0000	0.0000	0.0000	0.0000	0.0000	0.0000	0.0000	0.0000	0.0000	0.0000	0.0000	0.0000	0.0000	0.0000	0.0000
Unrefrigerated Warehouse-Rail	5506.85	0.0594	0.5399	0.4535	3.2400e-003	0.0410	0.0410	0.0410	0.0410	0.0410	0.0410	647.8646	647.8646	647.8646	0.0124	0.0119	0.0119	651.7146
<b>Total</b>		<b>0.1073</b>	<b>0.9754</b>	<b>0.8194</b>	<b>5.8600e-003</b>	<b>0.0741</b>	<b>0.0741</b>	<b>0.0741</b>	<b>0.0741</b>	<b>0.0741</b>	<b>0.0741</b>	<b>1,170.497<sub>6</sub></b>	<b>1,170.497<sub>6</sub></b>	<b>1,170.497<sub>6</sub></b>	<b>0.0224</b>	<b>0.0215</b>	<b>0.0215</b>	<b>1,177.453<sub>5</sub></b>

Green Valley Logistics (Imperial County) - Mitigated - Imperial County, Winter

**EMFAC Off-Model Adjustment Factors for Gasoline Light Duty Vehicle to Account for the SAFE Vehicle Rule Applied**

**5.2 Energy by Land Use - Natural Gas**

**Mitigated**

Land Use	Natural Gas Use kBTU/yr	lb/day										lb/day			CO <sub>2e</sub>		
		ROG	NOx	CO	SO <sub>2</sub>	Fugitive PM10	Exhaust PM10	PM10 Total	Fugitive PM2.5	Exhaust PM2.5	PM2.5 Total	Bio- CO2	NBio- CO2	Total CO2		CH <sub>4</sub>	N <sub>2</sub> O
Convenience Market with Gas Pumps	0.0136147	1.5000e-004	1.3300e-003	1.1200e-003	1.0000e-005	1.0000e-004	1.0000e-004	1.0000e-004	1.0000e-004	1.0000e-004	1.0000e-004	1.6017	1.6017	1.6017	3.0000e-005	3.0000e-005	1.6113
General Heavy Industry	4.42877	0.0478	0.4342	0.3647	2.6100e-003	0.0330	0.0330	0.0330	0.0330	0.0330	0.0330	521.0314	521.0314	521.0314	9.9900e-003	9.9900e-003	524.1277
Parking Lot	0	0.0000	0.0000	0.0000	0.0000	0.0000	0.0000	0.0000	0.0000	0.0000	0.0000	0.0000	0.0000	0.0000	0.0000	0.0000	0.0000
Unrefrigerated Warehouse-Rail	5.50685	0.0594	0.5399	0.4535	3.2400e-003	0.0410	0.0410	0.0410	0.0410	0.0410	0.0410	647.8646	647.8646	647.8646	0.0124	0.0119	651.7146
<b>Total</b>		<b>0.1073</b>	<b>0.9754</b>	<b>0.8194</b>	<b>5.8600e-003</b>	<b>0.0741</b>	<b>0.0741</b>	<b>0.0741</b>	<b>0.0741</b>	<b>0.0741</b>	<b>0.0741</b>	<b>1,170.4978</b>	<b>1,170.4978</b>	<b>1,170.4978</b>	<b>0.0224</b>	<b>0.0215</b>	<b>1,177.4535</b>

**6.0 Area Detail**

**6.0 Mitigation Measures Area**

ORIGINAL PKG

Green Valley Logistics (Imperial County) - Mitigated - Imperial County, Winter

**EMFAC Off-Model Adjustment Factors for Gasoline Light Duty Vehicle to Account for the SAFE Vehicle Rule Applied**

Category	ROG	NOx	CO	SO2	Fugitive PM10	Exhaust PM10	PM10 Total	Fugitive PM2.5	Exhaust PM2.5	PM2.5 Total	Bio- CO2	NBio- CO2	Total CO2	CH4	N2O	CO2e
lb/day																
Mitigated	26.6059	1.3100e-003	0.1442	1.0000e-005	5.1000e-004	5.1000e-004	5.1000e-004	5.1000e-004	5.1000e-004	5.1000e-004		0.3099	0.3099	8.1000e-004		0.3301
Unmitigated	26.6059	1.3100e-003	0.1442	1.0000e-005	5.1000e-004	5.1000e-004	5.1000e-004	5.1000e-004	5.1000e-004	5.1000e-004		0.3099	0.3099	8.1000e-004		0.3301

**6.2 Area by SubCategory**

Unmitigated

SubCategory	ROG	NOx	CO	SO2	Fugitive PM10	Exhaust PM10	PM10 Total	Fugitive PM2.5	Exhaust PM2.5	PM2.5 Total	Bio- CO2	NBio- CO2	Total CO2	CH4	N2O	CO2e
lb/day																
Architectural Coating	4.0247				0.0000	0.0000	0.0000	0.0000	0.0000	0.0000			0.0000			0.0000
Consumer Products	22.5679				0.0000	0.0000	0.0000	0.0000	0.0000	0.0000			0.0000			0.0000
Landscaping	0.0133	1.3100e-003	0.1442	1.0000e-005	5.1000e-004	5.1000e-004	5.1000e-004	5.1000e-004	5.1000e-004	5.1000e-004		0.3099	0.3099	8.1000e-004		0.3301
<b>Total</b>	<b>26.6059</b>	<b>1.3100e-003</b>	<b>0.1442</b>	<b>1.0000e-005</b>	<b>5.1000e-004</b>	<b>5.1000e-004</b>	<b>5.1000e-004</b>	<b>5.1000e-004</b>	<b>5.1000e-004</b>	<b>5.1000e-004</b>		<b>0.3099</b>	<b>0.3099</b>	<b>8.1000e-004</b>		<b>0.3301</b>

FEC ORIGINAL PKG



Green Valley Logistics (Imperial County) - Mitigated - Imperial County, Winter

**EMFAC Off-Model Adjustment Factors for Gasoline Light Duty Vehicle to Account for the SAFE Vehicle Rule Applied**

**6.2 Area by SubCategory**

Mitigated

SubCategory	ROG	NOx	CO	SO2	Fugitive PM10	Exhaust PM10	PM10 Total	Fugitive PM2.5	Exhaust PM2.5	PM2.5 Total	Bio- CO2	NBio- CO2	Total CO2	CH4	N2O	CO2e
lb/day																
Architectural Coating	4.0247					0.0000	0.0000		0.0000	0.0000			0.0000			0.0000
Consumer Products	22.5679					0.0000	0.0000		0.0000	0.0000			0.0000			0.0000
Landscaping	0.0133	1.3100e-003	0.1442	1.0000e-005		5.1000e-004	5.1000e-004		5.1000e-004	5.1000e-004		0.3099	0.3099	8.1000e-004		0.3301
<b>Total</b>	<b>26.6059</b>	<b>1.3100e-003</b>	<b>0.1442</b>	<b>1.0000e-005</b>		<b>5.1000e-004</b>	<b>5.1000e-004</b>		<b>5.1000e-004</b>	<b>5.1000e-004</b>		<b>0.3099</b>	<b>0.3099</b>	<b>8.1000e-004</b>		<b>0.3301</b>

**7.0 Water Detail**

**7.1 Mitigation Measures Water**

**EEC ORIGINAL PKG**

Green Valley Logistics (Imperial County) - Mitigated - Imperial County, Winter

**EMFAC Off-Model Adjustment Factors for Gasoline Light Duty Vehicle to Account for the SAFE Vehicle Rule Applied**

**8.0 Waste Detail**

**8.1 Mitigation Measures Waste**

**9.0 Operational Offroad**

Equipment Type	Number	Hours/Day	Days/Year	Horse Power	Load Factor	Fuel Type
----------------	--------	-----------	-----------	-------------	-------------	-----------

**10.0 Stationary Equipment**

**Fire Pumps and Emergency Generators**

Equipment Type	Number	Hours/Day	Hours/Year	Horse Power	Load Factor	Fuel Type
----------------	--------	-----------	------------	-------------	-------------	-----------

**Boilers**

Equipment Type	Number	Heat Input/Day	Heat Input/Year	Boiler Rating	Fuel Type
----------------	--------	----------------	-----------------	---------------	-----------

**User Defined Equipment**

Equipment Type	Number
----------------	--------

**11.0 Vegetation**

Green Valley Logistics (Imperial County) - Mitigated - Imperial County, Annual

**EMFAC Off-Model Adjustment Factors for Gasoline Light Duty Vehicle to Account for the SAFE Vehicle Rule Applied**

**Green Valley Logistics (Imperial County) - Mitigated**

Imperial County, Annual

**1.0 Project Characteristics**

**1.1 Land Usage**

Land Uses	Size	Metric	Lot Acreage	Floor Surface Area	Population
General Heavy Industry	50.00	1000sqft	207.00	50,000.00	0
Unrefrigerated Warehouse-Rail	1,000.00	1000sqft	64.00	1,000,000.00	0
Parking Lot	350.00	Space	4.00	140,000.00	0
Convenience Market with Gas Pumps	16.00	Pump	9.50	2,258.80	0

**1.2 Other Project Characteristics**

Urbanization	Urban	Wind Speed (m/s)	3.4	Precipitation Freq (Days)	12
Climate Zone	15			Operational Year	2025

Utility Company Imperial Irrigation District

CO2 Intensity (lb/MW/hr)	189.98	CH4 Intensity (lb/MW/hr)	0.033	N2O Intensity (lb/MW/hr)	0.004
--------------------------	--------	--------------------------	-------	--------------------------	-------

**1.3 User Entered Comments & Non-Default Data**

Project Characteristics -

Land Use - 284.5 acres site

Construction Phase - Construction Schedule

Off-road Equipment - CE

Trips and VMT - Project would use 24,250 trucks to deliver 24CY of stone material per truck during Grading and Building Construction. Per Mitigation Measure ACM-1... all haul routes and worker trips to and from the site shall be 100% paved.

Off-road Fugitive Dust - The Project assumes 90% paved. As a mitigation measure, the Project applicant shall prepare a Haul Route Plan which needs to be 100% paved and all worker trips shall utilize 100% paved roadways.

Grading - 1,000 CY of export grubbed material

Architectural Coating -







Green Valley Logistics (Imperial County) - Mitigated - Imperial County, Annual

**EMFAC Off-Model Adjustment Factors for Gasoline Light Duty Vehicle to Account for the SAFE Vehicle Rule Applied**

tblFleetMix	MCY	0.02	0.00
tblFleetMix	MDV	0.14	0.00
tblFleetMix	MH	3.3880e-003	0.00
tblFleetMix	MHD	8.3250e-003	0.00
tblFleetMix	OBUS	9.4100e-004	0.00
tblFleetMix	SBUS	7.5200e-004	0.00
tblFleetMix	UBUS	1.1800e-004	0.00
tblGrading	MaterialExported	0.00	1,000.00
tblLandUse	LotAcreage	1.15	207.00
tblLandUse	LotAcreage	22.96	64.00
tblLandUse	LotAcreage	3.15	4.00
tblLandUse	LotAcreage	0.05	9.50
tblOffRoadEquipment	OffRoadEquipmentUnitAmount	1.00	2.00
tblOnRoadDust	HaulingPercentPave	50.00	100.00
tblOnRoadDust	HaulingPercentPave	50.00	100.00
tblOnRoadDust	HaulingPercentPave	50.00	100.00
tblOnRoadDust	HaulingPercentPave	50.00	100.00
tblOnRoadDust	HaulingPercentPave	50.00	100.00
tblOnRoadDust	VendorPercentPave	50.00	100.00
tblOnRoadDust	VendorPercentPave	50.00	100.00
tblOnRoadDust	VendorPercentPave	50.00	100.00
tblOnRoadDust	VendorPercentPave	50.00	100.00
tblOnRoadDust	VendorPercentPave	50.00	100.00
tblOnRoadDust	WorkerPercentPave	50.00	100.00
tblOnRoadDust	WorkerPercentPave	50.00	100.00
tblOnRoadDust	WorkerPercentPave	50.00	100.00
tblOnRoadDust	WorkerPercentPave	50.00	100.00
tblOnRoadDust	WorkerPercentPave	50.00	100.00
tblRoadDust	RoadPercentPave	50	90

**FEC ORIGINAL PKG**

Green Valley Logistics (Imperial County) - Mitigated - Imperial County, Annual

**EMFAC Off-Model Adjustment Factors for Gasoline Light Duty Vehicle to Account for the SAFE Vehicle Rule Applied**

tblSolidWaste	SolidWasteGenerationRate	940.00	188.00
tblTripsAndVMT	HaulingTripNumber	0.00	2,965.35
tblTripsAndVMT	HaulingTripNumber	0.00	21,284.65
tblVehicleTrips	DV_TP	21.00	0.00
tblVehicleTrips	DV_TP	5.00	0.00
tblVehicleTrips	DV_TP	5.00	0.00
tblVehicleTrips	PB_TP	65.00	0.00
tblVehicleTrips	PB_TP	3.00	0.00
tblVehicleTrips	PB_TP	3.00	0.00
tblVehicleTrips	PR_TP	14.00	0.00
tblVehicleTrips	PR_TP	92.00	100.00
tblVehicleTrips	PR_TP	92.00	0.00
tblVehicleTrips	ST_TR	322.50	0.00
tblVehicleTrips	ST_TR	6.42	0.43
tblVehicleTrips	ST_TR	1.74	0.00
tblVehicleTrips	SU_TR	322.50	0.00
tblVehicleTrips	SU_TR	5.09	0.43
tblVehicleTrips	SU_TR	1.74	0.00
tblVehicleTrips	WD_TR	322.50	0.00
tblVehicleTrips	WD_TR	3.93	0.43
tblVehicleTrips	WD_TR	1.74	0.00
tblWater	IndoorWaterUseRate	167,314.87	0.00
tblWater	IndoorWaterUseRate	11,562,500.00	0.00
tblWater	IndoorWaterUseRate	231,250,000.00	12,000,000.00
tblWater	OutdoorWaterUseRate	102,547.82	0.00
tblWater	OutdoorWaterUseRate	0.00	46,650,000.00

FEC ORIGINAL PKG

**2.0 Emissions Summary**



Green Valley Logistics (Imperial County) - Mitigated - Imperial County, Annual

**EMFAC Off-Model Adjustment Factors for Gasoline Light Duty Vehicle to Account for the SAFE Vehicle Rule Applied**

**2.1 Overall Construction**

Unmitigated Construction

Year	tons/yr											MT/yr				
	ROG	NOx	CO	SO2	Fugitive PM10	Exhaust PM10	PM10 Total	Fugitive PM2.5	Exhaust PM2.5	PM2.5 Total	Bio- CO2	NBio- CO2	Total CO2	CH4	N2O	CO2e
2024	4.8486	4.6892	4.7374	0.0168	1.2534	0.1418	1.3952	0.4746	0.1318	0.6064	0.0000	1,556.7915	1,556.7915	0.1656	0.1280	1,599.0603
2025	3.2764	1.9522	2.2374	8.7900e-003	0.3813	0.0459	0.4272	0.1042	0.0430	0.1472	0.0000	819.6773	819.6773	0.0613	0.0747	843.4787
Maximum	4.8486	4.6892	4.7374	0.0168	1.2534	0.1418	1.3952	0.4746	0.1318	0.6064	0.0000	1,556.7915	1,556.7915	0.1656	0.1280	1,599.0603

Mitigated Construction

Year	tons/yr											MT/yr				
	ROG	NOx	CO	SO2	Fugitive PM10	Exhaust PM10	PM10 Total	Fugitive PM2.5	Exhaust PM2.5	PM2.5 Total	Bio- CO2	NBio- CO2	Total CO2	CH4	N2O	CO2e
2024	4.6939	4.6514	5.4075	0.0168	0.8962	0.0425	0.9387	0.3044	0.0417	0.3461	0.0000	1,556.7909	1,556.7909	0.1656	0.1280	1,599.0597
2025	3.2344	2.1422	2.4638	8.7900e-003	0.3813	0.0211	0.4024	0.1042	0.0206	0.1249	0.0000	819.6771	819.6771	0.0613	0.0747	843.4784
Maximum	4.6939	4.6514	5.4075	0.0168	0.8962	0.0425	0.9387	0.3044	0.0417	0.3461	0.0000	1,556.7909	1,556.7909	0.1656	0.1280	1,599.0597

EEC ORIGINAL PKG



Green Valley Logistics (Imperial County) - Mitigated - Imperial County, Annual

**EMFAC Off-Model Adjustment Factors for Gasoline Light Duty Vehicle to Account for the SAFE Vehicle Rule Applied**

	ROG	NOx	CO	SO2	Fugitive PM10	Exhaust PM10	PM10 Total	Fugitive PM2.5	Exhaust PM2.5	PM2.5 Total	Bio- CO2	NBio-CO2	Total CO2	CH4	N2O	CO2e
Percent Reduction	2.42	-2.29	-12.85	0.00	21.85	66.11	26.41	29.41	64.37	37.51	0.00	0.00	0.00	0.00	0.00	0.00
Quarter	Start Date	End Date	Maximum Unmitigated ROG + NOX (tons/quarter)													
3	11-15-2023	2-14-2024	0.6996													
4	2-15-2024	5-14-2024	1.5511													
5	5-15-2024	8-14-2024	2.1860													
6	8-15-2024	11-14-2024	3.3266													
7	11-15-2024	2-14-2025	3.3116													
8	2-15-2025	5-14-2025	3.0446													
9	5-15-2025	8-14-2025	0.5380													
		Highest	3.3266													
			Maximum Mitigated ROG + NOX (tons/quarter)													
			0.5210													
			1.4556													
			2.2212													
			3.3621													
			3.3671													
			3.1183													
			0.5753													
			3.3671													

Green Valley Logistics (Imperial County) - Mitigated - Imperial County, Annual

**EMFAC Off-Model Adjustment Factors for Gasoline Light Duty Vehicle to Account for the SAFE Vehicle Rule Applied**

**2.2 Overall Operational**  
**Unmitigated Operational**

Category	tons/yr										MT/yr					
	ROG	NOx	CO	SO2	Fugitive PM10	Exhaust PM10	PM10 Total	Fugitive PM2.5	Exhaust PM2.5	PM2.5 Total	Bio- CO2	NBio- CO2	Total CO2	CH4	N2O	CO2e
Area	4.8543	1.2000e-004	0.0130	0.0000		5.0000e-005	5.0000e-005		5.0000e-005	5.0000e-005	0.0000	0.0253	0.0253	7.0000e-005	0.0000	0.0270
Energy	0.0196	0.1780	0.1495	1.0700e-003		0.0135	0.0135		0.0135	0.0135	0.0000	443.0391	443.0391	0.0470	8.8000e-003	446.8369
Mobile	4.6100e-003	2.8700e-003	0.0481	1.4000e-004	1.9135	8.0000e-005	1.9135	0.1935	7.0000e-005	0.1936	0.0000	13.0005	13.0005	3.9000e-004	3.8000e-004	13.1219
Waste						0.0000	0.0000		0.0000	0.0000	50.7477	0.0000	50.7477	2.9991	0.0000	125.7254
Water						0.0000	0.0000		0.0000	0.0000	3.8071	58.1269	61.9339	0.4011	0.0105	75.0780
<b>Total</b>	<b>4.8785</b>	<b>0.1811</b>	<b>0.2106</b>	<b>1.2100e-003</b>	<b>1.9135</b>	<b>0.0137</b>	<b>1.9271</b>	<b>0.1935</b>	<b>0.0137</b>	<b>0.2071</b>	<b>54.5548</b>	<b>514.1918</b>	<b>568.7466</b>	<b>3.4477</b>	<b>0.0196</b>	<b>660.7892</b>

Green Valley Logistics (Imperial County) - Mitigated - Imperial County, Annual

**EMFAC Off-Model Adjustment Factors for Gasoline Light Duty Vehicle to Account for the SAFE Vehicle Rule Applied**

**2.2 Overall Operational**

**Mitigated Operational**

Category	tons/yr											MT/yr				
	ROG	NOx	CO	SO2	Fugitive PM10	Exhaust PM10	PM10 Total	Fugitive PM2.5	Exhaust PM2.5	PM2.5 Total	Bio- CO2	NBio- CO2	Total CO2	CH4	N2O	CO2e
Area	4.8543	1.2000e-004	0.0130	0.0000		5.0000e-005	5.0000e-005		5.0000e-005	5.0000e-005	0.0000	0.0253	0.0253	7.0000e-005	0.0000	0.0270
Energy	0.0196	0.1780	0.1495	1.0700e-003		0.0135	0.0135		0.0135	0.0135	0.0000	443.0391	443.0391	0.0470	8.8000e-003	446.8369
Mobile	4.6100e-003	2.9700e-003	0.0481	1.4000e-004	1.9135	8.0000e-005	1.9135	0.1935	7.0000e-005	0.1936	0.0000	13.0005	13.0005	3.9000e-004	3.8000e-004	13.1219
Waste						0.0000	0.0000		0.0000	0.0000	50.7477	0.0000	50.7477	2.9991	0.0000	125.7254
Water						0.0000	0.0000		0.0000	0.0000	3.8071	58.1269	61.9339	0.4011	0.0105	75.0780
<b>Total</b>	<b>4.8785</b>	<b>0.1811</b>	<b>0.2106</b>	<b>1.2100e-003</b>	<b>1.9135</b>	<b>0.0137</b>	<b>1.9271</b>	<b>0.1935</b>	<b>0.0137</b>	<b>0.2071</b>	<b>54.5548</b>	<b>514.1918</b>	<b>568.7466</b>	<b>3.4477</b>	<b>0.0196</b>	<b>660.7892</b>

Percent Reduction	ROG	NOx	CO	SO2	Fugitive PM10	Exhaust PM10	PM10 Total	Fugitive PM2.5	Exhaust PM2.5	PM2.5 Total	Bio- CO2	NBio- CO2	Total CO2	CH4	N2O	CO2e
	0.00	0.00	0.00	0.00	0.00	0.00	0.00	0.00	0.00	0.00	0.00	0.00	0.00	0.00	0.00	0.00

**3.0 Construction Detail**

**Construction Phase**

Phase Number	Phase Name	Phase Type	Start Date	End Date	Num Days Week	Num Days	Phase Description
1	Site Preparation	Site Preparation	1/1/2024	3/1/2024	5	45	
2	Grading	Grading	2/1/2024	4/3/2024	5	45	
3	Building Construction	Building Construction	4/4/2024	6/30/2025	5	323	

Green Valley Logistics (Imperial County) - Mitigated - Imperial County, Annual

**EMFAC Off-Model Adjustment Factors for Gasoline Light Duty Vehicle to Account for the SAFE Vehicle Rule Applied**

4	Paving	4/4/2024	5/8/2024	5	25
5	Architectural Coating	7/1/2024	5/9/2025	5	225

**Acres of Grading (Site Preparation Phase): 67.5**

**Acres of Grading (Grading Phase): 135**

**Acres of Paving: 4**

**Residential Indoor: 0; Residential Outdoor: 0; Non-Residential Indoor: 1,578,388; Non-Residential Outdoor: 526,129; Striped Parking Area: 8,400 (Architectural Coating – sqft)**

**OffRoad Equipment**

Phase Name	Offroad Equipment Type	Amount	Usage Hours	Horse Power	Load Factor
Site Preparation	Rubber Tired Dozers	3	8.00	247	0.40
Site Preparation	Tractors/Loaders/Backhoes	4	8.00	97	0.37
Grading	Excavators	2	8.00	158	0.38
Grading	Graders	1	8.00	187	0.41
Grading	Rubber Tired Dozers	1	8.00	247	0.40
Grading	Scrapers	2	8.00	367	0.48
Grading	Tractors/Loaders/Backhoes	2	8.00	97	0.37
Building Construction	Aerial Lifts	2	8.00	63	0.31
Building Construction	Cranes	2	7.00	231	0.29
Building Construction	Rough Terrain Forklifts	2	8.00	100	0.40
Building Construction	Tractors/Loaders/Backhoes	3	7.00	97	0.37
Building Construction	Welders	1	8.00	46	0.45
Paving	Pavers	2	8.00	130	0.42
Paving	Paving Equipment	2	8.00	132	0.36
Paving	Rollers	2	8.00	80	0.38
Architectural Coating	Air Compressors	1	6.00	78	0.48

**Trips and VMT**



Green Valley Logistics (Imperial County) - Mitigated - Imperial County, Annual

**EMFAC Off-Model Adjustment Factors for Gasoline Light Duty Vehicle to Account for the SAFE Vehicle Rule Applied**

Phase Name	Offroad Equipment Count	Worker Trip Number	Vendor Trip Number	Hauling Trip Number	Worker Trip Length	Vendor Trip Length	Hauling Trip Length	Worker Vehicle Class	Vendor Vehicle Class	Hauling Vehicle Class
Site Preparation	7	18.00	0.00	125.00	7.30	8.90	20.00	LD_Mix	HDT_Mix	HHDT
Grading	8	20.00	0.00	2,965.35	7.30	8.90	20.00	LD_Mix	HDT_Mix	HHDT
Building Construction	10	501.00	195.00	21,284.65	7.30	8.90	20.00	LD_Mix	HDT_Mix	HHDT
Paving	6	15.00	0.00	0.00	7.30	8.90	20.00	LD_Mix	HDT_Mix	HHDT
Architectural Coating	1	100.00	0.00	0.00	7.30	8.90	20.00	LD_Mix	HDT_Mix	HHDT

**3.1 Mitigation Measures Construction**

- Use Cleaner Engines for Construction Equipment
- Use DPF for Construction Equipment
- Water Exposed Area
- Water Unpaved Roads
- Reduce Vehicle Speed on Unpaved Roads

**3.2 Site Preparation - 2024**

**Unmitigated Construction On-Site**

EEC ORIGINAL PKG

Category	ROG	NOx	CO	SO2	Fugitive PM10	Exhaust PM10	PM10 Total	Fugitive PM2.5	Exhaust PM2.5	PM2.5 Total	Bio- CO2	NEBio- CO2	Total CO2	CH4	N2O	CO2e
Fugitive Dust					0.4424	0.0000	0.4424	0.2273	0.0000	0.2273	0.0000	0.0000	0.0000	0.0000	0.0000	0.0000
Off-Road	0.0599	0.6115	0.4126	8.6000e-004	0.0277	0.0277	0.0277	0.0255	0.0255	0.0255	0.0000	75.2784	75.2784	0.0244	0.0000	75.8871
<b>Total</b>	<b>0.0599</b>	<b>0.6115</b>	<b>0.4126</b>	<b>8.6000e-004</b>	<b>0.4424</b>	<b>0.0277</b>	<b>0.4700</b>	<b>0.2273</b>	<b>0.0255</b>	<b>0.2528</b>	<b>0.0000</b>	<b>75.2784</b>	<b>75.2784</b>	<b>0.0244</b>	<b>0.0000</b>	<b>75.8871</b>

Green Valley Logistics (Imperial County) - Mitigated - Imperial County, Annual

**EMFAC Off-Model Adjustment Factors for Gasoline Light Duty Vehicle to Account for the SAFE Vehicle Rule Applied**

**3.2 Site Preparation - 2024**

Unmitigated Construction Off-Site

Category	tons/yr										MT/yr					
	ROG	NOx	CO	SO2	Fugitive PM10	Exhaust PM10	PM10 Total	Fugitive PM2.5	Exhaust PM2.5	PM2.5 Total	Bio- CO2	NBio- CO2	Total CO2	CH4	N2O	CO2e
Hauling	1.4000e-004	6.4800e-003	1.8200e-003	3.0000e-005	1.0900e-003	8.0000e-005	1.1700e-003	3.0000e-004	7.0000e-005	3.7000e-004	0.0000	3.1914	3.1914	1.0000e-005	5.0000e-004	3.3411
Vendor	0.0000	0.0000	0.0000	0.0000	0.0000	0.0000	0.0000	0.0000	0.0000	0.0000	0.0000	0.0000	0.0000	0.0000	0.0000	0.0000
Worker	1.2900e-003	6.7000e-004	8.0900e-003	2.0000e-005	2.2300e-003	1.0000e-005	2.2500e-003	5.9000e-004	1.0000e-005	6.0000e-004	0.0000	1.7488	1.7488	7.0000e-005	6.0000e-005	1.7679
<b>Total</b>	<b>1.4300e-003</b>	<b>7.1500e-003</b>	<b>9.9100e-003</b>	<b>5.0000e-005</b>	<b>3.3200e-003</b>	<b>9.0000e-005</b>	<b>3.4200e-003</b>	<b>8.9000e-004</b>	<b>8.0000e-005</b>	<b>9.7000e-004</b>	<b>0.0000</b>	<b>4.9402</b>	<b>4.9402</b>	<b>8.0000e-005</b>	<b>5.6000e-004</b>	<b>5.1090</b>

**Mitigated Construction On-Site**

Category	tons/yr										MT/yr					
	ROG	NOx	CO	SO2	Fugitive PM10	Exhaust PM10	PM10 Total	Fugitive PM2.5	Exhaust PM2.5	PM2.5 Total	Bio- CO2	NBio- CO2	Total CO2	CH4	N2O	CO2e
Fugitive Dust					0.1991	0.0000	0.1991	0.1023	0.0000	0.1023	0.0000	0.0000	0.0000	0.0000	0.0000	0.0000
Off-Road	0.0210	0.4290	0.5166	8.6000e-004	3.1900e-003	3.1900e-003	3.1900e-003	3.1900e-003	3.1900e-003	3.1900e-003	0.0000	75.2783	75.2783	0.0244	0.0000	75.8870
<b>Total</b>	<b>0.0210</b>	<b>0.4290</b>	<b>0.5166</b>	<b>8.6000e-004</b>	<b>0.1991</b>	<b>3.1900e-003</b>	<b>0.2023</b>	<b>0.1023</b>	<b>3.1900e-003</b>	<b>0.1055</b>	<b>0.0000</b>	<b>75.2783</b>	<b>75.2783</b>	<b>0.0244</b>	<b>0.0000</b>	<b>75.8870</b>

Green Valley Logistics (Imperial County) - Mitigated - Imperial County, Annual

**EMFAC Off-Model Adjustment Factors for Gasoline Light Duty Vehicle to Account for the SAFE Vehicle Rule Applied**

**3.2 Site Preparation - 2024**

**Mitigated Construction Off-Site**

Category	tons/yr											MT/yr				
	ROG	NOx	CO	SO2	Fugitive PM10	Exhaust PM10	PM10 Total	Fugitive PM2.5	Exhaust PM2.5	PM2.5 Total	Bio- CO2	NBio- CO2	Total CO2	CH4	N2O	CO2e
Hauling	1.4000e-004	6.4800e-003	1.8200e-003	3.0000e-005	1.0900e-003	8.0000e-005	1.1700e-003	3.0000e-004	7.0000e-005	3.7000e-004	0.0000	3.1914	3.1914	1.0000e-005	5.0000e-004	3.3411
Vendor	0.0000	0.0000	0.0000	0.0000	0.0000	0.0000	0.0000	0.0000	0.0000	0.0000	0.0000	0.0000	0.0000	0.0000	0.0000	0.0000
Worker	1.2900e-003	6.7000e-004	8.0900e-003	2.0000e-005	2.2300e-003	1.0000e-005	2.2500e-003	5.9000e-004	1.0000e-005	6.0000e-004	0.0000	1.7488	1.7488	7.0000e-005	6.0000e-005	1.7679
<b>Total</b>	<b>1.4300e-003</b>	<b>7.1500e-003</b>	<b>9.9100e-003</b>	<b>5.0000e-005</b>	<b>3.3200e-003</b>	<b>9.0000e-005</b>	<b>3.4200e-003</b>	<b>8.9000e-004</b>	<b>8.0000e-005</b>	<b>9.7000e-004</b>	<b>0.0000</b>	<b>4.9402</b>	<b>4.9402</b>	<b>8.0000e-005</b>	<b>5.6000e-004</b>	<b>5.1090</b>

**3.3 Grading - 2024**

**Unmitigated Construction On-Site**

Category	tons/yr											MT/yr				
	ROG	NOx	CO	SO2	Fugitive PM10	Exhaust PM10	PM10 Total	Fugitive PM2.5	Exhaust PM2.5	PM2.5 Total	Bio- CO2	NBio- CO2	Total CO2	CH4	N2O	CO2e
Fugitive Dust					0.2071	0.0000	0.2071	0.0822	0.0000	0.0822	0.0000	0.0000	0.0000	0.0000	0.0000	0.0000
Off-Road	0.0724	0.7285	0.6238	1.4000e-003		0.0301	0.0301	0.0276	0.0276	0.0276	0.0000	122.6689	122.6689	0.0397	0.0000	123.6608
<b>Total</b>	<b>0.0724</b>	<b>0.7285</b>	<b>0.6238</b>	<b>1.4000e-003</b>	<b>0.2071</b>	<b>0.0301</b>	<b>0.2371</b>	<b>0.0822</b>	<b>0.0276</b>	<b>0.1099</b>	<b>0.0000</b>	<b>122.6689</b>	<b>122.6689</b>	<b>0.0397</b>	<b>0.0000</b>	<b>123.6608</b>

**FEC ORIGINAL PKG**

Green Valley Logistics (Imperial County) - Mitigated - Imperial County, Annual

**EMFAC Off-Model Adjustment Factors for Gasoline Light Duty Vehicle to Account for the SAFE Vehicle Rule Applied**

**3.3 Grading - 2024**

**Unmitigated Construction Off-Site**

Category	tons/yr										MT/yr					
	ROG	NOx	CO	SO2	Fugitive PM10	Exhaust PM10	PM10 Total	Fugitive PM2.5	Exhaust PM2.5	PM2.5 Total	Bio- CO2	NBio- CO2	Total CO2	CH4	N2O	CO2e
Hauling	3.4400e-003	0.1537	0.0432	7.9000e-004	0.0259	1.8000e-003	0.0277	7.1000e-003	1.7300e-003	8.8200e-003	0.0000	75.7248	75.7248	2.1000e-004	0.0119	79.2774
Vendor	0.0000	0.0000	0.0000	0.0000	0.0000	0.0000	0.0000	0.0000	0.0000	0.0000	0.0000	0.0000	0.0000	0.0000	0.0000	0.0000
Worker	1.4400e-003	7.4000e-004	8.9900e-003	2.0000e-005	2.4800e-003	1.0000e-005	2.4900e-003	6.6000e-004	1.0000e-005	6.7000e-004	0.0000	1.9431	1.9431	7.0000e-005	7.0000e-005	1.9644
<b>Total</b>	<b>4.8800e-003</b>	<b>0.1544</b>	<b>0.0522</b>	<b>8.1000e-004</b>	<b>0.0283</b>	<b>1.8100e-003</b>	<b>0.0301</b>	<b>7.7600e-003</b>	<b>1.7400e-003</b>	<b>9.4900e-003</b>	<b>0.0000</b>	<b>77.6679</b>	<b>77.6679</b>	<b>2.8000e-004</b>	<b>0.0120</b>	<b>81.2418</b>

**Mitigated Construction On-Site**

Category	tons/yr										MT/yr					
	ROG	NOx	CO	SO2	Fugitive PM10	Exhaust PM10	PM10 Total	Fugitive PM2.5	Exhaust PM2.5	PM2.5 Total	Bio- CO2	NBio- CO2	Total CO2	CH4	N2O	CO2e
Exhaustive Dust					0.0932	0.0000	0.0932	0.0370	0.0000	0.0370	0.0000	0.0000	0.0000	0.0000	0.0000	0.0000
Off-Road	0.0343	0.6745	0.8263	1.4000e-003		4.3900e-003	4.3900e-003		4.3900e-003	4.3900e-003	0.0000	122.6688	122.6688	0.0397	0.0000	123.6606
<b>Total</b>	<b>0.0343</b>	<b>0.6745</b>	<b>0.8263</b>	<b>1.4000e-003</b>	<b>0.0932</b>	<b>4.3900e-003</b>	<b>0.0976</b>	<b>0.0370</b>	<b>4.3900e-003</b>	<b>0.0414</b>	<b>0.0000</b>	<b>122.6688</b>	<b>122.6688</b>	<b>0.0397</b>	<b>0.0000</b>	<b>123.6606</b>



Green Valley Logistics (Imperial County) - Mitigated - Imperial County, Annual

**EMFAC Off-Model Adjustment Factors for Gasoline Light Duty Vehicle to Account for the SAFE Vehicle Rule Applied**

**3.3 Grading - 2024**

**Mitigated Construction Off-Site**

Category	tons/yr											MT/yr				
	ROG	NOx	CO	SO2	Fugitive PM10	Exhaust PM10	PM10 Total	Fugitive PM2.5	Exhaust PM2.5	PM2.5 Total	Bio- CO2	NBio- CO2	Total CO2	CH4	N2O	CO2e
Hauling	3.4400e-003	0.1537	0.0432	7.9000e-004	0.0259	1.8000e-003	0.0277	7.1000e-003	1.7300e-003	8.8200e-003	0.0000	75.7248	75.7248	2.1000e-004	0.0119	79.2774
Vendor	0.0000	0.0000	0.0000	0.0000	0.0000	0.0000	0.0000	0.0000	0.0000	0.0000	0.0000	0.0000	0.0000	0.0000	0.0000	0.0000
Worker	1.4400e-003	7.4000e-004	6.9900e-003	2.0000e-005	2.4800e-003	1.0000e-005	2.4900e-003	6.6000e-004	1.0000e-005	6.7000e-004	0.0000	1.9431	1.9431	7.0000e-005	7.0000e-005	1.9644
<b>Total</b>	<b>4.8800e-003</b>	<b>0.1544</b>	<b>0.0522</b>	<b>8.1000e-004</b>	<b>0.0283</b>	<b>1.8100e-003</b>	<b>0.0301</b>	<b>7.7600e-003</b>	<b>1.7400e-003</b>	<b>9.4900e-003</b>	<b>0.0000</b>	<b>77.6679</b>	<b>77.6679</b>	<b>2.8000e-004</b>	<b>0.0120</b>	<b>81.2418</b>

**3.4 Building Construction - 2024**

**Unmitigated Construction On-Site**

Category	tons/yr											MT/yr				
	ROG	NOx	CO	SO2	Fugitive PM10	Exhaust PM10	PM10 Total	Fugitive PM2.5	Exhaust PM2.5	PM2.5 Total	Bio- CO2	NBio- CO2	Total CO2	CH4	N2O	CO2e
Off-Road	0.1424	1.4616	1.6880	3.0200e-003		0.0560	0.0560		0.0519	0.0519	0.0000	261.3720	261.3720	0.0805	0.0000	263.3843
<b>Total</b>	<b>0.1424</b>	<b>1.4616</b>	<b>1.6880</b>	<b>3.0200e-003</b>		<b>0.0560</b>	<b>0.0560</b>		<b>0.0519</b>	<b>0.0519</b>	<b>0.0000</b>	<b>261.3720</b>	<b>261.3720</b>	<b>0.0805</b>	<b>0.0000</b>	<b>263.3843</b>

EFC ORIGINAL FKG

Green Valley Logistics (Imperial County) - Mitigated - Imperial County, Annual

**EMFAC Off-Model Adjustment Factors for Gasoline Light Duty Vehicle to Account for the SAFE Vehicle Rule Applied**

**3.4 Building Construction - 2024**

**Unmitigated Construction Off-Site**

Category	tons/yr										MT/yr					
	ROG	NOx	CO	SO2	Fugitive PM10	Exhaust PM10	PM10 Total	Fugitive PM2.5	Exhaust PM2.5	PM2.5 Total	Bio- CO2	NBio- CO2	Total CO2	CH4	N2O	CO2e
Hauling	0.0148	0.6623	0.1863	3.4000e-003	0.1114	7.7800e-003	0.1192	0.0306	7.4400e-003	0.0380	0.0000	326.3922	326.3922	9.1000e-004	0.0513	341.7047
Vendor	0.0374	0.7732	0.3561	4.2700e-003	0.1554	6.9800e-003	0.1624	0.0448	6.6800e-003	0.0515	0.0000	407.4348	407.4348	1.7900e-003	0.0561	424.1925
Worker	0.1551	0.0800	0.9707	2.2400e-003	0.2681	1.3400e-003	0.2694	0.0712	1.2300e-003	0.0724	0.0000	209.8438	209.8438	7.8500e-003	7.0500e-003	212.1400
<b>Total</b>	<b>0.2073</b>	<b>1.5155</b>	<b>1.5132</b>	<b>9.9100e-003</b>	<b>0.5349</b>	<b>0.0161</b>	<b>0.5510</b>	<b>0.1465</b>	<b>0.0154</b>	<b>0.1619</b>	<b>0.0000</b>	<b>943.6708</b>	<b>943.6708</b>	<b>0.0106</b>	<b>0.1144</b>	<b>978.0372</b>

**Mitigated Construction On-Site**

Category	tons/yr										MT/yr					
	ROG	NOx	CO	SO2	Fugitive PM10	Exhaust PM10	PM10 Total	Fugitive PM2.5	Exhaust PM2.5	PM2.5 Total	Bio- CO2	NBio- CO2	Total CO2	CH4	N2O	CO2e
Off-Road	0.0781	1.6290	2.0166	3.0200e-003		0.0146	0.0146		0.0146	0.0146	0.0000	261.3717	261.3717	0.0805	0.0000	263.3840
<b>Total</b>	<b>0.0781</b>	<b>1.6290</b>	<b>2.0166</b>	<b>3.0200e-003</b>		<b>0.0146</b>	<b>0.0146</b>		<b>0.0146</b>	<b>0.0146</b>	<b>0.0000</b>	<b>261.3717</b>	<b>261.3717</b>	<b>0.0805</b>	<b>0.0000</b>	<b>263.3840</b>

Green Valley Logistics (Imperial County) - Mitigated - Imperial County, Annual

**EMFAC Off-Model Adjustment Factors for Gasoline Light Duty Vehicle to Account for the SAFE Vehicle Rule Applied**

**3.4 Building Construction - 2024**

**Mitigated Construction Off-Site**

Category	tons/yr										MT/yr					
	ROG	NOx	CO	SO2	Fugitive PM10	Exhaust PM10	PM10 Total	Fugitive PM2.5	Exhaust PM2.5	PM2.5 Total	Bio- CO2	NBio- CO2	Total CO2	CH4	N2O	CO2e
Hauling	0.0148	0.6623	0.1863	3.4000e-003	0.1114	7.7800e-003	0.1192	0.0306	7.4400e-003	0.0380	0.0000	326.3922	9.1000e-004	0.0513		341.7047
Vendor	0.0374	0.7732	0.3561	4.2700e-003	0.1554	6.9800e-003	0.1624	0.0448	6.6800e-003	0.0515	0.0000	407.4348	1.7900e-003	0.0561		424.1925
Worker	0.1551	0.0800	0.9707	2.2400e-003	0.2681	1.3400e-003	0.2694	0.0712	1.2300e-003	0.0724	0.0000	209.8438	7.8500e-003	7.0500e-003		212.1400
<b>Total</b>	<b>0.2073</b>	<b>1.5155</b>	<b>1.5132</b>	<b>9.9100e-003</b>	<b>0.5349</b>	<b>0.0161</b>	<b>0.5510</b>	<b>0.1465</b>	<b>0.0154</b>	<b>0.1619</b>	<b>0.0000</b>	<b>943.6708</b>	<b>0.0106</b>	<b>0.1144</b>		<b>978.0372</b>

**3.4 Building Construction - 2025**

**Unmitigated Construction On-Site**

Category	tons/yr										MT/yr					
	ROG	NOx	CO	SO2	Fugitive PM10	Exhaust PM10	PM10 Total	Fugitive PM2.5	Exhaust PM2.5	PM2.5 Total	Bio- CO2	NBio- CO2	Total CO2	CH4	N2O	CO2e
Off-Road	0.0888	0.9030	1.1156	2.0100e-003		0.0328	0.0328		0.0304	0.0304	0.0000	173.8431	0.0535	0.0000		175.1794
<b>Total</b>	<b>0.0888</b>	<b>0.9030</b>	<b>1.1156</b>	<b>2.0100e-003</b>		<b>0.0328</b>	<b>0.0328</b>		<b>0.0304</b>	<b>0.0304</b>	<b>0.0000</b>	<b>173.8431</b>	<b>0.0535</b>	<b>0.0000</b>		<b>175.1794</b>

EFC ORIGINAL PKG

Green Valley Logistics (Imperial County) - Mitigated - Imperial County, Annual

**EMFAC Off-Model Adjustment Factors for Gasoline Light Duty Vehicle to Account for the SAFE Vehicle Rule Applied**

**3.4 Building Construction - 2025  
Unmitigated Construction Off-Site**

Category	tons/yr										MT/yr					
	ROG	NOx	CO	SO2	Fugitive PM10	Exhaust PM10	PM10 Total	Fugitive PM2.5	Exhaust PM2.5	PM2.5 Total	Bio- CO2	NBio- CO2	Total CO2	CH4	N2O	CO2e
Hauling	9.8400e-003	0.4346	0.1241	2.2100e-003	0.0741	5.1400e-003	0.0792	0.0203	4.9200e-003	0.0253	0.0000	212.0364	212.0364	6.3000e-004	0.0333	221.9848
Vendor	0.0242	0.5069	0.2301	2.7900e-003	0.1033	4.6200e-003	0.1079	0.0298	4.4200e-003	0.0342	0.0000	266.2257	266.2257	1.1700e-003	0.0364	277.1063
Worker	0.0959	0.0476	0.5975	1.4400e-003	0.1783	8.4000e-004	0.1791	0.0473	7.7000e-004	0.0481	0.0000	136.1131	136.1131	4.7200e-003	4.3600e-003	137.5292
<b>Total</b>	<b>0.1300</b>	<b>0.9891</b>	<b>0.9517</b>	<b>6.4400e-003</b>	<b>0.3557</b>	<b>0.0106</b>	<b>0.3663</b>	<b>0.0974</b>	<b>0.0101</b>	<b>0.1075</b>	<b>0.0000</b>	<b>614.3752</b>	<b>614.3752</b>	<b>6.5200e-003</b>	<b>0.0741</b>	<b>636.6203</b>

**Mitigated Construction On-Site**

Category	tons/yr										MT/yr					
	ROG	NOx	CO	SO2	Fugitive PM10	Exhaust PM10	PM10 Total	Fugitive PM2.5	Exhaust PM2.5	PM2.5 Total	Bio- CO2	NBio- CO2	Total CO2	CH4	N2O	CO2e
Off-Road	0.0520	1.0832	1.3410	2.0100e-003	9.7400e-003	9.7400e-003	9.7400e-003	9.7400e-003	9.7400e-003	9.7400e-003	0.0000	173.8429	173.8429	0.0535	0.0000	175.1792
<b>Total</b>	<b>0.0520</b>	<b>1.0832</b>	<b>1.3410</b>	<b>2.0100e-003</b>	<b>9.7400e-003</b>	<b>9.7400e-003</b>	<b>9.7400e-003</b>	<b>9.7400e-003</b>	<b>9.7400e-003</b>	<b>9.7400e-003</b>	<b>0.0000</b>	<b>173.8429</b>	<b>173.8429</b>	<b>0.0535</b>	<b>0.0000</b>	<b>175.1792</b>

EEC ORIGINAL PKG



Green Valley Logistics (Imperial County) - Mitigated - Imperial County, Annual

**EMFAC Off-Model Adjustment Factors for Gasoline Light Duty Vehicle to Account for the SAFE Vehicle Rule Applied**

**3.4 Building Construction - 2025**

**Mitigated Construction Off-Site**

Category	tons/yr										MT/yr					
	ROG	NOx	CO	SO2	Fugitive PM10	Exhaust PM10	PM10 Total	Fugitive PM2.5	Exhaust PM2.5	PM2.5 Total	Bio- CO2	NBio- CO2	Total CO2	CH4	N2O	CO2e
Hauling	9.8400e-003	0.4346	0.1241	2.2100e-003	0.0741	5.1400e-003	0.0792	0.0203	4.9200e-003	0.0253	0.0000	212.0364	212.0364	6.3000e-004	0.0333	221.9848
Vendor	0.0242	0.5069	0.2301	2.7900e-003	0.1033	4.6200e-003	0.1079	0.0298	4.4200e-003	0.0342	0.0000	266.2257	266.2257	1.1700e-003	0.0364	277.1063
Worker	0.0959	0.0476	0.5975	1.4400e-003	0.1783	8.4000e-004	0.1791	0.0473	7.7000e-004	0.0481	0.0000	136.1131	136.1131	4.7200e-003	4.3600e-003	137.5292
<b>Total</b>	<b>0.1300</b>	<b>0.9891</b>	<b>0.9517</b>	<b>6.4400e-003</b>	<b>0.3557</b>	<b>0.0106</b>	<b>0.3663</b>	<b>0.0974</b>	<b>0.0101</b>	<b>0.1075</b>	<b>0.0000</b>	<b>614.3752</b>	<b>614.3752</b>	<b>6.5200e-003</b>	<b>0.0741</b>	<b>636.6203</b>

**3.5 Paving - 2024**

**Unmitigated Construction On-Site**

Category	tons/yr										MT/yr					
	ROG	NOx	CO	SO2	Fugitive PM10	Exhaust PM10	PM10 Total	Fugitive PM2.5	Exhaust PM2.5	PM2.5 Total	Bio- CO2	NBio- CO2	Total CO2	CH4	N2O	CO2e
Off-Road	0.0124	0.1191	0.1828	2.9000e-004		5.8600e-003	5.8600e-003		5.3900e-003	5.3900e-003	0.0000	25.0332	25.0332	8.1000e-003	0.0000	25.2356
Paving	5.2400e-003					0.0000	0.0000		0.0000	0.0000	0.0000	0.0000	0.0000	0.0000	0.0000	0.0000
<b>Total</b>	<b>0.0176</b>	<b>0.1191</b>	<b>0.1828</b>	<b>2.9000e-004</b>		<b>5.8600e-003</b>	<b>5.8600e-003</b>		<b>5.3900e-003</b>	<b>5.3900e-003</b>	<b>0.0000</b>	<b>25.0332</b>	<b>25.0332</b>	<b>8.1000e-003</b>	<b>0.0000</b>	<b>25.2356</b>

EEC ORIGINAL PKG

Green Valley Logistics (Imperial County) - Mitigated - Imperial County, Annual

**EMFAC Off-Model Adjustment Factors for Gasoline Light Duty Vehicle to Account for the SAFE Vehicle Rule Applied**

**3.5 Paving - 2024**

**Unmitigated Construction Off-Site**

Category	tons/yr										MT/yr					
	ROG	NOx	CO	SO2	Fugitive PM10	Exhaust PM10	PM10 Total	Fugitive PM2.5	Exhaust PM2.5	PM2.5 Total	Bio- CO2	NBio- CO2	Total CO2	CH4	N2O	CO2e
Hauling	0.0000	0.0000	0.0000	0.0000	0.0000	0.0000	0.0000	0.0000	0.0000	0.0000	0.0000	0.0000	0.0000	0.0000	0.0000	0.0000
Vendor	0.0000	0.0000	0.0000	0.0000	0.0000	0.0000	0.0000	0.0000	0.0000	0.0000	0.0000	0.0000	0.0000	0.0000	0.0000	0.0000
Worker	6.0000e-004	3.1000e-004	3.7500e-003	1.0000e-005	1.0300e-003	1.0000e-005	1.0400e-003	2.7000e-004	0.0000	2.8000e-004	0.0000	0.8096	0.8096	3.0000e-005	3.0000e-005	0.8185
<b>Total</b>	<b>6.0000e-004</b>	<b>3.1000e-004</b>	<b>3.7500e-003</b>	<b>1.0000e-005</b>	<b>1.0300e-003</b>	<b>1.0000e-005</b>	<b>1.0400e-003</b>	<b>2.7000e-004</b>	<b>0.0000</b>	<b>2.8000e-004</b>	<b>0.0000</b>	<b>0.8096</b>	<b>0.8096</b>	<b>3.0000e-005</b>	<b>3.0000e-005</b>	<b>0.8185</b>

**Mitigated Construction On-Site**

Category	tons/yr										MT/yr					
	ROG	NOx	CO	SO2	Fugitive PM10	Exhaust PM10	PM10 Total	Fugitive PM2.5	Exhaust PM2.5	PM2.5 Total	Bio- CO2	NBio- CO2	Total CO2	CH4	N2O	CO2e
Off-Road	7.0100e-003	0.1412	0.2162	2.9000e-004	1.1400e-003	1.1400e-003	1.1400e-003	1.1400e-003	1.1400e-003	1.1400e-003	0.0000	25.0331	25.0331	8.1000e-003	0.0000	25.2355
Paving	5.2400e-003					0.0000	0.0000	0.0000	0.0000	0.0000	0.0000	0.0000	0.0000	0.0000	0.0000	0.0000
<b>Total</b>	<b>0.0123</b>	<b>0.1412</b>	<b>0.2162</b>	<b>2.9000e-004</b>	<b>1.1400e-003</b>	<b>1.1400e-003</b>	<b>1.1400e-003</b>	<b>1.1400e-003</b>	<b>1.1400e-003</b>	<b>1.1400e-003</b>	<b>0.0000</b>	<b>25.0331</b>	<b>25.0331</b>	<b>8.1000e-003</b>	<b>0.0000</b>	<b>25.2355</b>

EEC ORIGINAL PKG

Green Valley Logistics (Imperial County) - Mitigated - Imperial County, Annual

**EMFAC Off-Model Adjustment Factors for Gasoline Light Duty Vehicle to Account for the SAFE Vehicle Rule Applied**

**3.5 Paving - 2024**

**Mitigated Construction Off-Site**

Category	tons/yr										MT/yr					
	ROG	NOx	CO	SO2	Fugitive PM10	Exhaust PM10	PM10 Total	Fugitive PM2.5	Exhaust PM2.5	PM2.5 Total	Bio- CO2	NBio- CO2	Total CO2	CH4	N2O	CO2e
Hauling	0.0000	0.0000	0.0000	0.0000	0.0000	0.0000	0.0000	0.0000	0.0000	0.0000	0.0000	0.0000	0.0000	0.0000	0.0000	0.0000
Vendor	0.0000	0.0000	0.0000	0.0000	0.0000	0.0000	0.0000	0.0000	0.0000	0.0000	0.0000	0.0000	0.0000	0.0000	0.0000	0.0000
Worker	6.0000e-004	3.1000e-004	3.7500e-003	1.0000e-005	1.0300e-003	1.0000e-005	1.0400e-003	2.7000e-004	0.0000	2.8000e-004	0.0000	0.8096	0.8096	3.0000e-005	3.0000e-005	0.8185
<b>Total</b>	<b>6.0000e-004</b>	<b>3.1000e-004</b>	<b>3.7500e-003</b>	<b>1.0000e-005</b>	<b>1.0300e-003</b>	<b>1.0000e-005</b>	<b>1.0400e-003</b>	<b>2.7000e-004</b>	<b>0.0000</b>	<b>2.8000e-004</b>	<b>0.0000</b>	<b>0.8096</b>	<b>0.8096</b>	<b>3.0000e-005</b>	<b>3.0000e-005</b>	<b>0.8185</b>

**3.6 Architectural Coating - 2024**

**Unmitigated Construction On-Site**

EEC ORIGINAL PKG

Category	tons/yr										MT/yr					
	ROG	NOx	CO	SO2	Fugitive PM10	Exhaust PM10	PM10 Total	Fugitive PM2.5	Exhaust PM2.5	PM2.5 Total	Bio- CO2	NBio- CO2	Total CO2	CH4	N2O	CO2e
Archit. Coating	4.3091					0.0000	0.0000	0.0000	0.0000	0.0000	0.0000	0.0000	0.0000	0.0000	0.0000	0.0000
Off-Road	0.0119	0.0804	0.1195	2.0000e-004	4.0200e-003	4.0200e-003	4.0200e-003	4.0200e-003	4.0200e-003	4.0200e-003	0.0000	16.8515	16.8515	9.5000e-004	0.0000	16.8752
<b>Total</b>	<b>4.3210</b>	<b>0.0804</b>	<b>0.1195</b>	<b>2.0000e-004</b>	<b>4.0200e-003</b>	<b>4.0200e-003</b>	<b>4.0200e-003</b>	<b>4.0200e-003</b>	<b>4.0200e-003</b>	<b>4.0200e-003</b>	<b>0.0000</b>	<b>16.8515</b>	<b>16.8515</b>	<b>9.5000e-004</b>	<b>0.0000</b>	<b>16.8752</b>

Green Valley Logistics (Imperial County) - Mitigated - Imperial County, Annual

**EMFAC Off-Model Adjustment Factors for Gasoline Light Duty Vehicle to Account for the SAFE Vehicle Rule Applied**

**3.6 Architectural Coating - 2024**  
**Unmitigated Construction Off-Site**

Category	tons/yr										MT/yr					
	ROG	NOx	CO	SO2	Fugitive PM10	Exhaust PM10	PM10 Total	Fugitive PM2.5	Exhaust PM2.5	PM2.5 Total	Bio- CO2	NBio- CO2	Total CO2	CH4	N2O	CO2e
Hauling	0.0000	0.0000	0.0000	0.0000	0.0000	0.0000	0.0000	0.0000	0.0000	0.0000	0.0000	0.0000	0.0000	0.0000	0.0000	0.0000
Vendor	0.0000	0.0000	0.0000	0.0000	0.0000	0.0000	0.0000	0.0000	0.0000	0.0000	0.0000	0.0000	0.0000	0.0000	0.0000	0.0000
Worker	0.0211	0.0109	0.1318	3.0000e-004	0.0364	1.8000e-004	0.0366	9.6600e-003	1.7000e-004	9.8300e-003	0.0000	28.4991	28.4991	1.0700e-003	9.6000e-004	28.8109
<b>Total</b>	<b>0.0211</b>	<b>0.0109</b>	<b>0.1318</b>	<b>3.0000e-004</b>	<b>0.0364</b>	<b>1.8000e-004</b>	<b>0.0366</b>	<b>9.6600e-003</b>	<b>1.7000e-004</b>	<b>9.8300e-003</b>	<b>0.0000</b>	<b>28.4991</b>	<b>28.4991</b>	<b>1.0700e-003</b>	<b>9.6000e-004</b>	<b>28.8109</b>

**Mitigated Construction On-Site**

Category	tons/yr										MT/yr					
	ROG	NOx	CO	SO2	Fugitive PM10	Exhaust PM10	PM10 Total	Fugitive PM2.5	Exhaust PM2.5	PM2.5 Total	Bio- CO2	NBio- CO2	Total CO2	CH4	N2O	CO2e
Archit. Coating	4.3091					0.0000	0.0000		0.0000	0.0000	0.0000	0.0000	0.0000	0.0000	0.0000	0.0000
Off-Road	3.9200e-003	0.0896	0.1209	2.0000e-004		9.4000e-004	9.4000e-004	9.4000e-004	9.4000e-004	9.4000e-004	0.0000	16.8515	16.8515	9.5000e-004	0.0000	16.8752
<b>Total</b>	<b>4.3130</b>	<b>0.0896</b>	<b>0.1209</b>	<b>2.0000e-004</b>		<b>9.4000e-004</b>	<b>9.4000e-004</b>	<b>9.4000e-004</b>	<b>9.4000e-004</b>	<b>9.4000e-004</b>	<b>0.0000</b>	<b>16.8515</b>	<b>16.8515</b>	<b>9.5000e-004</b>	<b>0.0000</b>	<b>16.8752</b>

EFC ORIGINAL PKG



Green Valley Logistics (Imperial County) - Mitigated - Imperial County, Annual

**EMFAC Off-Model Adjustment Factors for Gasoline Light Duty Vehicle to Account for the SAFE Vehicle Rule Applied**

**3.6 Architectural Coating - 2024**

**Mitigated Construction Off-Site**

Category	tons/yr										MT/yr					
	ROG	NOx	CO	SO2	Fugitive PM10	Exhaust PM10	PM10 Total	Fugitive PM2.5	Exhaust PM2.5	PM2.5 Total	Bio- CO2	NBio- CO2	Total CO2	CH4	N2O	CO2e
Hauling	0.0000	0.0000	0.0000	0.0000	0.0000	0.0000	0.0000	0.0000	0.0000	0.0000	0.0000	0.0000	0.0000	0.0000	0.0000	0.0000
Vendor	0.0000	0.0000	0.0000	0.0000	0.0000	0.0000	0.0000	0.0000	0.0000	0.0000	0.0000	0.0000	0.0000	0.0000	0.0000	0.0000
Worker	0.0211	0.0109	0.1318	3.0000e-004	0.0364	1.8000e-004	0.0366	9.6600e-003	1.7000e-004	9.8300e-003	0.0000	28.4991	28.4991	1.0700e-003	9.6000e-004	28.8109
<b>Total</b>	<b>0.0211</b>	<b>0.0109</b>	<b>0.1318</b>	<b>3.0000e-004</b>	<b>0.0364</b>	<b>1.8000e-004</b>	<b>0.0366</b>	<b>9.6600e-003</b>	<b>1.7000e-004</b>	<b>9.8300e-003</b>	<b>0.0000</b>	<b>28.4991</b>	<b>28.4991</b>	<b>1.0700e-003</b>	<b>9.6000e-004</b>	<b>28.8109</b>

**3.6 Architectural Coating - 2025**

**Unmitigated Construction On-Site**

Category	tons/yr										MT/yr					
	ROG	NOx	CO	SO2	Fugitive PM10	Exhaust PM10	PM10 Total	Fugitive PM2.5	Exhaust PM2.5	PM2.5 Total	Bio- CO2	NBio- CO2	Total CO2	CH4	N2O	CO2e
Archit. Coating	3.0359					0.0000	0.0000	0.0000	0.0000	0.0000	0.0000	0.0000	0.0000	0.0000	0.0000	0.0000
Off-Road	7.9400e-003	0.0533	0.0841	1.4000e-004	2.4000e-003	2.4000e-003	2.4000e-003	2.4000e-003	2.4000e-003	2.4000e-003	0.0000	11.8726	11.8726	6.5000e-004	0.0000	11.8888
<b>Total</b>	<b>3.0439</b>	<b>0.0533</b>	<b>0.0841</b>	<b>1.4000e-004</b>	<b>2.4000e-003</b>	<b>2.4000e-003</b>	<b>2.4000e-003</b>	<b>2.4000e-003</b>	<b>2.4000e-003</b>	<b>2.4000e-003</b>	<b>0.0000</b>	<b>11.8726</b>	<b>11.8726</b>	<b>6.5000e-004</b>	<b>0.0000</b>	<b>11.8888</b>

EFC ORIGINAL PKG

Green Valley Logistics (Imperial County) - Mitigated - Imperial County, Annual

**EMFAC Off-Model Adjustment Factors for Gasoline Light Duty Vehicle to Account for the SAFE Vehicle Rule Applied**

**3.6 Architectural Coating - 2025  
Unmitigated Construction Off-Site**

Category	tons/yr										MT/yr					
	ROG	NOx	CO	SO2	Fugitive PM10	Exhaust PM10	PM10 Total	Fugitive PM2.5	Exhaust PM2.5	PM2.5 Total	Bio- CO2	NBio- CO2	Total CO2	CH4	N2O	CO2e
Hauling	0.0000	0.0000	0.0000	0.0000	0.0000	0.0000	0.0000	0.0000	0.0000	0.0000	0.0000	0.0000	0.0000	0.0000	0.0000	0.0000
Vendor	0.0000	0.0000	0.0000	0.0000	0.0000	0.0000	0.0000	0.0000	0.0000	0.0000	0.0000	0.0000	0.0000	0.0000	0.0000	0.0000
Worker	0.0138	6.8400e-003	0.0860	2.1000e-004	0.0257	1.2000e-004	0.0258	6.8100e-003	1.1000e-004	6.9200e-003	0.0000	19.5864	19.5864	6.8000e-004	6.3000e-004	19.7902
<b>Total</b>	<b>0.0138</b>	<b>6.8400e-003</b>	<b>0.0860</b>	<b>2.1000e-004</b>	<b>0.0257</b>	<b>1.2000e-004</b>	<b>0.0258</b>	<b>6.8100e-003</b>	<b>1.1000e-004</b>	<b>6.9200e-003</b>	<b>0.0000</b>	<b>19.5864</b>	<b>19.5864</b>	<b>6.8000e-004</b>	<b>6.3000e-004</b>	<b>19.7902</b>

**Mitigated Construction On-Site**

Category	tons/yr										MT/yr					
	ROG	NOx	CO	SO2	Fugitive PM10	Exhaust PM10	PM10 Total	Fugitive PM2.5	Exhaust PM2.5	PM2.5 Total	Bio- CO2	NBio- CO2	Total CO2	CH4	N2O	CO2e
Archit. Coating	3.0359					0.0000	0.0000		0.0000	0.0000	0.0000	0.0000	0.0000	0.0000	0.0000	0.0000
Off-Road	2.7600e-003	0.0631	0.0852	1.4000e-004		6.6000e-004	6.6000e-004		6.6000e-004	6.6000e-004	0.0000	11.8726	11.8726	6.5000e-004	0.0000	11.8888
<b>Total</b>	<b>3.0387</b>	<b>0.0631</b>	<b>0.0852</b>	<b>1.4000e-004</b>		<b>6.6000e-004</b>	<b>6.6000e-004</b>		<b>6.6000e-004</b>	<b>6.6000e-004</b>	<b>0.0000</b>	<b>11.8726</b>	<b>11.8726</b>	<b>6.5000e-004</b>	<b>0.0000</b>	<b>11.8888</b>

EFC ORIGINAL PKG

Green Valley Logistics (Imperial County) - Mitigated - Imperial County, Annual

**EMFAC Off-Model Adjustment Factors for Gasoline Light Duty Vehicle to Account for the SAFE Vehicle Rule Applied**

**3.6 Architectural Coating - 2025  
Mitigated Construction Off-Site**

Category	tons/yr										MT/yr					
	ROG	NOx	CO	SO2	Fugitive PM10	Exhaust PM10	PM10 Total	Fugitive PM2.5	Exhaust PM2.5	PM2.5 Total	Bio- CO2	NEIb- CO2	Total CO2	CH4	N2O	CO2e
Hauling	0.0000	0.0000	0.0000	0.0000	0.0000	0.0000	0.0000	0.0000	0.0000	0.0000	0.0000	0.0000	0.0000	0.0000	0.0000	0.0000
Vendor	0.0000	0.0000	0.0000	0.0000	0.0000	0.0000	0.0000	0.0000	0.0000	0.0000	0.0000	0.0000	0.0000	0.0000	0.0000	0.0000
Worker	0.0138	6.8400e-003	0.0860	2.1000e-004	0.0257	1.2000e-004	0.0258	6.8100e-003	1.1000e-004	6.9200e-003	0.0000	19.5864	19.5864	6.8000e-004	6.3000e-004	19.7902
<b>Total</b>	<b>0.0138</b>	<b>6.8400e-003</b>	<b>0.0860</b>	<b>2.1000e-004</b>	<b>0.0257</b>	<b>1.2000e-004</b>	<b>0.0258</b>	<b>6.8100e-003</b>	<b>1.1000e-004</b>	<b>6.9200e-003</b>	<b>0.0000</b>	<b>19.5864</b>	<b>19.5864</b>	<b>6.8000e-004</b>	<b>6.3000e-004</b>	<b>19.7902</b>

**4.0 Operational Detail - Mobile**

**4.1 Mitigation Measures Mobile**

Green Valley Logistics (Imperial County) - Mitigated - Imperial County, Annual

**EMFAC Off-Model Adjustment Factors for Gasoline Light Duty Vehicle to Account for the SAFE Vehicle Rule Applied**

Category	tons/yr											MT/yr				
	ROG	NOx	CO	SO2	Fugitive PM10	Exhaust PM10	PM10 Total	Fugitive PM2.5	Exhaust PM2.5	PM2.5 Total	Bio- CO2	NBio- CO2	Total CO2	CH4	N2O	CO2e
Mitigated	4.6100e-003	2.9700e-003	0.0481	1.4000e-004	1.9135	8.0000e-005	1.9135	0.1935	7.0000e-005	0.1936	0.0000	13.0005	13.0005	3.9000e-004	3.8000e-004	13.1219
Unmitigated	4.6100e-003	2.9700e-003	0.0481	1.4000e-004	1.9135	8.0000e-005	1.9135	0.1935	7.0000e-005	0.1936	0.0000	13.0005	13.0005	3.9000e-004	3.8000e-004	13.1219

**4.2 Trip Summary Information**

Land Use	Average Daily Trip Rate			Unmitigated Annual VMT		Mitigated Annual VMT	
	Weekday	Saturday	Sunday	Annual VMT	Annual VMT	Annual VMT	Annual VMT
Convenience Market with Gas Pumps	0.00	0.00	0.00				
General Heavy Industry	21.50	21.50	21.50	50,947	50,947	50,947	50,947
Parking Lot	0.00	0.00	0.00				
Unrefrigerated Warehouse-Rail	0.00	0.00	0.00				
<b>Total</b>	<b>21.50</b>	<b>21.50</b>	<b>21.50</b>	<b>50,947</b>	<b>50,947</b>	<b>50,947</b>	<b>50,947</b>

**4.3 Trip Type Information**

Land Use	Miles						Trip %			Trip Purpose %		
	H-W or C-W	H-S or C-C	H-O or C-NW	H-W or C-W	H-S or C-C	H-O or C-NW	H-S or C-C	H-W or C-W	Primary	Diverted	Pass-by	
Convenience Market with Gas	6.70	5.00	8.90	0.80	80.20	19.00			0	0	0	
General Heavy Industry	6.70	5.00	8.90	59.00	28.00	13.00			100	0	0	
Parking Lot	6.70	5.00	8.90	0.00	0.00	0.00			0	0	0	
Unrefrigerated Warehouse-Rail	6.70	5.00	8.90	59.00	0.00	41.00			0	0	0	

**4.4 Fleet Mix**



Green Valley Logistics (Imperial County) - Mitigated - Imperial County, Annual

**EMFAC Off-Model Adjustment Factors for Gasoline Light Duty Vehicle to Account for the SAFE Vehicle Rule Applied**

Land Use	LDA	LDT1	LDT2	MDV	LHD1	LHD2	MHD	HHD	OBUS	UBUS	MCY	SBUS	MH
Convenience Market with Gas Pumps	0.530702	0.059328	0.179664	0.144474	0.026250	0.006790	0.008325	0.016302	0.000941	0.000118	0.022966	0.000752	0.003388
General Heavy Industry	1.000000	0.000000	0.000000	0.000000	0.000000	0.000000	0.000000	0.000000	0.000000	0.000000	0.000000	0.000000	0.000000
Parking Lot	0.530702	0.059328	0.179664	0.144474	0.026250	0.006790	0.008325	0.016302	0.000941	0.000118	0.022966	0.000752	0.003388
Unrefrigerated Warehouse-Rail	0.530702	0.059328	0.179664	0.144474	0.026250	0.006790	0.008325	0.016302	0.000941	0.000118	0.022966	0.000752	0.003388

**5.0 Energy Detail**

Historical Energy Use: N

**5.1 Mitigation Measures Energy**

Category	tons/yr										MT/yr						
	ROG	NOx	CO	SO2	Fugitive PM10	Exhaust PM10	PM10 Total	Fugitive PM2.5	Exhaust PM2.5	PM2.5 Total	Bio- CO2	NBio- CO2	Total CO2	CH4	N2O	CO2e	
Electricity Mitigated						0.0000	0.0000		0.0000	0.0000	0.0000	249.2501	249.2501	0.0433		5.2500e-003	251.8963
Electricity Unmitigated						0.0000	0.0000		0.0000	0.0000	0.0000	249.2501	249.2501	0.0433		5.2500e-003	251.8963
Natural Gas Mitigated	0.0196	0.1780	0.1495	1.0700e-003		0.0135	0.0135		0.0135	0.0135	0.0000	193.7890	193.7890	3.7100e-003		3.5500e-003	194.9406
Natural Gas Unmitigated	0.0196	0.1780	0.1495	1.0700e-003		0.0135	0.0135		0.0135	0.0135	0.0000	193.7890	193.7890	3.7100e-003		3.5500e-003	194.9406

ELC ORIGINAL PKG

Green Valley Logistics (Imperial County) - Mitigated - Imperial County, Annual

**EMFAC Off-Model Adjustment Factors for Gasoline Light Duty Vehicle to Account for the SAFE Vehicle Rule Applied**

**5.2 Energy by Land Use - NaturalGas**

**Unmitigated**

Land Use	NaturalGas Use kBtu/yr	tons/yr										MT/yr					
		ROG	NOx	CO	SO2	Fugitive PM10	Exhaust PM10	PM10 Total	Fugitive PM2.5	Exhaust PM2.5	PM2.5 Total	Bio- CO2	NBio- CO2	Total CO2	CH4	N2O	CO2e
Convenience Market with Gas Pumps	4969.36	3.0000e-005	2.4000e-004	2.0000e-004	0.0000	2.0000e-005	2.0000e-005	2.0000e-005	2.0000e-005	2.0000e-005	2.0000e-005	0.0000	0.2652	0.2652	1.0000e-005	0.0000	0.2688
General Heavy Industry	1.6165e+006	8.7200e-003	0.0792	0.0666	4.8000e-004	6.0200e-003	6.0200e-003	6.0200e-003	6.0200e-003	6.0200e-003	6.0200e-003	0.0000	86.2626	86.2626	1.6500e-003	1.5800e-003	86.7752
Parking Lot	0	0.0000	0.0000	0.0000	0.0000	0.0000	0.0000	0.0000	0.0000	0.0000	0.0000	0.0000	0.0000	0.0000	0.0000	0.0000	0.0000
Unrefrigerated Warehouse-Rail	2.01e+006	0.0108	0.0985	0.0828	5.9000e-004	7.4900e-003	7.4900e-003	7.4900e-003	7.4900e-003	7.4900e-003	7.4900e-003	0.0000	107.2613	107.2613	2.0600e-003	1.9700e-003	107.9887
<b>Total</b>		<b>0.0196</b>	<b>0.1780</b>	<b>0.1495</b>	<b>1.0700e-003</b>	<b>0.0135</b>	<b>0.0135</b>	<b>0.0135</b>	<b>0.0135</b>	<b>0.0135</b>	<b>0.0135</b>	<b>0.0000</b>	<b>193.7890</b>	<b>193.7890</b>	<b>3.7200e-003</b>	<b>3.5500e-003</b>	<b>194.9406</b>

Green Valley Logistics (Imperial County) - Mitigated - Imperial County, Annual

**EMFAC Off-Model Adjustment Factors for Gasoline Light Duty Vehicle to Account for the SAFE Vehicle Rule Applied**

**5.2 Energy by Land Use - NaturalGas**

**Mitigated**

Land Use	NaturalGas Use kBTU/yr	tons/yr										MT/yr					
		ROG	NOx	CO	SO2	Fugitive PM10	Exhaust PM10	PM10 Total	Fugitive PM2.5	Exhaust PM2.5	PM2.5 Total	Bio- CO2	NBio- CO2	Total CO2	CH4	N2O	CO2e
Convenience Market with Gas Pumps	4969.36	3.0000e-005	2.4000e-004	2.0000e-004	0.0000	2.0000e-005	2.0000e-005	2.0000e-005	2.0000e-005	2.0000e-005	0.0000	0.2652	0.2652	1.0000e-005	0.0000	0.0000	0.2668
General Heavy Industry	1.6165e+006	8.7200e-003	0.0792	0.0666	4.8000e-004	6.0200e-003	6.0200e-003	6.0200e-003	6.0200e-003	6.0200e-003	0.0000	86.2626	86.2626	1.6500e-003	1.5800e-003	1.5800e-003	86.7752
Parking Lot	0	0.0000	0.0000	0.0000	0.0000	0.0000	0.0000	0.0000	0.0000	0.0000	0.0000	0.0000	0.0000	0.0000	0.0000	0.0000	0.0000
Unrefrigerated Warehouse-Rail	2.01e+006	0.0108	0.0965	0.0828	5.9000e-004	7.4900e-003	7.4900e-003	7.4900e-003	7.4900e-003	7.4900e-003	0.0000	107.2613	107.2613	2.0600e-003	1.9700e-003	1.9700e-003	107.8987
<b>Total</b>		<b>0.0196</b>	<b>0.1780</b>	<b>0.1495</b>	<b>1.0700e-003</b>	<b>0.0135</b>	<b>0.0135</b>	<b>0.0135</b>	<b>0.0135</b>	<b>0.0135</b>	<b>0.0000</b>	<b>193.7890</b>	<b>193.7890</b>	<b>3.7200e-003</b>	<b>3.5500e-003</b>	<b>3.5500e-003</b>	<b>194.9406</b>

Green Valley Logistics (Imperial County) - Mitigated - Imperial County, Annual

**EMFAC Off-Model Adjustment Factors for Gasoline Light Duty Vehicle to Account for the SAFE Vehicle Rule Applied**

**5.3 Energy by Land Use - Electricity**

**Unmitigated**

Land Use	Electricity Use	Total CO2	CH4	N2O	CO2e
	kWh/yr	MT/yr			
Convenience Market with Gas Pumps	27421.8	2.3630	4.1000e-004	5.0000e-005	2.3881
General Heavy Industry	496000	42.7421	7.4200e-003	9.0000e-004	43.1956
Parking Lot	49000	4.2225	7.3000e-004	9.0000e-005	4.2673
Unrefrigerated Warehouse-Rail	2.32e+006	199.9225	0.0347	4.2100e-003	202.0450
<b>Total</b>		<b>249.2501</b>	<b>0.0433</b>	<b>5.2500e-003</b>	<b>251.8963</b>



**EMFAC Off-Model Adjustment Factors for Gasoline Light Duty Vehicle to Account for the SAFE Vehicle Rule Applied**

**5.3 Energy by Land Use - Electricity**

**Mitigated**

Land Use	Electricity Use kWh/yr	Total CO2	CH4	N2O	CO2e
MT/yr					
Convenience Market with Gas Pumps	27421.8	2.3630	4.1000e-004	5.0000e-005	2.3881
General Heavy Industry	496000	42.7421	7.4200e-003	9.0000e-004	43.1958
Parking Lot	49000	4.2225	7.3000e-004	9.0000e-005	4.2673
Unrefrigerated Warehouse-Rail	2.32e+006	199.9225	0.0347	4.2100e-003	202.0450
<b>Total</b>		<b>249.2501</b>	<b>0.0433</b>	<b>5.2500e-003</b>	<b>251.8963</b>

**6.0 Area Detail**

**6.1 Mitigation Measures Area**

Green Valley Logistics (Imperial County) - Mitigated - Imperial County, Annual

**EMFAC Off-Model Adjustment Factors for Gasoline Light Duty Vehicle to Account for the SAFE Vehicle Rule Applied**

Category	tons/yr										MT/yr					
	ROG	NOx	CO	SO2	Fugitive PM10	Exhaust PM10	PM10 Total	Fugitive PM2.5	Exhaust PM2.5	PM2.5 Total	Bio- CO2	NBio- CO2	Total CO2	CH4	N2O	CO2e
Mitigated	4.8543	1.2000e-004	0.0130	0.0000	5.0000e-005	5.0000e-005	5.0000e-005	5.0000e-005	5.0000e-005	5.0000e-005	0.0000	0.0253	0.0253	7.0000e-005	0.0000	0.0270
Unmitigated	4.8543	1.2000e-004	0.0130	0.0000	5.0000e-005	5.0000e-005	5.0000e-005	5.0000e-005	5.0000e-005	5.0000e-005	0.0000	0.0253	0.0253	7.0000e-005	0.0000	0.0270

**6.2 Area by SubCategory**

Unmitigated

SubCategory	tons/yr										MT/yr					
	ROG	NOx	CO	SO2	Fugitive PM10	Exhaust PM10	PM10 Total	Fugitive PM2.5	Exhaust PM2.5	PM2.5 Total	Bio- CO2	NBio- CO2	Total CO2	CH4	N2O	CO2e
Architectural Coating	0.7345				0.0000	0.0000	0.0000	0.0000	0.0000	0.0000	0.0000	0.0000	0.0000	0.0000	0.0000	0.0000
Consumer Products	4.1187				0.0000	0.0000	0.0000	0.0000	0.0000	0.0000	0.0000	0.0000	0.0000	0.0000	0.0000	0.0000
Landscaping	1.1900e-003	1.2000e-004	0.0130	0.0000	5.0000e-005	5.0000e-005	5.0000e-005	5.0000e-005	5.0000e-005	5.0000e-005	0.0000	0.0253	0.0253	7.0000e-005	0.0000	0.0270
<b>Total</b>	<b>4.8543</b>	<b>1.2000e-004</b>	<b>0.0130</b>	<b>0.0000</b>	<b>5.0000e-005</b>	<b>5.0000e-005</b>	<b>5.0000e-005</b>	<b>5.0000e-005</b>	<b>5.0000e-005</b>	<b>5.0000e-005</b>	<b>0.0000</b>	<b>0.0253</b>	<b>0.0253</b>	<b>7.0000e-005</b>	<b>0.0000</b>	<b>0.0270</b>

REC ORIGINAL PKG

Green Valley Logistics (Imperial County) - Mitigated - Imperial County, Annual

**EMFAC Off-Model Adjustment Factors for Gasoline Light Duty Vehicle to Account for the SAFE Vehicle Rule Applied**

**6.2 Area by SubCategory**

**Mitigated**

SubCategory	tons/yr										MT/yr					
	ROG	NOx	CO	SO2	Fugitive PM10	Exhaust PM10	PM10 Total	Fugitive PM2.5	Exhaust PM2.5	PM2.5 Total	Bio- CO2	NBio- CO2	Total CO2	CH4	N2O	CO2e
Architectural Coating	0.7345					0.0000	0.0000		0.0000	0.0000	0.0000	0.0000	0.0000	0.0000	0.0000	0.0000
Consumer Products	4.1187					0.0000	0.0000		0.0000	0.0000	0.0000	0.0000	0.0000	0.0000	0.0000	0.0000
Landscaping	1.1900e-003	1.2000e-004	0.0130	0.0000		5.0000e-005	5.0000e-005		5.0000e-005	5.0000e-005	0.0000	0.0253	0.0253	7.0000e-005	0.0000	0.0270
<b>Total</b>	<b>4.8543</b>	<b>1.2000e-004</b>	<b>0.0130</b>	<b>0.0000</b>		<b>5.0000e-005</b>	<b>5.0000e-005</b>		<b>5.0000e-005</b>	<b>5.0000e-005</b>	<b>0.0000</b>	<b>0.0253</b>	<b>0.0253</b>	<b>7.0000e-005</b>	<b>0.0000</b>	<b>0.0270</b>

**7.0 Water Detail**

**7.1 Mitigation Measures Water**

**ECC ORIGINAL PKG**

Green Valley Logistics (Imperial County) - Mitigated - Imperial County, Annual

**EMFAC Off-Model Adjustment Factors for Gasoline Light Duty Vehicle to Account for the SAFE Vehicle Rule Applied**

Category	Total CO2	CH4	N2O	CO2e
Mitigated	61.9339	0.4011	0.0105	75.0780
Unmitigated	61.9339	0.4011	0.0105	75.0780

**7.2 Water by Land Use**

**Unmitigated**

Land Use	Indoor/Outdoor Use	Total CO2	CH4	N2O	CO2e
Convenience Market with Gas Pumps	0 / 0	0.0000	0.0000	0.0000	0.0000
General Heavy Industry	0 / 0	0.0000	0.0000	0.0000	0.0000
Parking Lot	0 / 0	0.0000	0.0000	0.0000	0.0000
Refrigerated Warehouse-Rail	12 / 46.65	61.9339	0.4011	0.0105	75.0780
<b>Total</b>		<b>61.9339</b>	<b>0.4011</b>	<b>0.0105</b>	<b>75.0780</b>

ECO ORIGINAL PKG



Green Valley Logistics (Imperial County) - Mitigated - Imperial County, Annual

**EMFAC Off-Model Adjustment Factors for Gasoline Light Duty Vehicle to Account for the SAFE Vehicle Rule Applied**

**7.2 Water by Land Use**

**Mitigated**

Land Use	Indoor/Outdoor Use	Total CO2	CH4	N2O	CO2e
	Mgal	MT/yr			
Convenience Market with Gas Pumps	0 / 0	0.0000	0.0000	0.0000	0.0000
General Heavy Industry	0 / 0	0.0000	0.0000	0.0000	0.0000
Parking Lot	0 / 0	0.0000	0.0000	0.0000	0.0000
Unrefrigerated Warehouse-Rail	12 / 46.65	61.9339	0.4011	0.0105	75.0780
<b>Total</b>		<b>61.9339</b>	<b>0.4011</b>	<b>0.0105</b>	<b>75.0780</b>

**8.0 Waste Detail**

**8.1 Mitigation Measures Waste**

EEC ORIGINAL PKG

Green Valley Logistics (Imperial County) - Mitigated - Imperial County, Annual

**EMFAC Off-Model Adjustment Factors for Gasoline Light Duty Vehicle to Account for the SAFE Vehicle Rule Applied**

**Category/Year**

	Total CO2	CH4	N2O	CO2e
	MT/yr			
Mitigated	50.7477	2.9991	0.0000	125.7254
Unmitigated	50.7477	2.9991	0.0000	125.7254

**8.2 Waste by Land Use**

**Unmitigated**

Land Use	Waste Disposed (tons)	Total CO2	CH4	N2O	CO2e
General Heavy Industry	62	12.5854	0.7438	0.0000	31.1799
Parking Lot	0	0.0000	0.0000	0.0000	0.0000
Unrefrigerated Warehouse-Rail	188	38.1823	2.2553	0.0000	94.5455
<b>Total</b>		<b>50.7477</b>	<b>2.9991</b>	<b>0.0000</b>	<b>125.7254</b>

TEC ORIGINAL PKG

**EMFAC Off-Model Adjustment Factors for Gasoline Light Duty Vehicle to Account for the SAFE Vehicle Rule Applied**

**8.2 Waste by Land Use**

**Mitigated**

Land Use	Waste Disposed tons	Total CO2 MT/yr	CH4	N2O	CO2e
General Heavy Industry	62	12.5854	0.7438	0.0000	31.1799
Parking Lot	0	0.0000	0.0000	0.0000	0.0000
Unrefrigerated Warehouse-Rail	188	38.1623	2.2553	0.0000	94.5455
<b>Total</b>		<b>50.7477</b>	<b>2.9991</b>	<b>0.0000</b>	<b>125.7254</b>

**9.0 Operational Offroad**

Equipment Type	Number	Hours/Day	Days/Year	Horse Power	Load Factor	Fuel Type
----------------	--------	-----------	-----------	-------------	-------------	-----------

**10.0 Stationary Equipment**

**Fire Pumps and Emergency Generators**

Equipment Type	Number	Hours/Day	Hours/Year	Horse Power	Load Factor	Fuel Type
----------------	--------	-----------	------------	-------------	-------------	-----------

**Boilers**

Equipment Type	Number	Heat Input/Day	Heat Input/Year	Boiler Rating	Fuel Type
----------------	--------	----------------	-----------------	---------------	-----------

**User Defined Equipment**

Equipment Type	Number
----------------	--------

REC ORIGINAL PKG

Green Valley Logistics (Imperial County) - Mitigated - Imperial County, Annual

**EMFAC Off-Model Adjustment Factors for Gasoline Light Duty Vehicle to Account for the SAFE Vehicle Rule Applied**

**11.0 Vegetation**

---



**ATTACHMENT C**

AERMOD for Onsite Construction PM<sub>10</sub> - DPM

EEC ORIGINAL PKG

1 AERMOD PRIME - (DATED 19191)  
AERMODPrMSPx VERSION  
(C) COPYRIGHT 1998-2017, Trinity Consultants

Run Began on 7/18/2023 at 13:33:33

\*\* BREEZE AERMOD  
\*\* Trinity Consultants  
\*\* VERSION 10.0

CO STARTING  
CO TITLEONE Construction PM10  
CO MODELOPT DFAULT CONC NODRYDPLT NOWETDPLT  
CO RUNORNOT RUN  
CO AVERTIME ANNUAL  
CO POLLUTID PM10  
CO FINISHED

SO STARTING  
SO ELEVUNIT METERS  
SO LOCATION GXDJ4001 AREAPOLY 635031.3 3640926.8 0  
\*\* SRCDESCR Area Source  
SO SRCPARAM GXDJ4001 5.76E-10 3 10 1  
SO AREAVERT GXDJ4001 635031.3 3640926.8 634990.5 3640794.1 634968.6 3640748.8 634948.2 3640725.5  
SO AREAVERT GXDJ4001 634679.7 3639699.6 633773.5 3639702.5 633776.4 3640518.3 634164.6 3640518.3  
SO AREAVERT GXDJ4001 634166 3640922.5 635031.3 3640926.8  
SO SRCGROUP ALL  
SO FINISHED

RE STARTING  
RE ELEVUNIT METERS  
RE DISCCART 635155.4 3639817.8 0 0  
\*\* SENSITIV  
\*\* RCPDESCR R1  
RE DISCCART 633804.4 3638911 0 0  
\*\* SENSITIV  
\*\* RCPDESCR R2  
RE FINISHED

ME STARTING  
ME SURFFILE "G:\My Drive\County of Imperial\21-170 Green Valley Logistics Center\AERMOD\ATLIS AERMOD\722810.SFC"  
\*\* SURFFILE "G:\My Drive\County of Imperial\21-170 Green Valley Logistics Center\AERMOD\ATLIS AERMOD\722810.SFC"  
ME PROFFILE "G:\My Drive\County of Imperial\21-170 Green Valley Logistics Center\AERMOD\ATLIS AERMOD\722810.PFL"  
\*\* PROFFILE "G:\My Drive\County of Imperial\21-170 Green Valley Logistics Center\AERMOD\ATLIS AERMOD\722810.PFL"  
ME SURFDATA 23199 2009  
ME UAIRDATA 3190 2009  
ME PROFBASE 0 METERS  
ME FINISHED

OU STARTING  
OU FILEFORM FIX  
OU PLOTFILE ANNUAL ALL ALL`ANNUAL.plt 10000  
OU FINISHED

\*\* \*\*\*\*\*  
\*\* It is recommended that the user not edit any data below this line  
\*\* \*\*\*\*\*

\*\* AMPTYPE  
\*\* AMPDATUM -1  
\*\* AMPZONE -1  
\*\* AMPHEMISPHERE

\*\* PROJECTIONWKT  
PROJCS["UTM\_6326\_Zone11",GEOGCS["WGS\_84",DATUM["World\_Geodetic\_System\_1984",SPHEROID["WGS\_1984",6378137,298.257223563],TOWGS84[0,0,0,0,0,0,0,0,0]],PRIMEM["Greenwich",0],UNIT["Degree",0.0174532925199433]],PROJECTION["Universal\_Transverse\_Mercator"],PARAMETER["Zone",11],UNIT["Meter",1,AUTHORITY["EPSG","9001"]]]

```

** PROJECTION UTM
** DATUM WGE
** UNITS METER
** ZONE 11
** HEMISPHERE N
** ORIGINLON 0
** ORIGINLAT 0
** PARALLEL1 0
** PARALLEL2 0
** AZIMUTH 0
** SCALEFACT 0
** FALSEEAST 0
** FALSENORTH 0

** POSTFMT UNFORM
** TEMPLATE USERDEFINED
** AERMODEXE AERMOD_BREEZE_19191_64.EXE
** AERMAPEXE AERMAP_EPA_18081_64.EXE

```

```

*****
*** SETUP Finishes Successfully ***
*****

```

```

^ *** AERMOD - VERSION 19191 *** *** Construction PM10 ***
   07/18/23
*** AERMET - VERSION 14134 *** ***
   13:33:33

```

```

PAGE 1
*** MODELOPTs: RegDEFAULT CONC ELEV NODRYDPLT NOWETDPLT RURAL

```

\*\*\* MODEL SETUP OPTIONS SUMMARY \*\*\*

\*\*Model Is Setup For Calculation of Average CONCentration Values.

```

-- DEPOSITION LOGIC --
**NO GAS DEPOSITION Data Provided.
**NO PARTICLE DEPOSITION Data Provided.
**Model Uses NO DRY DEPLETION. DRYDPLT = F
**Model Uses NO WET DEPLETION. WETDPLT = F

```

\*\*Model Uses RURAL Dispersion Only.

```

**Model Uses Regulatory DEFAULT Options:
  1. Stack-tip Downwash.
  2. Model Accounts for ELEVated Terrain Effects.
  3. Use Calms Processing Routine.
  4. Use Missing Data Processing Routine.
  5. No Exponential Decay.

```

```

**Other Options Specified:
  CCVR_Sub - Meteorological data includes CCVR substitutions
  TEMP_Sub - Meteorological data includes TEMP substitutions

```

\*\*Model Assumes No FLAGPOLE Receptor Heights.

\*\*The User Specified a Pollutant Type of: PM10

\*\*Model Calculates ANNUAL Averages Only

```

**This Run Includes:      1 Source(s);      1 Source Group(s); and      2 Receptor(s)

with:    0 POINT(s), including
          0 POINTCAP(s) and      0 POINTHOR(s)
and:     0 VOLUME source(s)
and:     1 AREA type source(s)

```

and: 0 LINE source(s)  
 and: 0 RLINE/RLINEXT source(s)  
 and: 0 OPENPIT source(s)  
 and: 0 BUOYANT LINE source(s) with 0 line(s)

\*\*Model Set To Continue RUNning After the Setup Testing.

\*\*The AERMET Input Meteorological Data Version Date: 14134

\*\*Output Options Selected:  
 Model Outputs Tables of ANNUAL Averages by Receptor  
 Model Outputs External File(s) of High Values for Plotting (PLOTFILE Keyword)

\*\*NOTE: The Following Flags May Appear Following CONC Values: c for Calm Hours  
 m for Missing Hours  
 b for Both Calm and Missing Hours

\*\*Misc. Inputs: Base Elev. for Pot. Temp. Profile (m MSL) = 0.00 ; Decay Coef. = 0.000 ; Rot. Angle = 0.0  
 Emission Units = GRAMS/SEC ; Emission Rate Unit Factor = 0.10000E+07  
 Output Units = MICROGRAMS/M\*\*3

\*\*Approximate Storage Requirements of Model = 3.5 MB of RAM.

\*\*Input Runstream File: aermod.inp

\*\*Output Print File: aermod.out

▲ \*\*\* AERMOD - VERSION 19191 \*\*\* \*\*\* Construction PM10 \*\*\*  
 07/18/23  
 \*\*\* AERMET - VERSION 14134 \*\*\* \*\*\*  
 13:33:33 \*\*\*

PAGE 2

\*\*\* MODELOPTs: RegDEFAULT CONC ELEV NODRYDPLT NOWETDPLT RURAL

\*\*\* AREAPOLY SOURCE DATA \*\*\*

SOURCE ID	NUMBER PART. CATS.	EMISSION RATE (GRAMS/SEC /METER**2)	LOCATION OF AREA X (METERS)	Y (METERS)	BASE ELEV. (METERS)	RELEASE HEIGHT (METERS)	NUMBER OF VERTS.	INIT. SZ (METERS)	URBAN SOURCE	EMISSION RATE SCALAR VARY BY
-----------	--------------------	-------------------------------------	-----------------------------	------------	---------------------	-------------------------	------------------	-------------------	--------------	------------------------------

GXDJ4001	0	0.57600E-09	635031.3	3640926.8	0.0	3.00	10	1.00	NO	
----------	---	-------------	----------	-----------	-----	------	----	------	----	--

▲ \*\*\* AERMOD - VERSION 19191 \*\*\* \*\*\* Construction PM10 \*\*\*  
 07/18/23  
 \*\*\* AERMET - VERSION 14134 \*\*\* \*\*\*  
 13:33:33 \*\*\*

PAGE 3

\*\*\* MODELOPTs: RegDEFAULT CONC ELEV NODRYDPLT NOWETDPLT RURAL

\*\*\* SOURCE IDs DEFINING SOURCE GROUPS \*\*\*

SRCGROUP ID	SOURCE IDs
-------------	------------

ALL	GXDJ4001
-----	----------

▲ \*\*\* AERMOD - VERSION 19191 \*\*\* \*\*\* Construction PM10 \*\*\*  
 07/18/23  
 \*\*\* AERMET - VERSION 14134 \*\*\* \*\*\*  
 13:33:33 \*\*\*





2.0  
09 01 01 1 07 -6.8 0.078 -9.000 -9.000 -999. 52. 6.3 0.02 0.78 1.00 2.36 265. 10.0 279.2  
2.0  
09 01 01 1 08 -9.3 0.152 -9.000 -9.000 -999. 142. 34.3 0.02 0.78 0.47 2.86 223. 10.0 282.0  
2.0  
09 01 01 1 09 33.3 0.160 0.392 0.016 65. 154. -11.2 0.04 0.78 0.29 1.76 317. 10.0 285.4  
2.0  
09 01 01 1 10 75.5 -9.000 -9.000 -9.000 132. -999. -99999.0 0.06 0.78 0.23 0.00 0. 10.0 288.8  
2.0  
09 01 01 1 11 103.9 -9.000 -9.000 -9.000 208. -999. -99999.0 0.06 0.78 0.21 0.00 0. 10.0 291.4  
2.0  
09 01 01 1 12 116.7 0.201 0.961 0.010 276. 216. -6.3 0.08 0.78 0.20 1.76 26. 10.0 293.1  
2.0  
09 01 01 1 13 113.3 -9.000 -9.000 -9.000 376. -999. -99999.0 0.06 0.78 0.20 0.00 0. 10.0 293.8  
2.0  
09 01 01 1 14 94.7 -9.000 -9.000 -9.000 445. -999. -99999.0 0.06 0.78 0.21 0.00 0. 10.0 295.4  
2.0  
09 01 01 1 15 60.5 -9.000 -9.000 -9.000 482. -999. -99999.0 0.06 0.78 0.25 0.00 0. 10.0 295.4  
2.0  
09 01 01 1 16 14.2 0.120 0.581 0.007 499. 100. -10.9 0.02 0.78 0.35 1.50 284. 10.0 294.1  
2.0  
09 01 01 1 17 -999.0 -9.000 -9.000 -9.000 -999. -999. -99999.0 0.06 0.78 0.65 0.00 0. 10.0 292.1  
2.0  
09 01 01 1 18 -999.0 -9.000 -9.000 -9.000 -999. -999. -99999.0 0.06 0.78 1.00 0.00 0. 10.0 289.1  
2.0  
09 01 01 1 19 -21.3 0.190 -9.000 -9.000 -999. 200. 29.3 0.08 0.78 1.00 3.10 24. 10.0 285.1  
2.0  
09 01 01 1 20 -7.6 0.087 -9.000 -9.000 -999. 68. 8.0 0.08 0.78 1.00 2.10 17. 10.0 284.1  
2.0  
09 01 01 1 21 -999.0 -9.000 -9.000 -9.000 -999. -999. -99999.0 0.06 0.78 1.00 0.00 0. 10.0 284.1  
2.0  
09 01 01 1 22 -8.2 0.086 -9.000 -9.000 -999. 60. 6.9 0.02 0.78 1.00 2.60 252. 10.0 282.1  
2.0  
09 01 01 1 23 -8.2 0.086 -9.000 -9.000 -999. 60. 6.9 0.02 0.78 1.00 2.60 270. 10.0 281.1  
2.0  
09 01 01 1 24 -8.2 0.086 -9.000 -9.000 -999. 60. 6.9 0.02 0.78 1.00 2.60 280. 10.0 280.1  
2.0

First hour of profile data

YR MO DY HR HEIGHT F WDIR WSPD AMB\_TMP sigmaA sigmaW sigmaV  
09 01 01 01 10.0 1 251. 2.86 280.4 99.0 -99.00 -99.00

F indicates top of profile (=1) or below (=0)

\*\*\* AERMOD - VERSION 19191 \*\*\* \*\* Construction PM10 \*\*\*  
07/18/23  
\*\*\* AERMET - VERSION 14134 \*\*\* \*\*  
13:33:33

PAGE 6

\*\*\* MODELOPTs: RegDEFAULT CONC ELEV NODRYDPLT NOWETDPLT RURAL

\*\*\* THE ANNUAL AVERAGE CONCENTRATION VALUES AVERAGED OVER 5 YEARS FOR SOURCE GROUP: ALL  
INCLUDING SOURCE(S): GXDJ4001 ,

\*\*\* SENSITIVE DISCRETE RECEPTOR POINTS \*\*\*

		** CONC OF PM10	IN MICROGRAMS/M**3		**
X-COORD (M)	Y-COORD (M)	CONC	X-COORD (M)	Y-COORD (M)	CONC
635155.40	3639817.80	0.00295	633804.40	3638911.00	0.00019

\*\*\* AERMOD - VERSION 19191 \*\*\* \*\* Construction PM10 \*\*\*  
07/18/23  
\*\*\* AERMET - VERSION 14134 \*\*\* \*\*  
13:33:33

PAGE 7  
\*\*\* MODELOPTs: RegDEFAULT CONC ELEV NODRYDPLT NOWETDPLT RURAL

\*\*\* THE SUMMARY OF MAXIMUM ANNUAL RESULTS AVERAGED OVER 5 YEARS \*\*\*

\*\* CONC OF PM10 IN MICROGRAMS/M\*\*3 \*\*

NETWORK  
GROUP ID AVERAGE CONC RECEPTOR (XR, YR, ZELEV, ZHILL, ZFLAG) OF TYPE  
GRID-ID

ALL 1ST HIGHEST VALUE IS 0.00295 AT ( 635155.40, 3639817.80, 0.00, 0.00, 0.00) SR  
2ND HIGHEST VALUE IS 0.00019 AT ( 633804.40, 3638911.00, 0.00, 0.00, 0.00) SR  
3RD HIGHEST VALUE IS 0.00000 AT ( 0.00, 0.00, 0.00, 0.00, 0.00)  
4TH HIGHEST VALUE IS 0.00000 AT ( 0.00, 0.00, 0.00, 0.00, 0.00)  
5TH HIGHEST VALUE IS 0.00000 AT ( 0.00, 0.00, 0.00, 0.00, 0.00)  
6TH HIGHEST VALUE IS 0.00000 AT ( 0.00, 0.00, 0.00, 0.00, 0.00)  
7TH HIGHEST VALUE IS 0.00000 AT ( 0.00, 0.00, 0.00, 0.00, 0.00)  
8TH HIGHEST VALUE IS 0.00000 AT ( 0.00, 0.00, 0.00, 0.00, 0.00)  
9TH HIGHEST VALUE IS 0.00000 AT ( 0.00, 0.00, 0.00, 0.00, 0.00)  
10TH HIGHEST VALUE IS 0.00000 AT ( 0.00, 0.00, 0.00, 0.00, 0.00)

\*\*\* RECEPTOR TYPES: GC = GRIDCART  
GP = GRIDPOLR  
DC = DISCCART  
DP = DISCPOLR

\*\*\* AERMOD - VERSION 19191 \*\*\* \*\*\* Construction PM10  
07/18/23

\*\*\* AERMET - VERSION 14134 \*\*\* \*\*\*  
13:33:33

\*\*\*  
\*\*\*

PAGE 8  
\*\*\* MODELOPTs: RegDEFAULT CONC ELEV NODRYDPLT NOWETDPLT RURAL

\*\*\* Message Summary : AERMOD Model Execution \*\*\*

----- Summary of Total Messages -----

A Total of 0 Fatal Error Message(s)  
A Total of 1 Warning Message(s)  
A Total of 14777 Informational Message(s)  
A Total of 51336 Hours Were Processed  
A Total of 7189 Calm Hours Identified  
A Total of 7588 Missing Hours Identified ( 14.78 Percent)

CAUTION!: Number of Missing Hours Exceeds 10 Percent of Total!  
Data May Not Be Acceptable for Regulatory Applications.  
See Section 5.3.2 of "Meteorological Monitoring Guidance  
for Regulatory Modeling Applications" (EPA-454/R-99-005).

\*\*\*\*\* FATAL ERROR MESSAGES \*\*\*\*\*  
\*\*\* NONE \*\*\*

\*\*\*\*\* WARNING MESSAGES \*\*\*\*\*  
MX W481 51337 MAIN: Data Remaining After End of Year. Number of Hours= 7512

EEC ORIGINAL PKG

\*\*\*\*\*  
\*\*\* AERMOD Finishes Successfully \*\*\*  
\*\*\*\*\*

**ATTACHMENT D**

Construction Health Risk Calculations

EEC ORIGINAL PKG



**Air Quality Health Risk Calculations (Worst-Case)**  
**GreenValley Tier 3 Design Feature**

From CalEE Annual Output	Emission per day (Ton/Total Construction Duration)	0.0346				
	Construction Start	1/1/2024				
	Construction Complete	6/30/2025				
	Days	546				
	Construction Emission per day (lb/day)	0.126739927				
	Annual Duration (Days)	365				
	Annualized Emission Rate (Grams/Second)	0.000664504				
	Project Site Size (Acres)	285				
	Project Site Size (meters^2)	1153354.08				
	Length of Smalles Side (meters)	1073.943239				
Used as an input to AERMOD	Emission Rate over Grading Area( g/s-m^2)	5.76E-10				
From AERMOD	Concentration Annual (Ug/M^3)	0.00295				
	Days	546	Days to years			
Duration			1.495890411			
Age (Years)	3rd Trimester (0.25)		0-2	2-9	2-16	16-30
						16-70
Cair (annual) - From F15	0.00295	0.00295	0.00295	0.00295	0.00295	0.00295
Breathing Rate per agegroup BR/BW (Page 5-25)	361	1090	861	745	335	290
A (Default is 1)	1	1	1	1	1	1
Exposure Frequency = EF (days/365days)	0.96	0.96	0.96	0.96	0.96	0.96
10^-6 Microgram to Milligram / liters to m3	0.000001	0.000001	0.000001	0.000001	0.000001	0.000001
Dose-inh	0.00000102	0.00000309	0.00000244	0.00000211	0.00000095	0.00000082
Construction Days	546	1.495890411				
potency factor for Diesel	1.1	1.1	1.1	1.1	1.1	1.1
Age Sensitivity Factor	10	10	3	3	1	1
ED	0.25	1.495890411	1.495890411	1.495890411	1.495890411	1.495890411
AT	70	70	70	70	70	70
FAH	0.85	0.85	0.72	0.72	0.73	0.73
Risk for Each Age Group	3.41393E-08	6.16784E-07	1.23807E-07	1.07127E-07	1.628E-08	1.40932E-08
Risk per million Exposed	0.034139254	0.616783996	0.123806822	0.107126692	0.016280035	0.014093165
Cancer Risk Per Million 9-years	0.77					
Cancer Risk Per Million 30-years	0.77					
Cancer Risk Per Million 70-years	0.77					

**BIOLOGICAL TECHNICAL REPORT FOR THE  
GREEN VALLEY LOGISTICS CENTER PROJECT  
IMPERIAL COUNTY, CALIFORNIA**

***Prepared for:***

**COUNTY OF IMPERIAL  
PLANNING AND DEVELOPMENT SERVICES DEPARTMENT  
801 Main Street  
El Centro, California 92243**

***Prepared by:***

**CHAMBERS GROUP, INC.  
9620 Chesapeake Drive, Suite 202  
San Diego, California 92123  
(858) 541-2800**

**July 2023**

**EEC ORIGINAL PKG**

**TABLE OF CONTENTS**

	<b>Page</b>
<b>TABLE OF CONTENTS.....</b>	<b>ii</b>
<b>LIST OF TABLES.....</b>	<b>iv</b>
<b>GLOSSARY OF TERMS AND ACRONYMS .....</b>	<b>v</b>
<b>EXECUTIVE SUMMARY .....</b>	<b>vii</b>
<b>SECTION 1.0 – INTRODUCTION .....</b>	<b>9</b>
1.1 PROJECT BACKGROUND.....	9
1.2 PROJECT LOCATION .....	9
1.3 PROJECT DESCRIPTION.....	10
1.3.1 Access Roads .....	10
1.3.2 Existing Cemetery and Proposed Public Park.....	10
1.3.3 Grain Elevator.....	10
1.3.4 Hay Export and Container Depot.....	10
1.3.5 Produce Export.....	10
1.3.6 Fuel Blending/Transloading and Fueling Station.....	11
1.3.7 General Commodities: Transloading and Warehousing .....	11
1.3.8 Stormwater Retention Basin .....	11
1.3.9 Centralized Water.....	11
<b>SECTION 2.0 – APPLICABLE REGULATIONS .....</b>	<b>12</b>
2.1 FEDERAL.....	12
2.1.1 Clean Water Act.....	12
2.1.2 Federal Endangered Species Act of 1973.....	13
2.1.3 Migratory Bird Treaty Act, as Amended .....	13
2.2 STATE .....	13
2.2.1 California Endangered Species Act .....	13
2.2.2 Sections 1600-1602 of the California Fish and Wildlife Code .....	14
2.2.3 California Environmental Quality Act .....	14
2.2.4 California Native Plant Protection Act .....	14
2.2.5 Porter-Cologne Water Quality Control Act .....	15
<b>SECTION 3.0 – METHODOLOGY .....</b>	<b>16</b>
3.1 LITERATURE REVIEW.....	16
3.2 SOILS .....	16
3.3 JURISDICTIONAL WATERS AND WETLANDS .....	16
3.4 BIOLOGICAL RECONNAISSANCE-LEVEL SURVEY .....	18
3.4.1 Vegetation.....	18

3.4.2	Wildlife.....	18
<b>SECTION 4.0 – RESULTS.....</b>		<b>19</b>
4.1.1	General Conditions.....	19
4.2	SOILS .....	19
4.2.1	Holtville Silty Clay, Wet.....	19
4.2.2	Imperial Silty Clay, Wet.....	19
4.2.3	Imperial-Glenbar Silty Clay Loam, Wet, 0 to 2 percent slopes.....	20
4.2.4	Imperial-Glenbar Silty Clay Loam, Wet, 2 to 5 percent slopes.....	20
4.2.5	Meloland Very Fine Sandy Loams, Wet .....	20
4.2.6	Vint and Indio Very Fine Sandy Loams, Wet .....	20
4.3	VEGETATION COMMUNITIES .....	21
4.3.1	Arrow Weed Thickets .....	21
4.3.2	Bush Seepweed Scrub.....	21
4.3.3	Quailbush Scrub.....	22
4.3.4	Tamarisk Thickets .....	22
4.3.5	Agriculture.....	22
4.3.6	Disturbed.....	22
4.3.7	Bare Ground .....	23
4.3.8	Developed (Earthen Irrigation Channel and Concrete Structure) .....	23
4.4	SPECIAL STATUS SPECIES.....	23
<b>TABLE 1. CRITERIA FOR EVALUATING SPECIAL STATUS SPECIES POTENTIAL FOR OCCURRENCE (PFO)..</b>		<b>24</b>
4.4.1	Special status Plants .....	24
4.4.2	Special Status Wildlife.....	25
4.5	GENERAL PLANTS.....	27
4.6	GENERAL WILDLIFE .....	27
4.7	POTENTIAL JURISDICTIONAL WATERS AND WETLANDS.....	27
4.7.1	Jurisdictional Waters .....	27
4.8	NON-JURISDICTIONAL WATERS.....	28
4.8.1	Wetlands .....	29
<b>SECTION 5.0 – ANALYSIS OF PROJECT EFFECTS .....</b>		<b>31</b>
<b>TABLE 2. SUMMARY OF POTENTIAL VEGETATION COMMUNITY IMPACTS ASSOCIATED WITH PROJECT RELATED ACTIVITIES .....</b>		<b>31</b>
<b>TABLE 3. SUMMARY OF POTENTIAL JURISDICTIONAL WATERS PERMANENT IMPACTS ASSOCIATED WITH PROJECT RELATED ACTIVITIES .....</b>		<b>32</b>
<b>TABLE 4. SUMMARY OF POTENTIAL JURISDICTIONAL WATERS TEMPORARY IMPACTS ASSOCIATED WITH PROJECT RELATED ACTIVITIES .....</b>		<b>33</b>
5.1	ANTICIPATED IMPACTS .....	33
5.2	JURISDICTIONAL WATERS AND WETLANDS .....	34

5.3	MITIGATION MEASURES AND DESIGN CONSIDERATIONS .....	34
5.4	CONCLUSIONS .....	37
<b>SECTION 6.0 – SUMMARY OF PROJECT IMPACTS AND MITIGATION .....</b>		<b>38</b>
<b>SECTION 7.0 – REFERENCES .....</b>		<b>38</b>
<b>SECTION 8.0 – LIST OF PREPARERS .....</b>		<b>40</b>

- APPENDIX A – SITE FIGURES**
- APPENDIX B – SITE PHOTOGRAPHS**
- APPENDIX C – PLANT SPECIES LIST**
- APPENDIX D – WILDLIFE SPECIES LIST**

**LIST OF TABLES**

	<u>Page</u>
Table 1. Criteria for Evaluating Special status Species Potential for Occurrence (PFO) .....	24
Table 2. Summary of Potential Vegetation Community Impacts Associated with Project Related Activities .....	31
Table 3. Summary of Potential Jurisdictional Waters Permanent Impacts Associated with Project Related Activities .....	32
Table 4. Summary of Potential Jurisdictional Waters Temporary Impacts Associated with Project Related Activities .....	33



## GLOSSARY OF TERMS AND ACRONYMS

### Federal

FE	=	Federally listed; Endangered
FT	=	Federally listed; Threatened

### State

SSC	=	State Species of Special Concern
-----	---	----------------------------------

### Abbreviations

°F	Degrees Fahrenheit
AQM	Salton Sea Air Quality Mitigation Plan
BGEPA	Bald and Golden Eagle Protection Act
BMPs	Best Management Practices
CDFW	California Department of Fish and Wildlife
CEQA	California Environmental Quality Act
CESA	California Endangered Species Act
CFR	Code of Federal Regulations
Chambers Group	Chambers Group, Inc.
CNDDB	California Natural Diversity Database
CNPS	California Native Plant Society
CRPR	California Rare Plant Rank
CWA	Clean Water Act
DRECP	Desert Renewable Energy Conservation Plan
ESA	Endangered Species Act
FESA	Federal Endangered Species Act
Ft.	Feet
GCP	General Conservation Plan
GIS	Geographic Information System
GPM	Gallons Per Minute
GPS	Global Positioning System
HCP	Habitat Conservation Plan
IID	Imperial Irrigation District
ITP	Incidental Take Permit
MBTA	Migratory Bird Treaty Act
MSCP	Multiple Species Conservation Plan
NCCP	Natural Community Conservation Plan
NPPA	Native Plant Protection Act
NRCS	Natural Resources Conservation Service
NWI	National Wetlands Inventory
OHWM	Ordinary High Water Mark
PFO	Potential for Occurrence
QSP	Quantification Settlement Agreement
RWQCB	Regional Water Quality Control Board
SQ. FT.	Square Feet
SSC	California Species of Special Concern

SWRCB	State Water Resources Control Board
TNW	Traditional Navigable Waterway
USACE	U.S. Army Corps of Engineers
USDA	U.S. Department of Agriculture
USFWS	U.S. Fish and Wildlife Service
USGS	U.S. Geological Survey
WDR	Waste Discharge Report
WoUS	Waters of the United States of America

## EXECUTIVE SUMMARY

This Biological Technical Report (BTR) has been prepared for the Imperial County Planning and Development Services Department (County), as the lead agency under the California Environmental Quality Act (CEQA), for the Green Valley Logistics Center (Project or Proposed Project). Tomcat Development LLC (Applicant) proposes the development and operation of rail tracks that tie into the adjacent Union Pacific Railroad right-of-way, a grain elevator, a veteran's memorial area adjacent to the existing cemetery, a fueling station, and areas for transloading and storage of general commodities. The Applicant is proposing the Project to facilitate in-bound and out-bound trains with commodities as well as transloading to and from trucks. Further, the Project's Tentative Tract Map proposes to re-configure the existing parcels, and a grant of road right-of-way to Imperial in County for an Industrial Street, as defined in the Mesquite Lake Specific Plan. Each of these elements associated with the Proposed Project are explained in further detail within Section 1.3 of this report. The initial site survey was conducted over an approximately 293-acre area surrounding Proposed Project features (Study Area). Impacts to habitat were calculated for all project features and anticipated work areas (Proposed Project Area), as described in Section 1.3.

The purpose of this report is to document the biological resources identified as present or potentially present on the Proposed Project; identify potential biological resource impacts resulting from the Proposed Project; identify waters potentially under state and/or federal jurisdiction; and recommend measures to avoid, minimize, and/or mitigate significant impacts consistent with federal, state, and local rules and regulations under CEQA in support of the Mesquite Lake Specific Plan. This BTR incorporates the results of a biological reconnaissance and delineation of waters survey, and desktop analysis of the area.

Overall, the Study Area is located on flat ground with minor topographical changes, with the largest elevation change associated with the Imperial Irrigation District (IID) Newsie Drain Number 1-A along the north perimeter of the site. The majority of the site consists of agriculture areas and Quailbush Scrub, with Bush Seepweed Scrub, Disturbed areas, and other vegetation communities and land types interspersed.

No special status plant species were recorded within 5 miles of the Proposed Project, poor quality habitat to support special status plant species was identified on site, and none were identified during the reconnaissance survey. Therefore, no impacts to special status plants are anticipated as a result of the Proposed Project.

A total of 10 special status wildlife species were evaluated for their potential occurrence within the Proposed Project site. Based on the reconnaissance survey, mountain plover (*Charadrius montanus*) has a moderate Potential for Occurrence (PFO), San Diego black-tailed jackrabbit (*Lepus californicus bennettii*) has a high PFO, and burrowing owl (*Athene cunicularia*) was identified as present in the Proposed Project site. Approximately sixteen burrowing owls and burrowing owl signs were observed in the southwest portion of the Study Area, along the edges of the concrete-lined irrigation channels. No impacts to the channels in this area are anticipated.

Various mitigation measures are proposed to minimize potential impacts to the above listed wildlife and plant species, such as but not limited to: any trimming and/or removal of native habitat shall be conducted outside of the bird breeding season (outside of the period from February 15 through August 30); if work is proposed to occur within the nesting bird season, a nesting bird survey should be conducted prior to construction related activities; focused surveys for burrows and burrowing owls should be conducted; and

an environmental awareness training should be provided to all construction personnel prior to construction related activities.

Based on the data collected and analyzed in this jurisdictional delineation, Chambers Group has identified and delineated approximately 0.04 acre of permanent and 0.01 acre of temporary impacts of non-wetland waters of the United States (WoUS) within the overall Study Area that are subject to the potential regulatory authority of the USACE under Section 404 of the Clean Water Act.

Approximately 0.04 acre of permanent and 0.01 acre of temporary impacts of non-wetland waters of the State within the overall Study Area that are subject to the potential regulatory authority of the RWQCB jurisdiction are regulated under Section 401 of the Clean Water Act. Approximately 0.13 acre of permanent and 0.05 acre of temporary impacts are subject to potential CDFW jurisdiction under Sections 1600 et seq. of the California Fish and Game Code.

Construction related impacts to the Proposed Project would result in approximately 261 acres of permanent impacts to vegetation communities. This includes approximately 97 acres of permanent impacts to native vegetation, 132 acres of non-native vegetation, and 32 acres of developed areas.

Construction related impacts to the Proposed Project would result in approximately 16 acres of temporary impacts to vegetation communities, including approximately 1 acre of native habitat, 14 acres of non-native habitat, and 2 acres of developed areas.

## **SECTION 1.0 – INTRODUCTION**

Chambers Group has been contracted by the Imperial County Planning and Development Services Department to complete a Biological Technical Report (BTR) for the proposed Green Valley Logistics Center Project. The Proposed Project includes the development and operation of three proposed loop tracks, a ladder track manifest yard and various rail spurs that tie into the adjacent Union Pacific Railroad right-of-way, a grain elevator, a veteran’s memorial area adjacent to the existing cemetery, a fueling station, and areas for warehousing, transloading and storage of general commodities. The Project is proposed within approximately 293.32 acres of primarily open space north of Dahlia Lateral 8, west of the Union Pacific Railroad, east of State Route (SR) 86, and south of the Imperial Irrigation District (IID) Newside Drain No. 1-A (Appendix A Figure 1).

Chambers Group completed a literature review and reconnaissance-level survey for proposed work activities to develop the Green Valley Logistics Center (Proposed Project). The survey identified vegetation communities, potential for the occurrence of special status species, or habitats that could support special status wildlife species, and a preliminary jurisdictional delineation (PJD) of potential wetland and waters on site. Information contained in this Biological Technical Report is in accordance with accepted scientific and technical standards that are consistent with the requirements of United States Fish and Wildlife Service (USFWS), United States Army Corps of Engineers (USACE), Regional Water Quality Control Board (RWQCB), and the California Department of Fish and Wildlife (CDFW).

### **1.1 PROJECT BACKGROUND**

The Mesquite Lake Specific Plan (Specific Plan) consists of approximately 5,100 acres located in central Imperial County, north of the City of Imperial and south of Brawley. As part of the 1993 General Plan the County of Imperial designated the site, bordered to the west by State Route (SR) 86, to the north by Carey Road, to the east by SR 111, and to the south by Harris Road, as a Specific Plan Area (SPA) to establish an area for new job-producing light, medium, and heavy industrial uses. It proposed that the project area be developed with approximately 4,222 acres of industrial uses, 640 acres of agriculture and aquaculture, 69 acres of government/special public, and 169 acres of major roads. Agriculture-related uses were expected to include packing and processing, waste processing, equipment manufacturing and maintenance, and production and distribution of farm chemicals.

In February 2006 a Master Environmental Impact Report (MEIR) was prepared to address potential impacts associated with implementation of the project and included evaluation of four individual development projects that had been filed with the Imperial County Planning and Development Services Department for concurrent processing with the Specific Plan: Liberty X Biofuels Power LLC, Holly Sugar/Imperial Bioresources LLC, Palo Verde Valley Disposal Service, and LEAC LLC Compressed Hay Facility.

The Green Valley Logistics Center Project is located at the southwest corner of the Specific Plan.

### **1.2 PROJECT LOCATION**

The Proposed Project is located between the City of Imperial and Brawley in Imperial County, California. The Proposed Project area is located in the Brawley USGS 7.5-min quadrangle, within Section 31, Township 14 South, Range 14 East. The Proposed Project site is primarily open space dominated by minimal topographical variation. The Proposed Project site is bordered by Dahlia Lateral 8 to the south, the Union



Pacific Railroad to the west, State Route (SR) 86 to the west, and the Imperial Irrigation District (IID) Newside Drain No. 1-A to the north. The elevation at the Proposed Project site ranges from approximately 70 to 90 ft. below mean sea level (bmsl). The proposed development of the Study Area lies outside the scope of the IID Habitat Conservation Plan (HCP), according to communication with the County of Imperial.

### **1.3 PROJECT DESCRIPTION**

The following sections detail the Proposed Project features, their purpose, and how they will be developed.

#### **1.3.1 Access Roads**

It is proposed that the primary access to all project components would be from a new 72-foot-wide industrial road that would tie into the State Route 86 with a right in driveway and a right out driveway.

#### **1.3.2 Existing Cemetery and Proposed Public Park**

The existing Memory Gardens Cemetery is currently on the western end of the Proposed Project property. The property lines are proposed to be adjusted to encompass an approximate 10-acre area, which would be fenced off from the rest of the Proposed Project. The new area to the east of the cemetery would be developed into a public park in honor of veterans. Access to the cemetery and park would continue being from the existing and historical access from State Route 86, or from the new right in and right out driveways.

#### **1.3.3 Grain Elevator**

The development of a grain elevator is proposed for the receiving of corn and other similar grain products via rail and subsequent distribution to cattle feeding yards. The grain elevator would be located on approximately 10 acres in the middle of the Proposed Project site.

#### **1.3.4 Hay Export and Container Depot**

A hay export and container depot is proposed to be developed on approximately 130 acres on the eastern half of the Proposed Project property, adjacent to the Union Pacific Railroad right-of-way. The three proposed loop tracks that tie to the Union Pacific Railroad would be located in this area, including a ladder track, and various spurs. The rail system would facilitate in-bound and out-bound trains of commodities as well as transloading to and from trucks and warehousing. Hay would be transported inbound on trucks and outbound on rail. Containers would be transported both inbound and outbound on rail and truck.

#### **1.3.5 Produce Export**

The produce export component of the Proposed Project would be on an approximately 10-acre parcel of land. Inbound transport would be by truck and outbound transport by rail.

**1.3.6 Fuel Blending/Transloading and Fueling Station**

The proposed fuel blending and transloading, and the fuel station would be located on a total of approximately 20 acres. The fuel transloading would occur inbound by rail and outbound by truck. The fueling station, which would include but not be limited to CNG, would be used to fuel trucks already onsite and for public use.

**1.3.7 General Commodities: Transloading and Warehousing**

A general commodities transloading and warehousing facility is proposed to be developed in the southerly portion of the Proposed Project site. Commodities would be transported inbound by rail and outbound by truck.

**1.3.8 Stormwater Retention Basin**

The entire Proposed Project area is proposed to drain into a new communal stormwater retention basin at the northeast corner of the Proposed Project site, north of the hay export and container depot. The approximately 17-acre retention basin would continue to drain into the existing Imperial Irrigation District (IID) Newside Drain Number 1-A.

**1.3.9 Centralized Water**

A 2-acre lot in the center of the Proposed Project site is proposed to be developed so that the IID Dahlia Lateral 8 could provide both potable and fire water to the site.

## SECTION 2.0 – APPLICABLE REGULATIONS

The following federal and state, and local regulations and policies pertain to biological resources and are relevant to the Proposed Project.

### 2.1 FEDERAL

The following are federal policies that apply to the Proposed Project.

#### 2.1.1 Clean Water Act

The purpose of the Clean Water Act (CWA) is to “restore and maintain the chemical, physical, and biological integrity of the nation’s waters.” Section 404 of the CWA prohibits the discharge of fill material into waters of the U.S. without a permit from the USACE. The definition of waters of the U.S. includes rivers, streams, estuaries, the territorial seas, ponds, lakes, and wetlands. Wetlands are defined as those areas “that are inundated or saturated by surface or groundwater at a frequency and duration sufficient to support, and that under normal circumstances do support, a prevalence of vegetation typically adapted for life in saturated soil conditions” (33 CFR § 328.3(b)). The goals and standards of the CWA are enforced through permit provisions. The U.S. Environmental Protection Agency also has authority over wetlands and may override a USACE permit.

When a project may create impacts for wetlands, the project requires a permit or a waiver. Substantial impacts to wetlands may require an Individual Permit. Projects that only minimally affect wetlands may meet the conditions of one of the existing Nationwide Permits.

The State of California (State) regulates discharge of material into waters of the State pursuant to Section 401 of the Clean Water Act and the California Porter-Cologne Water Quality Control Act (California Water Code, Division 7, §13000 et seq.). A Water Quality Certification or waiver pursuant to Section 401 of the CWA is required from the RWQCB for Section 404 permit actions.

#### **Clean Water Rule**

On September 12, 2019, the Environmental Protection Agency (EPA) and Department of the Army signed a final rule to repeal the 2015 Clean Water Rule (2015 Rule) and re-codify the regulatory text defining “waters of the United States” that existed prior to the 2015 Rule. The new regulations went into effect on December 23, 2019. One of the proposed changes includes ephemeral features that contain water only during or in response to rainfall would no longer be considered “waters of the United States” under the jurisdiction of the USACE. On August 28, 2019, the Office of Administrative Law approved the State Wetland Definition and Procedures for Discharges of Dredged or Fill Material to “waters of the State”. The procedures went into effect on May 28, 2020. Under these new regulations, the State Water Resources Control Board and its nine RWQCBs will assert jurisdiction over all existing “waters of the United States”, and all waters that would have been considered “waters of the United States” under the 2015 Rule. Thus, the “waters of the United States” that would no longer be under USACE jurisdiction would be under RWQCB jurisdiction.

The EPA and USACE are in receipt of the U.S. District Court for the District of Arizona’s August 30, 2021, order vacating and remanding the Navigable Waters Protection Rule in the case of *Pascua Yaqui Tribe v. U.S. Environmental Protection Agency*. On October 22, 2019, the EPA and USACE published a final rule to

repeal the 2015 Clean Water Rule: Definition of “Waters of the United States” (“2015 Rule”), which amended portions of the Code of Federal Regulations (CFR), and to restore the regulatory text that existed prior to the 2015 Rule. The final “Revised Definition of ‘Waters of the United States’” rule (the “2023 Rule”) became effective on March 20, 2023. Therefore, this PJD is consistent with the 2023 Rule and includes measurement of the Ordinary High Water Mark (OHWM) to determine Waters of the United States (WoUS).

### **2.1.2 Federal Endangered Species Act of 1973**

When a private project that has no federal funding and for which no federal action is required may affect a listed species, the private applicant may receive authorization for incidental take of species listed under the Federal Endangered Species Act (FESA). In these situations, Section 10 of the FESA provides for issuance of incidental take permits (ITPs) to private entities with the development of an HCP. An ITP allows take of the species that is incidental to another authorized activity.

### **2.1.3 Migratory Bird Treaty Act, as Amended**

The Migratory Bird Treaty Act (MBTA) of 1918, as amended (16 USC 703-711), provides legal protection for almost all bird species occurring in, migrating through, or spending a portion of their life cycle in North America by restricting the killing, taking, collecting, and selling or purchasing of native bird species or their parts, nests, or eggs. USFWS determined it was illegal under the MBTA to directly kill or destroy an active nest (nest with eggs or nestlings) of, nearly any bird species (with the exception of non-native species through the MBTA Reform Act of 2004). Certain game bird species are allowed to be hunted for specific periods determined by federal and state governments. The intent of the MBTA is to eliminate any commercial market for migratory birds, feathers, or bird parts, especially for eagles and other birds of prey. As authorized by the MBTA, the USFWS issues permits to qualified applicants for the following types of activities:

- Falconry
- Raptor propagation
- Scientific collecting
- Special purposes, such as rehabilitation, education, migratory game bird propagation, and salvage
- Take of depredating birds, taxidermy, and waterfowl sale and disposal

The regulations governing migratory bird permits can be found in Title 50, Part 13 (General Permit Procedures) and Part 21 (Migratory Bird Permits) of the CFR.

## **2.2 STATE**

The following sections detail specific California State regulations are applicable to the Proposed Project.

### **2.2.1 California Endangered Species Act**

The California Endangered Species Act (CESA; California Fish and Wildlife Code Sections 2050-2116) parallels the FESA. As a responsible agency, CDFW has regulatory authority over species State listed as endangered and threatened. The State Legislature encourages cooperative and simultaneous findings between State and federal agencies. Consultation with CDFW is required for projects with the potential

to affect listed or candidate species. CDFW would determine whether a reasonable alternative would be required for the conservation of the species. CESA prohibits the “take” of these species unless an ITP is granted. Under California Fish and Wildlife Code Section 2081 (ITP), CDFW can authorize the “take” of a listed species (with exception to fully protected species) if the “take” of the listed species is incidental to carrying out an otherwise lawful project that has been approved under the California Environmental Quality Act (CEQA). Section 2080.1 allows for “take” once an applicant obtains a federal ITP which can be approved (Consistency Determination letter) within 30 days by the CDFW Director. If the federal Incidental Take Statement is determined not to be consistent with CESA, then application for a State ITP (2081) is required.

CDFW has designated certain species native to California as Species of Special Concern to “focus attention on wildlife at conservation risk by the Department, other State, Local and Federal governmental entities, regulators, land managers, planners, consulting biologists, and others; stimulate research on poorly known species; achieve conservation and recovery of wildlife before they meet CESA criteria for listing as threatened or endangered.”

### **2.2.2 Sections 1600-1602 of the California Fish and Wildlife Code**

Pursuant to Division 2, Chapter 6, Sections 1600-1602 of the California Fish and Wildlife Code, CDFW regulates all diversions, obstructions, or changes to the natural flow or bed, channel, or bank of any river, stream, or lake, which supports fish or wildlife. CDFW defines a “stream” (including creeks and rivers) as “a body of water that flows at least periodically or intermittently through a bed or channel having banks and supports fish or other aquatic life. This includes watercourses having surface or subsurface flow that supports or has supported riparian vegetation.” CDFW’s definition of “lake” includes “natural lakes or man-made reservoirs.” Features were delineated by measuring the outer width and length boundaries, consisting of either the top of bank (TOB) measurement or the extent of associated riparian or wetland vegetation (whichever is greater)..

### **2.2.3 California Environmental Quality Act**

The CEQA (Public Resources Code, Sections 21000-21177) requires that State and local agencies consider environmental consequences and project alternatives before a decision is made to implement a project requiring State or local government approval, financing, or participation by the State of California. In addition, CEQA requires the identification of ways to avoid or reduce environmental degradation or prevent environmental damage by requiring implementation of feasible alternatives or mitigation measures.

### **2.2.4 California Native Plant Protection Act**

The Native Plant Protection Act (NPPA) of 1977 (California Fish and Game Code §§ 1900-1913) was created with the intent to “preserve, protect, and enhance rare and endangered plants in this State.” The NPPA is administered by the CDFW. The California Fish and Game Commission has the authority to designate native plants as “endangered” or “rare” and to protect them from take. Rare plants protected by CDFW generally include species with California Rare Plant Ranking (CRPR) 1A, 1B, 2A, and 2B of the CNPS Inventory of Rare and Endangered Vascular Plants of California. In addition, sometimes CRPR 3 and 4 plants are considered rare if the population has local significance in the area and is impacted by a project. Section 1913(b) includes a specific provision to allow for the incidental removal of endangered or rare



plant species, if not otherwise salvaged by CDFW, within a ROW to allow a public utility to fulfill its obligation to provide service to the public.

When the CESA was passed in 1984, it expanded on the original NPPA, enhanced legal protection for plants, and created the categories of “threatened” and “endangered” species to parallel the FESA. The CESA converted all rare wildlife to threatened species under the NPPA, but did not do so for rare plants, which resulted in three listing categories for plants in California: rare, threatened, and endangered. The NPPA remains part of the California Fish and Game Code, and mitigation measures for impacts to rare plants are specified in a formal agreement between the CDFW and a project proponent.

#### **2.2.5 Porter-Cologne Water Quality Control Act**

The State of California regulates discharge of material into waters of the State pursuant to Section 401 of the Clean Water Act and the California Porter-Cologne Water Quality Control Act (California Water Code, Division 7, §13000 et seq.). The Porter-Cologne Water Quality Control Act of 1966 (California Water Code §§ 13000-13999.10) mandates that activities that may affect waters of the State shall be regulated to attain the highest quality. The State Water Resources Control Board (SWRCB) and the local RWQCB are the relevant permitting agencies. RWQCB provides regulations for a “non-degradation policy” that are especially protective of areas with high water quality. Porter-Cologne reserves the right for the State of California to regulate activities that could affect the quantity and/or quality of surface and/or ground waters, including isolated wetlands, within the State. The SWRCB and its nine RWQCBs will assert jurisdiction over all existing “waters of the United States”, and all waters that would have been considered “waters of the United States” under the 2015 Rule. If the project is proposed to discharge into waters of the State, a Waste Discharge Report (WDR), or a waiver to WDRs, must be filed before beginning discharge.

## SECTION 3.0 – METHODOLOGY

### 3.1 LITERATURE REVIEW

Prior to performing the field survey, existing documentation relevant to the Study Area was reviewed. The most recent records of the California Natural Diversity Database (CNDDDB) managed by CDFW (CDFW 2022), the USFWS Critical Habitat Mapper (USFWS 2022) and the California Native Plant Society's Electronic Inventory (CNPSEI) of Rare and Endangered Vascular Plants of California (CNPS 2022) were reviewed for the following quadrangles containing and surrounding the Study Area: *Westmorland West, Westmorland East, Wiest, Brawley NW, Brawley, Alamorio, Seely, El Centro, and Holtville West*, California USGS 7.6 minute quadrangles. These databases contain records of reported occurrences of federal- or state-listed endangered or threatened species, California Species of Special Concern (SSC), or otherwise special status species or habitats that may occur within or in the immediate vicinity of the Study Area.

### 3.2 SOILS

Before conducting the survey, soil maps for Imperial County were referenced online (<https://websoilsurvey.sc.egov.usda.gov/App/WebSoilSurvey.aspx>) to determine the soil types found within the Study Area site. Soils were determined in accordance with categories set forth by the U.S. Department of Agriculture (USDA) Soil Conservation Service and by referencing the USDA Natural Resources Conservation Service (NRCS) Web Soil Survey (USDA 2022).

### 3.3 JURISDICTIONAL WATERS AND WETLANDS

Chambers Group biologists Erik Olmos and Jessica Calvillo conducted a delineation of jurisdictional waters regulated by the USACE, RWQCB, and CDFW for the Project site on August 22, 2022.

For the purpose of determining hydrologic connectivity to a Traditional Navigable Water (TNW), the most recent records of the USFWS National Wetlands Inventory (NWI; USFWS 2022) data, U.S. Geological Survey (USGS) National Hydrography Dataset (NHD) blue-lined drainages, aerial imagery, and topographic maps were reviewed; and all features were inspected in the field on and off site for true connectivity. Potential USACE / RWQCB / CDFW jurisdictional areas identified during the literature search and aerial image analysis were field checked for the presence of definable channels, soils, wetland vegetation, riparian habitat, and hydrology. Each drainage was examined in the field, and the channel banks were examined for signs of flow, terraces, drift deposits and other indicators that would determine the location of the OHWM. Climate and flow frequency were taken under consideration during the survey effort. Data were collected using a combination of records entered into ESRI ArcGIS Collector© and hand-written field notes.

Potential wetland habitats were evaluated using the methodology set forth in the *1987 Corps of Engineers Wetlands Delineation Manual* (1987 Wetland Manual; USACE 1987) and the *Regional Supplement to the Corps of Engineers Wetland Delineation Manual: Arid West Region (version 2.0)* (2008 Arid West Supplement; USACE 2008). The methods set forth in the 1987 Wetland Manual and the 2008 Arid West Supplement involve the delineation of wetlands based on the presence of three wetland parameters: a predominance of hydrophytic vegetation, wetland hydrology, and hydric soils. These wetland parameters are discussed in greater detail below.

## Hydrophytic Vegetation

Hydrophytic vegetation is defined as “the sum total of macrophytic plant life growing in water or on a substrate that is at least periodically deficient in oxygen as a result of excessive water content” (USACE 1987). The potential wetland areas were surveyed by walking through the Survey Area and making observations of those areas exhibiting characteristics of jurisdictional wetlands.

Areas supporting plant life potentially indicative of wetlands were evaluated in the field according to current USACE wetland delineation procedures described in the 1987 Wetland Manual (USACE 1987) and the 2008 Arid West Supplement (USACE 2008). The dominant and subdominant plant species present in the sample pits of these potential wetland areas were identified and their wetland indicator status noted based on the current National Wetland Plant List (USACE 2020). The list was referenced to classify identified plants using the following categories: obligate wetland (OBL; almost always occurs in wetlands), facultative wetland (FACW; usually occurs in wetlands but occasionally found in non-wetlands), facultative (FAC; equally likely to occur in wetlands and non-wetlands), facultative upland (FACU; usually occurs in non-wetlands but occasionally found in wetlands), and obligate upland (UPL; almost always occurs in non-wetlands).

## Hydric Soils

A hydric soil is a soil that is saturated, flooded, or ponded long enough during the growing season to develop anaerobic conditions that favor the growth and regeneration of hydrophytic vegetation (USACE 1987). Hydric soil indicators are formed predominantly by the accumulation or loss of iron, manganese, sulfur, or carbon compounds (USACE 2008) due to periods of anaerobic conditions in the soil. The hydric soil criterion is considered satisfied at a location if soils in the area can be inferred to have a high groundwater table, evidence of prolonged soil saturation, or any indicators suggesting a long-term reducing environment in the upper 18 inches of the soil profile are present.

Potential hydric soils were investigated within the Study Area. Sample soil pit locations were selected, and a hole was dug to a typical depth of 18 inches (unless prevented by some occluding material) or occasionally deeper to determine soil color, evidence of soil saturation, depth to shallow groundwater, and indicators of a reducing soil environment (e.g., redox concentrations or pore linings, gleyed soils, hydrogen sulfide odor). Soil matrix colors were classified using the Munsell Soil-Color Charts (Munsell Color 2009).

## Wetland Hydrology

The presence of wetland hydrology indicators confirm that inundation or saturation has occurred on a site but may not provide information about the timing, duration, or frequency of the event. Hydrology features are generally the most ephemeral of the three wetland parameters (USACE 2008).

Hydrologic information for the site was obtained by reviewing USGS topographic maps and by directly observing hydrology indicators in the field. The wetland hydrology criterion is considered satisfied at a location if, based upon the conclusions inferred from the field observations, an area has a high probability of being periodically inundated or has soils saturated to the surface at some time during the growing season to develop anaerobic conditions in the surface soil environment, especially the root zone (USACE 1987). If at least one primary indicator or at least two secondary indicators are found at a sample pit, the wetland hydrology criterion is considered satisfied.

### **3.4 BIOLOGICAL RECONNAISSANCE-LEVEL SURVEY**

Chambers Group biologists, Erik Olmos and Jessica Calvillo, conducted the general reconnaissance survey within the Proposed Project site to identify the potential for occurrence of special status species, vegetation communities, or habitats that could support special status wildlife species. The survey was conducted on foot throughout the Study Area between 0645 and 1155 hours on August 5, 2022. Weather conditions during the survey included temperatures ranging from 81 to 99 degrees Fahrenheit, with zero percent cloud cover, winds ranging from 1 to 3 miles per hour, and no precipitation. Chambers Group biologist Heather Franklin dug and analyzed the soil pits on September 13, 2022. Photographs of the Study Area were recorded to document existing conditions (Appendix B).

#### **3.4.1 Vegetation**

All plant species observed within the Study Area were recorded. Vegetation communities within the Study Area were identified, qualitatively described, and mapped using ArcGIS. Plant communities were determined in accordance with the *Manual of California Vegetation, Second Edition* (Sawyer et al. 2009). Plant nomenclature follows that of *The Jepson Manual* (Baldwin et al. 2012). A comprehensive list of the plant species observed during the survey is provided in Appendix C.

#### **3.4.2 Wildlife**

All wildlife and wildlife signs observed and detected, including tracks, scat, carcasses, burrows, excavations, and vocalizations, were recorded. Additional survey time was spent in those habitats most likely to be utilized by wildlife (native vegetation, wildlife trails, etc.) or in habitats with the potential to support state- and/or federal-listed or otherwise special status species. Notes were made on the general habitat types, species observed, and the conditions of the Study Area. A comprehensive list of the wildlife species observed during the survey is provided in Appendix D.

## SECTION 4.0 – RESULTS

The following sections detail the results of the literature review and reconnaissance survey conducted within the Study Area.

### 4.1.1 General Conditions

The Study Area is located on flat land with overall minimal topographical variation, bordered to the west by SR 86, to the east by the Union Pacific Railroad, to the south by the Dahlia Lateral 8 concrete-lined irrigation channels, and to the north by the earthen IID Newside Drainage Number 1-A. The elevational range of the Study Area is from approximately 90 feet below mean sea level (lowest point) to 70 feet below mean sea level (highest point), an overall elevational difference of approximately 20 feet, with the major topographical relief primarily limited to the Newside Drainage. Agriculture fields are located in the middle, south, and southwest of the Study Area while Quailbush Scrub is located on the north and east sides of the site. The developed Memory Gardens Cemetery is located at the west end of the Study Area, Bush Seepweed Scrub is located north of the agriculture fields, and Disturbed land is primarily located west and east of the fields. The four other vegetation communities and land types – Bare Ground, Tamarisk Thickets, Arrow Weed Thickets, and Developed (Earthen Irrigation Channel and Concrete Structure) – are interspersed throughout the Study Area.

## 4.2 SOILS

After review of USDA Soil Conservation Service and by referencing the USDA NRCS Web Soil Survey (USDA 2022), it was determined that the Study Area is located within the Imperial Valley area (CA683). Based on the results of the database search, the Study Area is composed of the following five soil types described in the subsections below and is represented in Figure 2.

### 4.2.1 Holtville Silty Clay, Wet

The Holtville soils are on nearly level flood plains and basins at elevations of about 800 feet above to 230 feet below sea level. They are well drained, with low runoff and slow permeability. Slopes are 0 to 3 percent. The Holtville soils formed in mixed and stratified alluvium and lacustrine sediments. Vertical tongues 1/2 to 2 inches wide of sandy or coarser soil fill old cracks to depths greater than 20 inches. Unfilled soil cracks range from 1 mm to greater than 1 cm wide at a depth of 20 inches or more. The material below the clay or silty clay is dominantly loamy very fine sand, but some thick strata are silt loam to loamy fine sand. Strata as much as 1 inch thick of contrasting texture are in both the fine-textured upper layers and the coarse-textured lower layers. It is usually massive, but some pedons have platy structure because of stratification. The soil is dominantly moderately alkaline, but some pedons have strata that are strongly alkaline. It is calcareous throughout with disseminated lime and has soft threads and masses of gypsum in some pedons.

### 4.2.2 Imperial Silty Clay, Wet

The Imperial soils are nearly level to gently sloping and are on flood plains and in old lake beds at elevations of 235 feet below sea level to 300 feet above mean sea level (amsl). They formed in calcareous alluvium from mixed sources. The soil is nearly always dry and is not continuously moist for as long as 60 days. Very thin silty and very fine sandy strata are present in soil that has not been mixed by cultivation. Organic matter decreases irregularly with depth. Dry soil has cracks more than 1cm. wide at a depth of



50cm. Tongues ranging from silty clay to loamy sand fill old vertical cracks. The soil has platy or blocky structure. Dry fragments may exhibit conchoidal fracture. The soil is dominantly moderately alkaline but ranges to strongly alkaline. In addition to disseminated lime, some pedons have soft threads and bodies of lime and gypsum. Efflorescences of gypsum and other salts are on the faces of some peds.

#### **4.2.3 Imperial-Glenbar Silty Clay Loam, Wet, 0 to 2 percent slopes**

The Imperial soils are nearly level to gently sloping and are on flood plains and in old lake beds at elevations of -235 ft. to 300 ft. amsl. The Glenbar series consists of very deep, well drained soils that formed in stratified stream alluvium. The soil is dry to intermittently moist and is highly dependent on winter and summer monsoonal rains for moisture. The mean annual soil temperature at a depth of 20 inches ranges from 72 to 78 °F. Rock fragments or strata of contrasting texture are lacking to a depth of 40 inches or more. Very thin silty and very fine sandy strata are present in soil that has not been mixed by cultivation with organic matter that decreases irregularly with depth. Tongues ranging from silty clay to loamy sand fill old vertical cracks. The soil has platy or blocky structure and dry fragments may exhibit conchoidal fracture. The soil is dominantly moderately alkaline but can also be strongly alkaline.

#### **4.2.4 Imperial-Glenbar Silty Clay Loam, Wet, 2 to 5 percent slopes**

Similar to that described above in Section 4.2.3 however with a higher degree of slope.

#### **4.2.5 Meloland Very Fine Sandy Loams, Wet**

The Meloland soils are in nearly level lacustrine basins and flood plains in the deserts at elevations of about 700 feet above to 230 feet below sea level. Slopes are 0 to 1 percent. Typically, Meloland soils have light brown and very pale brown, calcareous very fine sandy loam, loamy fine sand and silt loam upper horizons underlain by pink calcareous silty clay at depth of 26 inches that extends to a depth of 71 inches. The organic matter decreases irregularly with increasing depth. In some places, the fine textured strata have vertical tongues 1/2 to 2 inches wide of soil of texture like that of the overlying horizons. These are fillings in old cracks. The strata throughout the soil are massive or have platy structure due to stratification. The plowed layer may have structure that was formed by tillage. Lime is usually disseminated but both lime and gypsum are in soft bodies or concretions in some places. Generally, the soil ranges from mildly to moderately alkaline, but a few pedons have individual strata that are strongly alkaline.

#### **4.2.6 Vint and Indio Very Fine Sandy Loams, Wet**

Vint soils are on flood plains and have slopes of 0 to 3 percent. They formed in stratified stream alluvium from mixed sources at elevations from 230 feet below sea level to 2500 feet above. Mean annual precipitation is about 7 inches and falls as summer thunderstorms and gentle winter rain. Vint soils are excessively drained, with very slow runoff and moderately rapid permeability. Indio soils are on lacustrine basins, alluvial fans and floodplains at elevations ranging from about 1400 feet above sea level to 230 feet below sea level. Slopes are 0 to 3 percent except for a few low banks next to stream channels. The soils formed in young calcareous, silty mixed alluvium. The mean annual precipitation is 3 to 10 inches. Indio soils are well or moderately well drained, with slow runoff and moderate permeability.

### 4.3 VEGETATION COMMUNITIES

Six vegetation communities were observed within the Study Area: Arrow Weed Thickets, Bush Seepweed Scrub, Quailbush Scrub, Agriculture, Tamarisk Thickets and Disturbed vegetation. In addition, three land types were present in the Study Area: Bare Ground, Developed/Concrete Infrastructure and Developed/Earthen Irrigation Channel. A map showing the vegetation communities observed and land types within the Study Area is provided in Appendix A Figure 4, and the communities are described in the following subsections.

#### 4.3.1 Arrow Weed Thickets

Arrow Weed Thickets are found around springs, seeps, irrigation ditches, canyon bottoms, stream borders, seasonally flooded washes (Sawyer et al. 2009). Soils are alluvial- or aeolian-derived sands or clay loams that are usually alkaline or saline. Stands occur as dense, narrow thickets along permanent springs and slow-flowing streams or as part of vegetation mosaics that surround alkali springs and marshes. According to the Manual of California Vegetation (Second Edition) community membership rules, there must be greater than or equal to 2 percent absolute cover of arrow weed (*Pluchea sericea*) and no other shrubs species greater than or equal to the arrow weed cover in the shrub canopy. Arrow weed is dominant or co-dominant in the shrub canopy with iodine bush (*Allenrolfea occidentalis*), four-wing saltbush (*Atriplex canescens*), quailbush (*Atriplex lentiformis*), sandbar willow (*Salix exigua*), bush seepweed (*Suaeda nigra*) and tamarisk (*Tamarix* spp.). Emergent trees may be present at low cover, including Fremont cottonwood (*Populus fremontii*), black cottonwood (*Populus trichocarpa*) or honey mesquite (*Prosopis glandulosa*). Shrubs are typically less than 5 meters in height with a canopy that is intermittent to continuous. The herbaceous layer is sparse with seasonal annuals (Sawyer et al. 2009).

Areas with Arrow Weed Thicket vegetation are only present within 0.69 acres on the top of the banks of developed earthen channels and concrete ditches. Native plant species found on the Study Area typical of this vegetation community included a 50 to 75 percent cover of arrow weed.

#### 4.3.2 Bush Seepweed Scrub

Bush Seepweed Scrub is found within flat to gently sloping valley bottoms, playas, and toe slopes adjacent to alluvial fans, and bajadas. Soils within this community are deep; saline or alkaline (Sawyer et al. 2009). According to the Manual of California Vegetation (Second Edition) community membership rules, there must be greater than 2 percent absolute cover of bush seepweed (*Suaeda nigra*) and no other shrubs species greater than or equal to the bush seepweed cover in the shrub canopy. Alkali goldenbush (*Isocoma acradenia*) or bush seepweed is dominant or co-dominant in the shrub layer with iodine bush, four-wing saltbush, allscale (*Atriplex polycarpa*), Mojave red sage (*Kochia californica*) and greasewood (*Sarcobatus vermiculatus*). Herbs may include alkali heath (*Frankenia salina*), Mediterranean schismus (*Schismus* spp.) or alkali sacaton (*Sporobolus airoides*). The canopy is open to continuous with an herbaceous layer that is sparse to intermittent (Sawyer et al. 2009).

Areas with Bush Seepweed Scrub vegetation are present within 21.74 acres of the Project site northeast of the cemetery. Native plant species found on the Study Area typical of this vegetation community included: occasional four-wing saltbush and a 20 to 30 percent cover of bush seepweed.

#### **4.3.3 Quailbush Scrub**

Quailbush Scrub is found on gentle to steep southeast- and southwest-facing slopes (Sawyer et al. 2009). Soils in this community are often derived from clay. Stands may be found in a variety of settings, from coastal shrublands to alkali sinks and alkali meadows, to desert washes and oases in southern California, and to saline, intermittently flooded wetlands in the Central Valley. This community especially occurs in disturbed areas, including roadsides and fluvial areas with alkaline soils (Sawyer et al. 2009). Quailbush is dominant in the shrub canopy with California sagebrush (*Artemisia californica*), four-wing saltbush, coyote brush (*Baccharis pilularis*), mule fat (*Baccharis salicifolia* subsp. *salicifolia*), salt grass (*Distichlis spicata*), brittlebush (*Encelia californica*), laurel sumac (*Malosma laurina*), arrow weed, lemonadeberry (*Rhus integrifolia*), alkali sacaton, woolly seablite (*Suaeda taxifolia*) and tamarisk species. Emergent trees may be present at low cover, including mousehole tree (*Myoporum laetum*) or honey mesquite (*Prosopis glandulosa*). Shrubs are typically less than 5 meters in height with a canopy that is open to intermittent. The herbaceous layer is variable (Sawyer et al. 2009).

Areas with Quailbush Scrub vegetation are present within 76.28 acres of the Study Area in large areas to the north and east. Native plant species found on the Study Area typical of this vegetation community included: quailbush, bush seepweed, and four-wing saltbush.

#### **4.3.4 Tamarisk Thickets**

Tamarisk Thickets are found along arroyo margins, lake margins, ditches, washes, rivers, and other watercourses (Sawyer et al. 2009). Tamarisk species possess eco-physiological characteristics that make them remarkably formidable as invasive plants. They are long-lived shrubs or trees with extensive and deep root systems. They consume large quantities of water, possibly more than any other woody species in similar habitats, because they can obtain water at very low water potentials and have very high water-use efficiencies. They are highly tolerant of alkaline and saline habitats and can concentrate salts in their leaves (Sawyer et al. 2009). Mediterranean tamarisk (*Tamarix ramosissima*) or another *Tamarix* species is dominant in the shrub canopy. Emergent trees may be present at low cover, including Fremont cottonwood or willow species (*Salix* spp.). Shrubs are typically less than 8 meters in height with a canopy that is continuous or open. The herbaceous layer is sparse (Sawyer et al. 2009).

Areas with Tamarisk Thickets are present within 5.77 acres of the Study Area adjacent to developed earthen channels and roads, in sandy dry areas where the soil did not appear hydric. Non-native species include Mediterranean tamarisk and native species were lacking from within this community.

#### **4.3.5 Agriculture**

Agriculture consists of annual crops, vineyards, orchards, dairies, and stockyards (Gray and Bramlet 1992). The agricultural lands on the Study Area are currently void of vegetation. Agriculture areas account for approximately 109.30 acres of the Study Area.

#### **4.3.6 Disturbed**

Disturbed areas are those areas that are either devoid of vegetation (cleared or graded) or those areas that have a high percentage of non-native weedy species (i.e., greater than 25 percent of the species cover).

Disturbed Areas are present on the Study Area within a strip of mowed land mostly void of living vegetation. Plant species found on the Study Area included quailbush. There are 34.30 acres of Disturbed land within the Study Area.

#### **4.3.7 Bare Ground**

Bare Ground (BG) areas are generally devoid of vegetation, but do not contain any form of desert pavement or former infrastructure. These areas are typically associated with areas that have been previously cleared by earth-moving machinery, are dirt access roads, and/or consist of naturally occurring areas devoid of vegetation. Compared to Developed areas, BG has higher water permeability and higher fossorial rodent habitat potential. Approximately 32.60 acres of BG is present in the Study Area, primarily along dirt roads.

#### **4.3.8 Developed (Earthen Irrigation Channel and Concrete Structure)**

Developed (DV) areas are those where various forms of pavement or man-made earthen structures alter the soil surface. This surface is recorded as separate from bare ground due to the erosional, use, and hydric properties associated with the feature. Due to the lack of permeability or intentionally restrictive design, these areas channel water run-off and can result in unique erosional management considerations.

Developed areas onsite with Earthen Irrigation Channels are located within 4.04 acres of Lots "A", 2, 4, 7, 8, and 9 (Figure 4), with plant species including: salt grass, giant reed (*Arundo donax*), annual beard-grass (*Polypogon monspelinensis*), tamarisk species, and alkali heliotrope (*Heliotropium curassavicum*). Developed areas onsite with Cement Structures such as cement v-ditches and the Memory Gardens Cemetery with scattered ornamental species are located within 8.55 acres of Lots "A", 1, 2, 3, 4, 5, and 9 (Figure 4). Approximately 12.59 acres total of DV area is present in the Proposed Project.

### **4.4 SPECIAL STATUS SPECIES**

The following information is a list of abbreviations used to help determine the significance of biological special status resources potentially occurring within the Study Area.

#### **CNPS California Rare Plant Rank (CRPR)**

- 1A = Plants presumed extinct in California.
- 1B = Plants rare and endangered in California and throughout their range.
- 2 = Plants rare, threatened or endangered in California but more common elsewhere in their range.
- 2A = Plants presumed extirpated in California, but more common elsewhere.
- 3 = Plants about which we need more information, a review list.
- 4 = Plants of limited distribution; a watch list.

#### **CRPR Extensions**

- 0.1 = Seriously endangered in California (greater than 80 percent of occurrences threatened/high degree and immediacy of threat).
- 0.2 = Fairly endangered in California (20 to 80 percent occurrences threatened).
- 0.3 = Not very endangered in California (less than 20 percent of occurrences threatened).



The following information was used to determine the significance of biological resources potentially occurring within the Study Area. The criteria used to evaluate the potential for special status species to occur within the Study Area are outlined in Table 1.

**Table 1. Criteria for Evaluating Special status Species Potential for Occurrence (PFO)**

PFO	CRITERIA
<b>Absent:</b>	Species is restricted to habitats or environmental conditions that do not occur within the Study Area. Additionally, if the survey was conducted within the blooming period of the species and appropriate habitat was observed in the surrounding area but the species was not observed within the Proposed Project impact area it was considered absent.
<b>Low:</b>	Historical records for this species do not exist within the immediate vicinity (approximately 5 miles) of the Study Area, and/or habitats or environmental conditions needed to support the species are of poor quality.
<b>Moderate:</b>	Either a historical record exists of the species within the immediate vicinity of the Project site (approximately 3 miles) and marginal habitat exists on the Study Area, or the habitat requirements or environmental conditions associated with the species occur within the Study Area, but no historical records exist within 5 miles of the Project site.
<b>High:</b>	Both a historical record exists of the species within the Study Area or its immediate vicinity (approximately 1 mile), and the habitat requirements and environmental conditions associated with the species occur within the Study Area.
<b>Present:</b>	Species was detected within the Study Area at the time of the survey.

\* PFO: Potential for Occurrence

#### **4.4.1 Special status Plants**

Factors used to determine the potential for occurrence included the quality of habitat, elevation, and the results of the reconnaissance survey. In addition, the location of prior CNDDDB records of occurrence were used as additional data, but since the CNDDDB is a positive-sighting database, this data was used only in support of the analysis from the previously identified factors.

Current database searches (CDFW 2022 and CNPS 2022) resulted in zero federal- and/or state-listed threatened and/or endangered species documented to occur within 5 miles of the Study Area. However, two CNPS CRPR plants species that may potentially occur within the Mesquite Lake Specific Plan were listed on the MEIR and identified in the CNDDDB. No federal- and/or state-listed threatened and/or endangered or rare plant species were observed during the Chambers Group reconnaissance survey. After a literature review and an assessment of the various habitat types within the Study Area, it was determined that one species is considered absent, and one species has a low potential to occur within the Study Area. Factors used to determine potential for occurrence included the quality of habitat and the location of prior CNDDDB and MEIR records of occurrence.



The analysis of the MEIR records, CNDDDB search, and field survey resulted in one species considered to be **absent** on the Study Area:

- sand food (*Pholisma sonorae*) – CRPR 1B.2

Although observation records for this species occur within 5 miles of the Study Area and arrow weed was observed on site, which is one of the host species, sand food is considered **absent** from the Study Area as the species is restricted to habitats or environmental conditions that do not occur within the Study Area.

The analysis of the MEIR records, CNDDDB search, and field survey resulted in one species with a **low** potential to occur on the Study Area:

- Abram’s spurge (*Chamaesyce abramsiana*) – CRPR 2B.2

Historic records indicate one observation of Abram’s spurge documented approximately 4 miles north of the Study Area (CDFW 2022). Although observation records for this species occur within 5 miles of the Study Area, Abram’s spurge has a **low** potential for occurrence in the Study Area as habitats or environmental conditions needed to support this species are of poor quality.

#### 4.4.2 Special Status Wildlife

A current database search (CNDDDB 2022) resulted in a list of three federal- and/or state-listed endangered or threatened, SSC, or otherwise special status wildlife species that may potentially occur within the Study Area (Appendix A Figure 6). An additional seven federal- and/or state-listed endangered or threatened, Species of Concern, or otherwise special status wildlife species that may potentially occur within the Mesquite Lake Specific Plan were listed on the MEIR. After a literature review and the assessment of the various habitat types within the Study Area, it was determined that seven species had a low potential to occur, one species had a moderate potential to occur, one species has a high potential to occur, and one was determined to be present, within the Study Area. Factors used to determine potential for occurrence included the quality of habitat and the location of prior CNDDDB and MEIR records of occurrence.

The analysis of the MEIR records, CNDDDB search, and field survey resulted in one species considered **absent** since habitat and environmental conditions do not exist on the Study Area:

- Colorado River toad (*Bufo alvarius*) – SSC

The analysis of the MEIR records, CNDDDB search, and field survey resulted in five species with a **low** potential to occur on the Study Area since habitat is of poor quality and historical records of these species do not exist within 5 miles of the site:

- crissal thrasher (*Toxostoma crissale*) – SSC
- ferruginous hawk (*Buteo regalis*) – WL
- flat-tailed horned lizard (*Phrynosoma mcallii*) – SSC
- prairie falcon (*Falco mexicanus*) – WL, USFWS BCC
- western yellow bat (*Lasirus xanthinus*) – SSC
- Yuma clapper rail (*Rallus longirostris yumanensis*) – FE, ST

The analysis of the MEIR records, CNDDDB search, and field survey resulted in one species, mountain plover, with a **moderate** potential to occur on the Study Area as described below:

**mountain plover - SSC**

The mountain plover (wintering) is listed as a California Species of Special Concern. This species breeds from the prairie and sagebrush country of north-central Montana, eastern Wyoming, and the area around southeastern Colorado. It winters from central California along the southern border southward to northern Mexico (Udvardy 1977). The mountain plover is a relatively nondescript shorebird with a short tail, long legs, plain brown plumage above, and whiter plumage below. Males develop a black patch on the forehead during the breeding season. This species is sometimes confused with the American golden plover, but unlike the American golden plover, the belly and under-wing is a clean, white color and the legs are pale. Breeding habitats include semi-arid plains, grasslands, and plateaus. Mountain plovers often use prairie dog mounds as nest sites. Common wintering habitats consist of dry, barren ground, smooth dirt fields, agricultural fields, and shortgrass prairies. This species tends to form small flocks in the winter. It is one of the few shorebird species that prefers habitats away from water. It is an insectivore that eats flies, beetles, grasshoppers, crickets, and other insects. Populations are in decline due to overgrazing practices and are linked to declining prairie dog populations. The continued loss and alteration of habitats on breeding and wintering grounds are the primary threats to the mountain plover. The Proposed Project area contains suitable habitat for this species, no historical records of this species occur within 5 miles of the site, and no individuals were observed during the survey. Therefore, this species has a moderate potential to occur within the Study Area. This species was not observed during the field survey effort.

The analysis of the MEIR records, CNDDDB search, and field survey resulted in one species, San Diego black-tailed jackrabbit, with a **high** potential to occur on the Study Area.

**San Diego black-tailed jackrabbit - SSC**

The San Diego black-tailed jackrabbit (*Lepus californicus bennettii*) is listed as a California Species of Special Concern. It is found on the coastal slope from Kern County, California south into Baja California, Mexico between sea level and approximately 3,000 feet amsl. It occurs in a variety of habitats, but prefers intermediate canopy stages of shrub habitats, grasslands, and open shrub, along herbaceous and tree edges within coastal sage scrub habitats in southern California. It also occurs on agricultural lands. This species does not typically burrow but sits in depressions called forms at the bases of shrubs by day (Howard 1995). No nest structure is typically built by this species. The Proposed Project area contains suitable habitat for this species, this species was detected in open bush seepweed-iodine bush scrub adjacent to the Union Pacific Railroad on the western side of the Specific Plan during the MEIR site assessment, and no individuals were observed during the survey. Therefore, this species has a high potential to occur within the Study Area. This species was not observed during the field survey effort.

One species, burrowing owl, was observed during the reconnaissance survey (Appendix A Figure 7) and is therefore considered **present** within the Study Area.

#### **burrowing owl – SSC**

The burrowing owl (*Athene cunicularia*) is a California Species of Special Concern. It is broadly distributed across the western United States, with populations in Florida and Central and South America. The burrowing owl breeds in open plains from western Canada and the western United States, Mexico through Central America and into South America to Argentina (Klute 2003). This species inhabits dry, open, native or non-native grasslands, deserts, and other arid environments with low-growing and low-density vegetation (Ehrlich 1988). It may occupy golf courses, cemeteries, road rights-of way, airstrips, abandoned buildings, irrigation ditches, and vacant lots with holes or cracks suitable for use as burrows (TLMA 2006). Burrowing owls typically use burrows made by mammals such as California ground squirrels (*Spermophilus beecheyi*), foxes, or badgers (Trulio 1997). When burrows are scarce, the burrowing owl may use man-made structures such as openings beneath cement or asphalt pavement, pipes, culverts, and nest boxes (TLMA 2006). Burrowing owls often are found within, under, or in close proximity to man-made structures. Prey sources for this species include small rodents; arthropods such as spiders, crickets, centipedes, and grasshoppers; smaller birds; amphibians; reptiles; and carrion. Threats to the burrowing owl include loss of nesting burrows, habitat loss, and mortality from motor vehicles. At least sixteen burrowing owls and burrowing owl sign were observed in the southwest portion of the Study Area, along the edges of the concrete-lined irrigation canal (Dahlia Lateral 8). Based on the preliminary design, no impacts to this portion of the canal are anticipated (temporary impacts to Dahlia Lateral 8 are proposed in the southeast corner of the Study Area).

#### **4.5 GENERAL PLANTS**

A total of 12 plant species were observed during the survey. Plant species observed or detected during the site survey were representative of the existing Study Area conditions. No special status plant species were observed during the survey effort. A complete list of plants observed is provided in Appendix C.

#### **4.6 GENERAL WILDLIFE**

A total of nineteen wildlife species were observed during the survey. Wildlife species observed or detected during the site survey were characteristic of the existing Study Area conditions. A complete list of wildlife observed is provided in Appendix D.

#### **4.7 POTENTIAL JURISDICTIONAL WATERS AND WETLANDS**

The results of the database review and jurisdictional waters and wetland delineation are found below.

##### **4.7.1 Jurisdictional Waters**

The Study Area is located within the Salton Sea Watershed and Alamo River Watershed, within the USACE Hydrological Unit Code (HUC) 12: 181002040801 – Town of El Centro Sub-Watershed. This sub-watershed contains an area of approximately 158 square miles (CWIP 2022). Many agricultural drainages and canals within this sub-watershed connect to the Alamo River and flow northward towards the Salton Sea. The

Alamo River originates approximately 2 miles south of the U.S. border with Mexico, flows northward across the border for approximately 50 miles until it terminates into the Salton Sea.

According to the NWI and NHD databases, two streams (agricultural drainages) exist within the northern and southern boundaries of the Study Area (Figure 3). The Dahlia Lateral 8 canal (ID-1) enters the Study Area from the southwest corner along Highway 86 and Lydick Loop, flowing east and northeast past the UPRR tracks. Based on the preliminary designs, approximately 850 linear feet of a concrete lined agricultural ditch (Dahlia Lateral 8 canal) may be temporarily impacted in the southeast corner of the Study Area; portions the canal will be pipelined to support the proposed ladder tracks along the southeastern corner of the Study Area. This portion of the canal is concrete-lined (unvegetated) and does not provide suitable habitat for sensitive plant or wildlife species.

The second drainage, Newside Drain (ID-2) enters the northern area of the Study Area on the west side of Highway 86 from Lydick Loop and Highway 86 and directs flow east/northeast to the Newside Drain. A small outlet of approximately 33 linear feet from the proposed drainage basin into the Newside Drain is anticipated. The Project area already has an existing tail water structure that discharges into the Newside Drain No. 1-A.

The Newside Drain continues off site and flows northeastward to the Rose Drain, east to the Rose Outlet, northeastward to the Alamo River, and northward to the Salton Sea. These drainages facilitate water around the site and eventually to the Salton Sea; therefore, these drainages may be considered WoUS subject to potential USACE jurisdiction under Section 404 of the Clean Water Act, waters of the State pursuant to Section 401 of the Clean Water Act and the California Porter-Cologne Water Quality Control Act (California Water Code, Division 7, §13000 et seq.), and subject to potential CDFW jurisdiction under Sections 1600 et seq. of the California Fish and Game Code.

#### **4.8 NON-JURISDICTIONAL WATERS**

Several man-made unvegetated ditches were observed within the Study Area and are mapped as IC-1, IC-2, IC-3 and IC-4 (Figure 5 Jurisdictional Delineation Results map). When a field is irrigated, water is allowed to flow through smaller man-made earthen or concrete-lined ditches (typically referred to as a “head ditch”), which distributes the water evenly across the field. At the opposite, lower elevation side of the field, excess water is collected into another ditch (typically referred to as a “tail ditch”). The ditches present within the Survey Area are both earthen and concrete-lined and are frequently rebuilt when the fields are plowed and disked. These ditches occur primarily along the edges of the agricultural fields and across portions of the fields.

A series of concrete-lined agricultural ditches (IC-1 and IC-2) were located in a north/south configuration through the middle of the site. These unvegetated ditches do not appear to be in operation within the Survey Area. No USFWS NWI data exists for these concrete-lined ditches. A third concrete-lined agricultural ditch (IC-3) is located north and parallel to Dahlia Lateral 8 along the southern boundary of the Study Area. This unvegetated ditch appears to provide irrigation from Dahlia Lateral 8 to the agricultural fields on the Study Area. The agricultural areas within the Study Area will be developed; therefore, the agricultural ditches used to support the area will no longer be in use. These concrete-lined ditches are temporary and removal will not impede flows to jurisdictional waters; therefore, these ditches should not be considered under CDFW, RWQCB, or USACE jurisdiction.

A series of man-made earthen bottom ditches (IC-4) is located in the center of the Study Area. One is positioned north/south for approximately 1,400 feet, connecting to the second at the northern end, and runs east for 1,400 feet and terminates at the unused concrete ditches (IC-1 and IC-2). The east/west portion of the earthen bottom ditch is recognized by the NWI, appearing to be an extension of the ditch along the northern boundary that terminates on site. These earthen bottom ditches support a small agricultural field to the east of the Memory Gardens Cemetery within the Study Area. Although the man-made ditches receive water from agricultural ditches from the west and connect to the Newside Drain to the northeast, these two ditches only support a small agricultural area contained within the Survey Area. If these ditches are removed and no longer in use, water will continue to flow within the existing ditch (ID-2) along the northern boundary of the Project and into the Newside Drain. Therefore, the two earthen bottom ditches are temporary ditches and should not be considered under CDFW, RWQCB, or USACE jurisdiction.

No other potential jurisdictional waters were identified within the Study Area.

No Federal Emergency Management Agency (FEMA) designated flood zones are located within the Study Area.

#### **4.8.1 Wetlands**

Three vegetation communities identified within the Study Area have vegetation that can be found in wetland communities including Bush Seepweed Scrub, Tamarisk Thickets, and Arrow Weed Thickets. Based on the current National Wetland Plant List (NWPL; USACE 2020), bush seepweed (*Suaeda nigra*) is considered a wetland obligate species, tamarisk species are considered facultative, and arrow weed (*Pluchea sericea*) is considered a facultative wetlands species. Based on the results of the field survey, these three communities are not considered wetland communities. Details are provided below.

Five soil pits were dug in the areas mapped as Bush Seepweed Scrub (Figure 5). Two of the soil pits were investigated between the cemetery and the agricultural fields, while three soil pits were investigated north of the central agricultural field in locations where seepage from the non-jurisdictional agricultural ditches had been observed on historical aerial imagery. The entire area where Bush Seepweed Scrub was found looked to have been regularly tilled. Soils within the first six inches of the soil profile (for all soil pits) were identified as friable sandy clay soils with a color of 7.5YR 4/2 (Munsell 2015). Lower sections in the soil profile were very compact, clay loam soils with a color of 7.5YR 6/2 (Munsell 2015). No redoximorphic features were observed in any of the soil pits; thus, no hydric soils exist within the Bush Seepweed Scrub and are therefore not considered a wetland community.

Additional test pits were dug in areas where Arrow Weed Thickets and Tamarisk Thickets were identified. These communities were primarily found in the southeast corner and the northwest area of the Study Area. The same soil profiles with no redoximorphic features were identified in these communities.

In the southeast corner of the Study Area, Tamarisk Thickets were primarily located on raised benches along access roads that are higher in elevation than the agricultural ditches and canals and did not exhibit hydric characteristics. Areas of Arrow Weed Thickets were primarily located outside and adjacent to an irrigation canal (Dahlia Lateral 8 canal). This portion of the canal is concrete-lined and no vegetation was observed emerging from within the canal. No hydric soils were detected in these communities; therefore, the Arrow Weed Thickets and Tamarisk Thickets that will be impacted in the southeastern area of the Study Area are not considered a wetland community.



In the northwestern area of the Study Area (north of Lot 7), sparsely vegetated areas of Arrow Weed Thickets and Tamarisk Thickets were identified along the northern bank of an earthen bottom agricultural ditch (IC-4). The non-jurisdictional ditches are commonly relocated, maintained (removal of vegetation), and/or abandoned to support agricultural practices in the area. The agricultural areas within the Study Area are proposed to be developed; therefore, the agricultural ditches used to support the area will no longer be in use and will not support Arrow Weed Thickets or Tamarisk Thickets. No hydric soils were identified in these communities; therefore, Arrow Weed Thickets and Tamarisk Thickets are not considered wetland communities.

Based on the results of the database analysis and field delineation survey, no wetlands exist within the Study Area.

**SECTION 5.0 – ANALYSIS OF PROJECT EFFECTS**

Anticipated impacts associated with the Proposed Project are detailed below in Table 2, Table 3 and Table 4 below, and in Appendix A Figure 5. Anticipated impacts are based on current and preliminary design; total impacts are anticipated to be less and will be refined once design is finalized.

**Table 2. Summary of Potential Vegetation Community Impacts Associated with Project Related Activities**

<b>Vegetation Impacts</b>	
<b>Permanent Impacts</b>	<b>Acres</b>
Agriculture	96.62
Arrow Weed Thickets	0.54
Bare Ground	27.88
Bush Seepweed Scrub	21.38
Developed/Concrete Infrastructure	2.31
Developed/Earthen Irrigation Channel	2.26
Disturbed	29.98
Quailbrush Scrub	75.08
Tamarisk Thickets	5.45
<b>Total Permanent Impacts</b>	<b>261.50</b>
<b>Temporary Impacts</b>	<b>Acres</b>
Agriculture	12.69
Arrow Weed Thickets	0.15
Bare Ground	1.09
Developed/Concrete Infrastructure	0.34
Disturbed	0.65
Quailbrush Scrub	1.20
Tamarisk Thickets	0.21
<b>Total Temporary Impacts</b>	<b>16.32</b>
<b>Total Cumulative Impacts</b>	<b>277.83</b>

**Table 3. Summary of Potential Jurisdictional Waters Permanent Impacts Associated with Project Related Activities**

Potential Jurisdictional Waters	Location	Length (ft)	Acres
USACE	unvegetated portion of Dhalia Lateral 8 (concrete-lined canal)	939	0.03
	unvegetated portion of Newside Drain (concrete-lined canal)	33	0.01
RWQCB	unvegetated portion of Dhalia Lateral 8 (concrete-lined canal)	939	0.03
	unvegetated portion of Newside Drain (concrete-lined canal)	33	0.01
CDFW	unvegetated portion of Dhalia Lateral 8 (concrete-lined canal)	939	0.11
	unvegetated portion of Newside Drain (concrete-lined canal)	33	0.01
Non-jurisdictional irrigation canals	IC-1, IC-2 and IC-4 (concrete-lined ditch)	6,266	1.68
Non-jurisdictional irrigation canals	IC-3 (earthen bottom ditch)	2,581	0.25

**Table 4. Summary of Potential Jurisdictional Waters Temporary Impacts Associated with Project Related Activities**

Potential Jurisdictional Waters	Location	Length (ft)	Acres
USACE	unvegetated portion of Dhalia Lateral 8 (concrete-lined canal)	343	0.01
RWQCB	unvegetated portion of Dhalia Lateral 8 (concrete-lined canal)	343	0.01
CDFW	unvegetated portion of Dhalia Lateral 8 (concrete-lined canal)	343	0.05
Non-jurisdictional irrigation canals	IC-1, IC-2 and IC-4 (concrete-lined ditch)	0.02	216

### 5.1 ANTICIPATED IMPACTS

Anticipated impacts are based on current and preliminary design; total impacts are anticipated to be less and will be refined once design is finalized. Proposed Project anticipated direct impacts include: the establishment of the industrial roadway that ties into State Route 86, on-site rail system, development of a memorial area to the east of Memory Gardens Cemetery, development of the centralized potable and fire water location, and the construction of the following features: grain elevator, hay export and container depot, produce export, fuel blending/transloading and fueling station, general commodities transloading and warehousing, and the stormwater retention basin.

Based on preliminary design (exact locations of Project features and work areas are not known at this time), impacts to vegetation communities and aquatic resources provided in Table 2, Table 3 and Table 4 represent impacts to the entire Survey Area with the exception of the following:

- Memory Gardens Cemetery
- Dhalia Lateral 8 canal along the southern boundary of the Survey Area (with the exception of the southeast corner for the proposed ladder tracks converting an open canal to a closed canal)
- Newside Drain along the northwestern and northern boundary (with the exception of a proposed outlet from the stormwater retention basin into the Newside Drain).

Temporary and indirect Project impacts are anticipated to occur within the Proposed Project area; and are expected to include diurnal and nocturnal noise, increased lighting, vehicle traffic and dust production. These may be alleviated through the use of proper implementation of mitigation measures detailed below.

Vibrational impacts to fossorial rodents and burrowing owl are anticipated to be higher once the Proposed Project is fully built out than during the site development phase. The most traffic-intensive construction phase of the project is anticipated to generate less trips than when the Proposed Project's features are

operational. Once the Proposed Project features are operational, the staffed operating hours of the site are expected to be between the hours of approximately 0500 and 1900. During those hours the operational site would have an anticipated 56 onsite employees driving primarily along the industrial collector road over two shifts. In addition, a total of 436 ADT from heavy trucks is expected.

Additionally, implementation of the Proposed Project may result in indirect effects to existing wild animals altering land use patterns while Proposed Project features are being developed. These effects are anticipated to be short term and are not anticipated to negatively affect long-term animal land use patterns once the Proposed Project-related features are operational, as the Mesquite Lake Specific Plan area consists of and is surrounded by large contiguous amounts of similar habitat and linkages that would still provide for wildlife movement.

## **5.2 JURISDICTIONAL WATERS AND WETLANDS**

Based on the data collected and analyzed in this jurisdictional delineation, Chambers Group has identified and delineated approximately 0.04 acre of permanent and 0.01 acre of temporary impacts of non-wetland waters of the United States (WoUS) within the overall Study Area that are subject to the potential regulatory authority of the USACE under Section 404 of the Clean Water Act. Since anticipated impacts to the concrete-lined canals are less than 0.1 acre, this Project would require a CWA Section 404 permit but would not require notification to USACE.

Approximately 0.04 acre of permanent and 0.01 acre of temporary impacts of non-wetland waters (concrete-lined canal) of the State within the overall Study Area that are subject to the potential regulatory authority of the RWQCB jurisdiction are regulated under Section 401 of the Clean Water Act. Under Section 401 of the CWA, the RWQCB regulates any activity that requires a federal permit for discharges to a water body. The State Water Board General Order (Order No. WQ 2021-0048-DWQ) is pre-certified for USACE NWP 14 but requires the project to be exempt from CEQA and comply with the size threshold of no more than 0.01 acre and 100 linear feet permanent impact and no more than 0.2 acre and 300 linear feet total impact. This Project does not meet the requirements for the General Order. A 401 Water Quality Certification may be required from the RWQCB for this Project.

Approximately 0.13 acre of permanent and 0.05 acre of temporary impacts to the concrete-lined canals are subject to potential CDFW jurisdiction under Sections 1600 et seq. of the California Fish and Game Code. CDFW regulates impacts or alterations to streambeds, including any obstruction or diversion to the natural flow of a stream, substantial change or use of material from a stream, or a deposit or disposal of any debris into a stream as part of Fish and Game Code Sections 1600-02. A Streambed Alteration Agreement (SAA) may be required from CDFW for this Project.

With the installation of the proposed water detention basin and conversion of open canal to closed canal, no net loss of waters is anticipated for this Project. No native vegetation is associated with the concrete-lined canals; therefore, no restoration of native habitat is proposed. Any temporary impacts to concrete-lined portions of the canal will be restored to its original condition.

## **5.3 MITIGATION MEASURES AND DESIGN CONSIDERATIONS**

In order to minimize potential impacts to sensitive species with the potential to occur within the Study Area, the following mitigation measures should be implemented prior to and during construction activities:



- The construction footprint will be clearly defined with flagging and/or fencing and will be removed upon completion.
- Prior to the start of construction activities, an environmental education program will be provided for all project personnel. The education program will include the following: (1) the potential presence of covered species and their habitats, (2) the requirements and boundaries of the project, (3) the importance of complying with avoidance and minimization measures, (4) environmentally responsible construction practices, (5) identification of sensitive resource areas in the field, and (6) problem reporting and resolution methods.
- Preconstruction surveys will be conducted for the burrowing owl within 30 days of construction in all suitable habitat within the proposed Project Impact Areas.
- If any ground disturbing activities are planned during the burrowing owl nesting season (approximately February 1 through August 31), avoidance measures shall include a no construction buffer zone of a minimum distance of 250 feet, consistent with the Staff Report on Burrowing Owl Mitigation (CDFG, 2012). Compliance shall be maintained with CDFW burrowing owl mitigation guidelines as detailed in the Staff Report on Burrowing Owl Mitigation (CDFG, 2012) or more recent updates, if available.
- If vegetation clearing must occur during the bird breeding season (February 15-August 31), a preconstruction nest survey will be conducted.
- If project activities are proposed to occur during the bird breeding season (February 15-August 31), a qualified biologist shall conduct a preconstruction nesting survey to ensure that no active nests are present within or adjacent to the project areas. If an active nest is observed that may be impacted by project-related activities, avoidance measures shall be implemented to avoid impacting the nest. Avoidance measures include delaying construction within the immediate vicinity of the active nest until the young have fledged or naturally failed, or instituting a buffer around the nest that prohibits construction activities to occur but allows construction to continue outside the buffer. The appropriate avoidance buffer is to be determined by the qualified biologist based on vegetative cover, topography, stage of nest or young development, and species type.
- A qualified biological monitor should conduct an environmental awareness training prior to the start of any construction related activities. Special focus should be made on special status animals that have a PFO and special status habitat located adjacent to the Proposed Project Area.
- A preconstruction sweep for San Diego black-tailed jackrabbit should be conducted before initial construction activities. If a jackrabbit is found, the jackrabbit should be allowed to move out of harm's way.
- Approximately 16 burrowing owls were observed within the southwestern corner of the Survey Area along the banks of concrete lined canals. A focused survey for burrowing owl should be conducted prior to commencement of construction activities, in compliance with the *CDFW Staff Report on Burrowing Owl Mitigation* (March 7, 2012). The surveys will determine the potential effects of the Proposed Project and activities on burrowing owls, and to avoid take in accordance with CDFW Code sections 86, 3503, and 3503.5. The assessment will determine how burrowing owls are utilizing the Project and surrounding area, where the owls are located, and the status of

the owls (i.e., breeding, satellite burrows, etc.). Occupied (breeding) burrows must be avoided during the nesting period, from February 1 through August 31. Occupied burrows during the non-breeding season by migratory or non-migratory residents should also be avoided. Avoidance buffers will be based on the CDFW recommended restricted activity dates and setback distances outlined in the CDFW Staff Report. If non-breeding occupied burrows cannot be avoided, coordination with CDFW will be required to determine if passive relocation is possible. In this event, a Burrowing Owl Exclusion Plan that details a burrowing owl exclusion plan will be required and approved by CDFW before such activities are conducted. Biological monitoring of the owls (prior to, during and after exclusion) will be required in accordance with the CDFW Staff Report recommendations. Mitigation for permanent impacts to nesting, occupied and satellite burrows and associated burrowing owl habitat will be required in accordance with CDFW mitigation requirements. A Burrowing Owl Monitoring and Mitigation Plan, approved by CDFW, will be required prior to initiating ground disturbance activities.

- Take avoidance surveys in accordance with the CDFW Burrowing Owl Staff Report (CDFW 2012) for burrowing owl will be required prior to commencement of construction activities. The survey must be completed no less than 14 days prior to initiating ground disturbance activities.
- Biological monitoring of the burrowing owls will be required during Project construction activities to ensure no impacts to burrowing owl occur. The level of effort and duration of the monitoring will be provided in the Burrowing Owl Monitoring and Mitigation Plan.

#### **General**

The following mitigation measures are proposed that specifically relate the Proposed Project in general:

- Appropriate fugitive dust control measures should be implemented prior to grading activities to minimize impacts to the surrounding areas.
- BMPs should be implemented to prevent new erosional features from developing in any newly contoured areas (including access roads and any access footpaths).

#### **Jurisdictional Waters**

The following mitigation measures are proposed that specifically relate to jurisdictional features located within the Proposed Project in general:

- The construction footprint will be clearly defined with flagging and/or fencing to avoid impacts to jurisdictional waters and will be removed upon completion.
- BMPs including erosion control measures, such as weed-free straw wattles should be in place during the construction near jurisdictional water areas to avoid downstream sedimentation.
- Additional protection measures for the protection of jurisdictional waters and associated mitigation will be identified in any 401/404/1600 permits, if required.

#### **5.4 CONCLUSIONS**

Through the implementation of the above mitigation measures it is expected the Proposed Project will have a less than significant impact on species diversity or richness of the Proposed Project Area or surrounding ecosystem. Wildlife movement corridors may shift slightly due to the development of the site; however, the Proposed Project is within the Mesquite Lake Specific Plan which consists of and is surrounded by large contiguous amounts of similar habitat and linkages that would still provide for wildlife movement.

Due to the presence of a burrowing owl during the reconnaissance survey, burrowing owl and burrowing owl burrow focused survey should be conducted before construction activities commence. Preconstruction surveys should be conducted for San Diego black-tailed jackrabbit.

Two special status plants were identified during the database search; however, habitat quality is not suitable for these species. No special status plants were observed during the reconnaissance survey. Based on the poor quality of habitat found on site, a focused plant survey should not be required. Therefore, with the information available to date, no impacts to special status plant species are anticipated due to Proposed Project related activities.

Approximately 0.04 acre of permanent and 0.01 acre of temporary impacts of non-wetland waters of the United States (WoUS) within the overall Study Area may require a CWA Section 404 permit but would not require notification to USACE.

Approximately 0.04 acre of permanent and 0.01 acre of temporary impacts of non-wetland waters (concrete-lined canal) of the State within the overall Study Area may require a 401 Water Quality Certification from the RWQCB for this Project.

Approximately 0.13 acre of permanent and 0.05 acre of temporary impacts to the concrete-lined canals may require a Streambed Alteration Agreement (SAA) from CDFW for this Project.

## SECTION 6.0 – SUMMARY OF PROJECT IMPACTS AND MITIGATION

### SECTION 7.0 – REFERENCES

- Baldwin, B.G., D.H. Goldman, D.J. Keil, R. Patterson, and T.J. Rosatti, and D.H. Wilken (editors)  
2012 The Jepson Manual: Vascular Plants of California, Second Edition. University of California Press, Berkeley, CA.
- California Department of Fish and Wildlife (CDFW)  
2012 Staff Report on Burrowing Owl Mitigation. National Resources Agency, Department of Fish and Game. March 7, 2012.
- 2022 California Natural Diversity Database (CNDDDB). RareFind Version 5.108.157. Database Query for the *Westmorland West, Westmorland East, Wiest, Brawley NW, Brawley, Alamorio, Seely, El Centro, and Holtville West*, California USGS 7.5 minute quadrangles. Wildlife and Habitat Data Analysis Branch.
- California Native Plant Society Electronic Inventory (CNPSEI)  
2022 Inventory of Rare and Endangered Plants (online edition). Rare Plant Scientific Advisory Committee, California Native Plant Society, Sacramento, California. Accessed August 2022 from <http://www.cnps.org/inventory> for the *Westmorland West, Westmorland East, Wiest, Brawley NW, Brawley, Alamorio, Seely, El Centro, and Holtville West*, California USGS 7.5 minute quadrangles.
- California Water Indicators Portal  
2022 UC Davis website: <https://indicators.ucdavis.edu/cwip/huc/181002040801>, accessed August 2022.
- Cowardin, L.M., V. Carter, F.C. Golet, and E.T. LaRoe.  
1979 Classification of Wetland and Deep Water Habitats of the United States. Performed for Office of Biological Services, Fish and Wildlife Service, U.S. Department of the Interior, Washington, D.C.
- Ehrlich P.R., D.S. Dobkin, and D. Wheye  
1988 The Birder's Handbook; A Field Guide to the Natural History of North American Birds. Simon and Schuster Inc. New York.
- Formation Environmental  
2018 Salton Sea Air Quality Mitigation Program; 2016/2017 Annual Report and Emissions Estimates. Imperial Irrigation District, Imperial County, California.
- Google  
2015 Aerial satellite imagery. Accessed via [www.earth.google.com](http://www.earth.google.com)
- Hickman, J.C. (ed.)  
1993 *The Jepson Manual: Higher Plants of California*. University of California Press, Berkeley, California.

Howard, J.L.

- 1995 *Lepus californicus*. In: Fire Effects Information System. U.S. Department of agriculture, Forest Service, Rocky Mountain Research station, Fire Sciences Laboratory.

Lichvar, R.W., D.L. Banks, W.N. Kirchner, and N.C. Melvin

- 2016 The National Wetland Plant List: 2016 Wetland Ratings. *Phytoneuron* 2016-30: 1-17. Published 28 April 2016.

National Geographic Society.

- 1999 Field guide to birds of North America. 3rd ed. National Geographic Society, Washington, DC.

Steenhof, K.

- 1998 Prairie Falcon (*Falco mexicanus*). In The Birds of North America, No. 346 (A. Poole and F. Gill, eds.). The Birds of North America, Inc., Philadelphia, PA.

United States Army Corps of Engineers (USACE)

- 1987 Corps of Engineers Wetlands Delineation Manual. U.S. Army Corps of Engineers Waterways Experiment Station. Vicksburg, MS.
- 2008 Regional Supplement to the Corps of Engineers Wetland Delineation Manual: Arid West Region (Version 2.0), ed. J. S. Wakeley, R. W. Lichvar, and C. V. Noble. ERDC/EL TR-08-28. Vicksburg, MS: U.S. Army Engineer Research and Development Center.
- 2020 National Wetland Plants List. Website address: [https://wetland-plants.sec.usace.army.mil/nwpl\\_static/data/DOC/lists\\_2020/National/National\\_2020v1.pdf](https://wetland-plants.sec.usace.army.mil/nwpl_static/data/DOC/lists_2020/National/National_2020v1.pdf)

U.S. Department of Agriculture (USDA)

- 2022 Soil Survey Staff, Natural Resources Conservation Service, United States Department of Agriculture. Official Soil Series Descriptions [Online WWW]. Available URL: "https://websoilsurvey.sc.egov.usda.gov/App/WebSoilSurvey.aspx" [Accessed August 2022].

United States Fish and Wildlife Service (USFWS)

- 2022 Wetlands National Inventory Mapper. Available at <http://www.fws.gov/wetlands/Data/Mapper.html> > (Accessed August 2022).

United States Geological Survey (USGS)

- 2018 *Truckhaven* and *Durmid SE* 7.5-minute series topographic quadrangles. United States Department of Interior. Accessed September 2019.

Udvardy, M. D. F.

- 1977 The Audubon Society Field Guide to North American Birds: Western Region. Alfred A. Knopf, Inc., New York (distributed by Random House, New York).



**SECTION 8.0 – LIST OF PREPARERS**

**Preparers:**

Erik Olmos – Project Biologist, report author

Jessica Calvillo – Biologist, report author

Phillip Carlos – GIS Analyst, map designer

**APPENDIX A – SITE FIGURES**

EEC ORIGINAL PKG



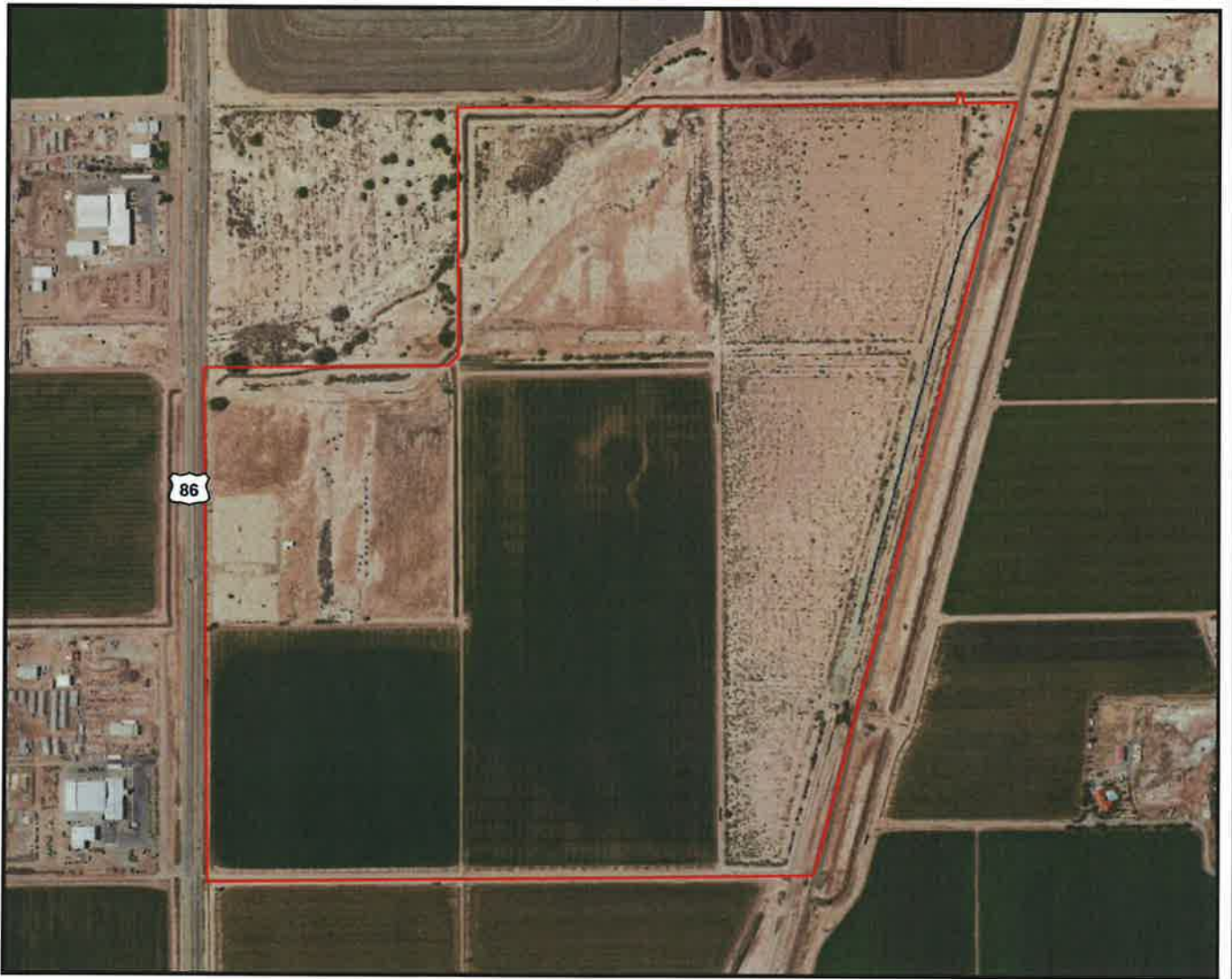

Project Location

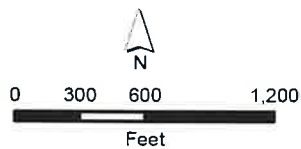

**Figure 1**  
Green Valley Logistics Center  
Project Location and Vicinity



Project Location

**Soils**

- |  |   |
|--|---|
| <ul style="list-style-type: none"> <li><span style="display: inline-block; width: 15px; height: 10px; background-color: #c0504d; margin-right: 5px;"></span> 110 - Holtville silty clay, wet</li> <li><span style="display: inline-block; width: 15px; height: 10px; background-color: #ffff00; margin-right: 5px;"></span> 114 - Imperial silty clay, wet</li> <li><span style="display: inline-block; width: 15px; height: 10px; background-color: #d2b48c; margin-right: 5px;"></span> 115 - Imperial-Glenbar silty clay loams, wet, 0 to 2 percent slopes</li> </ul> | <ul style="list-style-type: none"> <li><span style="display: inline-block; width: 15px; height: 10px; background-color: #ffff00; margin-right: 5px;"></span> 116 - Imperial-Glenbar silty clay loams, 2 to 5 percent slopes</li> <li><span style="display: inline-block; width: 15px; height: 10px; background-color: #800000; margin-right: 5px;"></span> 122 - Meloland very fine sandy loam, wet</li> <li><span style="display: inline-block; width: 15px; height: 10px; background-color: #808000; margin-right: 5px;"></span> 144 - Vint and Indio very fine sandy loams, wet</li> </ul> |
|--|---|

**Figure 2**  
Green Valley Logistics Center  
Soils



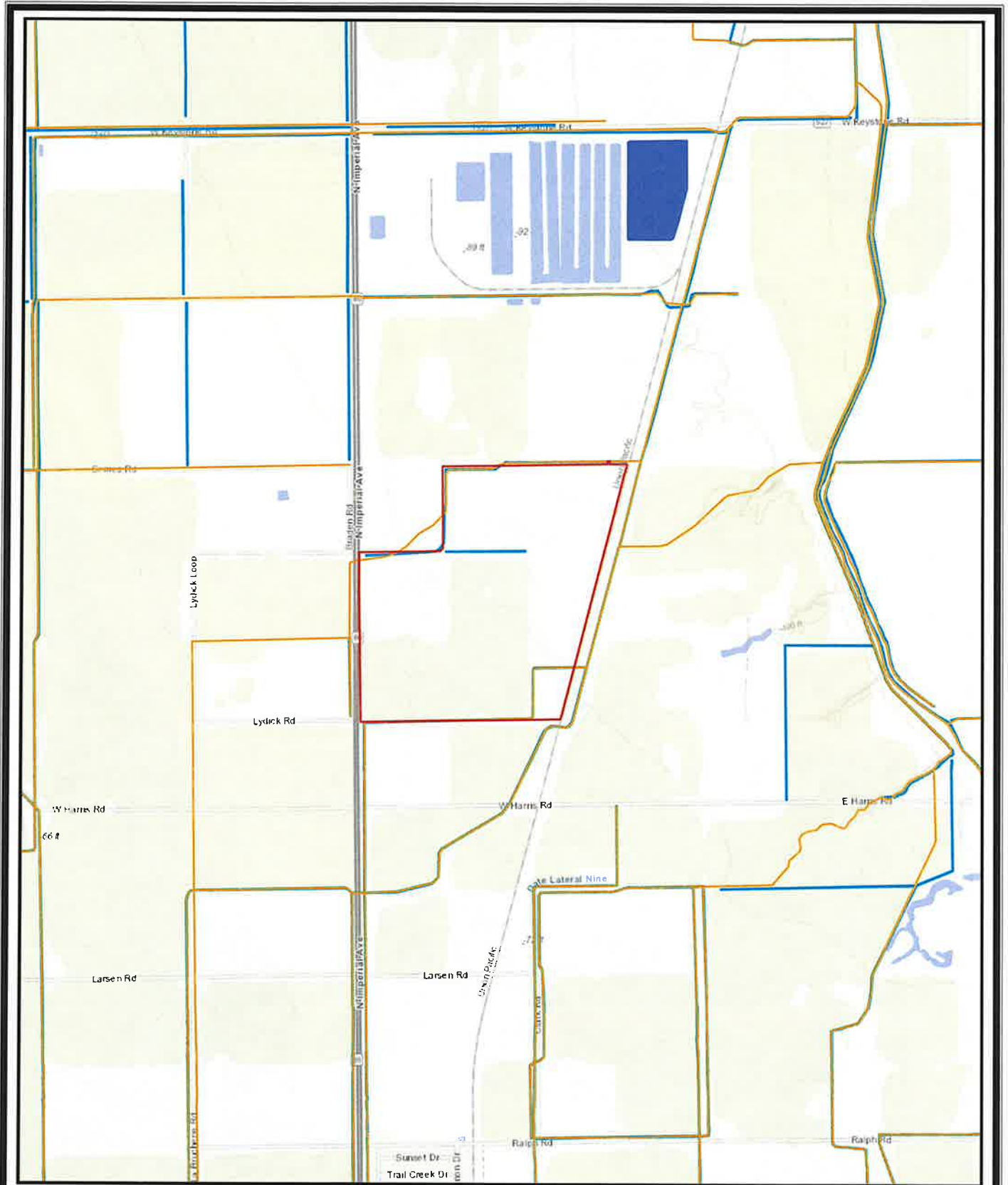

- Project Location
- NHD**
- Canal/Ditch
- NWI**
- Freshwater Pond
- Riverine
- Lake

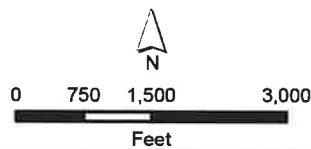

**Figure 3**  
Green Valley Logistics Center  
NWI and NHD





- Project Location
- Vegetation Communities**
- |                |                                      |   |
|----------------|--------------------------------------|---|
| 1. Agriculture | 4. Developed/Concrete Infrastructure | 7. Arrow Weed Thickets                  |
| 2. Disturbed   | 5. Quailbrush Scrub                  | 8. Developed/Earthen Irrigation Channel |
| 3. Bare Ground | 6. Tamarisk Thickets                 | 9. Bush Seepweed Scrub                  |

**Figure 4**  
Green Valley Logistics Center  
Vegetation Communities



- Project Location
  - Soil Pit
  - Berm Drainage
  - Storm Water Swale
- | Jurisdictional Waters   | Non-Jurisdictional Ditches  |
|---|---|
| <span style="border-bottom: 1px solid blue; width: 20px; margin-right: 5px;"></span> Concrete Lined Irrigation Canal  | <span style="border-bottom: 1px solid orange; width: 20px; margin-right: 5px;"></span> Earthen Bottom Ditch |
| <span style="border-bottom: 1px solid green; width: 20px; margin-right: 5px;"></span> Earthen Bottom Irrigation Canal | <span style="border-bottom: 1px solid brown; width: 20px; margin-right: 5px;"></span> Concrete Lined Ditch  |

**Figure 5**  
Green Valley Logistics Center  
Jurisdictional Delineation Results



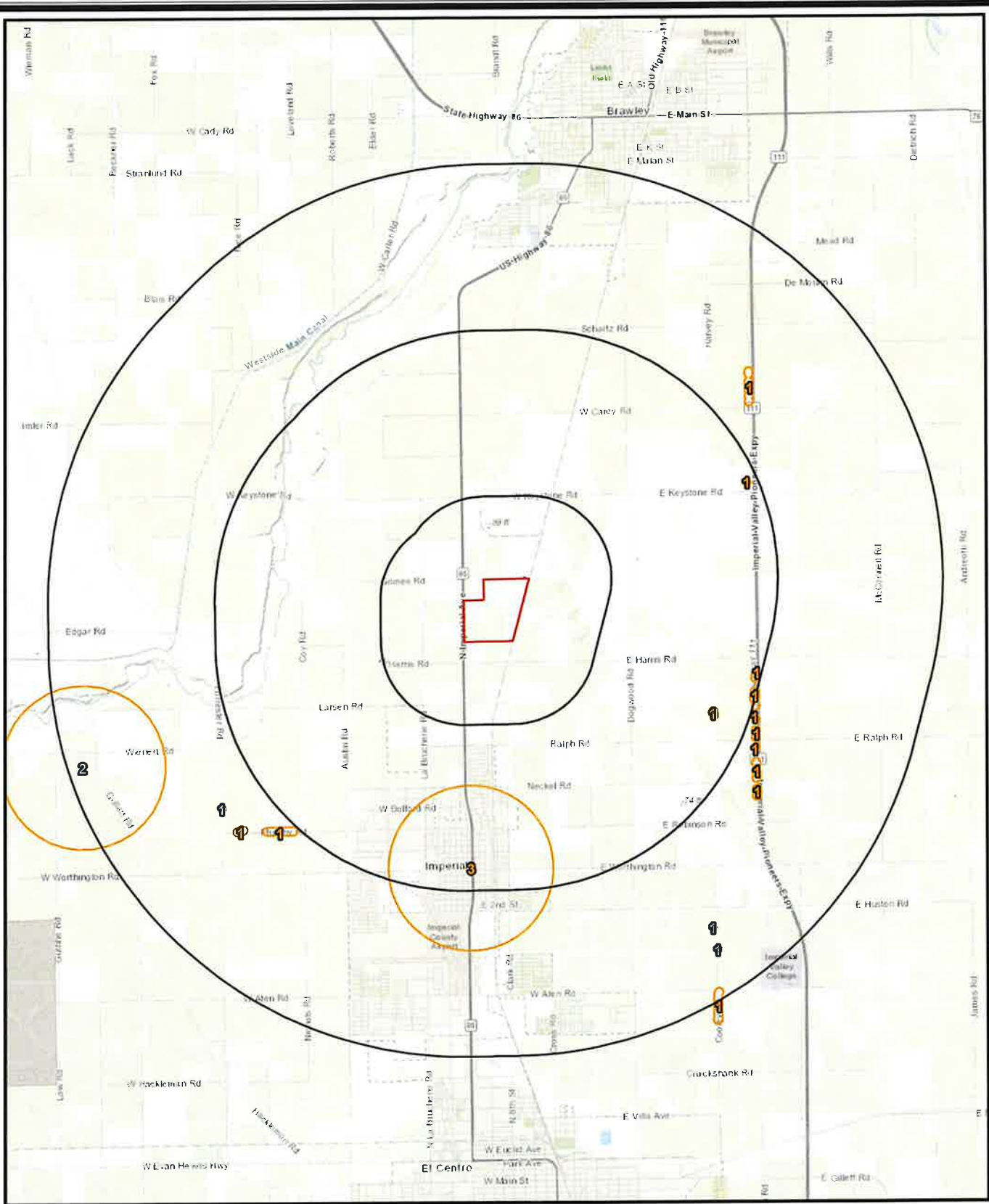

- Project Location
- CNDBB Occurrences**
- Animals
- 1. burrowing owl
- 2. flat-tailed horned lizard
- 3. western yellow bat

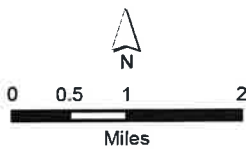

**Figure 6**  
Green Valley Logistics Center  
CNDBB Occurrences

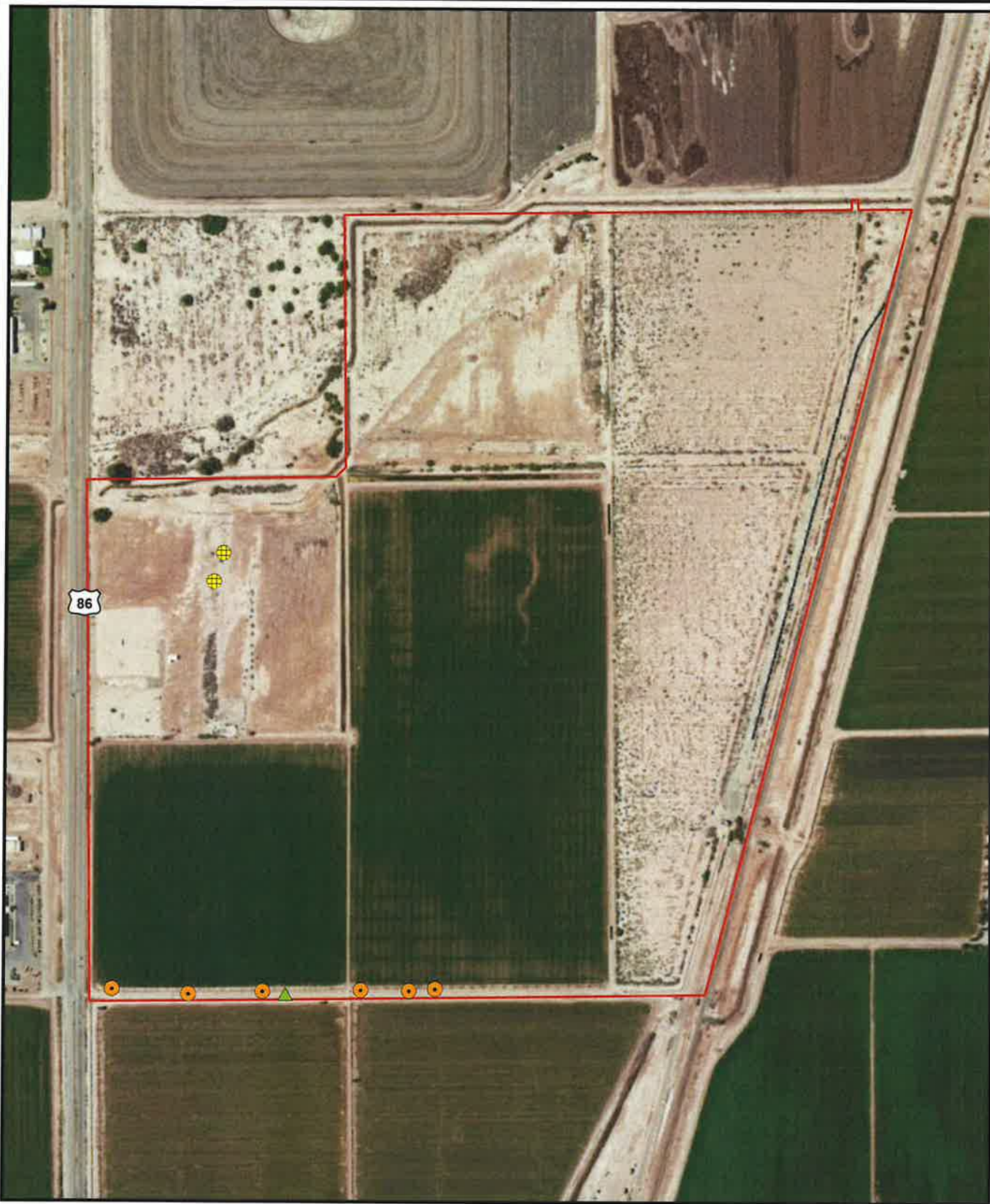

Project Location

**Nest Locations**

⊗ Lesser Nighthawk

**Species Observations**

○ Burrowing Owl

▲ Burrowing Owl Sign

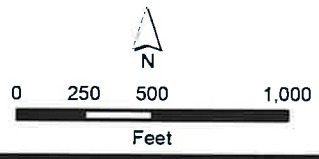

**Figure 7**  
Green Valley Logistics Center  
Wildlife Observations

**APPENDIX B – SITE PHOTOGRAPHS**

EEC ORIGINAL PKG





**APPENDIX B – SITE PHOTOGRAPHS**



**Photograph 1a** is located at the southwest corner of the Project site at the corner of Dahlia Lateral Eight and Imperial Avenue, facing east. Photograph depicts disturbed agricultural land.



**Photograph 1b** is located at the southwest corner of the Project site at the corner of Dahlia Lateral Eight and Imperial Avenue, facing north. Photograph depicts a stormwater swale paralleling the Project site.



**Photograph 2** is located at the southern boundary Project site at the corner of Dahlia Lateral Eight, facing northeast. Photograph depicts erosion along edge of a concrete-lined irrigation channel that could potentially become burrowing owl burrows.



**Photograph 3a** is located at the southern boundary Project site along Dahlia Lateral Eight, facing west. Photograph depicts parallel concrete-lined irrigation channels.



**Photograph 3b** is located at the southern boundary Project site along Dahlia Lateral Eight, facing northwest. Photograph depicts disturbed agricultural land.



**Photograph 3c** is located at the southern boundary Project site along Dahlia Lateral Eight, facing northeast. Photograph depicts disturbed land and Quailbush Scrub.



**Photograph 4** is located at the southern boundary of the Project north of Dahlia Lateral Eight, facing north. Photograph depicts disturbed land and Quailbush Scrub.



**Photograph 5** is located at the southern boundary of the Project north of Dahlia Lateral Eight and near Photograph 3, facing northwest. Photograph depicts disturbed agricultural land and an unused concrete-lined irrigation channel.





**Photograph 6** is located near the southern boundary of the Project north of Dahlia Lateral Eight and near Photograph 5, facing southeast. Photograph depicts an unused concrete-lined irrigation channel, with Quailbush Scrub in the background.



**Photograph 7** is located near the eastern boundary of the Project, facing northeast. Photograph depicts disturbed Quailbush Scrub, and Tamarisk Thicket within a bermed drainage.



**Photograph 8** is located near the eastern boundary of the Project, facing northeast. Photograph depicts Tamarisk Thicket within a bermed drainage.



**Photograph 9** is located near the eastern boundary of the Project and east of Photograph 8, facing west. Photograph depicts disturbed agricultural land and Quailbush Scrub.



**Photograph 10** is located near the eastern boundary of the Project and north of Photograph 8, facing south. Photograph depicts disturbed Quailbush Scrub, Tamarisk Thicket, and a concrete-lined irrigation channel.



**Photograph 11** is located near the eastern boundary of the Project and north of Photograph 10, facing northwest. Photograph depicts Quailbush Scrub, and the existing rail line.





**Photograph 12a** is located near the eastern boundary of the Project and north of Photograph 11, facing west. Photograph depicts disturbed Quailbush Scrub.



**Photograph 12b** is located near the eastern boundary of the Project west of the existing rail line and north of Photograph 11, facing north. Photograph depicts disturbed Quailbush Scrub.



**Photograph 13a** is located near the eastern boundary of the Project west of the existing rail line and north of Photograph 12, facing southwest. Photograph depicts disturbed Quailbush Scrub.



**Photograph 13b** is located near the eastern boundary of the Project west of the existing rail line and north of Photograph 12, facing northwest. Photograph depicts disturbed Quailbush Scrub.



**Photograph 14** is located near the eastern boundary of the Project west of the existing rail line and north of Photographs 13, facing northeast. Photograph depicts disturbed Quailbush Scrub and the existing rail line.



**Photograph 15a** is located near the at the northeastern corner of the Project west of the existing rail line and south of Newside Drain No. 1-A, facing southeast. Photograph depicts disturbed land and Tamarisk Thicket.





**Photograph 15b** is located near the northeastern corner of the Project west of the existing rail line, facing southwest. Photograph depicts Quailbush Scrub.



**Photograph 16** is located near the northeastern corner of the Project, facing west. Photograph depicts the Newside Drain No. 1-A.



**Photograph 17** is located along the northern boundary of the Project, facing southwest. Photograph depicts an apiary on bare ground between Quailbush Scrub.



**Photograph 18** is located along the northern boundary of the Project, facing south. Photograph depicts Quailbush Scrub and an unused concrete-lined irrigation channel.



**Photograph 19** is located in the interior portion of the Project site near the northeastern corner of the Project site, facing southwest. Photograph depicts disturbed land, Quailbush Scrub, and the lack of connectivity between the two unused concrete-lined irrigation channels.



**Photograph 20** is located in the interior portion of the Project site near the northeastern corner of the Project site, facing west. Photograph depicts agricultural land, an earthen irrigation channel, Tamarisk Thicket, and Quailbush Scrub.





**Photograph 21a** is located along the northern boundary of the Project, facing northwest. Photograph depicts the Newside Drain No. 1-A.



**Photograph 21b** is located along the northern boundary of the Project west of existing rail line facing west. Photograph depicts disturbed land and the Newside Drain No. 1-A.



**Photograph 22** is located along the northern boundary of the Project south of Grimes Road, facing southeast. Photograph depicts vegetation stockpiles in disturbed land.





**Photograph 23** is located along the northwest boundary of the Project adjacent to Grimes Road, facing northeast. Photograph depicts bare ground with Bush Seepweed Scrub in the background.



**Photograph 24** is located along the northwest boundary of the Project adjacent to Grimes Road facing east. Photograph depicts agricultural land, Arrow Weed Thicket, and an earthen irrigation channel.



**Photograph 25** is located along the northwestern boundary of the Project south of Grimes Road, facing southeast. Photograph depicts agricultural land.



**Photograph 26** is located along the northwestern boundary of the Project south of Grimes Road west of Photograph 28, facing southeast. Photograph depicts agricultural land and an earthen irrigation channel.



**Photograph 27** is located near the northwestern boundary of the Project south of Grimes Road southwest of Photograph 29, facing southeast. Photograph depicts disturbed land.



**Photograph 28** is located near the northwestern boundary of the Project site at the corner of Grimes Road and Imperial Avenue, south of Grimes Road, facing south. Photograph depicts disturbed land and vegetation stockpiles.





**Photograph 29** is located near the northwestern boundary of the Project at the corner of Grimes Road and Imperial Avenue, south of Grimes Road, facing south. Photograph depicts disturbed land.



**Photograph 30** is located in the interior portion of west side of the Project site parallel to Imperial Avenue, facing south. Photograph depicts disturbed land and Tamarisk Thicket.



**Photograph 31.** Potential burrowing owl sign (feather) found along the southern boundary of the Project site at Dahlia Lateral Eight.



**Photograph 32.**  
Potential burrowing owl sign (pellet) found along the southern boundary of the Project site at Dahlia Lateral Eight.



**Photograph 33.**  
Potential burrowing owl sign (burrow) found along the southern boundary of the Project site at Dahlia Lateral Eight.



**Photograph 34.**  
Burrowing owl observed along the southern boundary of the Project site, beside a Dahlia Lateral Eight gate structure.

**APPENDIX C – PLANT SPECIES LIST**

EEC ORIGINAL PKG





## APPENDIX C – PLANT SPECIES LIST

Scientific Name	Common Name
<b>ANGIOSPERMS (EUDICOTS)</b>	
<b>ASTERACEAE</b>	<b>SUNFLOWER FAMILY</b>
<i>Helianthus annuus</i>	common sunflower
<i>Pluchea sericea</i>	arrow weed
<b>BORAGINACEAE</b>	<b>BORAGE FAMILY</b>
<i>Heliotropium curassavicum</i> var. <i>oculatum</i>	alkali heliotrope
<b>CHENOPODIACEAE</b>	<b>GOOSEFOOT FAMILY</b>
<i>Atriplex canescens</i>	four-wing saltbush
<i>Atriplex lentiformis</i>	quailbush
<i>Suaeda nigra</i>	bush seepweed
<b>MALVACEAE</b>	<b>MALLOW FAMILY</b>
<i>Malvella leprosa</i>	alkali-mallow
<b>TAMARICACEAE</b>	<b>TAMARISK FAMILY</b>
<i>Tamarix ramosissima</i> *	Mediterranean tamarisk
<b>ANGIOSPERMS (MONOCOTS)</b>	
<b>POACEAE</b>	<b>GRASS FAMILY</b>
<i>Arundo donax</i> *	giant reed
<i>Distichlis spicata</i>	saltgrass
<i>Leptochloa fusca</i> subsp. <i>fascicularis</i>	bearded sprangletop
<i>Polypogon monspeliensis</i> *	annual beard grass
*Non-Native Species	

**APPENDIX D -- WILDLIFE SPECIES LIST**

EEC ORIGINAL PKG



**APPENDIX D – WILDLIFE SPECIES LIST**

Scientific Name	Common Name
<b>CLASS INSECTA</b>	<b>INSECTS</b>
<b>HESPERIIDAE</b>	<b>TRUE SKIPPERS</b>
<i>Lerodea eufala</i>	Eufala skipper
<b>CLASS AVES</b>	<b>BIRDS</b>
<b>ARDEIDAE</b>	<b>HERONS, BITTERNs</b>
<i>Ardea alba</i>	great egret
<b>THRESKIORNITHIDAE</b>	<b>IBISES</b>
<i>Plegadis chihi</i>	white-faced ibis
<b>ANATIDAE</b>	<b>DUCKs, GEESE, SWANS</b>
<i>Anas platyrhynchos</i>	Mallard
<b>ODONTOPHORIDAE</b>	<b>NEW WORLD QUAIL</b>
<i>Callipepla gambelii</i>	Gambel's quail
<b>CHARADRIIDAE</b>	<b>PLOVERS</b>
<i>Charadrius vociferus</i>	killdeer
<b>LARIDAE</b>	<b>SKUAs, GULLs, TERNS, SKIMMERS</b>
<i>Larus californicus</i>	California gull
<b>COLUMBIDAE</b>	<b>PIGEONS &amp; DOVES</b>
<i>Zenaida macroura</i>	mourning dove
<b>CUCULIDAE</b>	<b>CUCKOOS &amp; ROADRUNNERS</b>
<i>Geococcyx californianus</i>	greater roadrunner
<b>STRIGIDAE</b>	<b>TRUE OWLS</b>
<i>Athene cunicularia</i>	burrowing owl
<b>CAPRIMULGIDAE</b>	<b>NIGHTHAWKS</b>
<i>Chordeiles acutipennis</i>	lesser nighthawk
<b>REMIZIDAE</b>	<b>VERDINS</b>
<i>Auriparus flaviceps</i>	Verdin
<b>STURNIDAE</b>	<b>STARLINGS</b>
<i>Sturnus vulgaris</i>	European starling
<b>ICTERIDAE</b>	<b>BLACKBIRDS</b>
<i>Agelaius phoeniceus</i>	red-winged blackbird
<i>Euphagus cyanocephalus</i>	Brewer's blackbird
<i>Sturnella neglecta</i>	western meadowlark
<i>Quiscalus mexicanus</i>	great-tailed grackle
<b>EMBERIZIDAE</b>	<b>EMBERIZIDS</b>
<i>Melospiza crissalis</i>	California towhee
<b>CLASS MAMMALIA</b>	<b>MAMMALS</b>
<b>LEPORIDAE</b>	<b>HARES &amp; RABBITS</b>
<i>Sylvilagus audubonii</i>	desert cottontail

**SB 610 - Water Supply Assessment**

**For**

**Green Valley Logistics Center Project**

**July 2023**

**Prepared For:**

**Imperial County Planning and Development Services Department**

**801 Main Street**

**El Centro, California 92243**

(This page Intentionally left blank)



# Green Valley Logistics Center Project

## Contents

---

- To properly update automated fields and TOC – Highlight (Select) entire WSA document and Select F9 and then select update entire table for the TOC, list of Figures and list of Tables, when prompted.

PURPOSE OF WATER SUPPLY ASSESSMENT.....	7
Project Determination According to SB 610 - Water Supply Assessment .....	7
EXECUTIVE SUMMARY .....	9
PROJECT DESCRIPTION.....	11
Description of IID Service Area .....	26
Climate Factors .....	26
Imperial Valley Historic and Future Land and Water Uses.....	29
Imperial Integrated Regional Water Management Plan (October 2012).....	30
IID Interim Water Supply Policy for Non-Agricultural Projects (September 2009) .....	33
IID Temporary Land Conversion Following Policy (May 2012).....	34
IMPERIAL IRRIGATION DISTRICT’S WATER RIGHTS .....	35
California Law .....	35
Law of the River .....	35
IMPERIAL IRRIGATION DISTRICT WATER SUPPLY AND DEMAND .....	45
WATER AVAILABILITY – NORMAL YEAR .....	45
EXPECTED WATER AVAILABILITY – SINGLE DRY AND MULTIPLE DRY YEARS.....	48
Water Management under a Suspended Inadvertant Overrun Payback Policy (IOPP).....	48
Equitable Distribution Plan (EDP) History .....	51
Projected Water Supplies .....	52
PROJECT WATER AVAILABILITY FOR A 54-YEAR PERIOD TO MEET PROJECTED DEMANDS.....	53
EXPECTED WATER DEMANDS FOR THE PROPOSED PROJECT.....	56
IID’S ABILITY TO MEET DEMANDS WITH WATER SUPPLY .....	58
Expanding Water Supply Portfolio.....	61
IID Near Term Water Supply Projections.....	63
IMPERIAL COUNTY PLANNING AND DEVELOPMENTAL SERVICES (LEAD AGENCY) FINDINGS.....	65
ASSESSMENT CONCLUSION .....	67
RESOURCES AND REFERENCES .....	69
ATTACHMENTS .....	70

**Figures**

Figure 1. Project Site Regional Location..... 23

Figure 2. Aerial Map of Project Vicinity ..... 24

Figure 3. Site Plan ..... 25

Figure 4. IID Imperial Unit Boundary and Canal Network..... 27

Figure 5. Major Colorado River Reservoir Storage Facilities and Basin Location Map..... 41

Figure 6. Lake Mead Water Elevation Levels 01.29.23 visit <<http://www.arachnoid.com/NaturalResources/index.html>> ..... 44

Figure 7. Lake Mead Schematic (June 15, 2022) ..... 50

**Tables**

Table 1. Climate Characteristics, Imperial, CA 100-Year Record, 1923-2022..... 15

Table 2. –IID Areawide Annual Precipitation (In), (1990-2022) ..... 28

Table 3. Monthly Mean Temperature (°F) – Imperial, CA 10-Year, 30-Year & 100-Year (2013-2022, 1993-2022, 1923-2022)..... 28

Table 4. Monthly Mean Rainfall (In) – Imperial, CA 10-Year, 30-Year & 100-Year (2013-2022, 1993-2022, 1923-2022) ..... 29

Table 5. Non-Agricultural Water Demand within IID Water Service Area, 2015-2055 (KAFY) ..... 31

Table 6. – Historic and forecasted Agricultural Water Consumptive Use and Delivery Demand within IID Water Service Area, 2015-2055 (KAFY) ..... 32

Table 7. - IID System Operations Consumptive Use within IID Water Service Area and from AAC at Mesa Lateral 5 to Imperial Dam, (KAF), 2020 ..... 33

Table 8. Interim Water Supply Policy 2023 Annual Non-Agricultural Water Supply Development Fee Schedule ..... 33

Table 9. CRWDA Annual 4.4 MAF Apportionment (Priorities 1 to 4) for California Agencies (AFY)..... 39

Table 10. Unregulated Inflow to Lake Powell, Percent of Historic Average, 2000-2022..... 42

Table 11. IID Historic and Forecast Net Consumptive Use for Normal Year, Single-Dry Year and Multiple-Dry Year Water Supply, 2003-2037, et seq. (CRWDA Exhibit B) ..... 47

Table 12. IID Annual Rainfall (In), Net Consumptive Use and Underrun/Overrun Amounts (AF), 1988-2021 ..... 49

Table 13. IID Inadvertent Overrun Payback to the Colorado River under the IOPP, 2013-2022..... 50

Table 14. Project Operational Water Uses (AFY) ..... 56

Table 15. Ten-Year Historic Delivery (AFY), 2012-2021..... 56

Table 16. IID System Operations Consumptive Use within IID Water Service Area and from AAC at Mesa Lateral 5 to Imperial Dam, (KAF), 2022 ..... 58

Table 17. IID Historic and Forecasted Consumptive Use vs CRWDA Exhibit B IID Net Available Consumptive Use, volumes at Imperial Dam (KAFY), 2015-2055 Next Update in 2026 thru 2025 ..... 59

Table 18. 2020 Approved Water Order, Actual CU (Decree Accounting Report) and IID Underrun, KAF at Imperial Dam ..... 59

Table 19. IID Capital Project Alternatives and Cost (May 2009 price levels \$)..... 63

## **Attachments**

---

Attachment A: IID Interim Water Supply Policy for Non-Agricultural Projects

## Acronyms

---

AF	Acre-Foot or Acre-Feet
AFY	Acre-Feet per Year
AOP	Annual Operations Plan
CAP	Central Arizona Project
CDCR	California Department of Corrections and Rehabilitation
CDPH	California Department of Public Health
CDWR	California Department of Water Resources
CEQA	California Environmental Quality Act
CRWDA	Colorado River Water Delivery Agreement
CUP	Conditional Use Permit
CVWD	Coachella Valley Water District
EDP	IID Equitable Distribution Plan
EIS	Environmental Impact Statement
ICPDS	Imperial County Planning and Development Services
ICS	Intentionally Created Surplus
IID	Imperial Irrigation District
IOPP	Inadvertent Overrun Payback Policy
ISG	Interim Surplus Guidelines
IRWMP	Integrated Regional Water Management Plan
IWSP	Interim Water Supply Policy
KAF	Thousand Acre Feet
LAFCO	Local Agency Formation Commission
LCR	Lower Colorado Region
MCI	Municipal, commercial, industrial
MGD	Million Gallons per Day
MW	Megawatt
MWD	Metropolitan Water District of Southern California
NAF	Naval Air Facility
PVID	Palo Verde Irrigation District
QSA/	Quantification Settlement Agreement and Related Agreements
Transfer Agreements	
SB	Senate Bill
SDCWA	San Diego County Water Authority
SNWA	Southern Nevada Water Authority
TLCFP	Temporary Land Conversion Following Policy
USBR	United States Bureau of Reclamation
USEPA	United States Environmental Protection Agency
WSA	Water Supply Assessment

## **PURPOSE OF WATER SUPPLY ASSESSMENT**

This Water Supply Assessment Assessment (WSA) was prepared for the Imperial County Planning and Development Services (Lead Agency) by Chambers Group Incorporated (Chambers Group), regarding the Green Valley Logistics Center Project (“Applicant”). This study is a requirement of California law, specifically Senate Bill 610 (referred to as SB 610). SB 610 is an act that amended Section 21151.9 of the Public Resources Code, and Sections 10631, 10656, 10910, 10911, 10912, and 10915 of the Water Code. SB 221 is an act that amended Section 11010 of the Business and Professions Code, while amending Section 65867.5 and adding Sections 66455.3 and 66473.7 to the Government Code. SB 610 was approved by the Governor and filed with the Secretary of State on October 9, 2001, and became effective January 1, 2002.<sup>1</sup> SB 610 requires a lead agency, to determine that a project (as defined in CWC Section 10912) subject to California Environmental Quality Act (CEQA), to identify any public water system that may supply water for the project and to request the applicants to prepare a specified water supply assessment.

This study has been prepared pursuant to the requirements of CWC Section 10910, as amended by SB 610 (Costa, Chapter 643, Stats. 2001). The purpose of SB 610 is to advance water supply planning efforts in the State of California; therefore, SB 610 requires the Lead Agency, to identify any public water system or water purveyor that may supply water for the project and to prepare the WSA after a consultation. Once the water supply system is identified and water usage is established for construction and operations for the life of the project, the lead agency is then able to coordinate with the local water supplier and make informed land use decisions to help provide California’s cities, farms and rural communities with adequate water supplies.

Under SB 610, water supply assessments must be furnished to local governments for inclusion in any environmental documentation for certain projects (as defined in California Water Code (CWC) Section 10912 [a]) that are subject to the California Environmental Quality Act (CEQA). Due to increased water demands statewide, this water bill seeks to improve the link between information on water availability and certain land use decisions made by cities and counties. This bill takes a significant step toward managing the demand placed on California’s water supply. It provides further regulations and incentives to preserve and protect future water needs. Ultimately, this bill will coordinate local water supply and land use decisions to help provide California’s cities, farms, rural communities and industrial developments with adequate long-term water supplies. The WSA will allow the lead agency to determine whether water supplies will be sufficient to satisfy the demands of the project, in addition to existing and planned future uses.

### **Project Determination According to SB 610 - Water Supply Assessment**

With the introduction of SB 610, any project under the California Environmental Quality Act (CEQA) shall provide a Water Supply Assessment if the project meets the definition of CWC § 10912. Water Code

---

<sup>1</sup>SB 610 amended Section 21151.9 of the California Public Resources Code, and amended Sections 10631, 10656, 10910, 10911, 10912, and 10915, repealed Section 10913, and added and amended Section 10657 of the Water Code. SB 610 was approved by California Governor Gray Davis and filed with the Secretary of State on October 9, 2001.



section 10911(c) requires for that the lead agency “determine, based on the entire record, whether projected water supplies will be sufficient to satisfy the demands of the project, in addition to existing and planned future uses.” Specifically, Water Code section 10910(c)(3) states that “If the projected water demand associated with the proposed project was not accounted for in the most recently adopted urban water management plan, or the public water system has no urban water management plan, the water supply assessment for the project shall include a discussion with regard to whether the total projected water supplies, determined to be available by the city or county for the project during normal, single dry, and multiple dry water years during a 20 year projection, will meet the projected water demand associated with the proposed project, in addition to the public water system’s existing and planned future uses, including agricultural and manufacturing uses.”

After review of CWC § 10912a, and Section 10912 (a)(5)(B), it was determined that that the Green Valley Logistics Center Project is deemed a project as it is considered an industrial use that will occupy 285 acres.

## EXECUTIVE SUMMARY

The Imperial County Planning and Development Services in coordination with Imperial Irrigation District has requested a WSA as part of the environmental review for the proposed Green Valley Logistics Center Project ("Project"). This study is intended for use by the Imperial County Planning and Development Services and Imperial Irrigation District in its evaluation of water supplies for existing and future land uses. The evaluation examines the following water elements:

- Water availability during a normal year
- Water availability during a single dry year, and multiple dry water years
- Water availability during a 54-year projection to meet existing demands
- Expected 54-year water demands of the Project
- Reasonably foreseeable planned future water demands to be served by the Imperial Irrigation District under Equitable Distribution Plan apportionment

The proposed Project site is located at on approximately 285 gross acres within Imperial County (County), California, approximately 1.25 miles north of the City of Imperial. The Project would be west of the Union Pacific Railroad (UPRR), east of SR 86 (Imperial Avenue), north of Harris Road, and south of Newside Drain Number 1 A, entirely within the Mesquite Lake Specific Plan and on land owned by Tomcat Development LLC. The Project would be within Section 31 of Township 14 South, Range 14 East, San Bernardino Base Meridian, and Assessor Parcel Numbers (APNs) 040-340-004, 040-340-006, 040-340-032, and 040-340-033 within IID's Imperial Unit and district boundary and as such is eligible to receive water service.

IID adopted an Interim Water Supply Policy (IWSP) in 2009 for new Non-Agricultural Projects, under which water supplies may be contracted to serve new developments within IID's water service area. For applications processed under the IWSP, applicants shall be required to pay a processing fee and, after IID board approval of the corresponding water supply agreement, will be required to pay a reservation fee(s) and annual water supply development fees. The water supply development fees are collected for the development of water supply projects, such as water conservation projects, water storage projects and/or water augmentation projects.

Under the IWSP, IID may set aside up to 25,000 acre-feet annually (AFY) of IID's Colorado River water supply to serve new non-agricultural projects with water created from IID efficiency conservation projects and programs. As of **January 2023**, a balance of **23,020** AFY remain available under the IWSP for new non-agricultural projects, providing a mechanism for the development of reasonably sufficient water supplies for such projects. The proposed Project water demand of approximately 229 AFY represents 0.10 % of the annual unallocated supply that may be created and set aside for new non-agricultural projects.

The The Imperial County Planning and Development Services anticipates non-agricultural project water supply demand within their jurisdiction, as the land use authority, is unlikely to exhaust the **23,020** AFY available under the IWSP within the foreseeable 54-year planning period. Thus, the proposed Project's estimated water demand, combined with other development anticipated in the area is unlikely to adversely affect IID's ability to provide water to other users in IID's water service area.

In efforts to address any potential water supply/demand imbalances, on June of 2022, IID adopted a revised Equitable Distribution Plan for the apportionment of water to all water user categories including for commercial/industrial water uses such as the proposed Project. Implementation of the EDP initiates every January 1st, and continues throughout the year unless the IID Board of Directors takes specific action. Under the EDP, water supplies may be restricted to Green Valley Logistics Center as described under the IID Water Supply & Demand Section, Equitable Distribution Plan sub-section of this WSA.

IID's EDP implementation efforts in 2022 coincide with efforts communicated by the U.S. Bureau of Reclamation to all Colorado River Basin contractors during the same time period. In June 2022, Commissioner Camille Touton testified before a congressional committee and called for the Basin states to develop a plan before the end of the year to reduce demands by 2-4 million acre-feet per year, through 2026, or the Secretary of the Interior would take regulatory action to force these reductions in order to protect the Colorado River system in light of the prolonged drought conditions and climate change impacts.

California reductions, or the potential for regulatory reductions, by the Secretary of the Interior remain undefined as of the date of this WSA. IID is working diligently with federal agencies and Colorado River contractors to minimize impacts to the local community while simultaneously ramping up water conservation programs in an effort to augment local water supplies, to some degree, should Basin-wide cuts be unavoidable. In the interim, IID has gone on record that its share of the California proposal under a voluntary plan would not exceed 250,000 AFY as long as there are no obligatory reductions imposed.

## PROJECT DESCRIPTION

Tomcat Development LLC is proposing to build, operate, and maintain a railroad facility on approximately 285 acres of private lands in the Imperial Valley in Imperial County. More specifically, the project is located, approximately 1.25 miles north of the City of Imperial. The Project is west of the Union Pacific Railroad (UPRR), east of SR 86 (Imperial Avenue), north of Harris Road, and south of Newside Drain Number 1-A. The Project is entirely within the Mesquite Lake Specific Plan on land owned by Tomcat Development LLC. The Project is within Section 31 of Township 14 South, Range 14 East, San Bernardino Base Meridian on APNs 040-340-004, 040-340-006, 040-340-032 and 040-340-033. The Project site contains existing agricultural operations, including approximately 120 acres of recently harvested wheat that is planted and harvested as a rotation crop between other crops as well as approximately 84 acres that has been periodically farmed and is currently growing sudan grass. The Project has an existing mainline switch on the Union Pacific Railroad and approximately 0.5 mile of on-site track. The Project site has vacant areas that have previously been farmed and the existing Memory Gardens Cemetery. Over the last 10 years, the Project site has consumed approximately 630 acre-feet per year (AFY) of water for agricultural purposes based on an average water use of 5.25 acre-feet per year. Mesquite Lake Specific Plan is located north, east, and south of the Project site, with agricultural land uses and equipment dealerships and other businesses located west of the Project site. North of the site is vacant, disturbed land, followed by a sugar manufacturing facility. East of the site is the UPRR, followed by agricultural fields. South of the site are agricultural fields as well as a property with a CUP for the development of a fertilizer terminal. A mix of agricultural fields and manufacturing uses, including Bakersfield Pipe Supply, RDO Farm Equipment, Empire Construction Machine Rental, and Rain for Rent, are located west of the Project site. The nearest single-family home is located approximately 0.25 mile east of the Project site. Please refer to Figure 1 for the Project's Regional Location (Figure 1. Site Regional Location), and Figure 2 for the Project Site and Vicinity (Figure 2. Aerial View of Project Site and Vicinity).

In general the project can be described as follows:

Tomcat Development LLC (Applicant) is proposing the Green Valley Logistics Center Project (Project or Proposed Project), a Railroad Facility on approximately 285 acres in Imperial County (County), California. The Project would allow for the development and operation of three (3) rail loop tracks totaling approximately 22,000 track feet, a rail ladder track totaling approximately 25,000 track feet, and an approximately 2,000 track feet spur that tie into the adjacent Union Pacific Railroad right-of-way (ROW; 'rail system'). The Railroad Facility will facilitate inbound and outbound trains of commodities as well as the transloading of commodities to and from trucks. Near the tracks will be a warehousing building(s) and covered storage area(s). Also included in the Project are a grain elevator; shipping container depot, including, but not limited to, the function of hay/grain export; a veteran's memorial area adjacent to the existing cemetery; a fuel blending / transloading area, a fueling station, including, but not limited to CNG (compressed natural gas), unleaded fuel, electrical vehicle chargers, hydrogen fueling and diesel; the extension of SoCal Gas's main line will be extended approximately 1.3 miles along State Route 86 to the Project site from Keystone Road to the north; and areas for transloading and storage of commodities (Proposed Project). Further, the Project's Tentative Tract Map proposes to re-configure the existing

parcels and grant of road right-of way to the County for an Industrial Street. After the Tentative Tract Map is approved by the County, a Final Map will need to be recorded to effectuate the proposed property lines and dedicate the road ROW to the County. The Project also includes a specific plan amendment and zone change application to change land use and zoning for a portion of the site from Light and Medium Industrial to Heavy Industrial for land use, and Mesquite Lake Governmental / Special Public and Mesquite Lake Medium Industrial to Mesquite Lake Heavy Industrial for zoning.

The Project site contains existing agricultural operations, including approximately 120 acres of recently harvested wheat that is planted and harvested as a rotation crop between other crops as well as approximately 84 acres that has been periodically farmed and is growing Sudan Grass. The Project has an existing mainline switch on the Union Pacific Railroad and approximately 0.5 mile of on-site track. The Project site has vacant areas that have previously been farmed and the existing Memory Gardens Cemetery. Over the last 10 years, the Project site has consumed approximately 630 acre-feet per year (AFY) of water for agricultural purposes based on an average water use of 5.25 acre-feet per acre per year.

Mesquite Lake Specific Plan is located north, east, and south of the Project site, with agricultural land uses and equipment dealerships and other businesses located west of the Project site. North of the site is vacant, disturbed land, followed by a sugar manufacturing facility. East of the site is the UPRR, followed by agricultural fields. South of the site are agricultural fields as well as a property with a CUP for the development of a fertilizer terminal. A mix of agricultural fields and manufacturing uses, including Bakersfield Pipe Supply, RDO Farm Equipment, Empire Construction Machine Rental, and Rain for Rent, are located west of the Project site. The nearest single-family home is located approximately 0.25 mile east of the Project site.

As previously mentioned, this document incorporates by reference the Mesquite Lake Specific Plan and Mesquite Lake Specific Plan EIR (SCH# 2005021116), both prepared by the County of Imperial in 2006. The Mesquite Lake Specific Plan consists of approximately 5,100 acres located in central Imperial County, between State Route (SR) 86 on the west and SR 111 plus ¼ mile on the east and is bordered by Harris Road on the south and Keystone Road on the north. Imperial County designated the Mesquite Lake Specific Plan Area on the 1993 General Plan to provide an opportunity to develop new job-producing light, medium, and heavy industrial uses. The following specific environmental issues were identified by the County for evaluation in the Mesquite Lake Specific Plan Master Environmental Impact Report (MEIR):

- Agricultural Resources
- Hydrology and Water Quality
- Air Quality and Odor
- Land Use and Planning
- Biological Resources
- Archaeological Resources
- Hazards and Hazardous Materials
- Aesthetics and Visual Resources
- Public Services and Utilities
- Traffic/Circulation



Impacts to Mineral Resources, Noise, Population and Housing, and Recreation were evaluated under the effects found not to be significant section of the MEIR. All other resource areas that are evaluated per the 2022 Appendix G CEQA Guidelines, were not required to be evaluated at the time 2006.

The overall goal of the Mesquite Lake Specific Plan is to support economic development within Imperial County and allow for heavy industrial development in an area that is away from urban conflicts and its cities through job creation in the employment sectors of manufacturing, fabrication, processing, wholesaling, transportation, and energy resource development; and create and preserve an area where a full range of industrial uses with moderate to high nuisance characteristics may locate.

The Project would include the proposed uses as described below:

<b>Use</b>	<b>Logistical Function / Description</b>	<b>Approximate Area (acres)</b>
Existing Cemetery and Memorial Area	Regular Vehicle Traffic	10
Grain Elevator System	Inbound Rail – Outbound Truck for Corn/Grain Distribution to Cattle Feeder Yards	10
Centralized Water Treatment & Storage System	Provide Potable & Fire Water to the Project Area	2
Hay and Grain Export and Container Depot	Hay/Grain: Inbound Truck – Outbound Rail Containers: Inbound Rail – Outbound Rail and Truck	144
Produce / Food Export Transloading/Warehousing	Inbound Truck – Outbound Rail	10
Fuel Blending / Transloading	Inbound Rail – Outbound Truck	10
Fueling Station, including but not Limited to CNG	Trucks Already On-Site Fuel Up and Public Use	9.5
General Commodities: Transloading/Warehousing	Inbound Rail – Outbound Truck	64
Storm Water Retention Basin	Project Hydrology Program	19
Circulation	On-site Project Roadway	6
<b>Total</b>		<b>284.5</b>

As mentioned in Table 1, the Project includes development of a stormwater retention basin. The Project site layout is illustrated in Figure 3, Project Site Plan. The Project's Tentative Tract Map proposes to re-configure the existing parcels, and grant of road right-of way to the County for an Industrial Street. Site uses are further described in Project Operations below.

**ML GS (Mesquite Lake Government/Special Public)**

The ML GS (Mesquite Lake Government/Special Public) zoning designation may be applied within the Specific Plan to allow for the construction, development, and operation of governmental facilities and special public facilities, as permitted in the G/S (Government/Special Public) Zone of the County Land Use Ordinance but excluding jails or other incarceration facilities.

Please refer to Figure 3 for the conceptual project layout and tentative site plan. (**Figure 3.** Project Layout/Site Plan).

**PROJECT CONSTRUCTION:**

Construction of the Project is expected to begin in approximately 2024 and would continue for an estimated 18 months if the site is built-out under a single construction effort. Site preparation is anticipated to take approximately 2 months, grading to take approximately 2 months, and vertical construction to occur over approximately 14 months. The Project is expected to employ approximately 400 construction workers over the course of build-out, with as many as 200 workers on-site daily during construction once structures and buildings go vertical. The Project is expected to use approximately 1,000 AFY of water during construction. Project build-out is expected to occur in approximately 2026. Construction activities of the Proposed Project will be scheduled in compliance with the Mesquite Lake Specific Plan and County's Municipal Code Title 9 for the provisions of operating and permitting the use of tools and equipment during construction, drilling, repair, or alterations. Project construction may occur incrementally overtime as a function of the need for incremental access to rail and other site infrastructure, and accordingly building permits may be issued incrementally over time.

Site preparation will include clearing and grubbing. The land development includes grading the site to create a rough graded street, native soil preparatory work for track facilities, and pads for new construction. The site preparation will include an estimated 150,000 cubic yards of cut and 150,000 cubic yards of fill; soil will be balanced on site. Other material imports would include an import of approximately 140,000 cubic yards of granular select fill for use underneath concrete building pads, an import of approximately 225,000 tons of ballast and 90,000 tons of sub-ballast for the three (3) loop tracks (approximately 22,000 track feet in total), ladder track (approximately 25,000 track feet in total) and rail spur (approximately 2,000 track feet in total), and 28,000 tons of road base for the Industrial Street roadway, which will be surface finished with asphalt concrete. Other on-site flatwork will be finished with asphalt concrete and Portland cement concrete, including building and structural pads, which will be comprised of rebar and Portland cement concrete. A concrete and rebar bridge/over-pass or a culvert/under-pass may ultimately be built in order to take trucks to and from the inside of the loop tracks. Prior to the full loop tracks being constructed, a private roadway will be constructed for access to the central part of the Project.

In order for the aforementioned ladder track to be built approximately 400' of the IID Dahlia Lateral 8 Canal will need to be pipelined near the SE corner of the Project Site. Encroachment Permit drawings

will be prepared and submitted to the IID for the pipelining and proposed ladder tracks. A detail showing the approximate limits of the canal pipelining is provided as follows:

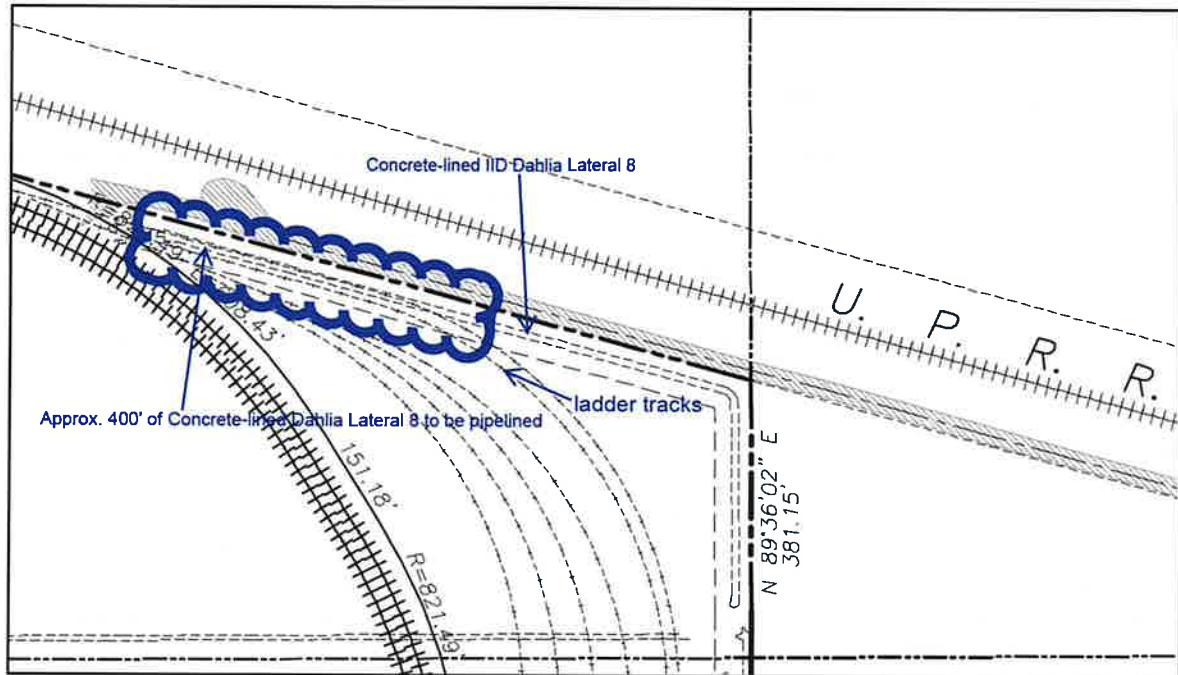

In addition to contractor vehicles, heavy equipment will be used on site and will include, but is not limited to, excavators, backhoes, trenchers, cranes, bulldozers, graders, compactors, track laying equipment, pavers, and dump trucks. All equipment will be staged within the Project site. Access to the UPRR Right-of-Way (ROW) and The County ROW will be needed for construction.

### PROJECT OPERATIONS

Routine operations and maintenance of the facility will include preventative maintenance and repairs of any damaged or otherwise inoperable equipment on an as-needed basis. The operation and maintenance staff will monitor the facility operations over the Project life to ensure that the logistics center is operating to meet design standards. Approximately 56 full-time employees are expected each day of the week during Project operations to cover the below shown elements of the Project, with approximately 2 shifts per day (5am to 1pm and 11am to 7pm). The below shown Project elements will be developed in accordance with Mesquite Lake Specific Plan and County development standards.

### Existing Cemetery and Memorial Area

The existing Memory Gardens Cemetery is part of the subject property and has existing water and electrical service from the Imperial Irrigation District. The property lines around the existing 7-acre cemetery are being adjusted for inclusion of a memorial area in honor of veterans east of and adjacent to the cemetery and the new cemetery overall area will be approximately 10 acres in total. The cemetery and memorial area will be fenced-off from the remaining portion of the Project area with either chain link and privacy slats, wood, or vinyl fencing. Access to the cemetery (and memorial area) will be via the cemetery's existing and historical access from SR 86 or via the frontage road between the

Projects new right in and right out driveways on SR-86. Improvements at the memorial area would consist of landscaping and lighting consistent with Mesquite Lake Specific Plan and County Planning & Development Services requirements. This portion of the cemetery will include memorial improvements, restrooms, and hardscaped walkways and will contain a septic system and leach field in accordance with State and County standards. Water service would be provided from the overall Project's centralized water treatment and distribution system. Raw water for landscaping is currently provided from the IID Dahlia Lateral 8 and such serviced will be continued in the future for irrigation purposes. Volunteers currently maintain the cemetery and will continue to do so in the future, likely under the ownership and management of a newly formed non-profit entity.

#### **Grain Elevator System**

The grain elevator is primarily for receiving corn and similar grain products via rail and distributing them to cattle feeding yards. The grain elevator system will be up to 180 feet tall and be comprised of up to four (4) large tanks/bins initially, expanding to a total of eight (8) large tanks/bins, and several ancillary mechanical components and will be built on a parcel that is approximately 8 acres. The grain elevator would receive approximately 450,000 tons (40-unit trains) of corn annually and approximately 150,000 tons (20 trains) of Dried Distillers Grain (DDG) annually via the Project's tracks. This portion of the Project would employ approximately eight people split between approximately two shifts per day (5am to 1pm and 11am to 7pm). UPRR unit trains are currently 110 rail cars in length; however, the rail industry is moving to expand unit rail length to approximately 126 cars. The DDG would come into the site via approximately 75-car trains and may come in via the loop tracks or via the ladder tracks south of and adjacent to, the loop tracks. Ancillary improvements beyond the actual grain elevator system will be consistent with the Mesquite Lake Specific Plan and County Planning & Development Services requirements, including development of office area, landscaping, and lighting. This portion of the Project would also include restrooms, hardscaped walkways, and hydrants for fire suppression. This portion of the Project would contain a septic system and leach field in accordance with State and County standards and water for the restrooms, fire water and water for operations would be provided from the overall project's centralized water treatment and distribution system or as otherwise approved by the County.

#### **Centralized Water Treatment, Storage & Distribution System**

The Project will include a water treatment, storage and distribution system that will satisfy potable water and fire water requirements. The system will receive water from the IID Dahlia Lateral 8 located along the southerly boundary of the Project. The treatment, storage and pump elements of the system will be located on the approximately 2-acres. The distribution element of the system will be a looped pressurized water line that will provide access to water for all Project parcels. The water treatment, storage and distribution system will likely be developed in phases with an initial phase having a storage capacity of approximately 180,000 gallons and a built-out storage capacity of up to 1.5 million gallons. A 1.5 million gallon tank would be approximately 50 feet tall and approximately 100 feet in diameter. During operations and prior to the need for a public water system, the applicant may truck in purified/potable water.

#### **Hay and Grain Export and Container Depot**

The area in the middle of the loop tracks will be used primarily as a shipping container depot and for exporting hay and grain products via UPRR. The hay and grain export and container depot would employ



approximately 12 people split between approximately two shifts per day (5am to 1pm and 11am to 7pm). Hay and grain trucks each carrying approximately twenty-five (25) containerized tons would be required per day to bring inbound hay and grain to the facility where it would be railed to the Ports of Los Angeles and Long Beach. The hay and grain would be grown within the irrigated area of Imperial County and brought to the site intermittently during hours of operation. Ocean shipping containers would arrive on-site via UPRR from the Ports of Los Angeles and Long Beach full of miscellaneous products from overseas that are destined for distribution throughout the United States and Mexico. The miscellaneous products from overseas would be sorted and placed into domestic shipping containers for out-bound shipment via UPRR to major metropolitan hubs throughout the United States. In addition, full containers of miscellaneous products from the Ports of Los Angeles and Long Beach would arrive on-site via UPRR and be transloaded to truck for delivery to Mexico. The ocean shipping containers stuffed with approximately 1,025,000 tons (170-unit trains) of hay and grain annually that would be exported from the site via UPRR and returned to the ports of Los Angeles and Long Beach for shipment overseas to pre-dominantly Asian and Middle Eastern markets. This area will also intermittently receive empty containers from coastal and inland ports for storage and shipping reuse and may be used for the rail served transloading and warehousing of general commodities.

Ancillary improvements beyond the actual hay and grain export and container depot system will be consistent with Mesquite Lake Specific Plan and County Planning & Development Services requirements and include parking, an office area, landscaping, and lighting. This portion of the Project would also include restrooms, hardscaped walkways, and a hydrant for fire suppression. This portion of the Project would contain a septic system and leach field in accordance with State and County standards and water for the restrooms, fire water and water for operations would be provided from the overall project's centralized water treatment and distribution system.

#### Produce / Food Export

The produce export function would employ approximately six people split between approximately two shifts per day (5am to 1pm and 11am to 7pm). Produce would be trucked in on-site from locally grown sources, may be temperature treated (cold storage prior to customer shipment), and would be exported via UPRR to domestic and international customers. Such produces would likely consist of the following: (a) Broccoli: 45,000 tons, (b) Cabbage: 26,000 tons, (c) Carrot: 128,000 tons, (d) Cauliflower: 77,000 tons, (e) Cantaloupe: 120,000 tons, (f) Citrus: 2,000 tons, (g) Onion: 110,000 tons, and (f) beef: 42,000 tons.

Produce and food grown outside of the County would be railed into the County via UPRR, sorted, stored and shipped to Mexico via truck. Such produce and food would likely consist of the following: (a) Apples, Onions and Potatoes: 35,000 tons, (b) Dry food goods : 20,000 tons, (c) Palletized food products packaged in cans : 25,000 tons, (d) Frozen pork : 145,000 tons, (e) Frozen poultry : 160,000 tons, and (f) Processed food grain corn in super sacks : 20,000 tons.

Ancillary improvements beyond the actual product export system include parking, office area, landscaping, and lighting consistent with Mesquite Lake Specific Plan and County Planning & Development Services requirements. This portion of the Project would also include restrooms, hardscaped walkways, and hydrants for fire suppression. This portion of the Project would contain a septic system and leach field in accordance with State and County standards and water for the restrooms, fire water and water for operations would be provided from the overall project's centralized water treatment and distribution system.



**Fuel Blending / Transloading**

Fuel products will be railed in on-site and transloaded/blended for outbound movement via truck to off-site locations, including Mexico. The approximate amount of fuel that will be annually transloaded/blended at the Project are as follows: (a) Biodiesel fuel: 130,000,000 gallons, (b) Regular diesel: 50,000,000 gallons, and (c) Liquefied Petroleum Gas (LPG)/Natural Gas Liquids (NGL): 90,000,000 gallons. The fuel blending / transloading function would employ approximately four people split between approximately two shifts per day (5am to 1pm and 11am to 7pm).

Ancillary improvements beyond the actual fuel blending / transloading system include, but are not limited to, parking, office area, landscaping, and lighting consistent with Mesquite Lake Specific Plan and County Planning & Development Services requirements. This portion of the Project would also include restrooms, hardscaped walkways, and hydrant(s) for fire suppression. This portion of the Project would contain a septic system and leach field in accordance with State and County standards and water for the restrooms, fire water and water for operations would be provided from the overall project's centralized water treatment and distribution system.

**Fueling Station Including CNG**

The fueling station would be used to fuel vehicles and trucks on site. The approximate amount of fuel sold from the fueling station on an annual basis is as follows: (a) Unleaded fuel: 2,500,000 gallons, (b) Diesel: 4,750,000 gallons, (c) CNG: 5,500,000 gallons. Electric vehicles and hydrogen fuel cell vehicles will also be able to fill up at the fueling station. . The SoCal Gas pipeline that is being extended to the Project site approximately 1.3 miles along State Route 86 from Keystone Road would supply gas to the CNG fueling component of the fueling station.

Ancillary improvements beyond the actual fueling station system include, but are not limited to, landscaping and lighting consistent with Mesquite Lake Specific Plan and County Planning & Development Services requirements, hardscaped walkways, and hydrant(s) for fire suppression. This portion of the Project would contain a septic system and leach field in accordance with State and County standards and water for the restrooms, fire water and water for operations would be provided from the overall project's centralized water treatment and distribution system.

**General Commodities: Transloading/Warehousing**

The remaining portion of the Project area that is not occupied by the rail system and above-mentioned Project elements will be used for the transloading, storage and shipment of additional commodities. The approximate types and amounts of general commodities being transloaded/warehoused on an annual basis on site is as follows: (a) Lumber: 150,000 tons, (b) Fertilizers: 30,000 tons, (c) Plastics: 60,000 tons, (d) Rolled Steel: 85,000 tons, (e) 35% Hydrochloric Acid: 60,000 tons, (f) 50% Caustic Soda: 40,000 tons, (g) 95% Sulfuric Acid: 25,000 tons and (h) Paper: 50,000 tons.. Transloading/warehousing of general commodities would employ approximately 18 people split between approximately two shifts per day (5am to 1pm and 11am to 7pm).

Ancillary improvements beyond the transloading/warehousing system(s) include, but are not limited to, parking, office area, landscaping, and lighting consistent with Mesquite Lake Specific Plan and County Planning & Development Services requirements. This portion of the Project would also include restrooms, hardscaped walkways, and tanks for fire suppression. This portion of the Project would

contain a septic system and leach field in accordance with State and County standards and filtration treated raw water for the restrooms and raw water service from IID for operations, along with trucked in drinking water.

### Parking and Site Access

The Project will be accessed from State Route 86 via a new 72-foot-wide Industrial Street and 2 driveways. The cemetery and memorial area will be accessed via its existing historical SR 86 access or via a frontage road located between the 2 new State Route 86 access points. All individual elements of the logistics center will each have their own quantity of dedicated parking spots consistent with the Signs, Parking and Fences section of the Mesquite Lake Specific Plan. After all related approvals are complete and prior to building permit issuance, the applicant will submit final site plan with proposed parking to County Planning & Development Services for review and approval.

### Stormwater

The entire Project site would drain into a stormwater retention basin located on the northern portion of the Project site that is approximately 19 acres.

This Project retention basin will connect and drain into the IID Newside Drain Number 1-A after upgrading the site's historical connection to said IID drain. The upgrade typically consists of the installation of a storm drain manhole with a one-way flapper valve along the existing pipe that conveys storm water/tail water from the drop box inlet on the adjacent private property to the point of outflow within the IID drain. Said manhole is typically located outside of the IID drain right-of-way and an upstream segment of new pipe is typically connected to said manhole along with a new inlet installed at the low point of the retention basin. An example of a typical construction detail is shown below. Encroachment Permit drawings will be prepared and submitted to IID for the drain connection. The retention basin will be designed to meet SWRCB requirements and will include an appropriate mosquito abatement per County guidelines if the retention basin does fully discharge in less than 72 hours.

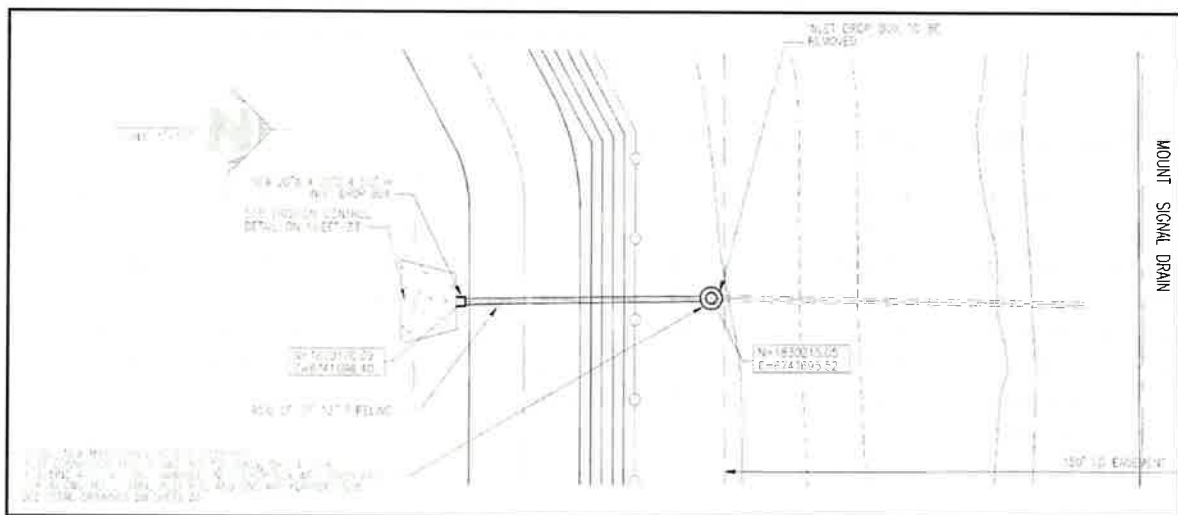

The potable water provider for the Project is the IID. The Project will receive raw water from IID via the Dahlia Lateral 8 and treat said raw water to potable standards for distribution to all Project elements

which will procure their own respective quantities of water. Conversely, if potable treatment and distribution throughout the Project is cost prohibitive, individual users of the Project may address potable water by other means e.g., truck in potable water, individual user treatment facilities, etc. The Project will also have its own dedicated raw water line for access to bulk process water from IID.

Over the last 10 years the Project site has consumed approximately 630 acre-feet of water per year on average in order for 120 acres of the Project site to be farmed. The proposed Project owner will need to contract with IID to deliver up to 180 AFY of untreated water, via the Dahliah Lateral 8 . The proposed Project is anticipated to use approximately 180 AFY of water for the uses listed in Table 9, which includes necessary for periodic dust control while in operation.

**Table 9: Proposed Water Use**

<b>Use</b>	<b>Acre-Feet Per Year (AFY)</b>
<b>Existing</b>	
Agricultural Operations	630
<i>Total</i>	<i>630</i>
<b>Proposed</b>	
Existing Cemetery and Memorial Area	50
Grain Elevator System	20
Hay and Grain Export and Container Depot	30
Produce / Food Export	25
Fuel Blending / Transloading	15
Fueling Station Including CNG	10
General Commodities: Transloading/Warehouse	30
<i>Total</i>	<i>180</i>
<b>Net Decrease</b>	<b>450</b>

The Project will include septic systems with leach fields for the different elements of the logistics center in accordance with State and County standards. Electrical service will be from IID existing on-site distribution level voltage facilities near the cemetery, the existing IID on-site distribution level voltage

facilities near the UPRR, IID existing distribution level voltage facilities south of the site along Harris Road, and/or self-generated with solar panels. If solar panels are used, they would be installed on the roofs of buildings and would interconnect by way of a bi-directional meter that would also serve as the metering element for power purchased from IID. The solar panels would be used solely for Project operations. The solar panels could utilize a battery energy storage element that would require approval from the County Planning Department, prior to installation.

Natural gas will come from the SoCal Gas existing pipeline system on Keystone Road. IID also has transmission level voltage facilities east of the site along the UPRR ROW, which can be tapped as needed for substation development. The applicant will develop the necessary off-site improvements that are required to bring natural gas service to the Project site. The Project will contract with third party utility companies for other utilities like telecom, internet and solid waste pick up services.

### **Fire Protection and Safety**

Water for fire protection would be purchased from IID and stored in ponds and/or above ground storage tanks in accordance with County Fire Department standards. The system will be designed in accordance with federal, state, and local fire codes, occupational health and safety regulations and other jurisdictional codes, requirements, and standard practices.

### **Hazardous Materials and Waste**

The Project will develop and implement a Hazardous Materials Business Plan (HMBP), in compliance with California Health and Safety Code, Division 20, Chapter 6.95, Sections 25500-25519 and California Code of Regulations, Title 19, Division 2, Chapter 4. The HMBP will be provided to the California Office of Emergency Services, the County Fire Department, and the Certified Unified Program Agency for the County (the local California Department of Toxic Substances Control office), for review and approval before plant operation. The HMBP will include, at a minimum, procedures for:

- Hazardous materials handling, use and storage
- Emergency response
- Spill control and prevention
- Employee training
- Reporting and record keeping

Portable bins or other storage containers will be on site for storage of maintenance lube oils, chemicals, paints, and other construction materials, as needed. Hazardous materials that are expected to be used during construction will include:

- Unleaded gasoline
- Diesel fuel
- Oil
- Hydraulic fluids
- Lubricants
- Solvents
- Adhesives
- Paint material

Hazardous materials that are expected to be used during operation will include:

- Unleaded gasoline
- Diesel fuel
- Transformer Oil
- Hydraulic fluid

Hazardous material carriers and hazardous waste transporters are required by law to adhere to applicable local, State, and federal regulations regarding proper truck signage, indicating the materials being transported, carrying a shipping/waste manifest of the types and concentrations of materials being transported, and other appropriate measures. Hazardous material carriers also are responsible for their loads, reporting spills, and initiating appropriate emergency response to releases of any transported hazardous materials, from the point of origin up to the destination of the hazardous material delivery.

#### **PROJECT DECOMMISSIONING AND ABANDONMENT**

The projected life of the Project is approximately 54 years. At the end of operations, a Site Abandonment Plan will be prepared and implemented in conformance with The County and CUPA requirements, for consideration by the Planning Commission prior to Project approval. The Plan will describe the proposed equipment dismantling and site restoration program in conformance with the wishes of the respective landowners/lessors and requirements in effect at the time of abandonment and would be implemented at the end of Project operations.

The Project proposes to incorporate the Best Management Practices for water use efficiency under the requested operational water supply amount of 180 AFY **that consist of the following:**

- **Water use survey every 5 years to determine if new efficiencies are commercially reasonable**
- **Recycle and re-use of water if commercially reasonable for project operations**
- **Xeriscaping is the preferred type of landscaping for the Project**
- **In-bound and out-bound metering for treatment systems if commercially reasonable**

Should reductions to IID's water supply be ordered or directed from a governmental authority having appropriate jurisdiction, the Green Valley Logistics Center may be required to reduce its water supply demand by a proportionate reduction of the total volume of water available to IID. Additional, operational changes that may be implemented by the Project under these unpredictable conditions are as follows:

- Switch conventional landscaping to xeriscaping
- Installation of on-site signage to encourage employees and visitors to use less water



**Figure 1. Project Site Regional Location**

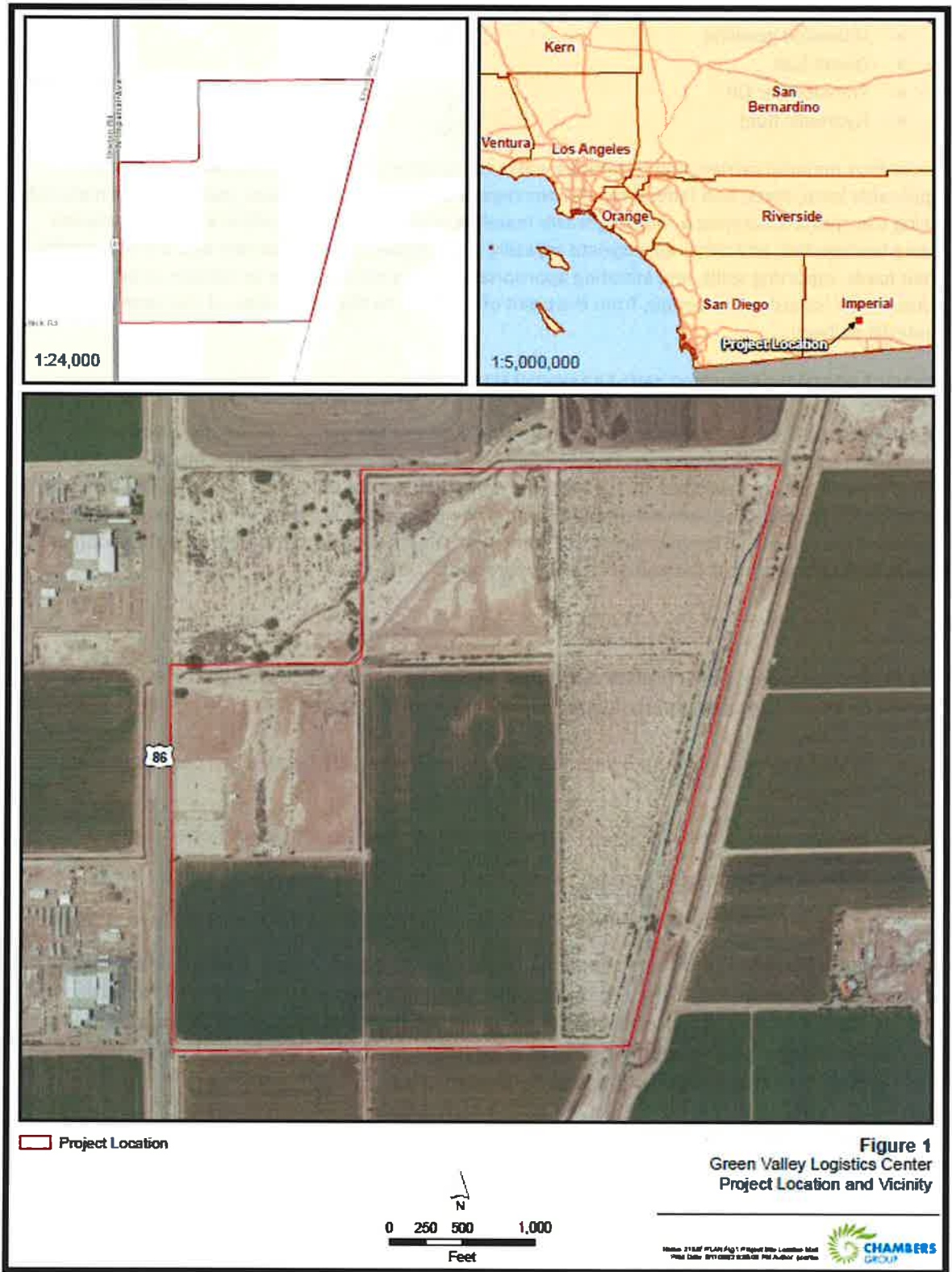

Figure 2. Aerial Map of Project Vicinity





## Description of IID Service Area

The proposed Project site is located in Imperial County in the southeastern corner of California. The County is comprised of approximately 4,597 square miles or 2,942,080 acres.<sup>2</sup> Imperial County is bordered by San Diego County to the west, Riverside County to the north, the Colorado River/Arizona boundary to the east, and 84 miles of International Boundary with the Republic of Mexico to the south. Approximately fifty percent of Imperial County is undeveloped land under federal ownership and jurisdiction. The Salton Sea accounts for approximately 11 percent of Imperial County's surface area. In 2022, sixteen percent (16%) of the area was in irrigated agriculture (468,226 acres), including 14,676 acres of the Yuma Project, some 35 sections or 6,405 acres served by Palo Verde Irrigation District (PVID), and 447,147 acres served by IID.<sup>3</sup>

The area primarily served by IID is located in the Imperial Valley, which is generally contiguous with IID's Imperial Unit, lies south of the Salton Sea, north of the U.S./Mexico International Border, and generally in the 699,132 acre area between IID's Westside Main and East Highline Canals.<sup>4</sup> In 2022, IID delivered untreated water to 495,884 net irrigated acres, predominantly in the Imperial Valley, along with small areas of East and West Mesa land, including non-agricultural uses.

The developed area consists of seven incorporated cities (Brawley, Calexico, Calipatria, El Centro, Holtville, Imperial and Westmorland), three unincorporated communities (Heber, Niland and Seeley), and three institutions (Naval Air Facility [NAF] El Centro, Calipatria CDCR, and Centinela CDCR) and supporting facilities. **Figure 4** provides a map of the IID canal network, as well as cities, communities and main canals.

## Climate Factors

Imperial Valley, located in the Northern Sonoran Desert, which has a subtropical desert climate is characterized by hot, dry summers and mild winters. Clear and sunny conditions typically prevail, and frost is rare. The region receives 85 to 90 percent of possible sunshine each year, the highest in the United States. Winter temperatures are mild rarely dropping below 32°F, but summer temperatures are very hot, with more than 100 days over 100°F each year. The remainder of the year has a relatively mild climate with temperatures averaging in the mid-70s.

The 100-year average climate characteristics are provided in **Table 1**. Rainfall contributes around 50,000 AF of effective agricultural water per inch of rain. Most rainfall occurs from November through March; however, summer storms can be significant in some years. Annual areawide rainfall is shown in **Table 2**. The thirty-year, 1993-2022, average annual air temperature was 73.95°F, and average annual rainfall was

---

<sup>2</sup> *Imperial County General Plan, Land Use Element 2008 Update*

<sup>3</sup> *USBR website: [Yuma Project](#). PVID contact for acreage February 13, 2022.*

<sup>4</sup> *[IID Annual Inventory of Areas Receiving Water Years 2021, 2020, 2019](#)*



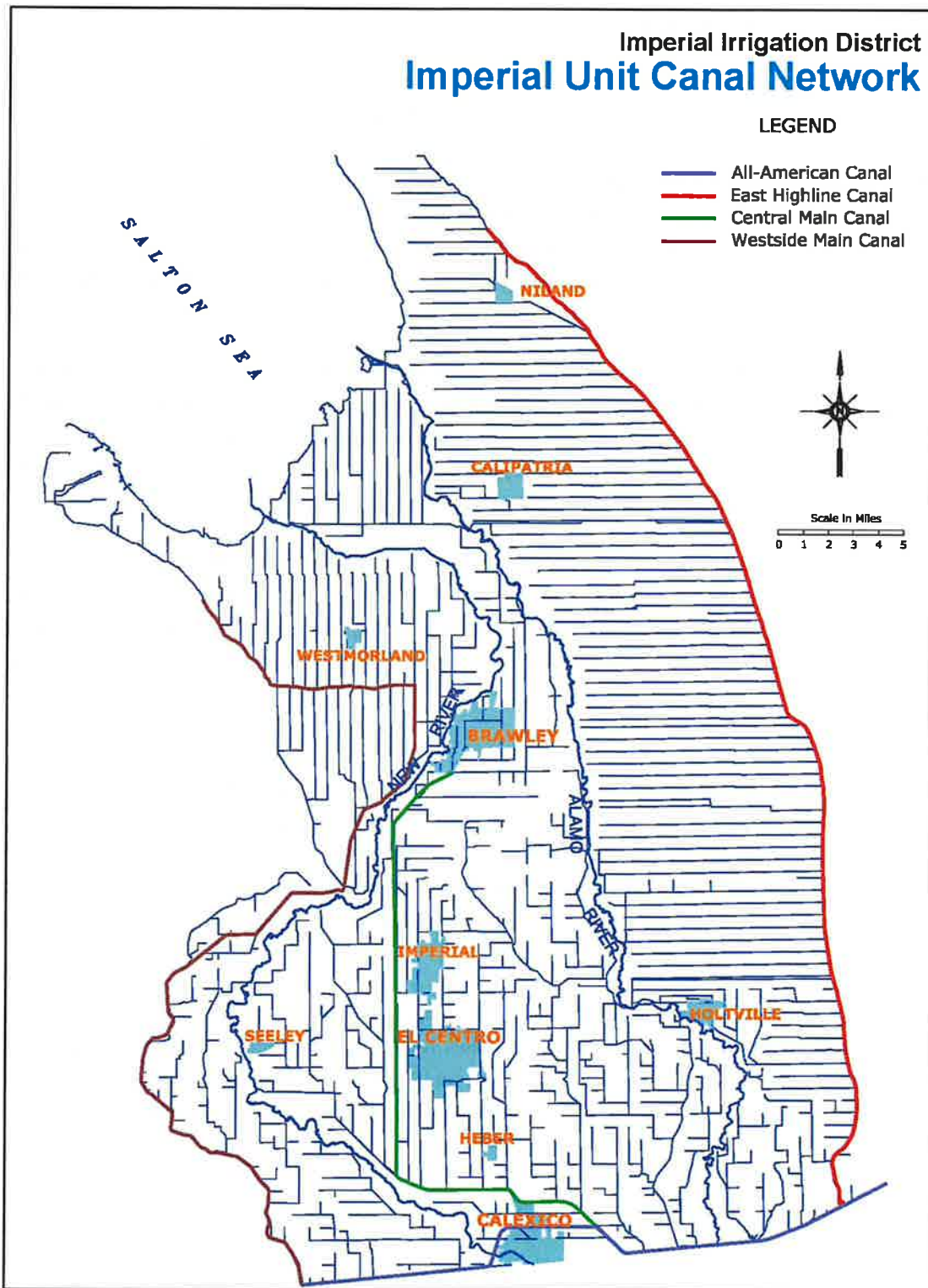

Figure 4. IID Imperial Unit Boundary and Canal Network



2.51 inches, see **Table 4** and **Table 3**. This record shows that while average annual rainfall has fluctuated, the 10-year average temperatures have slightly increased over the 30-year averages.

**Table 1. Climate Characteristics, Imperial, CA 100-Year Record, 1923-2022**

Climate Characteristic	Annual Value
Average Precipitation (100-year record, 1923-2022)	2.75 inches (In)
Minimum Temperature, Jan 1937	16 °F
Maximum Temperature, July 1995	121 °F
Average Minimum Temperature, 1923-2022	48.4 °F
Average Maximum Temperature, 1923-2022	98.4 °F
Average Temperature, 1923-2022	73.1 °F

Source: IID Imperial Weather Station Record

**Table 2. -IID Areawide Annual Precipitation (In), (1990-2022)**

<b>1990</b>	<b>1991</b>	<b>1992</b>	<b>1993</b>	<b>1994</b>	<b>1995</b>	<b>1996</b>
1.646	3.347	4.939	2.784	1.775	1.251	0.685
<b>1997</b>	<b>1998</b>	<b>1999</b>	<b>2000</b>	<b>2001</b>	<b>2002</b>	<b>2003</b>
1.328	2.604	1.399	0.612	0.516	0.266	2.402
<b>2004</b>	<b>2005</b>	<b>2006</b>	<b>2007</b>	<b>2008</b>	<b>2009</b>	<b>2010</b>
4.116	4.140	0.410	1.331	1.301	0.619	3.907
<b>2011</b>	<b>2012</b>	<b>2013</b>	<b>2014</b>	<b>2015</b>	<b>2016</b>	<b>2017</b>
2.261	2.752	2.772	1.103	2.000	1.867	2.183
<b>2018</b>	<b>2019</b>	<b>2020</b>	<b>2021</b>	<b>2022</b>		
1.305	3.017	2.685	1.688	1.265		

Source: Computation based on polygon average of CIMIS as station came online in the WIS.<sup>5</sup>

Notable from Table 2 (above) and Table 3 (below) is that while average annual rainfall measured at IID Headquarters in Imperial, California, has been decreasing, monthly average temperatures are remarkably consistent.

**Table 3. Monthly Mean Temperature (°F) – Imperial, CA 10-Year, 30-Year & 100-Year (2013-2022, 1993-2022, 1923-2022)**

	Jan			Feb			Mar			Apr		
	Max	Min	Avg	Max	Min	Avg	Max	Min	Avg	Max	Min	Avg
<b>10-year</b>	81	33	57	87	37	62	94	43	68	101	49	74
<b>30-year</b>	81	34	57	84	36	60	93	41	66	99	47	72
<b>100-year</b>	80	31	56	84	35	59	91	40	65	99	46	71
	May			Jun			Jul			Aug		
	Max	Min	Avg	Max	Min	Avg	Max	Min	Avg	Max	Min	Avg
<b>10-year</b>	105	55	77	116	62	89	115	72	94	114	72	93
<b>30-year</b>	106	54	78	113	60	87	115	69	92	114	70	92
<b>100-year</b>	105	53	78	113	59	86	114	68	92	113	68	91
	Sep			Oct			Nov			Dec		
	Max	Min	Avg	Max	Min	Avg	Max	Min	Avg	Max	Min	Avg
<b>10-year</b>	111	64	88	100	53	77	91	40	65	81	34	57
<b>30-year</b>	111	62	87	102	50	76	90	39	64	80	33	56
<b>100-year</b>	110	61	86	101	49	75	89	38	63	80	32	56

Source: IID Imperial Headquarters Station Record (Data provided by IID staff)

<sup>5</sup> From 1/1/1990-3/23/2004, 3 CIMIS stations: Seeley, Calipatria/Mulberry, Meloland; 3/24/2004-7/5/2009, 4 CIMIS stations (added Westmorland N.); 7/6/2009-12/1/2009, 3 CIMIS stations: Westmorland N. offline; 12/2/2009-2/31/2009, 4 CIMIS stations, Westmorland N. back online; 1/1/2010-9/20/2010.

**Table 4. Monthly Mean Rainfall (In) – Imperial, CA 10-Year, 30-Year & 100-Year (2013-2022, 1993-2022, 1923-2022)**

	Jan	Feb	Mar	Apr	May	Jun	Jul	Aug	Sep	Oct	Nov	Dec	Annual
10-year	0.47	0.13	0.23	0.11	0.08	0.01	0.08	0.32	0.39	0.12	0.25	0.37	2.47
30-year	0.51	0.38	0.23	0.09	0.06	0.00	0.13	0.20	0.29	0.17	0.21	0.32	2.51
100-year	0.39	0.37	0.25	0.11	0.03	0.00	0.11	0.30	0.37	0.26	0.21	0.49	2.75

Source: IID WIS: CIMIS stations polygon calculation (Data provided by IID staff).

Imperial Valley depends on the Colorado River for its water, which IID transports, untreated, to delivery gates for agricultural, municipal, industrial (including geothermal and solar energy), environmental (managed marsh), recreational (lakes), and other non-agricultural uses. IID supplies the cities, communities, institutions and Golden State Water (which includes all or portions Calipatria, Niland, and some land adjacent within Imperial County territory) with untreated water that they treat to meet state and federal drinking water guidelines before distribution to their customers. Industries outside the municipal areas treat the water to required standards of their industry. To comply with U.S. Environmental Protection Agency (USEPA) requirements and avoid termination of canal water service, residents in the IID water service area who do not receive treated water service must obtain alternative water service for drinking and cooking from a state-approved provider. To avoid penalties that could exceed \$25,000 a day, IID strictly enforces this rule. The IID Water Department tracks nearly 3,200 raw water service accounts required by the State Water Resources Control Board’s Department of Drinking Water to have alternate state approved drinking water service. IID maintains a small-acreage pipe and drinking water database and provides an annual compliance update to the Department of Drinking Water.

### Imperial Valley Historic and Future Land and Water Uses

Agricultural development in the Imperial Valley began at the turn of the twentieth century. In 2021, gross agricultural production for Imperial County was valued at \$2,287,312,000, of which approximately \$2.1 billion was produced in the IID water service area.<sup>6</sup> While the agriculture-based economy is expected to continue, land use is projected to change somewhat over the years as industrial and/or alternative energy development and urbanization occur in rural areas and in areas adjacent to existing urban centers, respectively.

- As and where appropriate, may want to include a sentence or two in this section along the lines of, The Green Valley Logistics Center would support economic development within Imperial County and allow for heavy industrial development in an area that is away from urban conflicts and its cities through job creation in the employment sectors of manufacturing, fabrication, processing, wholesaling, transportation, and energy resource development; and create and preserve an area where a full range of industrial uses with moderate to high nuisance characteristics may locate..

<sup>6</sup> [2021 Imperial County Crop and Livestock Report](#)

Imperial Valley's economy is gradually diversifying. Agriculture will likely continue to be the primary industry within the valley; however, two principal factors anticipated to reduce crop acreage are renewable energy (geothermal and solar) and urban development. Over the next twenty years, urbanization is expected to slightly decrease agriculture land use to provide space for an increase in residential, commercial and industrial uses. The transition from agricultural land use typically results in a net decrease in water demand for municipal, commercial, and solar energy development; and a net increase in water demand for geothermal energy development. Local energy resources include geothermal, wind, biomass and solar. The County General Plan provides for development of energy production centers or energy parks within Imperial County. Alternative energy facilities will help California meet its statutory and regulatory goals for increasing renewable power generation and use and decrease water demands in Imperial County.

The IID Board has adopted the following policies and programs to address how to accommodate water demands under the terms of the QSA/ Transfers Agreements and minimize potential negative impacts on agricultural water uses:

**Imperial Integrated Regional Water Management Plan:** adopted by the board on December 18, 2012, and by the County, the City of Imperial, to meet the basic requirement of California Department of Water Resources (CDWR) for an IRWM plan. In all, 14 local agencies adopted the 2012 Imperial IRWMP.

**Interim Water Supply Policy for Non-Agricultural Projects:** adopted by the board on September 29, 2009, to ensure sufficient water will be available for new development, in particular, anticipated renewable energy projects until the board selects and implements capital development projects such as those considered in the Imperial IRWMP.

**Temporary Land Conversion Fallowing Policy:** adopted by the board on May 8, 2012, and revised on March 29, 2016, to provide a framework for a temporary, long-term fallowing program to work in concert with the IWSP and IID's coordinated land use/water supply strategy.

**Equitable Distribution Plan:** final adoption by the board on June 21, 2022, to provide a mechanism for IID to administer apportionment of the district's quantified annual supply of Colorado River water.

In addition, water users within the IID service area are subject to the statewide requirement of reasonable and beneficial use of water under the California Constitution, Article X, section 2.

### **Imperial Integrated Regional Water Management Plan (October 2012)**

The Imperial IRWMP serves as the governing document for regional water planning to meet present and future water resource needs and demands by addressing such issues as additional water supply options, demand management and determination and prioritization of uses and classes of service provided. In November 2012, the Imperial County Board of Supervisors approved the Imperial IRWMP, and the City of Imperial City Council and the IID Board of Directors approved it in December 2012. Approval by these three (3) stakeholders meets the basic requirement of California Department of Water Resources (CDWR)

for an IRWMP. Through the IRWMP process, IID presented to the region stakeholders options in the event long-term water supply augmentation is needed, such as water storage and banking, recycling of municipal wastewater, and desalination of brackish water.<sup>7</sup> As discussed herein, long term water supply augmentation is not anticipated to be necessary to meet proposed Project demands.

Chapter 5 of the 2012 Imperial IRWMP addresses water supplies (Colorado River and groundwater), demand, baseline and forecasted through 2050; and IID water budget. Chapter 12 addresses projects, programs and policies, and funding alternatives. Chapter 12 of the IRMWP lists, and Appendix N details, a set of capital projects that IID might pursue, including the amount of water that might result (AFY) and cost (\$/AF) if necessary. These also highlight potential capital improvement projects that could be implemented in the future.

Imperial Valley historic 2015 and 2020 and the forecasted future for 2025 to 2055 non-agricultural water demand, are provided in Table 5 in five-year increments. Total water demand for non-agricultural uses is projected to be 201.4 KAF in the year 2055. This is a forecasted increase in the use of non-agricultural water of 94 KAF from 107.4 KAF for the period of 2015 to 2055. These values were modified from Chapter 5 of the Imperial IRWMP to reflect updated conditions from the IID Provisional Water Balance for calendar year 2015 and 2020. Due to the recession in 2009, state policies affecting municipal water use in relation to the drought and other factors, non-agricultural growth projections have lessened since the 2012 Imperial IRWMP. Projections in Table 5 have been adjusted (reduced by 3% for Municipal and Industrial uses and applied a flat .5 AF increase for Recreation use) to reflect IID 2015 and 2020 delivery data adjustments. Even with these adjustments, the Table 5 projections for non-agricultural water demand within the IID water service area continue to reflect an unlikely aggressive growth.

**Table 5. Non-Agricultural Water Demand within IID Water Service Area, 2015-2055 (KAFY)**

	2015	2020	2025	2030	2035	2040	2045	2050	2055
<b>Municipal</b>	30.0	30.9	36.8	39.8	41.5	46.3	51.7	57.8	61.9
<b>Industrial</b>	26.4	28.7	39.8	46.5	53.2	59.9	66.6	73.3	80.0
<b>Other</b>	5.5	5.5	5.5	5.5	5.5	5.5	5.5	5.5	5.5
<b>Feedlots/Dairies</b>	17.8	19.0	20.0	20.0	20.0	20.0	20.0	20.0	20.0
<b>Envr Resources</b>	8.3	9.5	12.0	12.0	12.0	12.0	12.0	12.0	12.0
<b>Recreation</b>	7.4	9.5	10.0	10.0	10.0	10.0	10.0	10.0	10.0
<b>Service Pipes</b>	12.0	12.0	12.0	12.0	12.0	12.0	12.0	12.0	12.0
<b>Total Non Ag</b>	<b>107.4</b>	<b>115.1</b>	<b>136.1</b>	<b>145.8</b>	<b>154.2</b>	<b>165.7</b>	<b>177.8</b>	<b>190.6</b>	<b>201.4</b>

Notes: 2015 non-agricultural water demands are from IID 2015 Provisional Water Balance rerun 01/25/2021 2020-2055 demands are modified from 2012 Imperial IRWMP Chapter 5, Table 5-22 p 5-50 based on IID 2015 Provisional Water Balance. 2020 non-agricultural water demands are from IID 2020 Provisional Water Balance rerun on 01/31/2022. 2025-2055 demands are modified from 2012 Imperial IRWMP Chapter 5, Table 5-22 p 5-50 based on IID 2020 Provisional Water Balance . Industrial Demand includes geothermal, but not solar, energy production.

Agricultural evapotranspiration (ET) demand of approximately 1,476.4 KAF in 2015, decreased in 2020 to approximately 1,442.2 KAF. The termination of fallowing programs provided 103.5 KAF of water for Salton

<sup>7</sup> October 2012 [Imperial Integrated Regional Water Management Plan](#), Chapter 12.



Sea mitigation in 2017. Forecasted agricultural ET remains constant, as reductions in water use are to come from efficiency conservation not reduction in agricultural production. Market forces and other factors may impact forecasted future water demand.

**Table 6** provides the 2015 and 2020 historic and 2025-2055 forecasted agricultural consumptive use and delivery demand within the IID water service area. When accounting for agriculture ET, tailwater and tilewater, total agricultural consumptive use (CU) demand ranges from 2,157.9 KAF in 2015 to 2,208.5 KAF in 2055. Forecasted total agricultural delivery demand is around 1 KAFY higher than the CU demand, ranging from 2,158.9 KAF in 2015 to 2,209.5 KAF in 2055.

**Table 6. – Historic and forecasted Agricultural Water Consumptive Use and Delivery Demand within IID Water Service Area, 2015-2055 (KAFY)**

	2015	2020	2025	2030	2035	2040	2045	2050	2055
Ag ET from Delivered & Stored Soil Water	1,476.4	1,442.2	1,567.5	1,567.5	1,567.5	1,567.5	1,567.5	1,567.5	1,567.5
Ag Tailwater to Salton Sea	282.9	312.9	268.0	218.0	218.0	218.0	218.0	218.0	218.0
Ag Tilewater to Salton Sea	398.6	410.2	423.0	423.0	423.0	423.0	423.0	423.0	423.0
<b>Total Ag CU Demand</b>	<b>2,157.9</b>	<b>2,165.4</b>	<b>2,258.5</b>	<b>2,208.5</b>	<b>2,208.5</b>	<b>2,208.5</b>	<b>2,208.5</b>	<b>2,208.5</b>	<b>2,208.5</b>
<i>Subsurface Flow to Salton Sea</i>	<i>1.0</i>	<i>1.0</i>	<i>1.0</i>	<i>1.0</i>	<i>1.0</i>	<i>1.0</i>	<i>1.0</i>	<i>1.0</i>	<i>1.0</i>
<b>Total Ag Delivery Demand</b>	<b>2,158.9</b>	<b>2,166.4</b>	<b>2,259.5</b>	<b>2,209.5</b>	<b>2,209.5</b>	<b>2,209.5</b>	<b>2,209.5</b>	<b>2,209.5</b>	<b>2,209.5</b>

Notes: 2015 record from IID 2015 Provisional Water Balance rerun 06/28/2019; 2020 record from IID 2020 Provisional Water Balance rerun 01/25/2021; 2020-2055 forecasts from spreadsheet used to develop Figure 19, et seq. in Imperial IRWMP Chapter 5 (Data provided by IID staff). **Next Update 2025**

In addition to agricultural and non-agricultural water demands, system operation demand must be included to account for operational discharge, main and lateral canal seepage, including seepage along the All-American Canal (AAC); and for AAC seepage, river evaporation and phreatophyte ET from Imperial Dam to IID’s measurement site at AAC Mesa Lateral 5. These system operation demands are shown in **Table 7** for 2021. IID measures system operational uses and at All-American Canal Station 2900 just upstream of Mesa Lateral 5 Heading. Total system operational use for 2020 was 167.8 KAF, including 10 KAF of LCWSP input, 39 KAF of seepage interception input, and 40 KAF of unaccounted canal water input.



**Table 7. - IID System Operations Consumptive Use within IID Water Service Area and from AAC at Mesa Lateral 5 to Imperial Dam, (KAF), 2020**

Delivery System Evaporation	24.4
Canal Seepage	90.8
Main Canal Spill	10.1
Lateral Spill	121.5
QSA & IID Seepage Interception	-39.0
Unaccounted Canal Water	-40.0
<b>Total System Operational Use, In valley</b>	<b>167.8</b>
Imperial Dam to AAC @ Mesa Lat 5 (Dam-Mesa Lat 5)( 2,552,674-2,546,152)	9.2
LCWSP	-10
<b>Total System Operational Use in 2020</b>	<b>167.0</b>
<i>Source: 2020 IID Water Balance rerun 01/25/2021</i>	

### **IID Interim Water Supply Policy for Non-Agricultural Projects (September 2009)**

The IID IWSP provides a mechanism to address water supply requests for new non-agricultural projects being developed within the IID service area. The IWSP designates up to 25,000 AFY of water to be conserved from IID’s annual Colorado River water supply, consumptive use cap, for new non-agricultural projects. The IWSP provides a mechanism and process to develop a water supply agreement for any appropriately permitted project, and establishes a framework and set of fees to ensure the supplies used to meet new demands do not adversely affect existing users by funding water conservation or augmentation projects as needed to offset the new demand.<sup>8</sup>

The environmental impacts of conserving up to the 25,000 acre-feet of IWSP water were analyzed in the *Imperial Irrigation District Interim Water Supply Policy for Non-Agricultural Projects Negative Declaration*, State Clearinghouse No. 2009061103 dated June 25, 2009. The IID Board adopted this Negative Declaration on September 29, 2009.

Depending on the nature, complexity and water demands of the proposed project, new projects may be charged a one-time Reservation Fee and annual Water Supply Development Fees for the contracted water volume used solely to assist in funding new water supply projects. The applicability of the fee to certain projects will be determined by IID on a case-by-case basis, depending on the proportion of types of land uses and water demand proposed for a project. The 2023 IWSP fee schedule is shown in Table 8.

**Table 8. Interim Water Supply Policy 2023 Annual Non-Agricultural Water Supply Development Fee Schedule**

Annual Demand (AF)	Reservation Fee (\$/AF)*	Development Fee (\$/AF)*
0-500	\$85.26	\$341.03
501-1000	\$120.04	\$480.17
1001-2500	\$150.74	\$602.94
2501-5000	\$186.20	\$744.81

Adjusted annually in accordance with the Consumer Price Index (CPI).

<sup>8</sup> IID website: [Municipal, Industrial and Commercial Customers](#).

IID customers with new projects receiving water under the IWSP will be charged the appropriate water delivery rate based on measured deliveries, see [IID Water Rate Schedules](#). As of January 2023, IID has issued one water supply agreement under the IWSP for 1,980 AFY, leaving a balance of 23,020 AFY of potential water supply available for additional contracting under the IWSP.

### **IID Temporary Land Conversion Fallowing Policy (May 2012)**

Imperial County planning officials determined that renewable energy facilities were consistent with the county's agricultural zoning designation and began issuing CUPs for these projects with 30-year terms with a 10-year extension (40 years in total). These longer-term, but temporary, land use designations were not conducive to a coordinated land use/water supply policy as envisioned in the Imperial IRWMP, because temporary water supply assignments during a conditional use permit (CUP) term were not sufficient to meet the water supply verification requirements for new project approvals. Agricultural land owners also sought long-term assurances from IID that, at project termination, irrigation service would be available for them to resume their farming operations.

Based on these conditions, IID determined it had to develop a water supply policy that conformed to the local land use decision-making in order to facilitate new development and economic diversity in Imperial County which resulted in the IID Temporary Land Conversion Fallowing Policy (TLCFP).<sup>9</sup> IID concluded that certain lower water use projects could still provide benefits to local water users. The resulting benefits; however, may not be to the same categories of use (e.g., municipal, commercial and industrial) but to the district as a whole.

At the general manager's direction, IID staff developed a framework for a fallowing program that could be used to supplement the IWSP and meet the multiple policy objectives envisioned for the coordinated land use/water supply strategy. Certain private projects that, if implemented, will temporarily remove land from agricultural production within the district's water service area include renewable solar energy and other non-agricultural projects. Such projects may need a short-term water supply for construction and decommissioning activities and longer-term water service for facility operation and maintenance or for treating to potable water standards. Conserved water will be credited to the extent that water use for the new project is less than the historic water use for the project site's footprint as determined by the ten-year water use history.<sup>10</sup>

Water demands for certain non-agricultural projects are typically less than that required for agricultural production; this reduced demand allows conserved water to be made available for other users under IID's annual consumptive use cap. This allows the district to avail itself of the ability during the term of

---

<sup>9</sup> IID website: [Temporary Land Conversion Fallowing Policy \(TLCFP\)](#), and [The TLCFP](#) are the sources of the text for this section.

<sup>10</sup> For details of how water conservation yield attributable to land removed from agricultural production and temporarily fallowed is computed, see [TLCFP for Water Conservation Yield](#).

the QSA/Transfer Agreements under [CWC Section 1013](#) to create conserved water through projects such as temporary land fallowing conservation measures. This conserved water can then be used to satisfy the district's conserved water transfer obligation and for environmental mitigation purposes.

Under the terms of the legislation adopted to facilitate the QSA/Transfer Agreements and enacted in [CWC Section 1013](#), the [TLCFP](#) was adopted by the IID board on May 8, 2012 and revised on March 29, 2016 to update the fee schedule for 2016. This policy provides a framework for a temporary, long-term fallowing program to work in concert with the IWSP. While conserved water generated from the TLCFP is limited by law for use for water transfer or environmental purposes, by satisfying multiple district objectives the TLCFP serves to reduce efficiency conservation and water use reduction demands on IID water users, thus providing district wide benefits.

## **IMPERIAL IRRIGATION DISTRICT'S WATER RIGHTS**

The laws and regulations that influence IID's water supply are noted in this section. The Law of the River (as described below), along with the 2003 Quantification Settlement Agreement and Related Agreements serve as the laws, regulations and agreements that primarily influence the findings of this WSA. These agreements grant California the most senior water rights along the Colorado River and specify that IID has access to 3.1 MAF per year. These two components will influence future decisions in terms of water supply availability during periods of shortages.

### **California Law**

IID has a longstanding right to divert Colorado River water, and IID holds legal titles to all of its water and water rights in trust for landowners within the district (CWC §20529 and §22437; *Bryant v. Yellen*, 447 U.S. 352, 371 (1980), fn.23.). Beginning in 1885, a number of individuals, as well as the California Development Company, made a series of appropriations of Colorado River water under California law for use in the Imperial Valley. The rights to these appropriations were among the properties acquired by IID from the California Development Company.

### **Law of the River**

Colorado River water rights are governed by numerous compacts, state and federal laws, court decisions and decrees, contracts, and regulatory guidelines collectively known as the "Law of the River." Together, these documents form the basis for allocation of the water, regulation of land use, and management of the Colorado River water supply among the seven basin states and Mexico.

Of all regulatory literature that governs Colorado River water rights, the following are the specifics that impact IID:

- Colorado River Compact (1922)
- Boulder Canyon Project Act (1928)

- California Seven-Party Agreement (1931)
- Arizona v. California US Supreme Court Decision (1964, 1979)
- Colorado River Basin Project Act (1968)
- Quantification Settlement Agreement and Related Agreements (2003)
- 2003 Colorado River Water Delivery Agreement: Federal QSA for purposes of Section 5(b) Interim Surplus Guidelines (CRWDA)
- 1970 Criteria for Coordinated Long-Range Operation of Colorado River Reservoirs
- Annual Operating Plan (AOP) for Colorado River Reservoirs
- 2007 Colorado River Interim Guidelines for Lower Basin Shortages and Coordinated Operations for Lakes Powell and Mead (2007 Interim Guidelines)

#### ***Colorado River Compact (1922)***

With authorization of their legislatures and urging of the federal government, representatives from the seven Colorado River basin states began negotiations regarding distribution of water from the Colorado River in 1921. In November 1922, an interstate agreement called the “Colorado River Compact” was signed by the representatives giving the Lower Basin perpetual rights to annual apportionments of 7.5 million acre-feet (MAF) of Colorado River water ( 75 MAF over ten years). The Upper Basin was to receive the remainder, which based on the available hydrological record was also expected to be 7.5 MAF annually, with enough left over to provide 1.5 MAF annually to Mexico.

#### ***Boulder Canyon Project Act (1928)***

Provisions in the 1928 Boulder Canyon Project Act made the compact effective and authorized construction of Hoover Dam and the All-American Canal, and served as the United States’ consent to accept the Compact. Through a Presidential Proclamation on June 25, 1929, this act resulted in ratification of the Compact by six of the basin states and required California to limit its annual consumptive use to 4.4 MAF of the lower basin’s apportionment plus not less than half of any excess or surplus water unapportioned by the Compact. A lawsuit was filed by the State of Arizona after its refusal to sign. Through the implementation of its 1929 Limitation Act, California abided by this federal mandate. The Boulder Canyon Act authorized the Secretary of the Interior (Secretary) to “contract for the storage of water... and for the delivery thereof... for irrigation and domestic uses,” and additionally defined the lower basin’s 7.5 MAF apportionment split, with an annual allocation 0.3 MAF to Nevada, 2.8 MAF to Arizona, and 4.4 MAF to California. Even though the three states never formally settled or agreed to these terms, a 1964 Supreme Court decision (*Arizona v. California*, 373 U.S. 546) declared the three states’ consent to be insignificant since the Boulder Canyon Project Act was authorized by the Secretary.

#### ***California Seven-Party-Agreement (1931)***

Following implementation of the Boulder Canyon Project Act, the Secretary requested that California make recommendations regarding distribution of its apportionment of Colorado River water. In August 1931, under chairmanship of the State Engineer, the California Seven-Party Agreement was developed and authorized by the affected parties to prioritize California water rights. The Secretary accepted this agreement and established these priorities through General Regulations issued in September of 1931. The

first four (4) priority allocations account for California's annual apportionment of 4.4 MAF, with agricultural entities using 3.85 MAF of that total. Additional priorities are defined for years in which the Secretary declares that excess waters are available.

***Arizona v. California U.S. Supreme Court Decision (1964, 1979)***

The 1964 Supreme Court decision settled a 25-year disagreement between Arizona and California that stemmed from Arizona's desire to build the Central Arizona Project to enable use of its full apportionment. California's argument was that as Arizona used water from the Gila River, which is a Colorado River tributary, it was using a portion of its annual Colorado River apportionment. An additional argument from California was that it had developed a historical use of some of Arizona's apportionment, which, under the doctrine of prior appropriation, precluded Arizona from developing the project. California's arguments were rejected by the U.S. Supreme Court. Under direction of the Supreme Court, the Secretary was restricted from delivering water outside of the framework of apportionments defined by law. Preparation of annual reports documenting consumptive use of water in the three lower basin states was also mandated by the Supreme Court. In 1979, present perfected water rights (PPRs) referred to in the Colorado River Compact and in the Boulder Canyon Project Act were addressed by the Supreme Court in the form of a Supplemental Decree.

In March of 2006, a Consolidated Decree was issued by the Supreme Court to provide a single reference to the conditions of the original 1964 decrees and several additional decrees in 1966, 1979, 1984 and 2000 that stemmed from the original ruling. The Consolidated Decree also reflects the settlements of the federal reserved water rights claim for the Fort Yuma Indian Reservation.

***Colorado River Basin Project Act (1968)***

In 1968, various water development projects in both the upper and lower basins, including the Central Arizona Project (CAP) were authorized by Congress. Under the Colorado River Basin Project Act, priority was given to California's apportionment over (before) the CAP water supply in times of shortage. Also under the act, the Secretary was directed to prepare long-range criteria for the Colorado River reservoir system in consultation with the Colorado River Basin States.

***Quantification Settlement Agreement and Related Agreements (2003)***

With completion of a large portion of the CAP infrastructure in 1994, creation of the Arizona Water Banking Authority in 1995, and the growth of Las Vegas in the 1990s, California encountered increasing pressure to live within its rights under the Law of the River. After years of negotiating among Colorado River Compact States and affected California water delivery agencies, a Quantification Settlement Agreement and Related Agreements and documents were signed on October 10, 2003, by the Secretary of Interior, IID, Coachella Valley Water District (CVWD), Metropolitan Water District of Southern California (MWD), San Diego County Water Authority (SDCWA), and other affected parties.

The Quantification Settlement Agreement and Related Agreements (QSA/Transfer Agreements) are a set of interrelated contracts that resolve certain disputes among the United States, the State of California, IID,



MWD, CVWD and SDCWA, for a period of 35 to 75 years, regarding the reasonable and beneficial use of Colorado River water; the ability to conserve, transfer and acquire conserved Colorado River water; the quantification and priority of Priorities 3(a) and 6(a)<sup>11</sup> within California for use of Colorado River water; and the obligation to implement and fund environmental impact mitigation.

Conserved water transfer agreements between IID and SDCWA, IID and CVWD, and IID and MWD are all part of the QSA/Transfer Agreements. For IID, these contracts identify conserved water volumes and establish transfer schedules along with price and payment terms. As specified in the agreements, IID will transfer nearly 415,000 AF annually over a 35-year period (or longer), as follows:

- to MWD 110,000 AF [modified to 105,000 AF in 2007],
- to SDCWA 205,000 AF,
- to CVWD and MWD combined 103,000 AF, and
- to certain San Luis Rey Indian Tribes 11,500 AFY of water.

All of the conserved water will ultimately come from IID system and on-farm efficiency conservation improvements. In the interim, IID has implemented a Fallowing Program to generate water associated with Salton Sea mitigation related to the impacts of the IID/SDCWA water transfer, as required by the State Water Resources Control Board, which is to run from 2003 through 2017. In return for its QSA/Transfer Agreements programs and deliveries, IID will receive payments totaling billions of dollars to fund needed efficiency conservation measures and to pay growers for conserved on-farm water, so IID can transfer nearly 14.5 MAF of water without impacting local productivity. In addition, IID will transfer to SDCWA 67,700 AFY annually of water conserved from the lining of the AAC in exchange for payment of lining project costs and a grant to IID of certain rights to use the conserved water. In addition to the 105,000 acre-feet of water currently being conserved under the 1988 IID/MWD Conservation Program, these more recent agreements define an additional 303,000 AFY to be conserved by IID from on-farm and distribution system conservation projects for transferred to SDCWA, CVWD, and MWD.

#### ***Colorado River Water Delivery Agreement (2003)***<sup>12</sup>

As part of QSA/Transfer Agreements among California and federal agencies, the Colorado River Water Delivery Agreement: Federal QSA for purposes of Section 5(b) Interim Surplus Guidelines (CRWDA) was entered into by the Secretary of the Interior, IID, CVWD, MWD and SDCWA. This agreement involves the federal government because of the change in place of diversion from Imperial Dam into the All-American Canal to Parker Dam into MWD's Colorado River Aqueduct.

The CRWDA assists California to meet its "4.4 Plan" goals by quantifying deliveries for a specific number of years for certain Colorado River entitlements so transfers may occur. In particular, for the term of the

---

<sup>11</sup> Priorities 1, 2, 3(b), 6(b), and 7 of current Section 5 Contracts for the delivery of Colorado River water in the State of California and Indian and miscellaneous Present Perfected Rights within the State of California and other existing surplus water contracts are not affected by the QSA Agreement.

<sup>12</sup> [CRWDA: Federal QSA](#) accessed 7 June 2017.

CRWDA, quantification of Priority 3(a) was effected through caps on water deliveries to IID (consumptive use of 3.1 MAF per year) and CVWD (consumptive use of 330 KAF per year). In addition, California’s Priority 3(a) apportionment between IID and CVWD, with provisions for transfer of supplies involving IID, CVWD, MWD and SDCWA are quantified in the CRWDA for a period of 35 years or 45 years (assumes SDCWA does not terminate in year 35) or 75 years (assumes SDCWA and IID mutually consent to renewal term of 30 years).

Allocations for consumptive use of Colorado River water by IID, CVWD and MWD that will enable California to stay within its basic annual apportionment (4.4 MAF plus not less than half of any declared surplus) are defined by the terms of the QSA/Transfer Agreements (Table 9). As specified in the QSA/Transfer Agreements, by 2026, IID annual use within (Imperial Valley) is to be reduced to just over 2.6 MAF of its 3.1 MAF quantified annual apportionment. The remaining nearly 500,000 AF (which includes the 67,000 AF from AAC lining) are to be transferred annually to urban water users outside of the Imperial Valley.

**Table 9. CRWDA Annual 4.4 MAF Apportionment (Priorities 1 to 4) for California Agencies (AFY)**

User	Apportionment (AFY)
Palo Verde Irrigation District and Yuma Project*	420,000
Imperial Irrigation District	3,100,000
Coachella Valley Water District	330,000
Metropolitan Water District of Southern California*	550,000
<b>Total:</b>	<b>4,400,000</b>

\* PVID and Yuma Project did not agree to a cap; value represents a contractual obligation by MWD to assume responsibility for any overages or be credited with any volume below this value.

Notes: All values are consumptive use at point of Colorado River diversion: Palo Verde Diversion Dam (PVID), Imperial Dam (IID and CVWD), and Parker Dam (MWD). Source: IID Annual Water Report

Quantification of Priority 6(a) was effected through quantifying annual consumptive use amounts to be made available in order of priority to MWD (38 KAF), IID (63 KAF), and CVWD (119 KAF) with the provision that any additional water available to Priority 6(a) be delivered under IID’s and CVWD’s existing water delivery contract with the Secretary<sup>13</sup> The CRWDA provides that the underlying water delivery contract with the Secretary remain in full force and effect. (*Colorado River Documents 2008*, Chapter 6, pages 6-12 and 6-13). The CRWDA also provides a source of water to effect a San Luis Rey Indian Water Rights settlement. Additionally, the CRWDA satisfies the requirement of the 2001 Interim Surplus Guidelines (ISG) that a QSA be adopted as a prerequisite to the interim surplus determination by the Secretary in the ISG.

***Inadvertent Overrun Payback Policy (2003)***

The CRWDA Inadvertent Overrun Payback Policy (IOPP), adopted by the Secretary contemporaneously with the execution of the CRWDA, provides additional flexibility to Colorado River management and applies to entitlement holders in the Lower Division States (Arizona, California and Nevada)<sup>14</sup> The IOPP

<sup>13</sup> When water levels in the Colorado River reservoirs are low, Priority 5, 6 and 7 apportionments are not available for diversion.

<sup>14</sup> USBR, 2003 CRWDA ROD Implementation Agreement, IOPP and Related Federal Actions Final EIS. Section IX. Implementing the Decision A. Inadvertent Overrun and Payback Policy. Pages 16-19 of 34.

defines inadvertent overruns as “Colorado River water diverted, pumped, or received by an entitlement holder of the Lower Division States that is in excess of the water users’ entitlement for the year.” An entitlement holder is allowed a maximum overrun of 10 percent (10%) of its Colorado River water entitlement.

In the event of an overrun, the IOPP provides a mechanism to payback the overrun. When the Secretary has declared a normal year for Colorado River diversions, a contractor has from one to three years to pay back its obligation, with a minimum annual payback equal to 20 percent of the entitlement holder’s maximum allowable cumulative overrun account or 33.3 percent of the total account balance, whichever is greater. However, when Lake Mead is below 1125 feet on January 1, the terms of the IOPP require that the payment of the inadvertent overrun obligation be made in the calendar year after the overrun is reported in the USBR Lower Colorado Region Colorado River Accounting and Water Use Report [for] Arizona, California, and Nevada (Decree Accounting Report).<sup>15</sup>

***1970 Criteria for Coordinated Long-Range Operation of Colorado River Reservoirs***

The 1970 Operating Criteria control operation of the Colorado River reservoirs in compliance with requirements set forth in the Colorado River Compact of 1922, the United States-Mexico Water Treaty of 1944, the Colorado River Storage Project Act of 1956, the Boulder Canyon Projects Act (Lake Mead) and the Colorado River Basin Project Act (Upper Basin Reservoirs) of 1968, and other applicable federal laws. Under these Operating Criteria, the Secretary makes annual determinations published in the USBR Annual Operating Plan for Colorado River Reservoirs (discussed below) regarding the release of Colorado River water for deliveries to the lower basin states. A requirement to equalize active storage between Lake Powell and Lake Mead when there is sufficient storage in the Upper Basin is included in these operating criteria. **Figure 5** identifies the major storage facilities at the upper and lower basin boundaries.

---

<sup>15</sup> 2003 [CRWDA ROD](#). Section IX. A.6.c., page 18 of 34.

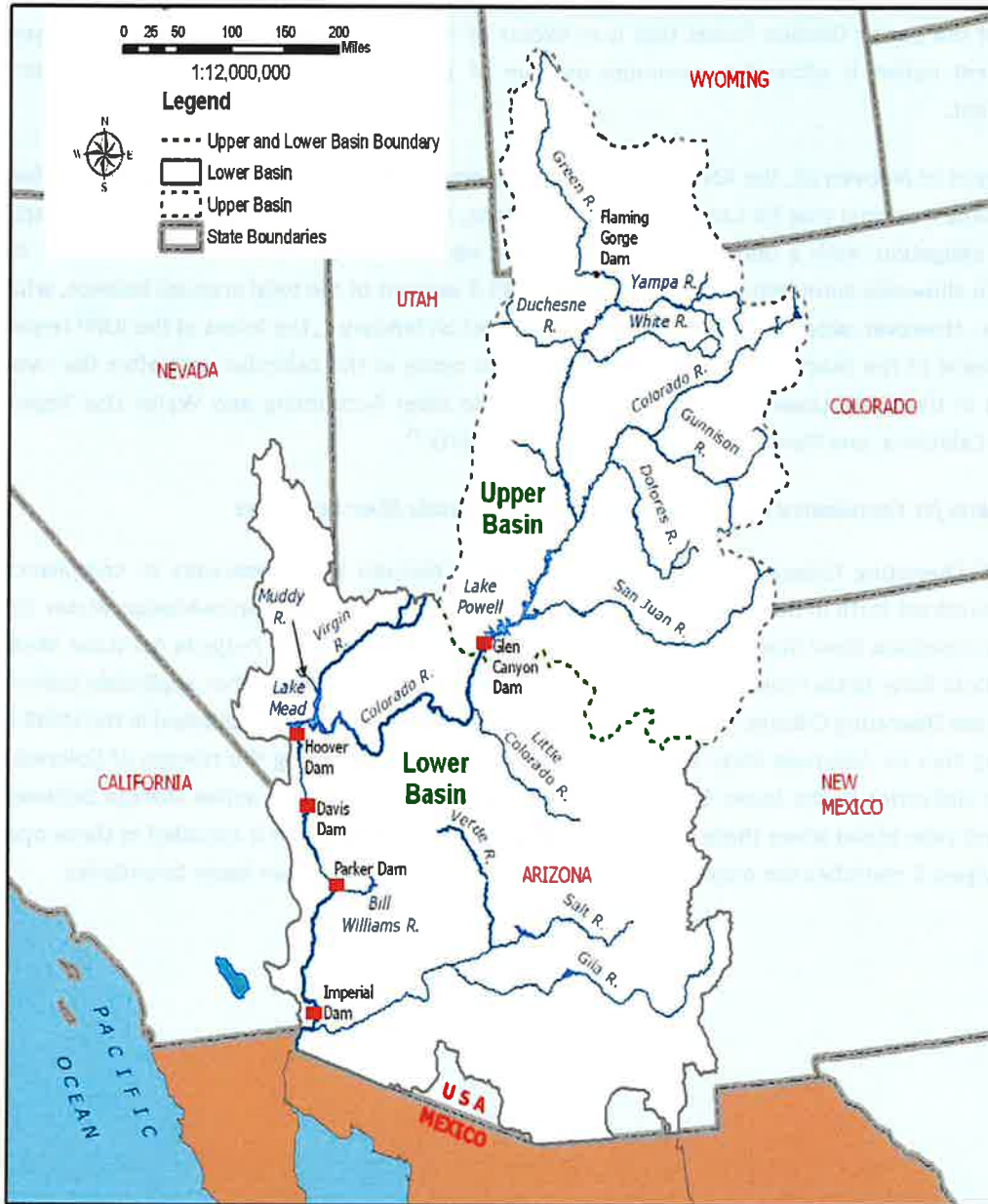

**Figure 5. Major Colorado River Reservoir Storage Facilities and Basin Location Map**  
 Source: [Final EIS – Colorado River Interim Guidelines for Lower Basin Shortages and Coordinated Operations for Lake Powell and Lake Mead, Volume 1 Chapter 1 Purpose and Need](#), p I-10.

**Annual Operating Plan for Colorado River Reservoirs (Applicable when Lake Mead Surplus/Shortage)**

The AOP is developed in accordance with Section 602 of the Colorado River Basin Project Act (Public Law 90-537); the Criteria for Coordinated Long-Range Operations of Colorado River Reservoirs Pursuant to the Colorado River Basin Project Act of 1968, as amended, promulgated by the Secretary of the Interior; and Section 1804(c)(3) of the Grand Canyon Protection Act (Public Law 102-575). As part of the AOP process, the Secretary makes determinations regarding the availability of Colorado River water for deliveries to the lower basin states, including whether normal, surplus, and shortage conditions are in effect on the lower portion of the Colorado River.

**2007 Colorado River Interim Guidelines for Lower Basin Shortages (2007 Interim Guidelines)**

A multi-year drought in the Colorado River Upper Basin triggered the need for the 2007 Interim Shortage Guidelines. In the summer of 1999, Lake Powell was essentially full with reservoir storage at 97 percent of capacity. However, precipitation fell off starting in October 1999 and 2002 inflow was the lowest recorded since Lake Powell began filling in 1963.<sup>16</sup> By August 2011, inflow was 279 percent (279%) of average; however, drought resumed in 2012 and continued through calendar year 2022. Using the record in **Table 10**, average unregulated inflow to Lake Powell for water years 2000-2022 is 70 percent (69.96 %); or if 2011 is excluded, 67 percent (66.95%) of the historic average, see **Table 10**.

**Table 10. Unregulated Inflow to Lake Powell, Percent of Historic Average, 2000-2022**

<b>2000</b>	<b>2001</b>	<b>2002</b>	<b>2003</b>	<b>2004</b>	<b>2005</b>	<b>2006</b>	<b>2007</b>	<b>2008</b>	<b>2009</b>	<b>2010</b>
62%	59%	25%	51%	49%	105%	73%	68%	102%	88%	73%
<b>2011</b>	<b>2012</b>	<b>2013</b>	<b>2014</b>	<b>2015</b>	<b>2016</b>	<b>2017</b>	<b>2018</b>	<b>2019</b>	<b>2020</b>	<b>2021</b>
136%	35%	49%	90%	83%	80%	101%	36%	120%	54%	36%
<b>2022</b>	<b>2023</b>	<b>2024</b>	<b>2025</b>	<b>2026</b>	<b>2027</b>	<b>2028</b>	<b>2029</b>	<b>2030</b>	<b>2031</b>	<b>2032</b>
34%										

Source: [UCR Water Operations: Historic Data \(2000-2022\)](#)

In the midst of the drought period, USBR developed 2007 Interim Guidelines with consensus from the seven basin states, which selected the Draft EIS Preferred Alternative as the basis for USBR’s final determination. The basin states found the Preferred Alternative best met all aspects of the purpose and need for the federal action.<sup>17</sup>

The 2007 Interim Guidelines Preferred Alternative highlights the following:

1. The need for the Interim Guidelines to remain in place for an extended period of time.
2. The desirability of the Preferred Alternative based on the facilitated consensus recommendation from the basin states.
3. The likely durability of the mechanisms adopted in the Preferred Alternative in light of the extraordinary efforts that the basin states and water users have undertaken to develop

<sup>16</sup> Water Year: October 1 through September 30 of following year, so water year ending September 30, 1999

<sup>17</sup> USBR *Colorado River Interim Guidelines for Lower Basin Shortages and Coordinated Operations for Lake Powell and Lake Mead* <<http://www.usbr.gov/lc/region/programs/strategies.html>>



implementing agreements that will facilitate the water management tools (shortage sharing, forbearance, and conservation efforts) identified in the Preferred Alternative

4. That the range of elements in the Preferred Alternative will enhance the Secretary's ability to manage the Colorado River reservoirs in a manner that recognizes the inherent tradeoffs between water delivery and water storage.

In June 2007, USBR announced that a preferred alternative for Colorado River Interim Guidelines for Lower Basin Shortages and Coordinated Operations of Lake Powell and Lake Mead (Final Preferred Alternative) had been determined. The Final Preferred Alternative, based on the basin states' consensus alternative and an alternative submitted by the environmental interests called "Conservation Before Shortage," is comprised of four key operational elements which are to guide operations of Lake Powell and Lake Mead through 2026 are:

1. Shortage strategy for Lake Mead and Lower Division states: The Preferred Alternative proposed discrete levels of shortage volumes associated with Lake Mead elevations to conserve reservoir storage and provide water users and managers in the Lower Basin with greater certainty to know when, and by how much, water deliveries will be reduced during low reservoir conditions.
2. Coordinated operations of Lake Powell and Lake Mead: The Preferred Alternative proposed a fully coordinated operation of the reservoirs to minimize shortages in the Lower Basin and to avoid risk of curtailments of water use in the Upper Basin.
3. Mechanism for storage and delivery of conserved water in Lake Mead: The Preferred Alternative proposed the Intentionally Created Surplus (ICS) mechanism to provide for the creation, accounting, and delivery of conserved system and non-system water thereby promoting water conservation in the Lower Basin. Credits for Colorado River or non-Colorado River water that has been conserved by users in the Lower Basin creating an ICS would be made available for release from Lake Mead at a later time. The total amount of credits would be 2.1 MAF, but this amount could be increased up to 4.2 MAF in future years.
4. Modifying and extending elements of the Interim Surplus Guidelines (ISG). The ISG determines conditions under which surplus water is made available for use within the Lower Division states. These modifications eliminate the most liberal surplus conditions thereby leaving more water in storage to reduce the severity of future shortages.

With respect to the various interests, positions and views of the seven basin states, this provision adds an important element to the evolution of the legal framework for prudent management of the Colorado River. Furthermore, the coordinated operation element allows for adjustment of Lake Powell releases to respond to low reservoir storage conditions in either Lake Powell or Lake Mead. States found the Preferred Alternative best met all aspects of the purpose and need for the federal action.<sup>18</sup> The 2007

---

<sup>18</sup> [USBR Colorado River Interim Guidelines for Lower Basin Shortages and Coordinated Operations for Lake Powell and Lake Mead.](#)

Interim Guidelines are in place from 2008 through December 31, 2025 (through preparation of the 2026 Annual Operating Plan).

**Lower Colorado Region Water Shortage Operations**

The Colorado River Basin is experiencing a prolonged period of drought and record-low runoff conditions that have resulted in historically low reservoir levels in both Lake Powell (upper Basin) and Lake Mead (lower Basin). The period from 2000 through 2021 was the lowest 22-year inflow into Lake Powell in the historical record and has strained the Colorado River system. The drought in the Colorado River watershed has continued through 2023. Despite an increase in observed runoff in August 2011 when unregulated inflow to Lake Powell was 279 percent of the average. Since 2000, Lake Mead has been below the “average” level of lake elevations (see Figure 6). Such conditions have caused the activation of shortage plans for waters users in Arizona and Nevada, and in Mexico. By May of 2022 Lake Meads elevation had declined to 1,048 feet. These conditions resulted in the U.S. Secretary of the Interior declaring the first-ever Tier 2a Shortage on the Colorado River.

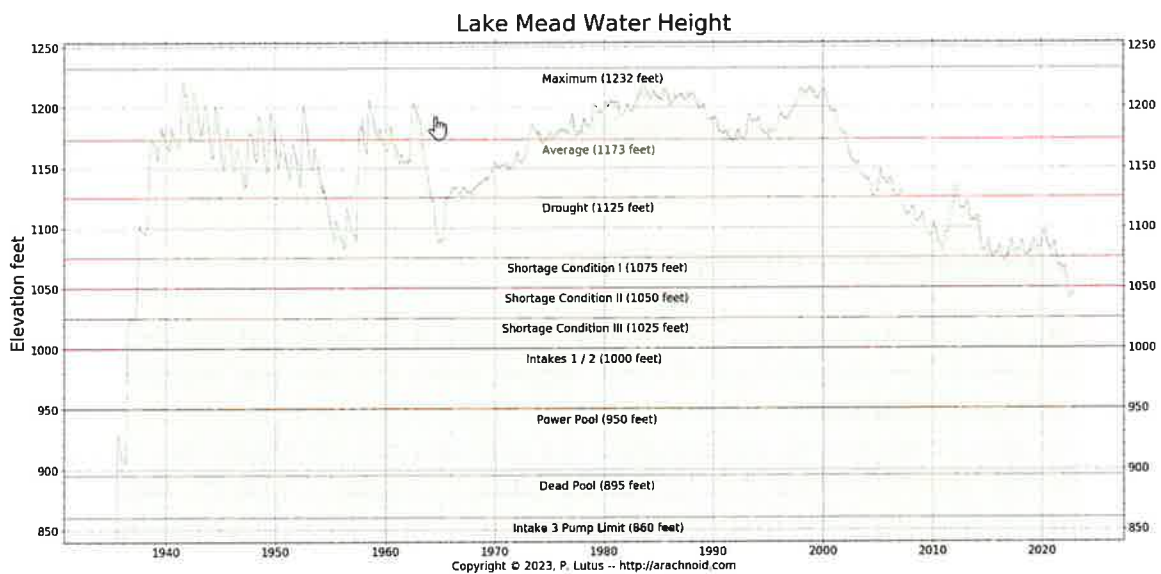

**Figure 6. Lake Mead Water Elevation Levels 01.29.23 visit**  
<http://www.arachnoid.com/NaturalResources/index.html>

According to guidelines put in place in 2007, Arizona and Nevada begin to take shortages when the water elevation in Lake Mead falls below 1,075 feet. The volumes of shortages increase as water levels fall to 1,050 feet and again at 1,025 feet. In 2012, Mexico agreed to participate in a 5-year pilot agreement to share specific volumes of shortages at the same elevations. The 2007 interim shortage guidelines contain no reductions for California, which has senior water rights to the Central Arizona Project water supply, through 2025 when the guidelines expire. If Lake Mead's elevation drops to 1,025 feet, a re-consultation process would be triggered among the basin states to address next steps. Consultation would start out within each state, then move to the three lower basin states, followed by all seven states and the USBR.

Mexico will then be brought into the process unless they choose to participate earlier. In total, 721,000 acre-feet of reductions will be implemented in the Lower Basin and Mexico in 2023 consistent with various agreements that dictate the operation of the Colorado River.

California has no stipulated reduction to its water supplies under a Tier 2a Shortage declaration. While not directly affected by the shortage reductions announced by Reclamation, the Shortage condition does prevent IID from overrunning its approved water order and, as stated earlier, contributions to address Lake Mead water elevation are anticipated by IID. IID is considering voluntary water conservation for the benefit of Lake Mead, up to 250,000 AFY, as long as there are no obligatory reductions.

## **IMPERIAL IRRIGATION DISTRICT WATER SUPPLY AND DEMAND**

SB 610 requires an analysis of a normal, single dry, and multiple dry water years to show that adequate water is available for the proposed Project in various climate scenarios. Water availability for this Project in a normal year is no different from water availability during a single-dry and multiple-dry year scenarios. This is due to the small effect rainfall has on water availability in IID's arid environment along with IID's strong entitlements to the Colorado River water supply. Local rainfall does have some impact on how much water is consumed (i.e. if rain falls on agricultural lands, those lands will not demand as much irrigation), but does not impact the definition of a normal year, a single-dry year or a multiple-dry year scenario.

## **WATER AVAILABILITY – NORMAL YEAR**

IID is entitled to annual net consumptive use of 3.1 MAF of Colorado River, less its QSA/Transfer Agreement obligations. Imperial Dam, located north of Yuma, Arizona, serves as a diversion structure for water deliveries throughout southeastern California, Arizona and Mexico. Water is transported to the IID water service area through the AAC for use throughout the Imperial Valley. IID historic and forecast net consumptive use volumes at Imperial Dam from CRWDA Exhibit B are shown in Table 11. Volumes 2003-2021 are adjusted for USBR Decree Accounting historic records. Volumes for 2022-2077 are from CRWDA Exhibit B modified to reflect 2014 Letter Agreement changes to the 1988 IID/MWD Water Conservation Agreement.<sup>19</sup>

Due to limits on annual consumptive use of Colorado River water under the QSA/Transfer Agreements, IID's water supply during a normal year is best represented by the CRWDA Exhibit B Net Available for Consumptive Use (Table 11, Column 11). The annual volume is IID Priority 3(a) Quantified Amount of 3.1 million acre-feet (MAF) (Table 11, Column 2) less the IID transfer program reductions for each year (Table

---

<sup>19</sup> [2014 Imperial Irrigation District Letter Agreement](#) for Substitution and Conservation Modifications to the IID/MWD Water Conservation Agreement - December 17, 2014.

11, Columns 3-9). IID suggests **Table 10**, which assumes full use of IID's quantified water supply, be used in determining base normal year water availability.

**Table 11. IID Historic and Forecast Net Consumptive Use for Normal Year, Single-Dry Year and Multiple-Dry Year Water Supply, 2003-2037, et seq. (CRWDA Exhibit B)**

IID Quantification and Transfers, Volumes in KAF at Imperial Dam <sup>1</sup>											
Col 1	2	3	4	5	6	7	8	9	10	11	
Year	IID Priority 3(a)										
	IID 3(a) Quantified Amount	IID Reductions								IID Total Reduction (Σ Cols 3-9) <sup>5</sup>	IID Net [Available for] Consumptive Use (Col 2 - 10)
		1988 MWD Transfer <sup>2</sup>	SDCWA Transfer	AAC Lining	Salton Sea Mitigation SDCWA Transfer <sup>3</sup>	Intra-Priority 3 CVWD Transfer	MWD Transfer w\ Salton Sea Restoration <sup>4</sup>	Misc. PPRs			
2003	3,100	105.1	10.0	0.0	0.0	0.0	0.0	11.5	126.6	2978.2	
2004	3,100	101.9	20.0	0.0	15.0	0.0	0.0	11.5	148.4	2743.9	
2005	3,100	101.9	30.0	0.0	15.0	0.0	0.0	11.5	158.4	2756.8	
2006	3,100	101.2	40.0	0.0	20.0	0.0	0.0	11.5	172.7	2909.7	
2007	3,100	105.0	50.0	0.0	25.0	0.0	0.0	11.5	191.5	2872.8	
2008	3,100	105.0	50.0	8.9	26.0	4.0	0.0	11.5	205.4	2825.1	
2009	3,100	105.0	60.0	65.5	30.1	8.0	0.0	11.5	280.1	2566.7	
2010	3,100	105.0	70.0	67.7	33.8	12.0	0.0	11.5	294.8	2540.5	
2011	3,100	103.9	63.3	67.7	0.0	16.0	0.0	11.5	262.4	2915.8	
2012	3,100	104.1	106.7	67.7	15.2	21.0	0.0	11.5	326.2	2,903.2	
2013	3,100	105.0	100.0	67.7	71.4	26.0	0.0	11.5	381.6	2,554.9	
2014	3,100	104.1	100.0	67.7	89.2	31.0	0.0	11.5	403.5	2,533.4	
2015	3,100	107.82	100.0	67.7	153.3	36.0	0.0	11.5	476.3	2,480.9	
2016	3,100	105.0	100.0	67.7	130.8	41.0	0.0	11.5	456.0	2,504.3	
2017	3,100	105.0	100.0	67.7	105.3	45.0	0.0	9.9	432.9	2,667.1	
2018	3,100	105	130	67.7	0.1	63	0.0	9.7	375.5	2,724.5	
2019 <sup>6</sup>	3,100	105	160	67.7	46.55	68	0.0	6.9	454.2	2,645.8	
2020	3,100	105	192.5	67.7	0.0	73	0.0	9.1	448.0	2,652.0	
2021	3,100	105	205	67.7	0.0	78	0.0	9.3	465.0	2,635.0	
2022	3,100	105	202.5	67.7	0	83	0.0	9.8	468.0	2,632.0	
2023	3,100	105	200	67.7	0	88	0.0	11.5	472.2	2,627.8	
2024	3,100	105	200	67.7	0	93	0.0	11.5	477.2	2,622.8	
2025	3,100	105	200	67.7	0	98	0.0	11.5	482.2	2,617.8	
2026	3,100	105	200	67.7	0	103	0.0	11.5	487.2	2,612.8	
2027	3,100	105	200	67.7	0	103	0.0	11.5	487.2	2,612.8	
2028	3,100	105	200	67.7	0	103	0.0	11.5	487.2	2,612.8	
2029-37	3,100	105	200	67.7	0	103	0.0	11.5	487.2	2,612.8	
2038-47 <sup>7</sup>	3,100	105	200	67.7	0	103	0.0	11.5	487.2	2,612.8	
2048-77 <sup>8</sup>	3,100	105	200	67.7	0	50	0.0	11.5	434.2	2,665.8	

1. 2003 through 2022, volumes are adjusted for actual USBR Decree Accounting values; IID Total Reduction and Net Available for Consumptive Use may not equal Col 2 minus Col 10, if IID conservation/use was not included in Exhibit B.
2. 2014 Letter of Agreement provides that, effective January 2016 total amount of conserved water available is 105 KAFY
3. Salton Sea Mitigation volumes may vary based on conservation volumes and method of conservation.
4. *This transfer is not likely given lack of progress on Salton Sea restoration as of 2018; shaded entries represents volumes that may vary..*
5. Reductions include conservation for 1988 IID/MWD Transfer, IID/SDCWA Transfer, AAC Lining; SDCWA Transfer Mitigation, MWD Transfer w/Salton Sea Restoration (if any); Misc. PPRs. Amounts are independent of increases and reductions as allowed by the IOPP.
6. In order to resolve the outstanding 2010 Salton Sea mitigation water pre-delivery issue, IID left 46,546 AF of extraordinary conservation in Lake Mead. See IID's December 19, 2019 revised 2019 water order and Reclamation's March 10, 2020 approval letter.
7. Assumes SDCWA does not elect termination in year 35.
8. Assumes SDCWA and IID mutually consent to renewal term of 30 years.
9. Modified from 100 KAFY in CRWDA Exhibit B; stating in 2018 MWD will provide CVWD 50 KAFY of the 100 KAFY.

Source: [CRWDA: Federal QSA Exhibit B](#), p 13; updated values from [2021 Annual Water & QSA Implementation Report](#)



CRWDA Exhibit B Net Available for Consumptive Use volumes less system operation demand represents the amount of water available for delivery by IID Water Department to its customers each year. In a normal year, perhaps 50,000 to 100,000 AF of effective rainfall would fall in the IID water service area. However, rainfall is not evenly distributed throughout the IID water service area and is not taken into account by IID in the submittal of its Estimate of Diversion (annual water order) to the USBR.

## **EXPECTED WATER AVAILABILITY – SINGLE DRY AND MULTIPLE DRY YEARS**

Historically, when drought conditions exist within the IID water service area, as has been the case for the past two decades, the water supply available to meet agricultural and non-agricultural water demands remains the same as normal year water supply because IID historically relied solely on its entitlement for Colorado River water. Due to the priority of IID water rights and other agreements, drought conditions affecting Colorado River water supplies cause shortages for Arizona, Nevada and Mexico, before impacting California and IID. Accordingly, the Net Available for Consumptive Use volumes in 2023 is 23,020 AF, Column 11 represents the water supply at Imperial Dam available for diversion by IID in single-dry year and multiple-dry year scenarios, consistent with IID’s senior water rights. The runoff declines in the upper basin and prolonged drought conditions throughout the west have resulted, for the first time, in the Colorado River operating under a Tier 2a Shortage Condition in 2023, creating long-term water supply uncertainties throughout the Basin states.

### **Water Management under a Suspended Inadvertant Overrun Payback Policy (IOPP)**

Under normal operating conditions, the CRWDA Inadvertent Overrun Payback Policy (IOPP), provided IID with some flexibility to manage its water use. When the water level in Lake Mead is above 1,125 feet, an overrun of its USBR approved annual water order was permissible, and IID had up to three years to pay water use above the annual water order. When Lake Mead’s water level is at or below 1,125 feet on January 1 in the calendar year after the overrun is reported in the USBR Lower Colorado Region Decree Accounting Report, the IOPP prohibits additional overruns and requires that outstanding overruns be paid back in the subsequent calendar year rather than in three years as allowed under normal conditions; that is, the payback is to be made in the calendar year following publication of the overrun in the USBR Decree Accounting Report. The IOPP is suspended during shortage conditions. For historic IID annual rainfall, net consumptive use, transfers and IID underrun/overrun amounts, see **Table 12**.

**Table 12. IID Annual Rainfall (In), Net Consumptive Use and Underrun/Overrun Amounts (AF), 1988-2021**

Year	IID Total Annual Rainfall	IID Water Users	IID/MWD Transfer	IID/SDCWA Transfer	SDCWA Transfer Salton Sea Mitigation	IID Underrun / Overrun	IID/CVWD Transfer	AAC Lining
1988		2,947,581						
1989		3,009,451						
1990	91,104	3,054,188	6,110					
1991	192,671	2,898,963	26,700					
1992	375,955	2,575,659	33,929					
1993	288,081	2,772,148	54,830					
1994	137,226	3,048,076	72,870					
1995	159,189	3,070,582	74,570					
1996	78,507	3,159,609	90,880					
1997	64,407	3,158,486	97,740					
1998	100,092	3,101,548	107,160					
1999	67,854	3,088,980	108,500					
2000	29,642	3,112,770	109,460					
2001	12,850	3,089,911	106,880					
2002	12,850	3,152,984	104,940					
2003	116,232	2,978,223	105,130	10,000	0	6,555		
2004	199,358	2,743,909	101,900	20,000	15,000	-166,408		
2005	202,983	2,756,846	101,940	30,000	15,000	-159,881		
2006	19,893	2,909,680	101,160	40,000	20,000	12,414		
2007	64,580	2,872,754	105,000	50,000	25,021	6,358		
2008	63,124	2,825,116	105,000	50,000	26,085	-47,999	4,000	8,898
2009	30,0354	2,566,713	105,000	60,000	30,158	-237,767	8,000	65,577
2010	189,566	2,545,593	105,000	70,000	33,736	-207,925	12,000	67,700
2011	109,703	2,915,784	103,940	63,278	0	82,662	16,000	67,700
2012	133,526	2,903,216	104,140	106,722	15,182	134,076	21,000	67,700
2013	134,497	2,554,845	105,000	100,000	71,398	-64,981	26,000	67,700
2014	53,517	2,533,414	104,100	100,000	89,168	-797	31,000	67,700
2015	97,039	2,480,933	107,820	100,000	153,327	-90,025	36,000	67,700
2016	90,586	2,504,258	105,000	100,000	130,796	-62,497	41,000	67,700
2017	105,919	2,548,171	105,000	100,000	105,311	-30,591	45,000	67,700
2018	63,318	2,625,422	105,000	130,000	0	0	63,000	67,700
2019	146,384	2,558,136	105,000	160,000	46,555	-34,215	68,000	67,700
2020	130,275	2,493,623	105,000	192,500	0	-98,073	73,000	67,700
2021	81,901	2,552,674	105,000	205,000	0	-37,737	78,000	67,700
2022	61,377	2,577,164	105,000	202,500	0	-2,299	83,000	67,700

Notes: Volumes in acre-feet and except Total Annual Rainfall are USBR Decree Accounting Report record at Imperial Dam.

IID Total Annual Rainfall from IID Provisional Water Balance, first available calculations are for 1990

Not all IID QSA programs are shown on this table.

Source: [USBR Decree Accounting reports](#), except IID Total Rainfall and IID Overrun/Underrun is a separate calculation

Source: [2021 IID Annual Water & QSA Implementation Report](#) and [2022 IID SWRCB Report](#); IID Total Rainfall and IID Overrun/Underrun is a separate calculation

On August 16, 2021, the water level in Lake Mead was 1,060 feet and for the first time since the IOPP came into effect, the Secretary of the Interior declared the first-ever, Tier 1 shortage condition for Colorado River operations, elevations reaching 1,045 as of mid 2022 (Figure 7). For IID, this meant that no overruns would be allowed to IID’s approved water order.

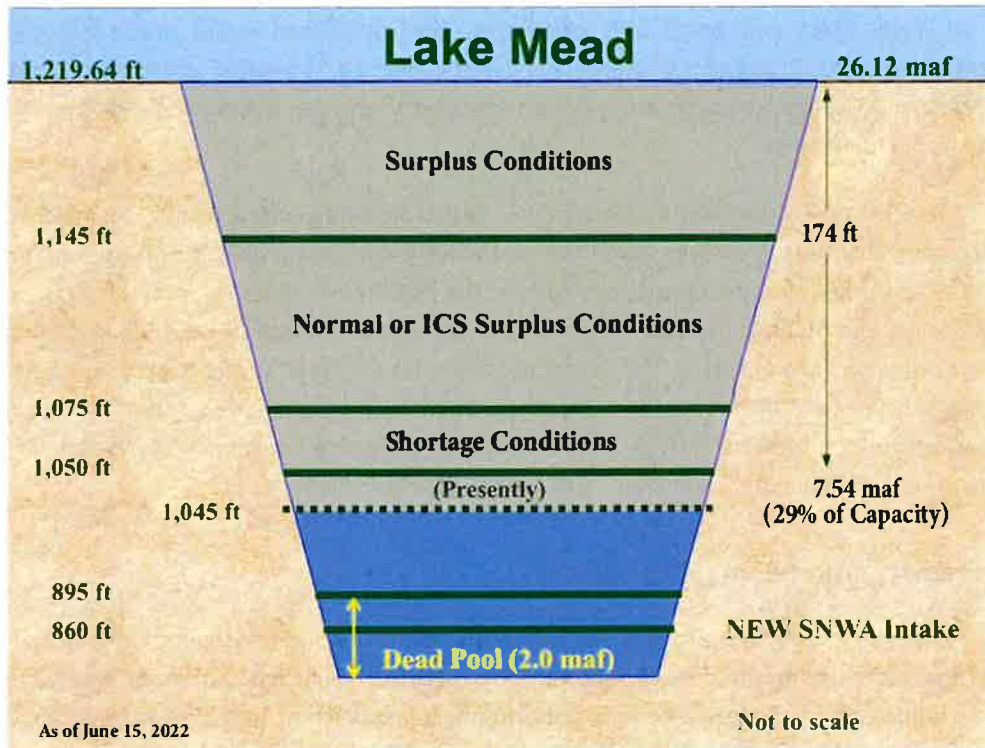

Figure 7. Lake Mead Schematic (June 15, 2022)

The flexibility that IID was allowed in 2013 and 2014 is no longer available to the district. Under the terms of the IOPP, no overruns are allowed in a year when payback is required. IID has not experienced any overrun pay back since 2014 as noted in Table 13. Under shortage conditions, IID would use any conserved water stored in a non-System reservoir, if available, to prevent any overrun.

Table 13. IID Inadvertent Overrun Payback to the Colorado River under the IOPP, 2013-2022

Calendar Year of Payback	2011 Overrun Payback (AF)	2012 Overrun Payback (AF)	Payback Total for Calendar Year (AF)
2013	55,710	-	55,710
2014	20,662	134,076	154,738
<b>Total Payback</b>	<b>76,372</b>	<b>134,076</b>	<b>210,448</b>

Notes: All values are consumptive use volumes at Imperial Dam (AF).

2013 Payback Total was 62 KAF, but in 2012 IID had 6,290 AF of early payback, reducing volume to 55,710 AF

The 2013 IOPP payback obligation, prohibition on overruns in payback years, and suspension of this flexibility during shortage conditions led the IID Board to implement an apportionment program pursuant to the 2007 EDP, which has been subsequently revised and modified over the years. The Revised 2022 EDP is a version approved and adopted by the IID Board on June 21, 2022 (see Attachment B). The Revised 2022 EDP also establishes a water exchange clearinghouse to facilitate the movement of water supply between all water users and water user categories. The established water user categories are 1) agricultural water users, 2) industrial/commercial water users and 3) potable water users. As designed, the clearinghouse will allow IID and its water customers to balance water demands with the water supplies that are available to all users.

Generally, the EDP Apportionment, as discussed in the preceding section, is not expected to impact industrial/commercial uses. However, given the certainty of continuing drought on the Colorado River through 2026 and other stressors, provisions such as the 2012 IWSP Water Agreement sections 3.7 and 3.8 as well for dry and multiple dry year water assessment may come into effect. IID has agreed to work with Project proponents to ensure to the extent possible that the IWSP Water Supply Agreement terms will not adversely impact Project operation. For purposes of this WSA, years with a shortage condition that impacts non-agricultural projects such as an IOPP payback obligation constitute “dry” years for IID. For single-dry year and multiple-dry water year assessments, IID’s EDP shall govern.

### **Equitable Distribution Plan (EDP) History**

A 2006 study by Hanemann and Brookes suggested that overrun conditions were likely to occur 40-50 percent of the years during the decade following the report. Under such conditions a supply/demand imbalance would occur resulting in a need to apportion water consistent with state law. Under California state law, water must be distributed equitably as determined by the IID Board of Directors.

On November 28, 2006, the IID Board of Directors adopted Resolution No 22-2006 approving development and implementation of an Equitable Distribution Plan to address times when customers’ demand would exceed IID’s Colorado River supply. The EDP, adopted in 2007 allowed the IID Board to institute an apportionment program. As part of this resolution, the IID Board directed the General Manager to prepare the rules and regulations necessary or appropriate to implement the plan within the district. The EDP Regulations were created to enable IID to implement a water management tool (apportionment) to address years in which water demand is expected to exceed supply.

It was expected that an annual EDP Apportionment would be established for each of the next several years, if not for the duration of the QSA. However, the implementation of the EDP apportionment was legally challenged in 2013 with litigation ensuing through 2017 when a statement of decision was issued by the trial court, followed by a writ of mandate and a declaratory judgment later that year. The writ of mandate directed IID to repeal the EDP. On February 6, 2018, the IID board approved a resolution repealing the EDP while the case was on appeal. On July 16, 2020, the appellate court reversed the writ of mandate and declaratory judgment on almost all grounds, including declaratory relief on the water rights issue and IID’s discretion to determine the method of apportionment except for a provision as to how water was prioritized



among water user categories. The court ruled that the district is required to distribute water equitably for all categories of users.

On June 21, 2022, IID adopted a revised EDP to address the single outstanding legal issue with respect to prioritization of apportionments among categories of water users. The revised EDP also updated certain operational provisions and most importantly, to the extent feasible, provides for a defined quantity of available, annual water supply apportioned to each water user to prevent cumulative demands from exceeding IID's available, authorized annual Colorado River supply (Appendix B-Equitable Distribution Plan). Implementation of the EDP will resume January 1, 2023 and continue annually thereafter consistent with the adopted EDP. For details regarding the EDP and its implementation, including related forms, please visit IID's website at [Equitable Distribution | Imperial Irrigation District \(iid.com\)](https://www.iid.com).

### **Projected Water Supplies**

The projected and continued decline in runoff and prolonged drought conditions in the West are expected to contribute to even lower water elevation levels at Lakes Powell and Mead. The Department of the Interior made the decision in early 2022 to protect critical Lake Powell elevations above Glen Canyon Dam by adding 500,000 AF of water from Flaming Gorge reservoir and temporarily reducing the 2022 annual operational release to Lake Mead by 480,000 AF. These conditions resulted in a reduced water apportionment to most of the Lower Division States and Mexico for 2022, but did not affect IID's water supply for consumptive use.

Despite the Department's extraordinary actions, the hydrological forecasts and reservoir elevations have continued to decline. Basin states have been asked to develop a plan in 2022 to reduce demands by 2-4 million acre-feet per year through 2026 or the Secretary of the Interior would take regulatory action to force these reductions in order to protect the Colorado River system from the prolonged drought conditions and climate change impacts. California reductions, or the potential for regulatory reductions by the Secretary of the Interior remain undefined as of the date of this water supply assessment for the Green Valley Logistics Center.

IID is working diligently with federal agencies and Colorado River contractors to minimize impacts to the local community. In this vein, IID recognizes the need for significant response actions to protect the long-term water supply certainty for the Imperial Valley as the Colorado River operates under these unprecedented conditions. On October 5, 2022 the Colorado River Board of California, in partnership with representatives of the four primary California Section 5 contractors (IID, Palo Verde Irrigation District, Coachella Valley Water District and Metropolitan Water District of Southern California) submitted a letter to the Department of Interior proposing for California to conserve up to an additional 400,000 AF of water in Lake Mead each year, beginning in 2023 and extending through 2026, to assist with stabilizing Colorado River reservoir elevations. IID has gone on record that its share of the California proposal would not exceed 250,000 AFY. IID proposes to conserve its contribution to Lake Mead via system and on-farm efficiency conservation and temporary fallowing.



## **PROJECT WATER AVAILABILITY FOR A 54-YEAR PERIOD TO MEET PROJECTED DEMANDS**

The proposed Project will obtain drinking water from a certified State of California provider. The existing Memory Gardens Cemetery is part of the subject property and has existing water and electrical service from the Imperial Irrigation District. This portion of the cemetery will include memorial improvements, restrooms, and hardscaped walkways and will contain a septic system and leach field in accordance with State and County standards. Water service would be provided from the overall Project's centralized water treatment and distribution system. Raw water for landscaping is currently provided from the IID Dahlia Lateral 8 and such serviced will be continued in the future for irrigation purposes. Water will be needed for the grain elevator system, hay and grain export and container depot, produce/food export, fuel blending/transloading, fueling station including CNG, and general commodities. These portions of the Project would contain a septic system and leach field in accordance with State and County standards and water for the restrooms, fire water and water for operations would be provided from the overall project's centralized water treatment and distribution system. Water for operations would either be provided from the overall project's centralized water treatment and distribution system or with untreated raw water from the IID canal system.. The Project will receive raw water from IID via the Dahlia Lateral 8 and treat said raw water to potable standards for distribution to all Project elements which will procure their own respective quantities of water. Conversely, if potable treatment and distribution throughout the Project is cost prohibitive, individual users of the Project may address potable water by other means e.g., truck in potable water, individual user treatment facilities, etc. The Project will also have its own dedicated raw water line for access to bulk process water from IID

Untreated Colorado River water will be supplied to the project via the adjacent IID Dahlia Lateral 8 under a(n) Industrial Water Supply Agreement with IID. The Project site contains existing agricultural operations, including approximately 120 acres of recently harvested wheat that is planted and harvested as a rotation crop between other crops. The Project has an existing mainline switch on the Union Pacific Railroad and approximately 0.5 mile of on-site track. The Project site has vacant areas that have previously been farmed and the existing Memory Gardens Cemetery. Over the last 10 years, the Project site has consumed approximately 630 acre-feet per year (AFY) of water for agricultural purposes. Mesquite Lake Specific Plan is located north, east, and south of the Project site, with agricultural land uses and equipment dealerships and other businesses located west of the Project site. North of the site is vacant, disturbed land, followed by a sugar manufacturing facility. East of the site is the UPRR, followed by agricultural fields. South of the site are agricultural fields as well as a property with a CUP for the development of a fertilizer terminal. A mix of agricultural fields and manufacturing uses, including Bakersfield Pipe Supply, RDO Farm Equipment, Empire Construction Machine Rental, and Rain for Rent, are located west of the Project site. The nearest single-family home is located approximately 0.25 mile east of the Project site. On site water use will decrease with implementation of the proposed Project.

As noted previously, under the terms of California legislation adopted to facilitate the QSA/Transfer Agreements and enacted in [CWC Section 1013](#), the IID board adopted the [TLCFP](#) to address how to deal with any such temporary reduction of water use by projects such as solar projects that are developed under a CUP.

While conserved water generated from the TLCFP is limited by law for use for water transfer or environmental purposes, by satisfying multiple district objectives the TLCFP serves to reduce the need for efficiency conservation and other water use reduction practices on the part of IID and its water users providing the district with wide benefits. One of the considerations in developing the TLCFP was to provide agricultural land owners with long-term assurances from IID that, at Project termination, irrigation service would be available for them to resume farming operations.

### IWSP Water

At the present time, IID is providing water delivery service for use by solar energy generation projects under Water Rate [Schedule 7 General Industrial Use](#). If IID determines that the proposed Project should obtain water under IID's Interim Water Supply Policy (IWSP) for non-agricultural projects in addition to delivery rates under [Schedule 7 General Industrial Use](#), the Applicant may need to initiate the process to secure a water supply agreement. IID will determine whether the Project should obtain water under IID's Interim Water Supply Policy (IWSP) for non-agricultural projects in addition to Schedule 7 General Industrial Water.

The IWSP, provided herein as Attachment A, designates up to 25,000 AFY of water for potential Non-Agricultural Projects within IID's water service area. As of **January 2023, IID has up to 23,020 AF** that it may make available under the IWSP for new projects such as the proposed project. The IWSP establishes a schedule for Processing Fees, Reservation Fees, and Connection Fees that change each year for all non-agricultural projects, and annual Water Supply Development fees for some non-agricultural projects. The proposed Project's water use will be subject to the annual Water Supply Development fee if IID determines that water for the Project is to be supplied under the IWSP.

Given the Colorado River conditions, the likelihood that IID will not receive its annual 3.1 MAF apportionment less QSA/Transfer Agreement obligations of Colorado River water is no longer low despite the high priority of the IID entitlement relative to other Colorado River contractors, see IID's Water Rights section on **page 22** and projected water supplies. Given the prolonged drought conditions and recent communication from the Department of the Interior, reductions to all basin contractors, including IID, are increasingly likely. If such obligatory reductions were to come into effect within the 20-year Project life, the Applicants are to work with IID to ensure any anticipated reduction can be managed.

The County of Imperial as the lead agency has a responsibility to determine if the current and projected demands and water supply conditions, including projected uncertainties of Colorado River hydrology are sufficient to enable the County to make the findings necessary to approve this WSA. IID, like any water

provider, has jurisdiction to manage the water supply within its service area and impose conservation measures during a period of temporary water shortage, such as the one we are experiencing now.

Furthermore, without the proposed Project's replacement of agricultural land with the Green Valley Logistics Center, IID's task of managing water supply under the QSA/Transfer Agreements and any other voluntary contributions to Lake Mead would be more difficult, because agricultural water use on the proposed Project site would be significantly higher than the proposed water demand for the proposed Project as explained in the Expected Water Demands for the Proposed Project on the section that follows.

Water for construction (primarily for dust control) would be obtained from IID canals or laterals in conformance with IID rules and regulations for MCI temporary water use.<sup>20</sup> Water would be picked up from a nearby canal or lateral and delivered to the construction location by a water truck capable of carrying approximately 4,000 gallons per load. To obtain water delivery service, the Project proponent will complete an [IID-410 Certificate of Ownership and Authorization](#) (Water Card), which allows the Water Department to provide the district with information needed to manage the district apportioned water supply. Water cards are used for Agriculture, Municipal, Industrial and Service Pipe accounts. If water is to be provided under IWSP in addition to Schedule 7. General Industrial Use, the Applicant may also need to enter into a IWSP Water Supply Agreement.

---

<sup>20</sup> Complete the Application for Temporary Water Use and submit to Division office. Complete encroachment permit through Real Estate – non-refundable application fee of \$250, see IID website: [Real Estate / Encroachments, Permissions, and Other Permitting](#). Fee for temporary service water: Schedule No. 7 General Industrial Use / Temporary Service Minimum charge for up to 5 AF, pay full flat fee for 5 AF at General Industrial Use rate (\$425); use more than 5 AF, pay fee for actual use at General Industrial Rate (\$85/AF).

## EXPECTED WATER DEMANDS FOR THE PROPOSED PROJECT

Water for the proposed Project will be needed on-site for Project construction, operation of the existing cemetery and memorial, the grain elevator system, hay and grain export and container depot, produce/food export, fuel blending/transloading, fueling station, and general commodities. Water will also be needed for decommissioning. Untreated Colorado River water will be supplied to the project via the adjacent IID Dahlia Lateral 8 under a(n) Industrial water agreement with IID. The Project site contains existing agricultural operations, including approximately 120 acres of recently harvested wheat that is planted and harvested as a rotation crop between other crops as well as approximately 84 acres that has been periodically farmed and is currently growing sudan grass. The Project has an existing mainline switch on the Union Pacific Railroad and approximately 0.5 mile of on-site track. The Project site has vacant areas that have previously been farmed and the existing Memory Gardens Cemetery. Over the last 10 years, the Project site has consumed approximately 630 acre-feet per year (AFY) of water for agricultural purposes. The proposed Project would require 180 AFY of water or a net decrease of 450 AFY when compared to the Project area’s historical annual water consumption from IID via the Dahlia Lateral 8.

Project raw water uses are summarized in **Table 14**.

**Table 14. Project Operational Water Uses (AFY)**

Use	Acre-Feet per Year
Raw Water for Dust Control*	0
Existing Cemetery and Memorial Area	50
Grain Elevator System	20
Hay and Grain Export and Container Depot	30
Produce / Food Export	25
Fuel Blending / Transloading	15
Fueling Station Including CNG	10
General Commodities: Transloading/Warehouse	30
<b>TOTAL RAW WATER USAGE</b>	<b>180</b>

\* *Water for Dust Control included in uses below.*

IID delivers untreated Colorado River water to the proposed Project site for agricultural uses through the following gates and laterals. The 10-year record for 2013-2022 of water delivery accounting is shown in **Table 15**. The data documents a 10-year of 1,708 AFY average.

**Table 15. Ten-Year Historic Delivery (AFY), 2012-2021**

Canal/Gate	2013	2014	2015	2016	2017	2018	2019	2020	2021	2022
Dahlia Lateral 8 Gate 62	320.5	231.8	426.2	375.9	371.5	278.9	269.2	355.9	351.8	348.2
Dahlia Lateral 8 Gate 63	725.9	917.0	586.4	426.1	396.5	215.3	802.6	726.8	634.9	308.7
Dahlia Lateral 8 Gate 65	763.4	780.2	733.5	919.7	840.7	707.3	816.2	838.4	802.4	811.3
<b>TOTAL</b>	<b>1,809.8</b>	<b>1,929</b>	<b>1,746.1</b>	<b>1,721.7</b>	<b>1,608.7</b>	<b>1,201.5</b>	<b>1,888.0</b>	<b>1,921.1</b>	<b>1,789.1</b>	<b>1,468.2</b>

Source: IID Staff, 2023 (Contact Justina Gamboa-Arce)

The proposed Project has an estimated total operational water demand of 180 AFY. The proposed Project demand is a decrease of 1,528 AFY from the historical 10-year average or 89 percent (89 %) less than the historic 10-year average annual delivery for agricultural uses at the proposed Project site. The proposed Project's estimated operational water demand represents only 1 percent (1%) of the 23,020 AYF balance of water supply that may be available for contracting under the IWSP.



## IID’S ABILITY TO MEET DEMANDS WITH WATER SUPPLY

Under normal operating conditions, non-agricultural water demands for the IID water service area are projected for 2025-2055 in **Table 5**, and IID agricultural demands including system operation are projected for 2025-2055 in **Table 6**, all volumes within the IID water service area. IID water supplies available for consumptive use after accounting for mandatory transfers are projected to 2077 in **Table 11** (Column 11), volumes at Imperial Dam.

To assess IID’s ability to meet future water demands, IID historic and forecasted demands are compared with CRWDA Exhibit B net availability under its water supply entitlement, volumes at Imperial Dam **Table 11** (Column 11). The analysis requires accounting for system operation consumptive use within the IID water service area, from AAC at Mesa Lateral 5 to Imperial Dam, and for water pumped for use by the USBR Lower Colorado Water Supply Project (LCRWSP), an IID consumptive use component in the USBR Decree Accounting Report. IID system operation consumptive use for 2021 is provided in **Table 16** to show the components to be included in the calculation of 2021 volumes in comparison to 2020.

**Table 16. IID System Operations Consumptive Use within IID Water Service Area and from AAC at Mesa Lateral 5 to Imperial Dam, (KAF), 2022**

	2020 Operational Consumptive Use (KAF)	2022 Operational Consumptive Use (KAF)
IID Delivery System Evaporation	24.4	24.8
IID Canal Seepage	90.8	89.4
IID Main Canal Spill	10.1	10.6
IID Lateral Canal Spill	121.5	122.4
IID Seepage Interception	-39.0	-33.8
IID Unaccounted Canal Water	-40.0	-161.4
<b>Total IID System Operational Use, within water service area</b>	<b>167.8</b>	<b>52.0</b>
“Losses” from AAC @ Mesa Lat 5 to Imperial Dam	9.2	44.2
LCWSP pumpage	-10	-10
<b>Total System Operational Use in 2020 and 2022</b>	<b>167.0</b>	<b>86.2</b>

Sources: 2022 IID Water Balance Rerun 03/28/2023

Notwithstanding and regulatory water supply cuts from the Secretary of Interior, IID’s ability to meet customer water demands through 2055 as shown in **Table 17** is based on the following:

- Non-agricultural use from **Table 5**.
- Agricultural and Salton Sea mitigation uses from **Table 6**.
- CRWDA Exhibit B net available for IID consumptive use from **Table 17**.
- System operation consumptive use from **Table 16** for 2020

**Table 17. IID Historic and Forecasted Consumptive Use vs CRWDA Exhibit B IID Net Available Consumptive Use, volumes at Imperial Dam (KAFY), 2015-2055 Next Update in 2026 thru 2025**

	2015	2020	2025	2030	2035	2040	2045	2050	2055
Non-Ag Delivery	110.1	113.2	133.1	142.9	151.4	163.2	175.4	188.4	199.3
Ag Delivery	2,156.8	2,165.4	2,259.5	2,209.5	2,209.5	2,209.5	2,209.5	2,209.5	2,209.5
QSA SS Mitigation Delivery	153.3	0.0	0.0	0.0	0.0	0.0	0.0	0.0	0.0
System Op CU in IID & to Imperial Dam	220.2	167.0	230.5	225.4	225.4	225.4	225.4	225.4	225.4
<b>IID CU at Imperial Dam</b>	<b>2,480.9</b>	<b>2,493.7</b>	<b>2,623.1</b>	<b>2,577.8</b>	<b>2,586.3</b>	<b>2,598.1</b>	<b>2,610.3</b>	<b>2,623.3</b>	<b>2,634.2</b>
<b>Exhibit B IID Net Available for CU at Imperial Dam</b>	<b>2,480.9</b>	<b>2,652.0</b>	<b>2,617.8</b>	<b>2,612.8</b>	<b>2,612.8</b>	<b>2,612.8</b>	<b>2,612.8</b>	<b>2,665.8</b>	<b>2,665.8</b>
<b>IID Underrun/Overrun at Imperial Dam</b>	<b>-90.0</b>	<b>-98.1</b>	<b>-5.30</b>	<b>35.00</b>	<b>26.50</b>	<b>14.70</b>	<b>2.50</b>	<b>42.50</b>	<b>31.60</b>

Notes: 2015 Provisional Water Balance and 2020 Provisional Water Balance run on 1/25/21

Non-Ag Delivery CI 15.0%, Ag Delivery CI 3.0%, QSA SS mitigation CI 15%

QSA Salton Sea Mitigation Delivery terminated on 12/31/2017

Underrun /Overrun = IID CU at Imperial Dam minus CRWDA Exhibit B Net Available

Notes: Ag Delivery for 2020-2055 does not take into account land conversion for solar use nor reduction in agricultural land area due to urban expansion.

As shown above, IID forecasted demand has the potential to exceed CRWDA Exhibit B Net Consumptive Use volumes during several time intervals through the lifespan projection for the Project. However, due to temporary land conversion for solar use and urban land expansion that will reduce agricultural acres in the future, a water savings of approximately 217,000 AFY will likely be generated into the future and for the lifetime of the proposed Project.

In addition, USBR 2020 Decree Accounting Report states that IID Consumptive Use was 2,493.7 KAF (excludes 1,579 AF of ICS for storage in Lake Mead and an additional 49,444 AF of conserved water left on the Colorado River system) with an underrun of -98.1 KAF, as reported by IID in [2020 Annual SWRCB Report per WRO 2002-2013](#); that is, IID uses less than the amount in its approved Water Order (2,615,300 AF).

**Table 18. 2020 Approved Water Order, Actual CU (Decree Accounting Report) and IID Underrun, KAF at Imperial Dam**

IID Approved Water Order	2,625.3 less 10 supplied by LCWSP and less 26 of additional conserved water
IID Consumptive Use	2,493.7
IID Underrun /Overrun	-98.1

Sources:

2020 IID Revised Water Order, approved on March 10, 2020, [2020 Decree Accounting Report](#), and [2020 Annual Report of IID Pursuant to SWRCB Revised Order WRO 2002-2013](#)

As reported in the [2021 Annual Water & QSA Implementation Report](#) and [2022 SWRCB Report](#) and presented in **Table 12**, from 2013 to 2021 IID consumptive use (CU) resulted in underruns; i.e., annual CU was less than the district's QSA Entitlement of 3.1 MAFY minus QSA/Transfer Agreements obligations. This would indicate that even though **Table 17** shows IID Overrun/Underrun at Imperial Dam exceeding CRWDA Exhibit B Net Available for CU, for the 54-year life of the proposed Project, IID consumptive use may be less than forecasted.

Meanwhile, forecasted Ag Delivery reductions presented in **Table 6** are premised on implementation of on-farm practices that will result in efficiency conservation. These reductions do not take into account land conversion for solar projects nor reduction in agricultural land area due to urban expansion; that is to say, the forecasted Ag Delivery is for acreage in 2003 with reduction for projected on-farm conservation efficiency. Thus, Ag Delivery demand may well be less than forecasted in **Table 6**. In any case, the proposed Project will use less water than the historical agricultural demand of proposed Project site, so the proposed Project will ease rather than exacerbate overall IID water demands.

In the event that IID has issued water supply agreements that exhaust the 25 KAFY IWSP set aside, and it becomes apparent that IID delivery demands due to non-agriculture use are going to cause the district to exceed its quantified 3.1 MAFY entitlement less QSA/Transfer Agreements obligations, IID has identified options to meet these new non-agricultural demands. These options include (1) tracking water yield from temporary land conversion from agricultural to non-agricultural land uses (renewable solar energy); and (2) only if necessary, developing conservation projects to expand the size of the district's water supply portfolio.

These factors will be discussed in the next two sections, Tracking Water Savings from Growth of Non-Agricultural Land Uses and Expanding Water Supply Portfolio.

### **Tracking Water savings from Growth of Non-Agricultural Land Uses**

The Imperial County Board of Supervisors has targeted up to 25,000 acres of agricultural lands, about 5 percent (5%) of the farmable acreage served by IID, for temporary conversion to solar farms; because the board found that this level of reduction would not adversely affect agricultural production. As reported for IID's [Temporary Land Conversion Following Program](#), existing solar developments at the end of 2022 have converted 13,177 acres of farmland. Solar projects had a total yield at-river of 69,898 AF of water in 2022. The balance of the 25,000-acre agriculture-to-solar policy is 11,823 acres. On average, each agricultural acre converted reduces agricultural demand by 5.1 AFY, which results in a total at-river yield (reduction in consumptive use) of 127,500 AFY.

However, due to the nature of the conditional use permits under which solar farms are developed, IID cannot rely on this supply being permanently available. In fact, should a solar project decommission early, that land may go immediately back to agricultural use (it remains zoned an agricultural land).

Nevertheless, during their operation, the solar farms do ameliorate pressure on IID to implement projects to meet demand from new non-agricultural projects.

Unlike the impact of solar projects, other non-agricultural uses are projected to grow, as reflected in the nearly 53 percent (53%) increase in non-agricultural water demand from 107.4 KAF in 2015 to 201.4 KAF in 2055 reflected herein in Table 5. This increase in demand of 94 KAFY is likely to be offset by reductions in agricultural lands; however, as the land remains zoned as agricultural land, that source is not reliable to be permanently available to IID.

The amount of land developed for residential, commercial, and industrial purposes is projected to grow by 55,733 acres from 2015 to 2050<sup>21</sup> within the sphere of influence of the incorporated cities and specific plan areas in Imperial County. A conservative estimate is that such development will displace at least another 24,500 acres of farmland based on the Imperial Local Agency Formation Commission (LAFCO) sphere of influence maps and existing zoning and land use in Imperial County. At 5.13 AFY yield at-river, there would be a 125,000 AFY reduction IID net consumptive use. However, the total acreage from actual annexations that have resulted in reductions to agricultural acreage between 2015 and 2021 has been 2,224 acres, according to IID's annual inventory of total farmable land which is consistent with the acreage gain to non-agricultural land uses (2,224 acres) and based off of annexation records obtained through the Imperial County Local Agency Formation Commission. This shift in acreage documents a growth rate of approximately 50 percent of the originally projected rate.

The total foreseeable solar project temporary yield at-river (91,800 AFY) and municipal development permanent yield at-river, conservatively adjusted (65,000 AFY) is to reduce forecasted IID net consumptive use at-river 156,800 AFY, which is more than enough to meet the forecast Demand minus Exhibit B Net Available volumes shown in **Table 10**. This Yield at-river is sufficient to meet the forecasted excess of non-agricultural use over Net Available supply within the IID service area for the next 20 years, as is required for SB 610 analysis (assuming there are no regulatory cuts to IID's full entitlement).

Farmland retirement associated with municipal development would reduce IID agricultural delivery requirements beyond the efficiency conservation projections shown in **Table 6** and **Table 17**. Therefore, in the event that Schedule 7 General Industrial Use water has exhausted its apportioned amount, the Applicants will rely on IID IWSP water to supply the Project, as discussed above in the Projected Water Availability section.

## Expanding Water Supply Portfolio

While forecasted long-term annual yield-at-river from the reduction in agricultural acreage due to municipal development in the IID service area is sufficient to meet the forecasted excess of non-agricultural use over CRWDA Net Available supply (**Table 11**) without regulatory cuts and without

---

<sup>21</sup> IRWMP, Chapter 5, Table 5-14.

expanding IID's Water Supply Portfolio, IID has also evaluated the feasibility of a number of capital projects to increase its water supply portfolio.

As reported in [2012 Imperial IRWMP Chapter 12](#), IID contracted with GEI Consultants, Inc. to identify a range of capital project alternatives that the district could implement. Qualitative and quantitative screening criteria and assumptions were developed in consultation with IID staff. Locations within the IID water service area with physical, geographical, and environmental characteristics most suited to implementing short- and long-term alternatives were identified. Technical project evaluation criteria included volumes of water that could be delivered and/or stored by each project, regulatory and permitting complexity, preliminary engineering components, land use requirements, and costs.

After preliminary evaluation, a total of 27 projects were configured:

- 17 groundwater or drain water desalination
- 2 groundwater blending
- 6 recycled water
- 1 groundwater banking
- 1 IID system conservation (concrete lining)

Projects were assessed at a reconnaissance level to allow for comparison of project costs. IID staff and the board identified key factors to categorize project alternatives and establish priorities. Lower priority projects were less feasible due to technical, political, or financial constraints. Preferential criteria were features that increased the relative benefits of a project and grant it a higher priority. Four criteria were used to prioritize the IID capital projects:

1. **Financial Feasibility.** Projects whose unit cost was more than \$600/AF were eliminated from further consideration.
2. **Annual Yield.** Project alternatives generating 5,000 AF or less of total annual yield were determined not to be cost-effective and lacking necessary economies of scale.
3. **Groundwater Banking.** Groundwater banking to capture and store underruns is recognized as a beneficial use of Colorado River water. Project alternatives without groundwater banking were given a lower priority.
4. **Partnering.** Project alternatives in which IID was dependent on others (private and/or public agencies) for implementation were considered to have a lower priority in the IID review; this criterion was reserved for the IRWMP process, where partnering is a desirable attribute.

Based on these criteria, the top ten included six desalination, two groundwater blending, one system conservation, and one groundwater storage capital projects. These capital projects are listed in Table 9 which follows.



**Table 19. IID Capital Project Alternatives and Cost (May 2009 price levels \$)**

Name	Description	Capital Cost	O&M Cost	Equivalent Annual Cost	Unit Cost (\$/AF)	In-Valley Yield (AF)
GW 18	Groundwater Blending E. Mesa Well Field Pumping to AAC	\$39,501,517	\$198,000	\$2,482,000	\$99	25,000
GW 19	Groundwater Blending: E. Mesa Well Field Pumping to AAC w/Percolation Ponds	\$48,605,551	\$243,000	\$3,054,000	\$122	25,000
WB 1	Coachella Valley Groundwater Storage	\$92,200,000	\$7,544,000	\$5,736,746	\$266	50,000
DES 8	E. Brawley Desalination with Well Field and Groundwater Recharge	\$100,991,177	\$6,166,000	\$12,006,000	\$480	25,000
AWC 1	IID System Conservation Projects	\$56,225,000	N/A	\$4,068,000	\$504	8,000
DES 12	East Mesa Desalination with Well Field and Groundwater Recharge	\$112,318,224	\$6,336,000	\$12,831,000	\$513	25,000
DES 4	Keystone Desalination with IID Drainwater/ Alamo River	\$147,437,743	\$15,323,901	\$23,849,901	\$477	50,000
DES 14	So. Salton Sea Desalination with Alamo River Water and Industrial Distribution	\$158,619,378	\$15,491,901	\$24,664,901	\$493	50,000
DES 15	So. Salton Sea Desalination with Alamo River Water and MCI Distribution	\$182,975,327	\$15,857,901	\$26,438,901	\$529	50,000
DES 2	Keystone Desalination with Well Field and Groundwater Recharge	\$282,399,468	\$13,158,000	\$29,489,000	\$590	50,000

Source: Imperial IRWMP, Chapter 12; see also Imperial IRWMP Appendix N, IID Capital Projects

## IID Near Term Water Supply Projections

As mentioned above, IID’s quantified Priority 3(a) water right under the QSA/Transfer Agreements secures 3.1 MAF per year, less transfer obligations of water for IID’s use from the Colorado River, without relying on rainfall in the IID service area. Even with this strong entitlement to water, IID actively promotes on-farm efficiency conservation and is implementing system efficiency conservation measures including seepage recovery from IID canals and the All-American Canal (ACC) and measures to reduce operational discharge. As the IID website [Water Department](#) states:

Through the implementation of extraordinary conservation projects, the development of innovative efficiency measures and the utilization of progressive management tools, the IID Water Department is working to ensure both the long-term viability of agriculture and the continued protection of water resources within its service area.

Overall, agricultural water demand in the Imperial Valley will decrease due to IID system and grower on-farm efficiency conservation measures that are designed to maintain agricultural productivity at pre-QSA levels while producing sufficient yield-at-river to meet IID’s QSA/Transfer Agreements obligations. These efficiencies combined with the conversion of some agricultural land uses to non-agricultural land uses (both solar and municipal), ensure that IID can continue to meet the water delivery demand of its

existing and future agricultural and non-agricultural water users, including this Project for the next 54 years and for the life of the proposed Project under a water supply consistent with the district's full entitlement.

## IMPERIAL COUNTY PLANNING AND DEVELOPMENTAL SERVICES (LEAD AGENCY) FINDINGS

IID serves as the regional wholesale water supplier, importing raw Colorado River water and delivering it, untreated, to agricultural, municipal, industrial, environmental and recreational water users within its water service area. Imperial County Planning and Development Services serves as the responsible agency with land use authority over the proposed project. Imperial County Planning and Development Services Water Assessment findings are summarized as follows, based on the information contained herein and as supported by IID water supply data:

1. IID's annual entitlement to consumptive use of Colorado River water is capped at 3.1 MAF less water transfer obligations, pursuant to the QSA and Related Agreements. Under the terms of the CRWDA, IID is implementing efficiency conservation measure to reduce net consumptive use of Colorado River water needed to meet its QSA/Transfer Agreements obligations while retaining historical levels of agricultural productivity.
2. In 2022 IID consumptively used 2,557,164 AF of Colorado River water (volume at Imperial Dam); 2,486,061 AF were delivered to customers (including recreational and environmental water deliveries) of which 2,368,642 AF or 95 percent went to agricultural users as per IID's Water Balance run on 3/30/2023.
3. Reduction of IID's net consumptive use of Colorado River water under the terms of the Colorado River Water Delivery Agreement is to be the result of efficiency conservation measures. Crop water use in the Imperial Valley will not decline under these conditions, however IID operational spill and tailwater from field runoff will decline as efficiency conservation measures are implemented, impacting the Salton Sea.
4. The dependability of IID's water rights, Colorado River flows, and Colorado River storage facilities for Colorado River water alone are not sufficient to assure water availability for the Project. The prolonged drought conditions on the Colorado River Basin have made it increasingly likely that the water supply of IID may be disrupted, in dry years or/and under shortage conditions. Mexico, Arizona and Nevada, which have lower priority than IID, have already experienced Tier 1 and Tier 2a reductions in 2022 as a result of the declared Colorado River water shortage.
5. Due to ongoing Colorado River drought conditions, Lake Mead's declining elevation, reduced inflows from Lake Powell, and the suspension of the federal Inadvertent Overrun and Payback Policy, which eliminates IID's ability to overrun its 3.1 MAF annual entitlement during water shortage conditions, the IID Board has implemented an annual apportionment program (otherwise known as the Equitable Distribution Plan or EDP).
6. IID's EDP apportions the available water supply among all its water users equitably and among three water user categories 1) agricultural water users, 2) commercial/industrial water users, and 3) potable water users. Apportionment into these categories as a whole is initiated after deducting from the available water supply water for operational system needs, system

conservation yields, environmental mitigation requirements, recreational uses, and similar unmeasured small pipe account water uses. See Attachment B -Equitable Distribution Plan.

7. Historically, IID has never been denied the right to use the annual volume of water it has available for its consumptive uses under its entitlement. Nevertheless, IID is participating in discussions for possible actions in response to continued extreme drought on the Colorado River.
  8. The proposed Project has an estimated total water demand 180 AFY. The proposed Project demand is a decrease of 1,528 AFY from the historical 10-year average or 89 percent (89 %), decrease from the historic 10-year average annual delivery for agricultural uses at the proposed Project site.
  9. The Project's water delivery will be covered under the Schedule 7 General Industrial Use. In the event that IID determines that the proposed Project is to utilize IWSP for Non-Agricultural Projects water, the Applicant will also need to enter into an IWSP Water Supply Agreement with IID. In which case, the proposed Project would use 1 percent (1%) of the **23,020 AYF** of IWSP water.
  10. Based on the Initial Study and Mitigated Negative Declaration prepared for this proposed Project pursuant to the CEQA, California Public Resources Code sections 21000, *et seq.* (SCH **No. \_\_\_\_\_**), Imperial County Planning and Development Services hereby finds that the IID projected water supply is sufficient to satisfy the demands of this proposed Project in addition to existing and planned future uses, including agricultural and non-agricultural uses for a 20-year Water Supply Assessment period and for the 54 -year proposed Project life.
-

## ASSESSMENT CONCLUSION

This Water Supply Assessment has determined that IID water supply is adequate for the Green Valley Logistics Center (proposed Project). The Imperial Irrigation District's IWSP for Non-Agricultural Projects dedicates 25,000 AF of IID's annual water supply to serve new projects. As of **January 2022, a total of 23,020** AF per year remain available for new projects providing reasonably sufficient supplies for new non-agricultural water users that enter into a Water Supply Agreement with IID. Imperial County Planning and Development Services estimates a cumulative, non-agricultural project water supply demand of approximately 180 AFY within the foreseeable 54-year planning period.

New, non-agricultural projects may be susceptible to delivery cutbacks when an EDP Apportionment is exhausted, thus all approved projects require best management practices and water use efficiency at all times. Given the prolonged drought conditions and recent communication to IID from the Department of the Interior, reductions to all basin contractors, including IID and its water customers, are increasingly likely. If such reductions were to come into effect within an approved project's 20-year life, the Applicants are to work with IID to ensure any anticipated reduction can be managed.

Under an authorized water supply agreement, the Green Valley Logistics Center will be required to acknowledge and accept as a condition of water service that to the extent that IID receives an order or directive from a governmental authority, having appropriate jurisdiction, that reduces the total volume of water available to IID from the Colorado River during all or any part of their water service agreement, IID may reduce the water service agreement amount, as directed by the IID Board, as a proportionate reduction of the total volume of water available to IID. This reduction is separate from and in addition to any allocation authorized pursuant to the EDP.

The Project's water demand of approximately 180 AFY amortized over 54 years represents less than 1 % of the unallocated supply set aside in the IWSP for non-agricultural project, and approximately 0.001 percent (0.001 %) of forecasted future non-agricultural water demands planned in the Imperial IRWMP through 2055. The water demand for the proposed Project represents a 89 % decrease from the 10-year average historic average agricultural water use for **2013-2022** at the proposed Project site, a decrease in in water use of 450 AFY at full build-out.

For all the reasons described herein, the historical stability of the IID water supply, the amount of foreseeable water available, along with on-farm and system efficiency conservation and other measures being undertaken by IID and its customers suggest that Green Valey Logistics Center 's water needs will be reasonably met for the next 54 years as assessed for compliance under SB-610.





## RESOURCES AND REFERENCES

1. California Department of Water Resources. (2003). [Guidebook for Implementation of Senate Bill 610 and Senate Bill 221 of 2001](#) to assist water suppliers, cities, and counties in integrating water and land use planning.
2. Imperial County Planning and Development Services. (2008). Imperial County General Plan 2008 Update. El Centro, CA. [General Plan | Imperial County Planning & Development Services \(icpds.com\)](#), retrieved, 2021
3. Imperial Irrigation District. Website: [Equitable Distribution Plan](#).
4. Imperial Irrigation District Website: [2021 Water Conservation Plan](#). (2021). Imperial Irrigation District 2021 Water Conservation Plan. Imperial, CA.
5. Imperial Irrigation District. (2023). IID [Interactive GIS Water Service Area Map](#). Imperial, CA.
6. Imperial Irrigation District. (2009). [Interim Water Supply Policy for Non-Agricultural Projects](#). Imperial, CA
7. Imperial Irrigation District. (2012). [Temporary Land Conversion Following Policy \(TLFCP\) for Water Conservation Yield](#) Water conservation yield attributable to land removed from agricultural production and temporarily fallowed. Updated March 27, 2018.
8. Imperial Irrigation District Water Department. (2013). [Colorado River Water Accounting and Conservation Commitments Update](#). Tina Anderholt Shields, PE. Colorado River Resources Manager Imperial, CA.
9. Imperial Irrigation District. (2021). [2021 Water & QSA Implementation Report](#), Imperial, CA
10. Imperial Irrigation District. (2021). Consultation with Justina Gamboa-Arce., Water Conservation Planner. Imperial, CA.
11. Imperial Irrigation District. (2022). [Temporary Land Following Conversion Policy. \(TLFCP\)](#).
12. Imperial Irrigation District. (2022). [2022 IID SWRCB Report](#).
13. United States Bureau of Reclamation Lower Colorado Region Website: [Boulder Canyon Operations Office – Programs and Activities](#), Lower Colorado River Water Accounting, Water Accounting Reports (1964 - 2015). Compilation of Records in Accordance with Article V of the Decree of the Supreme Court of the United States in Arizona v. California Dated March 9, 1964: Calendar Years 1964 - 2015 Boulder City, NV.

**ATTACHMENTS**

## **Attachments**

Attachment A: IID Interim Water Supply Policy for Non-Agricultural Projects

Attachment B: IID 2022 Equitable Distribution Plan, revised June 21, 2022

(This page intentionally left blank)



## **ATTACHMENT A: IID INTERIM WATER SUPPLY POLICY FOR NON-AGRICULTURAL PROJECTS<sup>22</sup>**

### **1.0 Purpose.**

Imperial Irrigation District (the District) is developing an Integrated Water Resources Management Plan (IWRMP) <sup>23</sup> that will identify and recommend potential programs and projects to develop new water supplies and new storage, enhance the reliability of existing supplies, and provide more flexibility for District water department operations, all in order to maintain service levels within the District's existing water service area. The first phase of the IWRMP is scheduled to be completed by the end of 2009 and will identify potential projects, implementation strategies and funding sources. Pending development of the IWRMP, the District is adopting this Interim Water Supply Policy (IWSP) for Non-Agricultural Projects, as defined below, in order to address proposed projects that will rely upon a water supply from the District during the time that the IWRMP is still under development. It is anticipated that this IWSP will be modified and/or superseded to take into consideration policies and data developed by the IWRMP.

### **2.0 Background.**

The IWRMP will enable the District to more effectively manage existing water supplies and to maximize the District's ability to store or create water when the available water supplies exceed the demand for such water. The stored water can be made available for later use when there is a higher water demand. Based upon known pending requests to the District for water supply assessments/verifications and pending applications to the County of Imperial for various Non-Agricultural Projects, the District currently estimates that up to 50,000 acre feet per year (AFY) of water could potentially be requested for Non-Agricultural Projects over the next ten to twenty years. Under the IWRMP the District shall evaluate the projected water demand of such projects and the potential means of supplying that amount of water. This IWSP currently designates up to 25,000 AFY of water for potential Non-Agricultural Projects within IID's water service area. Proposed Non-Agricultural projects may be required to pay a Reservation Fee, further described below. The reserved water shall be available for other users until such Non-Agricultural projects are implemented and require the reserved water supply. This IWSP shall remain in effect pending the approval of further policies that will be adopted in association with the IWRMP.

### **3.0 Terms and Definitions.**

3.1 Agricultural Use. Uses of water for irrigation, crop production and leaching.

---

<sup>22</sup> IID Board Resolution 31-2009. Interim Water Supply Policy for New Non-Agricultural Projects. September 29, 2009. <[IID Interim Water Supply Policy for Non-Agricultural Projects](#)>

<sup>23</sup> The 2009 Draft IID IWRMP has been superseded by the October 2012 Imperial IRWMP, which incorporates the conditions of the IWSP by reference.

3.2 **Connection Fee.** A fee established by the District to physically connect a new Water User to the District water system.

3.3 **Industrial Use.** Uses of water that are not Agricultural or Municipal, as defined herein, such as manufacturing, mining, cooling water supply, energy generation, hydraulic conveyance, gravel washing, fire protection, oil well re-pressurization and industrial process water.

3.4 **Municipal Use.** Uses of water for commercial, institutional, community, military, or public water systems, whether in municipalities or in unincorporated areas of Imperial County.

3.5 **Mixed Use.** Uses of water that involve a combination of Municipal Use and Industrial Use.

3.6 **Non-Agricultural Project.** Any project which has a water use other than Agricultural Use, as defined herein.

3.7 **Processing Fee.** A fee charged by the District Water Department to reimburse the District for staff time required to process a request for water supply for a Non-Agricultural Project.

3.8 **Reservation Fee.** A non-refundable fee charged by the District when an application for water supply for a Non-Agricultural Project is deemed complete and approved. This fee is intended to offset the cost of setting aside the projected water supply for the project during the period commencing from the completion of the application to start-up of construction of the proposed project and/or execution of a water supply agreement. The initial payment of the Reservation Fee will reserve the projected water supply for up to two years. The Reservations Fee is renewable for up to two additional two-year periods upon payment of an additional fee for each renewal.

3.9 **Water Supply Development Fee.** An annual fee charged to some Non-Agricultural Projects by the District, as further described in Section 5.2 herein. Such fees shall assist in funding IWRMP or related water supply projects,

3.10 **Water User.** A person or entity that orders or receives water service from the District.

**4.0. CEQA Compliance.**

4.1 The responsibility for CEQA compliance for new development projects within the unincorporated area of the County of Imperial attaches to the County of Imperial or, if the project is within the boundaries of a municipality, the particular municipality, or if the project is subject to the jurisdiction of another agency, such as the California Energy Commission, the particular agency. The District will coordinate with the County of Imperial, relevant municipality, or other agency to help ensure that the water supply component of their respective general plans is comprehensive and based upon current information. Among other things, the general plans should assess the direct, indirect and cumulative potential impacts on the environment of using currently available water supplies for new industrial, municipal, commercial and/or institutional uses instead of the historical use of that water for agriculture. Such a change in land

use, and the associated water use, could potentially impact land uses, various aquatic and terrestrial species, water quality, air quality and the conditions of drains, rivers and the Salton Sea.

4.2 When determining whether to approve a water supply agreement for any Non-Agricultural Project pursuant to this IWSP, the District will consider whether potential environmental and water supply impacts of such proposed projects have been adequately assessed, appropriate mitigation has been developed and appropriate conditions have been adopted by the relevant land use permitting/approving agencies, before the District approves any water supply agreement for such project.

**5.0. Applicability of Fees for Non-Agricultural Projects.<sup>24</sup>**

5.1 Pursuant to this Interim Water Supply Policy, applicants for water supply for a Non-Agricultural Project shall be required to pay a Processing Fee and may be required to pay a Reservation Fee as shown in Table A. All Water Users shall also pay the applicable Connection Fee, if necessary, and regular water service fees according to the District water rate schedules, as modified from time to time.

5.2 A Non-Agricultural Project may also be subject to an annual Water Supply Development Fee, depending upon the nature, complexity, and water demands of the proposed project. The District will determine whether a proposed Non-Agricultural Project is subject to the Water Supply Development Fee for water supplied pursuant to this IWSP as follows:

5.2.1. A proposed project that will require water for a Municipal Use shall be subject to an annual Water Supply Development Fee as set forth in Table B if the projected water demand for the project is in excess of the project's estimated population multiplied by the District-wide per capita usage. Municipal Use projects without an appreciable residential component will be analyzed under sub-section 5.2.3.

5.2.2. A proposed project that will require water for an Industrial Use located in an unincorporated area of the County of Imperial shall be subject to an annual Water Supply Development Fee as set forth in Table B.

5.2.3. The applicability of the Water Supply Development Fee set forth in Table B to Mixed Use projects, Industrial Use projects located within a municipality, or Municipal Use projects without an appreciable residential component, will be determined by the District on a case-by-case basis, depending upon the proportion of types of land uses and the water demand proposed for the project.

5.3. A proposed Water User for a Non-Agricultural Projects may elect to provide some or all of the required water supply by paying for and implementing some other means of providing water in a manner approved by the District, such as conservation projects, water storage projects and/or use of an alternative source of supply, such as recycled water or some source of water other than from the District water supply. Such election shall require consultation with the District regarding the details of such alternatives and a determination by the District, in its reasonable discretion, concerning how much credit,

---

<sup>24</sup> The most recent fee schedules can be found in a link at IID/Water/ Municipal, Industrial and Commercial Customers; or visit by URL at [Imperial Irrigation District : Water Rate Schedules](#)

if any, should be given for such alternative water supply as against the project's water demand for purposes of determining the annual Water Supply Development Fee for such project.

5.4 The District Board shall have the right to modify the fees shown on Tables A and B from time to time.

6. Water Supply Development Fees collected by the District under this IWSP shall be accounted for independently, including reasonable accrued interest, and such fees shall only be used to help fund IWRMP or related District water supply projects.

7. Any request for water service for a proposed Non-Agricultural Project that meets the criteria for a water supply assessment pursuant to Water Code Sections 10910-10915 or a water supply verification pursuant to Government Code Section 66473.7 shall include all information required by Water Code Sections 10910 –10915 or Government Code Section 66473.7 to enable the District to prepare the water supply assessment or verification. All submittals should include sufficient detail and analysis regarding the project's water demands, including types of land use and per capita water usage, necessary to make the determinations outlined in Section 5.2.

8. Any request for water service for a proposed Non-Agricultural Project that does not meet the criteria for a water supply assessment pursuant to Water Code Section 10910-10915 or water supply verification pursuant to Government Code Section 66473.7 shall include a complete project description with a detailed map or diagram depicting the footprint of the proposed project, the size of the footprint, projected water demand at full implementation of the project and a schedule for implementing water service. All submittals should include sufficient detail and analysis regarding the project's water demands, including types of land use and per capita water usage, necessary to make the determinations outlined in Section 5.2.

9. All other District rules and policies regarding a project applicant or Water User's responsibility for paying connection fees, costs of capital improvements and reimbursing the District for costs of staff and consultant's time, engineering studies and administrative overhead required to process and implement projects remain in effect.

10. Municipal Use customers shall be required to follow appropriate water use efficiency best management practices (BMPs), including, but not limited to those established by the California Urban Water Conservation Council BMP's (see <http://www.cuwcc.org/mou/exhibit-1-bmp-definitions-schedules-requirements.aspx>), or other water use efficiency standards, adopted by the District or local government agencies.

11. Industrial Use customers shall be required to follow appropriate water use efficiency BMP's, including but not limited to those established by the California Urban Water Conservation Council and California Energy Commission, as well as other water use efficiency standards, adopted by the District or local government agencies.

12. The District may prescribe additional or different BMPs for certain categories of Municipal and Industrial Water Users.



(This page intentionally left blank)

## **ATTACHMENT B: IID EQUITABLE DISTRIBUTION PLAN<sup>25</sup>**

Adopted December 11, 2007  
Revised November 18, 2008  
Revised April 07, 2009  
Revised April 23, 2013  
Revised May 14, 2013  
Revised October 28, 2013  
Revised June 21, 2022

---

---

<sup>25</sup> Equitable Distribution Plan documents. June 21, 2022 <https://www.iid.com/water/rules-and-regulations/equitable-distribution>

# **ENERGY ASSESSMENT**

## **Green Valley Logistics Center Project County of Imperial**

*Prepared By:*

*Edin Consulting, Inc.*  
42428 Chisolm Trail  
Murrieta, California 92562  
(760) 473-1253

*Prepared For:*

**Chambers Group, Inc.  
5 Hutton Centre Drive  
Santa Ana, CA 92707**

**July 18, 2023**

## ***Introduction***

This analysis evaluates both construction and operational energy efficiency as it relates to non-renewable fuel sources including Electrical, Natural Gas, Diesel and Gasoline. The significance criteria for assessing the impacts to public services are derived from the California Environmental Quality Act (CEQA) Environmental Checklist. According to the CEQA Checklist, a project would cause a potentially significant impact if...

*The project would:*

- 1. Result in a potentially significant environmental impact due to wasteful, inefficient, or unnecessary consumption of energy resources, during project construction or operation?*
- 2. Conflict with or obstruct a state or local plan for renewable energy or energy efficiency?*

## ***Project Location***

The Project is located on approximately 285 gross acres within Imperial County, California, approximately 1.25 miles north of the City of Imperial. The Project is west of the Union Pacific Railroad (UPRR), east of SR 86 (Imperial Avenue), north of Harris Road, and south of Newside Drain Number 1-A. The Project is entirely within the Mesquite Lake Specific Plan on land owned by Tomcat Development LLC. The Project is within Section 31 of Township 14 South, Range 14 East, San Bernardino Base Meridian on APNs 040-340-004, 040-340-006, 040-340-032 and 040-340-033.

The majority of the Project will be accessed via a new north/south-running, 88-foot-wide Industrial Collector, which will connect to Harris Road to the south. Three secondary/emergency access points along SR 86 will be provided. The cemetery and memorial area will be accessed via the existing historical SR 86 access.

The Project area is zoned Mesquite Lake Specific Plan, including ML GS (Mesquite Lake Government / Special Public), ML I-2 (Mesquite Lake Medium Industrial) and ML I-3 (Mesquite Lake Heavy Industrial), with a Renewable Energy Overlay Zone. The General Plan Land Use designation for the entire Project is Mesquite Lake Specific Plan.

## ***Project Description***

The Project would allow for the development and operation of three (3) rail loop tracks totaling approximately 33,000 track feet, a rail ladder track totaling approximately 25,000 track feet, and an approximately 2,000 track feet spur that tie into the adjacent Union Pacific Railroad Right of Way (ROW) ('rail system').

The rail system will facilitate inbound and outbound trains of commodities as well as the transloading of commodities to and from trucks. Also included in the Project are a grain elevator; shipping container depot, a fuel blending / transloading area; a fueling station, warehousing and a veteran’s memorial area adjacent to the existing cemetery. The Project would also provide an extension to the SoCal Gas line from Keystone Road approximately 1.3 miles along State Route 86 to the Project Site.

Finally, the Project seeks a specific plan amendment and zone change from Light and Medium Industrial to Heavy Industrial. The plan requires a re-configuration of the existing parcels and would include a road right-of-way grant to the County for Industrial uses. The proposed uses are listed in Table 1.

**Table 1: Proposed Uses**

Use	Logistical Function / Description	Approximate Area (acres)
Existing Cemetery and Memorial Area	Regular Vehicle Traffic	10
Grain Elevator System	Inbound Rail – Outbound Truck for Corn/Grain Distribution to Cattle Feeder Yards	10
Centralized Water Treatment & Storage System	Provide Potable & Fire Water to the Project Area	2
Hay and Grain Export and Container Depot	Hay/Grain: Inbound Truck – Outbound Rail Containers: Inbound Rail – Outbound Rail and Truck	144
Produce / Food Export Transloading/Warehouse	Inbound Truck – Outbound Rail	10
Fuel Blending / Transloading	Inbound Rail – Outbound Truck	10
Fueling Station, including but not Limited to CNG	Trucks Already On-Site Fuel Up and Public Use	9.5
General Commodities: Transloading/Warehouse	Inbound Rail – Outbound Truck	64
Storm Water Retention Basin	Project Hydrology Program	19
Circulation	On-site Project Roadway	6
<b>Total</b>		<b>284.5</b>

**Project Construction**

Construction of the Project is expected to begin sometime in 2024 and would continue for approximately 18 months if the site is built-out under a single construction effort. Site preparation is anticipated to take approximately 2 months, grading to take approximately 2 months, and vertical construction to occur over approximately 14 months. Project build-out is expected in 2026. It should be noted depending on market demands, the Project construction



may occur incrementally over time though analysis under a single effort is considered worst case.

Site preparation will include clearing and grubbing which would require export to local recycling area. The land development includes grading to create rough graded streets, native soil preparatory work for track facilities, and pads for new construction. The site preparation will include an estimated 150,000 cubic yards (CY) of cut and 150,000 CY of fill; soil will be balanced on site.

The Project would require material imports which would include 140,000 CY of granular select fill for use underneath concrete building pads, an import of approximately 315,000 tons of ballast or 410,000 CY of material to construct the Project tracks and 28,000 tons or 32,000 CY of road base for the Industrial Street roadway, which will be surface finished with asphalt concrete. In all, the Project would import 582,000 CY of material and export roughly 1,000 CY of grubbed material.

A concrete and rebar bridge/over-pass or a culvert/under-pass may ultimately be built in order to take trucks to and from the inside of the loop tracks. Prior to the full loop tracks being constructed, a private roadway will be constructed for access to the central part of the Project.

## **Project Operations**

Routine operations and maintenance of the facility will include preventative maintenance and repairs of any damaged or otherwise inoperable equipment on an as-needed basis. The operation and maintenance staff will monitor the facility operations over the Project life to ensure that the logistics center is operating to meet design standards. Approximately 56 full-time employees are expected each day of the week during Project operations to cover all uses identified in Table 1 above and described below. The Project operations would require two shifts per day.

### *Existing Cemetery and Memorial Area*

The existing Memory Gardens Cemetery is part of the subject property and has existing water and electrical service from the Imperial Irrigation District. The property lines around the existing 7-acre cemetery are being adjusted for inclusion of a memorial area in honor of veterans east of and adjacent to the cemetery and the new cemetery overall area will be approximately 10 acres in total.

The cemetery and memorial area will be fenced-off from the remaining portion of the Project area with either chain link and privacy slats, wood, or vinyl fencing. Access to the cemetery (and memorial area) will be via the cemetery's existing and historical access from SR 86.

Improvements at the memorial area would consist of landscaping and lighting consistent with Mesquite Lake Specific Plan and County Planning & Development Services requirements.

Raw water is currently provided from the IID Dahlia Lateral 8 and such service will be continued in the future. Volunteers currently maintain the cemetery and will continue to do so in the future, likely under the ownership and management of a newly formed non-profit entity. The existing cemetery has approximately 20 vehicles coming on-site per day and an Average Daily Traffic (ADT) of 40 and no increase in traffic is expected to occur.

#### Grain Elevator System

The grain elevator is primarily for receiving corn and similar grain products via rail and distributing them to cattle feeding yards. The grain elevator system will be up to 180 feet tall and be comprised of up to four (4) large tanks/bins initially, expanding to a total of eight (8) large tanks/bins, and several ancillary mechanical components and will be built on a parcel that is approximately 10 acres. The grain elevator would receive approximately 450,000 tons (40-unit trains) of corn annually and approximately 150,000 tons (20 trains) of Dried Distillers Grain (DDG) annually via the proposed tracks. This portion of the Project would employ approximately eight people split between approximately two shifts per day (5am to 1pm and 11am to 7pm).

UPRR unit trains are currently 110 rail cars in length; however, the rail industry is moving to expand unit rail length to approximately 126 cars. The DDG would come into the site via approximately 75-car trains and may come in via the loop tracks or via the ladder tracks south of and adjacent to, the loop tracks. Grain such as corn and DDG may also be brought to the site by Union Pacific in smaller blocks such as 30 to 50 rail cars. Approximately 60 grain elevator trucks with an ADT of 120 would be required per day to take feed to customers.

#### Centralized Water Treatment, Storage & Distribution System

The Project will include a water treatment, storage and distribution system that will satisfy potable water and fire water requirements. The system will receive water from the IID Dahlia Lateral 8 canal located along the southerly boundary of the Project. The treatment, storage and pump elements of the system will be located on the approximately 2-acre Lot 10 shown on Figure 4. The distribution element of the system will be a looped pressurized water line that will provide access to water for all Project parcels. The water treatment, storage and distribution system will likely be developed in phases with an initial phase having a storage

capacity of approximately 180,000 gallons and a built-out storage capacity of up to 1.5 million gallons. A 1.5 million gallon tank would be approximately 50 feet tall and approximately 100 feet in diameter. During initial operations and prior to the need for a public water system, the applicant may truck-in purified/potable water.

#### Hay and Grain Export and Container Depot

The area in the middle of the loop tracks will be used primarily as a shipping container depot and for exporting hay and grain products via UPRR. The hay and grain export and container depot would employ approximately 12 people split between approximately two shifts per day (5am to 1pm and 11am to 7pm). Hay and grain trucks each carrying approximately twenty-five (25) containerized tons would be required per day to bring inbound hay and grain to the facility where it would be railed to the Ports of Los Angeles and Long Beach. The hay and grain would be grown within the irrigated area of Imperial County and brought to the site intermittently during hours of operation.

Ocean shipping containers would arrive on-site via UPRR from the Ports of Los Angeles and Long Beach full of miscellaneous products from overseas that are destined for distribution throughout the United States and Mexico. The miscellaneous products from overseas would be sorted and placed into domestic shipping containers for out-bound shipment via UPRR to major metropolitan hubs throughout the United States. In addition, full containers of miscellaneous products from the Ports of Los Angeles and Long Beach would arrive on-site via UPRR and be transloaded to truck for delivery to Mexico.

#### Produce / Food Export

The produce export function would employ approximately six people split between approximately two shifts per day (5am to 1pm and 11am to 7pm). Produce would be trucked in on-site from locally grown sources, maybe temperature treated (cold storage prior to customer shipment), and would be exported via UPRR to domestic and international customers. Such produces would likely consist of the following: (a) Broccoli: 45,000 tons, (b) Cabbage: 26,000 tons, (c) Carrot: 128,000 tons, (d) Cauliflower: 77,000 tons, (e) Cantaloupe: 120,000 tons, (f) Citrus: 2,000 tons, (g) Onion: 110,000 tons, and (h) beef: 42,000 tons.

Produce and food grown outside of the County would be railed into the County via UPRR, sorted, stored and shipped to Mexico via truck. Such produce and food would likely consist of the following: (a) Apples, Onions and Potatoes: 35,000 tons, (b) Dry food goods : 20,000 tons, (c) Palletized food products packaged in cans : 25,000 tons, (d) Frozen pork : 145,000 tons, (e) Frozen poultry : 160,000 tons, and (f) Processed food grain corn in super sacks : 20,000 tons.

### Fuel Blending / Transloading

Fuel products will be railed in on-site and transloaded/blended for outbound movement via truck to off-site locations, including Mexico. The approximate amount of fuel that will be annually transloaded/blended at the Project are as follows: (a) Biodiesel fuel: 130,000,000 gallons, (b) Regular diesel: 50,000,000 gallons, and (c) Liquefied Petroleum Gas (LPG)/Natural Gas Liquids (NGL): 90,000,000 gallons. The facility would have the ability to store up to 2,000,000 gallons of fuel on-site via up to four (4) above ground tanks.

### Fueling Station Including CNG

The fueling station would be used to fuel vehicles and trucks on site. The approximate amount of fuel sold from the fueling station on an annual basis is as follows: (a) Unleaded fuel: 2,500,000 gallons, (b) Diesel: 4,750,000 gallons, (c) CNG: 5,500,000 gallons. Electric vehicles and hydrogen fuel cell vehicles will also be able to fill up at the fueling station. There would also be truck scales on-site at the fueling station and throughout the rest of the Project site as well as an approximately 30,000 square foot travel center area. The SoCal Gas pipeline that is being extended to the Project site approximately 1.3 miles along State Route 86 from Keystone Road would supply gas to the CNG fueling component of the fueling station.

### General Commodities: Transloading/Warehousing

The remaining portion of the Project area that is not occupied by the rail system and above-mentioned Project elements will be used for the transloading, storage and shipment of additional commodities. The approximate types and amounts of general commodities being transloaded/warehoused on an annual basis on site is as follows: (a) Lumber: 150,000 tons, (b) Fertilizers: 30,000 tons, (c) Plastics: 60,000 tons, (d) Rolled Steel: 85,000 tons, (e) 35% Hydrochloric Acid: 60,000 tons, (f) 50% Caustic Soda: 40,000 tons, (g) 95% Sulfuric Acid: 25,000 tons and (h) Paper: 50,000 tons. Approximately 95 commodity trucks would be required per day with an ADT of 190. Transloading/warehousing of general commodities would employ approximately 18 people split between approximately two shifts per day (5am to 1pm and 11am to 7pm).

### Facilities

Each of the uses above would require the construction of ancillary structures including but not limited to transloading/warehousing buildings, mechanical equipment and misc. industrial appurtenances, office areas, parking areas, landscaping and parking. The facility sizes are not known at this time but for the purposes of this analysis it assumes that buildings such as warehouses with air conditioning could be approximately 1,050,000 SF.

## Project Utilities

### Water

The Proposed Project will receive raw water from IID via the Dahlia Lateral 8 and treat said raw water to potable standards for distribution to all Project elements which will procure their own respective quantities of water. The Project will also have its own dedicated raw water line for access to bulk process water from IID.

Over the last 10 years the Project site has consumed approximately 630 acre-feet (AF) of water per year on average in order for 120 acres of the Project site to be farmed. The proposed annual water usage, including operational water and drinking water for the Project site once fully developed would require 180 AF of water or a reduction for 450 AF of water per year. The Project will include septic systems with leach fields for the different elements of the logistics center in accordance with State and County standards. During initial operations and prior to the need for a public water system, the applicant may truck-in purified/potable water.

### Electrical

Electrical service will be from IID existing on-site distribution level voltage facilities near the cemetery, the existing IID on-site distribution level voltage facilities near the UPRR, IID existing distribution level voltage facilities south of the site along Harris Road, and/or self-generated with solar panels. If solar panels are used, they would be installed on the roofs of buildings and would interconnect by way of a bi-directional meter that would also serve as the metering element for power purchased from IID. The solar panels would be used solely for Project operations. The solar panels could utilize a battery energy storage element that would require approval from the County Planning Department, prior to installation. IID also has transmission level voltage facilities east of the site along the UPRR ROW, which can be tapped as needed for substation development.

### Natural Gas

Natural gas will come from the SoCal Gas existing pipeline system on Keystone Road.

Under Existing conditions many commodities are currently transported via truck from the Ports of Los Angeles and Long Beach, through the Inland Empire and Palm Desert, to the Calexico East Port of Entry via SR 86 and SR 111, or otherwise to/from destinations/origins within Imperial County. Development of the Project site with loop tracks and ladder tracks that tie into the adjacent Union Pacific Railroad will accommodate in-bound and out-bound trains with commodities as well as transloading to and from trucks, thereby reducing the number of truck



trips from Los Angeles and Long Beach. For example, a truckload of lumber or other commodities from Long Beach currently travels approximately 80-miles one-way within Imperial County. Post Project, the same lumber could be brought in via rail, and would only require an approximate 25-mile one-way trip by heavy vehicle to reach the same destination, thereby reducing the vehicle miles traveled by truck (LL&G, 2023).

#### Project Trip Generation and Truck Route Requirements

Trip Generation for the Project would be 107 average daily trips (ADT) for employee passenger vehicles and as many 436 ADT for heavy duty trucks each day (218 physical trucks) (LL&G, 2023).

As a Project feature, the Project will require inbound and outbound heavy trucks to adhere to the following designated truck routes (LL&G, 2023). The designated truck routes are intended to restrict heavy vehicles from turning across multiple lanes of oncoming traffic at unsignalized intersections on SR 111. The truck route requirements will be included as a Condition of Approval and will be enforced through on-site signage, off-site signage as appropriate, and in contracts with outside trucking agencies.

- When leaving the site, heavy trucks heading to the south / east via SR 111 will be required to make a right-turn out of the site onto SR 86, a right-turn from SR 86 to Keystone Road, a right-turn from Keystone Road to Dogwood Road, a left-turn from Dogwood Road onto Worthington Road, and a right-turn at the signalized intersection of Worthington Road and SR 111.
- Inbound trucks coming from the south / east via SR 111 will be required to make a left-turn at the signalized intersection of Worthington Road and SR 111, a right-turn onto Dogwood Road from Worthington Road, a left-turn onto Harris Road from Dogwood Road, a right-turn onto SR 86 from Harris Road, and a right-turn into the site.

Under Existing conditions many commodities are currently transported via truck from the Ports of Los Angeles and Long Beach, through the Inland Empire and Palm Desert, to the Calexico East Port of Entry via SR 86 and SR 111, or otherwise to/from destinations/origins within Imperial County. Development of the Project site with loop tracks and ladder tracks that tie into the adjacent Union Pacific Railroad will accommodate in-bound and out-bound trains with commodities as well as transloading to and from trucks, thereby reducing the number of truck trips from Los Angeles and Long Beach.

For example, a truckload of lumber or other commodities from Long Beach currently travels approximately 80-miles one-way within Imperial County. Post Project, the same lumber could

be brought in via rail, and would only require an approximate 25-mile one-way trip by heavy vehicle to reach the same destination, thereby reducing the vehicle miles traveled by 55 miles one-way by truck. For this reason, the Project would cumulatively reduce VMT for each trip produced by the Project and would therefore have a cumulative reduction on all energy usage from trucks. The reduced energy usage from the reduced VMT of the current usage of trucks is not included in this Project and instead is just assumed to be Zero.

### ***Construction***

Energy usage for construction equipment is best estimated using total horsepower hours and an assumed thermal efficiency of 30%. The most common measure of the energy efficiency of a tractor is referred to here as "specific volumetric fuel consumption" (SVFC), which is given in units of gallons per horsepower-hour (gal/hp-h). SVFC for diesel engines typically ranges from 0.0476 to 0.1110 gal/hp-h. Inverting these numbers yields a range of between 12 – 21 hp-h/gal. Over the last 30 years, fuel efficiency at maximum power has increased from roughly 14.5 to 16.5 hp-h/gal (Virginia Tech, 2010)

Project construction dates were estimated based on an estimated construction kickoff starting in early 2024 and completing the project 18 months later. Based on the equipment, quantity, work time, Horsepower (HP), the project would require a total of 1,395,920 hp-h (See Table 2 on the following page). Based on this, the project would consume roughly 84,601 gallons of diesel for construction. It should be noted that fuel consumption would go up if diesel construction equipment is poorly maintained. Based on this, the project shall properly maintain all equipment per manufacture recommendations.

Construction energy usage from workers vendors and hauling are based on the estimated vehicle miles traveled (VMT) for the total construction duration which is 1,921,345 miles total. In California, the average fuel intensity for on-road vehicles is 0.0615 gal/mile (University of California, Irvine, 2005). Based on this, vehicular trips would consume roughly 118,163 gallons total during construction.

On-road vehicles are regulated by state and federal regulations and vehicular fleet efficiencies are getting better each year. Additionally, all construction equipment shall be maintained as needed per the manufacturers' recommendations. Based on this, the short-term energy demand during construction of the project and would not result in a wasteful or inefficient use of energy.

**Table 2: Proposed Construction Phase and Duration**

Equipment Identification	Days	Hours per day	HP	Load Factor	Quantity	Horsepower Hours
<b>Site Preparation</b>	45					
Rubber Tired Dozers		8	247	0.4	3	106,704.00
Tractors/Loaders/Backhoes		8	97	0.37	4	51,681.60
<b>Grading</b>	45					
Excavators		8	158	0.38	2	43,228.80
Graders		8	187	0.41	1	27,601.20
Scrapers		8	367	0.48	1	63,417.60
Rubber Tired Dozers		8	247	0.4	2	71,136.00
Tractors/Loaders/Backhoes		8	97	0.37	2	25,840.80
<b>Building Construction</b>	323					
Cranes		7	231	0.29	2	302,928.78
Rough Terrain Forklifts		8	100	0.4	2	206,720.00
Aerial Lifts		8	63	0.31	2	100,931.04
Tractors/Loaders/Backhoes		7	97	0.37	3	243,441.87
Welders		8	46	0.45	1	53,488.80
<b>Architectural Coating</b>	225					
Air Compressors		6	78	0.48	1	50,544.00
<b>Paving</b>	25					
Rollers		8	80	0.38	2	12,160.00
Pavers		8	130	0.42	2	21,840.00
Paving Equipment		6	132	0.36	2	14,256.00
Total Horsepower Hours						1,395,920
Total Diesel Fuel (Gal) @ 16.5 hp-h/gal						84,601
Construction Lists identified within CalEEMod Attachment A to this report which was used for the project Air Quality analysis.						

Energy – Transportation Demand

Trip Generation for the Project would be 107 average daily trips (ADT) for employee passenger vehicles and as many 436 ADT for heavy duty trucks each day (218 physical trucks) (LL&G, 2023). The intent of this project however is to shift truckloads typically traveling from Long Beach or Los Angeles to Imperial County via Rail instead of trucks. Based on the traffic Study, the typical vehicle miles traveled before the Project would be 80 miles one way and once the Project is implemented, the average trip length would be 55 miles shorter to 25 miles for a one-way trip.

Since the intent of the project would be to increase opportunities for goods to be shipped via rail instead of trucks, a significant reduction in fuel demand would be expected compared to a scenario without the Project. Based on data provided by the Union Pacific, on average, trains

are four times more fuel efficient than trucks (Union Pacific, 2022). Since a net reduction in energy from vehicle trips and train activities, a less than significant energy demand with respect to transportation modes would be expected.

### Energy – Utility Demand

The State of California has implemented a number of energy reducing policies largely geared to reducing Greenhouse gasses (GHGs). The most notable is Assembly Bill (AB) 32, Senate Bill (SB) 32, and Executive Order (EO) S-3-05. In addition, the state has implemented two scoping plan updates which are geared to reduce GHG emissions by reducing energy consumption, increasing energy efficiency and increasing the usage of renewable sources. The state has also taken a strong step in increasing building efficiencies under Title 24, par 6 of California’s Code of Regulations.

The Project would be required, at a minimum, to comply with the latest version of Title 24 standards at the time the Project seeks building permits. At the time this report was written, the 2022 standards were applicable and went into effect on January 1, 2023. It should be noted that the State updates these regulations every three years. Thus, throughout Project construction, buildings will need to comply with the most recently adopted standards. Most industrial uses outside of buildings would not fall under the purview of Title 24.

Finally, the state has implemented a number of regulations which force electrical utility providers to increase renewable portfolios or procurement. Specifically, the following policies and how they shaped the current energy supply and the future energy horizon are noted below:

SB 1078 (2002) established the Renewables Portfolio Standard (RPS) program, which requires an annual increase in renewable generation by the utilities equivalent to at least 1 percent of sales, with an aggregate goal of 20 percent by 2017.

SB X1 2 (2011) expanded the RPS by establishing that 20 percent of the total electricity sold to retail customers in California per year by December 31, 2013, and 33 percent by December 31, 2020, and in subsequent years be secured from qualifying renewable energy sources. Under the bill, a renewable electrical generation facility is one that uses biomass, solar thermal, photovoltaic, wind, geothermal, fuel cells using renewable fuels, small hydroelectric generation of 30 megawatts or less, digester gas, municipal solid waste conversion, landfill gas, ocean wave, ocean thermal, or tidal current, and that meets other specified requirements with respect to its location. In addition to the retail sellers previously covered by the RPS, SB X1 2 added local, publicly owned electric utilities to the RPS.

SB 350 (2015) further expanded the RPS by establishing that 50 percent of the total electricity sold to retail customers in California per year by December 31, 2030 be secured from qualifying renewable energy sources. In addition, SB 350 includes the goal to double the energy efficiency savings in electricity and natural gas final end uses (such as heating, cooling, lighting, or class of energy uses on which an energy-efficiency program is focused) of retail customers through energy conservation and efficiency.

SB 100 (2018) has further accelerated and expanded the RPS, requiring achievement of a 50 percent RPS by December 31, 2026, and a 60 percent RPS by December 31, 2030. SB 100 also established a new statewide policy goal that calls for eligible renewable energy resources and zero-carbon resources to supply 100 percent of electricity retail sales and 100 percent of electricity procured to serve all state agencies by December 31, 2045.

### **Project Electrical and Natural Gas Energy Usage**

The Project would likely require facilities at buildout. The exact facility sizes are not known at this time. However, the Air Quality and Greenhouse Gas studies assumed a cumulative building size of 1,050,000 SF. Construction of these facilities may or may not happen depending on needs of the Project. Based on the air quality modeling, the project would on average consume 3,631,469 thousand British Thermal Units (kBtu) of natural Gas and 2,892,422 kilowatt hours (kWh) of electricity each year. Under that analysis, reductions from T24 (2019) were accounted for which would improve the efficiency of the project in terms of energy consumption. The applicant would receive both Natural Gas and Electricity from the Imperial Irrigation District. Based on this, energy use associated with project operation would not result in wasteful, inefficient, or an unnecessary use of energy. As noted earlier in this analysis the CalEEMod estimation output is provided as **Attachment A** to this letter.

### **Conclusions**

Based on this analysis and as noted above, the project would be required to meet the latest Title 24 and CALGreen requirements which would ensure the project meets energy efficiency requirements for facilities constructed in the development. The long-term energy demand during operations of the project would not result in a wasteful or inefficient use of energy since the proposed Project would largely shift the transport of goods from Long Beach and Los Angeles to Imperial County from trucks to rail which is known to reduce the demand on fuel by as much as 4 times (Union Pacific, 2022). Given this, the project would not result in a wasteful or inefficient use of energy and a less than significant impact under CEQA is expected. Finally, the project would not conflict with or obstruct the State's or Local plans for renewable energy or energy efficiency.



**Attachment A:** CalEEMod Model Results (Proposed Project)

**References:**

LL&G. (2023). *TRANSPORTATION IMPACT ANALYSIS GREEN VALLEY LOGISTICS CENTER*.

Union Pacific. (2022). *www.up.com*. Retrieved from <https://www.up.com/customers/track-record/tr082019-rail-pros-cons.htm>

University of California, Irvine. (2005). *Fuel Efficiency and Motor Vehicle Travel*. Retrieved from <http://citeseerx.ist.psu.edu/viewdoc/download?doi=10.1.1.367.2859&rep=rep1&type=pdf>

Virginia Tech. (2010). *Predicting Tractor Diesel Fuel Consumption*. Retrieved from <https://www.semanticscholar.org/paper/Predicting-Tractor-Diesel-Fuel-Consumption-Grisso-Perumpral/2631d1ae4f63bcf1b067e69804f904968f318571>

**ATTACHMENT A**

CALLEEMOD 2020.4.0

Green Valley Logistics (Imperial County) - Mitigated - Imperial County, Annual

**EMFAC Off-Model Adjustment Factors for Gasoline Light Duty Vehicle to Account for the SAFE Vehicle Rule Applied**

**Green Valley Logistics (Imperial County) - Mitigated**  
Imperial County, Annual

**1.0 Project Characteristics**

**1.1 Land Usage**

Land Uses	Size	Metric	Lot Acreage	Floor Surface Area	Population
General Heavy Industry	50.00	1000sqft	207.00	50,000.00	0
Unrefrigerated Warehouse-Rail	1,000.00	1000sqft	64.00	1,000,000.00	0
Parking Lot	350.00	Space	4.00	140,000.00	0
Convenience Market with Gas Pumps	16.00	Pump	9.50	2,258.80	0

**1.2 Other Project Characteristics**

Urbanization	Urban	Wind Speed (m/s)	3.4	Precipitation Freq (Days)	12
Climate Zone	15			Operational Year	2025

Utility Company Imperial Irrigation District

CO2 Intensity (lb/MW/hr)	189.98	CH4 Intensity (lb/MW/hr)	0.033	N2O Intensity (lb/MW/hr)	0.004
--------------------------	--------	--------------------------	-------	--------------------------	-------

**1.3 User Entered Comments & Non-Default Data**

Project Characteristics -

Land Use - 284.5 acres site

Construction Phase - Construction Schedule

Off-road Equipment - CE

Trips and VMT - Project would use 24,250 trucks to deliver 24CY of stone material per truck during Grading and Building Construction. Per Mitigation Measure AQMM-1... all haul routes and worker trips to and from the site shall be 100% paved.

On-road Fugitive Dust - The Project assumes 90% paved. As a mitigation measure, the Project applicant shall prepare a Haul Route Plan which needs to be 100% paved and all worker trips shall utilize 100% paved roadways.

Grading - 1,000 CY of export grubbed material

Architectural Coating -







Green Valley Logistics (Imperial County) - Mitigated - Imperial County, Annual

**EMFAC Off-Model Adjustment Factors for Gasoline Light Duty Vehicle to Account for the SAFE Vehicle Rule Applied**

tblFleetMix	MCY	0.02	0.00
tblFleetMix	MDV	0.14	0.00
tblFleetMix	MH	3.3880e-003	0.00
tblFleetMix	MHD	8.3250e-003	0.00
tblFleetMix	OBUS	9.4100e-004	0.00
tblFleetMix	SBUS	7.5200e-004	0.00
tblFleetMix	UBUS	1.1800e-004	0.00
tblGrading	MaterialExported	0.00	1,000.00
tblLandUse	LotAcreage	1.15	207.00
tblLandUse	LotAcreage	22.96	64.00
tblLandUse	LotAcreage	3.15	4.00
tblLandUse	LotAcreage	0.05	9.50
tblOffRoadEquipment	OffRoadEquipmentUnitAmount	1.00	2.00
tblOnRoadDust	HaulingPercentPave	50.00	100.00
tblOnRoadDust	HaulingPercentPave	50.00	100.00
tblOnRoadDust	HaulingPercentPave	50.00	100.00
tblOnRoadDust	HaulingPercentPave	50.00	100.00
tblOnRoadDust	HaulingPercentPave	50.00	100.00
tblOnRoadDust	VendorPercentPave	50.00	100.00
tblOnRoadDust	VendorPercentPave	50.00	100.00
tblOnRoadDust	VendorPercentPave	50.00	100.00
tblOnRoadDust	VendorPercentPave	50.00	100.00
tblOnRoadDust	WorkerPercentPave	50.00	100.00
tblOnRoadDust	WorkerPercentPave	50.00	100.00
tblOnRoadDust	WorkerPercentPave	50.00	100.00
tblOnRoadDust	WorkerPercentPave	50.00	100.00
tblOnRoadDust	WorkerPercentPave	50.00	100.00
tblOnRoadDust	RoadPercentPave	50	90

**FEC ORIGINAL PKG**

Green Valley Logistics (Imperial County) - Mitigated - Imperial County, Annual

**EMFAC Off-Model Adjustment Factors for Gasoline Light Duty Vehicle to Account for the SAFE Vehicle Rule Applied**

tb\SolidWaste	SolidWasteGenerationRate	940.00	188.00
tb\TripsAndVMT	HaulingTripNumber	0.00	2,965.35
tb\TripsAndVMT	HaulingTripNumber	0.00	21,284.65
tb\VehicleTrips	DV_TP	21.00	0.00
tb\VehicleTrips	DV_TP	5.00	0.00
tb\VehicleTrips	DV_TP	5.00	0.00
tb\VehicleTrips	PB_TP	65.00	0.00
tb\VehicleTrips	PB_TP	3.00	0.00
tb\VehicleTrips	PB_TP	3.00	0.00
tb\VehicleTrips	PR_TP	14.00	0.00
tb\VehicleTrips	PR_TP	92.00	100.00
tb\VehicleTrips	PR_TP	92.00	0.00
tb\VehicleTrips	ST_TR	322.50	0.00
tb\VehicleTrips	ST_TR	6.42	0.43
tb\VehicleTrips	ST_TR	1.74	0.00
tb\VehicleTrips	SU_TR	322.50	0.00
tb\VehicleTrips	SU_TR	5.09	0.43
tb\VehicleTrips	SU_TR	1.74	0.00
tb\VehicleTrips	WD_TR	322.50	0.00
tb\VehicleTrips	WD_TR	3.93	0.43
tb\VehicleTrips	WD_TR	1.74	0.00
tb\Water	IndoorWaterUseRate	167,314.87	0.00
tb\Water	IndoorWaterUseRate	11,562,500.00	0.00
tb\Water	IndoorWaterUseRate	231,250,000.00	12,000,000.00
tb\Water	OutdoorWaterUseRate	102,547.82	0.00
tb\Water	OutdoorWaterUseRate	0.00	46,650,000.00

FFEC ORIGINAL PKG

**2.0 Emissions Summary**

Green Valley Logistics (Imperial County) - Mitigated - Imperial County, Annual

**EMFAC Off-Model Adjustment Factors for Gasoline Light Duty Vehicle to Account for the SAFE Vehicle Rule Applied**

**2.1 Overall Construction**

**Unmitigated Construction**

Year	tons/yr											MT/yr				
	ROG	NOx	CO	SO2	Fugitive PM10	Exhaust PM10	PM10 Total	Fugitive PM2.5	Exhaust PM2.5	PM2.5 Total	Bio- CO2	NBio- CO2	Total CO2	CH4	N2O	CO2e
2024	4.8486	4.6892	4.7374	0.0168	1.2534	0.1418	1.3952	0.4746	0.1318	0.6064	0.0000	1,556.7915	1,556.7915	0.1656	0.1280	1,599.0603
2025	3.2764	1.9522	2.2374	8.7900e-003	0.3813	0.0459	0.4272	0.1042	0.0430	0.1472	0.0000	819.6773	819.6773	0.0613	0.0747	843.4787
Maximum	4.8486	4.6892	4.7374	0.0168	1.2534	0.1418	1.3952	0.4746	0.1318	0.6064	0.0000	1,556.7915	1,556.7915	0.1656	0.1280	1,599.0603

**Mitigated Construction**

Year	tons/yr											MT/yr				
	ROG	NOx	CO	SO2	Fugitive PM10	Exhaust PM10	PM10 Total	Fugitive PM2.5	Exhaust PM2.5	PM2.5 Total	Bio- CO2	NBio- CO2	Total CO2	CH4	N2O	CO2e
2024	4.6939	4.6514	5.4075	0.0168	0.8962	0.0425	0.9387	0.3044	0.0417	0.3461	0.0000	1,556.7909	1,556.7909	0.1656	0.1280	1,599.0597
2025	3.2344	2.1422	2.4638	8.7900e-003	0.3813	0.0211	0.4024	0.1042	0.0206	0.1249	0.0000	819.6771	819.6771	0.0613	0.0747	843.4784
Maximum	4.6939	4.6514	5.4075	0.0168	0.8962	0.0425	0.9387	0.3044	0.0417	0.3461	0.0000	1,556.7909	1,556.7909	0.1656	0.1280	1,599.0597

EEC ORIGINAL PKG

Green Valley Logistics (Imperial County) - Mitigated - Imperial County, Annual

**EMFAC Off-Model Adjustment Factors for Gasoline Light Duty Vehicle to Account for the SAFE Vehicle Rule Applied**

	ROG	NOx	CO	SO2	Fugitive PM10	Exhaust PM10	PM10 Total	Fugitive PM2.5	Exhaust PM2.5	PM2.5 Total	Bio- CO2	NBio-CO2	Total CO2	CH4	N2O	CO2e
Percent Reduction	2.42	-2.29	-12.85	0.00	21.85	66.11	26.41	29.41	64.37	37.51	0.00	0.00	0.00	0.00	0.00	0.00
Quarter	Start Date	End Date	Maximum Mitigated ROG + NOX (tons/quarter)													
3	11-15-2023	2-14-2024	0.6996													
4	2-15-2024	5-14-2024	1.5511													
5	5-15-2024	8-14-2024	2.1860													
6	8-15-2024	11-14-2024	3.3266													
7	11-15-2024	2-14-2025	3.3116													
8	2-15-2025	5-14-2025	3.0446													
9	5-15-2025	8-14-2025	0.5380													
		Highest	3.3266													
			Maximum Unmitigated ROG + NOX (tons/quarter)													
			0.5210													
			1.4556													
			2.2212													
			3.3621													
			3.3671													
			3.1183													
			0.5753													
			3.3671													



Green Valley Logistics (Imperial County) - Mitigated - Imperial County, Annual

**EMFAC Off-Model Adjustment Factors for Gasoline Light Duty Vehicle to Account for the SAFE Vehicle Rule Applied**

**2.2 Overall Operational  
Unmitigated Operational**

Category	tons/yr										MT/yr					
	ROG	NOx	CO	SO2	Fugitive PM10	Exhaust PM10	PM10 Total	Fugitive PM2.5	Exhaust PM2.5	PM2.5 Total	Bio- CO2	NBio- CO2	Total CO2	CH4	N2O	CO2e
Area	4.8543	1.2000e-004	0.0130	0.0000		5.0000e-005	5.0000e-005		5.0000e-005	5.0000e-005	0.0000	0.0253	0.0253	7.0000e-005	0.0000	0.0270
Energy	0.0196	0.1780	0.1495	1.0700e-003		0.0135	0.0135		0.0135	0.0135	0.0000	443.0391	443.0391	0.0470	8.8000e-003	448.8369
Mobile	4.6100e-003	2.9700e-003	0.0481	1.4000e-004	1.9135	8.0000e-005	1.9135	0.1935	7.0000e-005	0.1936	0.0000	13.0005	13.0005	3.9000e-004	3.8000e-004	13.1219
Waste						0.0000	0.0000		0.0000	0.0000	50.7477	0.0000	50.7477	2.9991	0.0000	125.7254
Water						0.0000	0.0000		0.0000	0.0000	3.8071	58.1269	61.9339	0.4011	0.0105	75.0780
<b>Total</b>	<b>4.8785</b>	<b>0.1811</b>	<b>0.2106</b>	<b>1.2100e-003</b>	<b>1.9135</b>	<b>0.0137</b>	<b>1.9271</b>	<b>0.1935</b>	<b>0.0137</b>	<b>0.2071</b>	<b>54.5548</b>	<b>514.1918</b>	<b>568.7466</b>	<b>3.4477</b>	<b>0.0196</b>	<b>660.7892</b>



Green Valley Logistics (Imperial County) - Mitigated - Imperial County, Annual

**EMFAC Off-Model Adjustment Factors for Gasoline Light Duty Vehicle to Account for the SAFE Vehicle Rule Applied**

**2.2 Overall Operational  
Mitigated Operational**

Category	tons/yr											MT/yr				
	ROG	NOx	CO	SO2	Fugitive PM10	Exhaust PM10	PM10 Total	Fugitive PM2.5	Exhaust PM2.5	PM2.5 Total	Bio- CO2	NBio- CO2	Total CO2	CH4	N2O	CO2e
Area	4.8543	1.2000e-004	0.0130	0.0000	5.0000e-005	5.0000e-005	5.0000e-005	5.0000e-005	5.0000e-005	5.0000e-005	0.0000	0.0253	0.0253	7.0000e-005	0.0000	0.0270
Energy	0.0196	0.1780	0.1495	1.0700e-003	0.0135	0.0135	0.0135	0.0135	0.0135	0.0135	0.0000	443.0391	443.0391	0.0470	8.8000e-003	446.8369
Mobile	4.6100e-003	2.9700e-003	0.0481	1.4000e-004	1.9135	8.0000e-005	1.9135	0.1935	7.0000e-005	0.1936	0.0000	13.0005	13.0005	3.9000e-004	3.8000e-004	13.1219
Waste						0.0000	0.0000		0.0000	0.0000	50.7477	0.0000	50.7477	2.9991	0.0000	125.7254
Water						0.0000	0.0000		0.0000	0.0000	3.8071	58.1269	61.9339	0.4011	0.0105	75.0780
<b>Total</b>	<b>4.8785</b>	<b>0.1811</b>	<b>0.2106</b>	<b>1.2100e-003</b>	<b>1.9135</b>	<b>0.0137</b>	<b>1.9271</b>	<b>0.1935</b>	<b>0.0137</b>	<b>0.2071</b>	<b>54.5548</b>	<b>514.1918</b>	<b>568.7466</b>	<b>3.4477</b>	<b>0.0196</b>	<b>660.7892</b>

Percent Reduction	ROG	NOx	CO	SO2	Fugitive PM10	Exhaust PM10	PM10 Total	Fugitive PM2.5	Exhaust PM2.5	PM2.5 Total	Bio- CO2	NBio- CO2	Total CO2	CH4	N2O	CO2e
	0.00	0.00	0.00	0.00	0.00	0.00	0.00	0.00	0.00	0.00	0.00	0.00	0.00	0.00	0.00	0.00

**3.0 Construction Detail**

**Construction Phase**

Phase Number	Phase Name	Phase Type	Start Date	End Date	Num Days / Week	Num Days	Phase Description
1	Site Preparation	Site Preparation	1/1/2024	3/1/2024	5	45	
2	Grading	Grading	2/1/2024	4/3/2024	5	45	
3	Building Construction	Building Construction	4/4/2024	6/30/2025	5	323	

Green Valley Logistics (Imperial County) - Mitigated - Imperial County, Annual

**EMFAC Off-Model Adjustment Factors for Gasoline Light Duty Vehicle to Account for the SAFE Vehicle Rule Applied**

4	Paving	4/4/2024	5/8/2024	5	25
5	Architectural Coating	7/1/2024	5/9/2025	5	225

**Acres of Grading (Site Preparation Phase): 67.5**

**Acres of Grading (Grading Phase): 135**

**Acres of Paving: 4**

**Residential Indoor: 0; Residential Outdoor: 0; Non-Residential Indoor: 1,578,388; Non-Residential Outdoor: 526,129; Striped Parking Area: 8,400 (Architectural Coating – sqft)**

**OffRoad Equipment**

Phase Name	Offroad Equipment Type	Amount	Usage Hours	Horse Power	Load Factor
Site Preparation	Rubber Tired Dozers	3	8.00	247	0.40
Site Preparation	Tractors/Loaders/Backhoes	4	8.00	97	0.37
Grading	Excavators	2	8.00	158	0.38
Grading	Graders	1	8.00	187	0.41
Grading	Rubber Tired Dozers	1	8.00	247	0.40
Grading	Scrapers	2	8.00	367	0.48
Grading	Tractors/Loaders/Backhoes	2	8.00	97	0.37
Building Construction	Aerial Lifts	2	8.00	63	0.31
Building Construction	Cranes	2	7.00	231	0.29
Building Construction	Rough Terrain Forklifts	2	8.00	100	0.40
Building Construction	Tractors/Loaders/Backhoes	3	7.00	97	0.37
Building Construction	Welders	1	8.00	46	0.45
Paving	Pavers	2	8.00	130	0.42
Paving	Paving Equipment	2	8.00	132	0.36
Paving	Rollers	2	8.00	80	0.38
Architectural Coating	Air Compressors	1	6.00	78	0.48

**Trips and VMT**

Green Valley Logistics (Imperial County) - Mitigated - Imperial County, Annual

**EMFAC Off-Model Adjustment Factors for Gasoline Light Duty Vehicle to Account for the SAFE Vehicle Rule Applied**

Phase Name	Offroad Equipment Count	Worker Trip Number	Vendor Trip Number	Hauling Trip Number	Worker Trip Length	Vendor Trip Length	Hauling Trip Length	Worker Vehicle Class	Vendor Vehicle Class	Hauling Vehicle Class
Site Preparation	7	18.00	0.00	125.00	7.30	8.90	20.00	LD_Mix	HDT_Mix	HHDT
Grading	8	20.00	0.00	2,965.35	7.30	8.90	20.00	LD_Mix	HDT_Mix	HHDT
Building Construction	10	501.00	195.00	21,284.65	7.30	8.90	20.00	LD_Mix	HDT_Mix	HHDT
Paving	6	15.00	0.00	0.00	7.30	8.90	20.00	LD_Mix	HDT_Mix	HHDT
Architectural Coating	1	100.00	0.00	0.00	7.30	8.90	20.00	LD_Mix	HDT_Mix	HHDT

**3.1 Mitigation Measures Construction**

- Use Cleaner Engines for Construction Equipment
- Use DPF for Construction Equipment
- Water Exposed Area
- Water Unpaved Roads
- Reduce Vehicle Speed on Unpaved Roads

**3.2 Site Preparation - 2024**

**Unmitigated Construction On-Site**

Category	ROG	NOx	CO	SO2	Fugitive PM10	Exhaust PM10	PM10 Total	Fugitive PM2.5	Exhaust PM2.5	PM2.5 Total	Bio- CO2	NBio- CO2	Total CO2	CH4	N2O	CO2e
tons/yr																
Fugitive Dust					0.4424	0.0000	0.4424	0.2273	0.0000	0.2273	0.0000	0.0000	0.0000	0.0000	0.0000	0.0000
Off-Road	0.0599	0.6115	0.4126	8.6000e-004		0.0277	0.0277		0.0255	0.0255	0.0000	75.2784	75.2784	0.0244	0.0000	75.8871
<b>Total</b>	<b>0.0599</b>	<b>0.6115</b>	<b>0.4126</b>	<b>8.6000e-004</b>	<b>0.4424</b>	<b>0.0277</b>	<b>0.4700</b>	<b>0.2273</b>	<b>0.0255</b>	<b>0.2528</b>	<b>0.0000</b>	<b>75.2784</b>	<b>75.2784</b>	<b>0.0244</b>	<b>0.0000</b>	<b>75.8871</b>

ECC ORIGINAL PKG

Green Valley Logistics (Imperial County) - Mitigated - Imperial County, Annual

**EMFAC Off-Model Adjustment Factors for Gasoline Light Duty Vehicle to Account for the SAFE Vehicle Rule Applied**

**3.2 Site Preparation - 2024**

**Unmitigated Construction Off-Site**

Category	tons/yr										MT/yr					
	ROG	NOx	CO	SO2	Fugitive PM10	Exhaust PM10	PM10 Total	Fugitive PM2.5	Exhaust PM2.5	PM2.5 Total	Bio- CO2	NBio- CO2	Total CO2	CH4	N2O	CO2e
Hauling	1.4000e-004	6.4800e-003	1.8200e-003	3.0000e-005	1.0900e-003	8.0000e-005	1.1700e-003	3.0000e-004	7.0000e-005	3.7000e-004	0.0000	3.1914	3.1914	1.0000e-005	5.0000e-004	3.3411
Vendor	0.0000	0.0000	0.0000	0.0000	0.0000	0.0000	0.0000	0.0000	0.0000	0.0000	0.0000	0.0000	0.0000	0.0000	0.0000	0.0000
Worker	1.2900e-003	6.7000e-004	8.0900e-003	2.0000e-005	2.2300e-003	1.0000e-005	2.2500e-003	5.9000e-004	1.0000e-005	6.0000e-004	0.0000	1.7488	1.7488	7.0000e-005	6.0000e-005	1.7679
<b>Total</b>	<b>1.4300e-003</b>	<b>7.1500e-003</b>	<b>9.9100e-003</b>	<b>5.0000e-005</b>	<b>3.3200e-003</b>	<b>9.0000e-005</b>	<b>3.4200e-003</b>	<b>8.9000e-004</b>	<b>8.0000e-005</b>	<b>9.7000e-004</b>	<b>0.0000</b>	<b>4.9402</b>	<b>4.9402</b>	<b>8.0000e-005</b>	<b>5.6000e-004</b>	<b>5.1090</b>

**Mitigated Construction On-Site**

Category	tons/yr										MT/yr					
	ROG	NOx	CO	SO2	Fugitive PM10	Exhaust PM10	PM10 Total	Fugitive PM2.5	Exhaust PM2.5	PM2.5 Total	Bio- CO2	NBio- CO2	Total CO2	CH4	N2O	CO2e
Fugitive Dust					0.1991	0.0000	0.1991	0.1023	0.0000	0.1023	0.0000	0.0000	0.0000	0.0000	0.0000	0.0000
Off-Road	0.0210	0.4290	0.5166	8.6000e-004		3.1900e-003	3.1900e-003	3.1900e-003	3.1900e-003	3.1900e-003	0.0000	75.2783	75.2783	0.0244	0.0000	75.8870
<b>Total</b>	<b>0.0210</b>	<b>0.4290</b>	<b>0.5166</b>	<b>8.6000e-004</b>	<b>0.1991</b>	<b>3.1900e-003</b>	<b>0.2023</b>	<b>0.1023</b>	<b>3.1900e-003</b>	<b>0.1055</b>	<b>0.0000</b>	<b>75.2783</b>	<b>75.2783</b>	<b>0.0244</b>	<b>0.0000</b>	<b>75.8870</b>



Green Valley Logistics (Imperial County) - Mitigated - Imperial County, Annual

**EMFAC Off-Model Adjustment Factors for Gasoline Light Duty Vehicle to Account for the SAFE Vehicle Rule Applied**

**3.2 Site Preparation - 2024**

**Mitigated Construction Off-Site**

Category	tons/yr										MT/yr					
	ROG	NOx	CO	SO2	Fugitive PM10	Exhaust PM10	PM10 Total	Fugitive PM2.5	Exhaust PM2.5	PM2.5 Total	Bio- CO2	NBio- CO2	Total CO2	CH4	N2O	CO2e
Hauling	1.4000e-004	6.4800e-003	1.8200e-003	3.0000e-005	1.0900e-003	8.0000e-005	1.1700e-003	3.0000e-004	7.0000e-005	3.7000e-004	0.0000	3.1914	3.1914	1.0000e-005	5.0000e-004	3.3411
Vendor	0.0000	0.0000	0.0000	0.0000	0.0000	0.0000	0.0000	0.0000	0.0000	0.0000	0.0000	0.0000	0.0000	0.0000	0.0000	0.0000
Worker	1.2900e-003	6.7000e-004	8.0900e-003	2.0000e-005	2.2300e-003	1.0000e-005	2.2500e-003	5.9000e-004	1.0000e-005	6.0000e-004	0.0000	1.7488	1.7488	7.0000e-005	6.0000e-005	1.7679
<b>Total</b>	<b>1.4300e-003</b>	<b>7.1500e-003</b>	<b>9.9100e-003</b>	<b>5.0000e-005</b>	<b>3.3200e-003</b>	<b>9.0000e-005</b>	<b>3.4200e-003</b>	<b>8.9000e-004</b>	<b>8.0000e-005</b>	<b>9.7000e-004</b>	<b>0.0000</b>	<b>4.9402</b>	<b>4.9402</b>	<b>8.0000e-005</b>	<b>5.6000e-004</b>	<b>5.1090</b>

**3.3 Grading - 2024**

**Unmitigated Construction On-Site**

Category	tons/yr										MT/yr					
	ROG	NOx	CO	SO2	Fugitive PM10	Exhaust PM10	PM10 Total	Fugitive PM2.5	Exhaust PM2.5	PM2.5 Total	Bio- CO2	NBio- CO2	Total CO2	CH4	N2O	CO2e
Fugitive Dust					0.2071	0.0000	0.2071	0.0822	0.0000	0.0822	0.0000	0.0000	0.0000	0.0000	0.0000	0.0000
Off-Road	0.0724	0.7285	0.6238	1.4000e-003		0.0301	0.0301	0.0276	0.0276	0.0276	0.0000	122.6689	122.6689	0.0397	0.0000	123.6608
<b>Total</b>	<b>0.0724</b>	<b>0.7285</b>	<b>0.6238</b>	<b>1.4000e-003</b>	<b>0.2071</b>	<b>0.0301</b>	<b>0.2371</b>	<b>0.0822</b>	<b>0.0276</b>	<b>0.1099</b>	<b>0.0000</b>	<b>122.6689</b>	<b>122.6689</b>	<b>0.0397</b>	<b>0.0000</b>	<b>123.6608</b>

EEC ORIGINAL PKG



Green Valley Logistics (Imperial County) - Mitigated - Imperial County, Annual

**EMFAC Off-Model Adjustment Factors for Gasoline Light Duty Vehicle to Account for the SAFE Vehicle Rule Applied**

**3.3 Grading - 2024**

**Unmitigated Construction Off-Site**

Category	tons/yr										MT/yr					
	ROG	NOx	CO	SO2	Fugitive PM10	Exhaust PM10	PM10 Total	Fugitive PM2.5	Exhaust PM2.5	PM2.5 Total	Bio- CO2	NBio- CO2	Total CO2	CH4	N2O	CO2e
Hauling	3.400e-003	0.1537	0.0432	7.9000e-004	0.0259	1.8000e-003	0.0277	7.1000e-003	1.7300e-003	8.8200e-003	0.0000	75.7248	75.7248	2.1000e-004	0.0119	79.2774
Vendor	0.0000	0.0000	0.0000	0.0000	0.0000	0.0000	0.0000	0.0000	0.0000	0.0000	0.0000	0.0000	0.0000	0.0000	0.0000	0.0000
Worker	1.4000e-003	7.4000e-004	8.9900e-003	2.0000e-005	2.4800e-003	1.0000e-005	2.4900e-003	6.6000e-004	1.0000e-005	6.7000e-004	0.0000	1.9431	1.9431	7.0000e-005	7.0000e-005	1.9644
<b>Total</b>	<b>4.8800e-003</b>	<b>0.1544</b>	<b>0.0522</b>	<b>8.1000e-004</b>	<b>0.0283</b>	<b>1.8100e-003</b>	<b>0.0301</b>	<b>7.7600e-003</b>	<b>1.7400e-003</b>	<b>9.4900e-003</b>	<b>0.0000</b>	<b>77.6679</b>	<b>77.6679</b>	<b>2.8000e-004</b>	<b>0.0120</b>	<b>81.2418</b>

**Mitigated Construction On-Site**

Category	tons/yr										MT/yr					
	ROG	NOx	CO	SO2	Fugitive PM10	Exhaust PM10	PM10 Total	Fugitive PM2.5	Exhaust PM2.5	PM2.5 Total	Bio- CO2	NBio- CO2	Total CO2	CH4	N2O	CO2e
Fugitive Dust					0.0932	0.0000	0.0932	0.0370	0.0000	0.0370	0.0000	0.0000	0.0000	0.0000	0.0000	0.0000
Off-Road	0.0343	0.6745	0.8263	1.4000e-003		4.3900e-003	4.3900e-003		4.3900e-003	4.3900e-003	0.0000	122.6688	122.6688	0.0397	0.0000	123.6606
<b>Total</b>	<b>0.0343</b>	<b>0.6745</b>	<b>0.8263</b>	<b>1.4000e-003</b>	<b>0.0932</b>	<b>4.3900e-003</b>	<b>0.0976</b>	<b>0.0370</b>	<b>4.3900e-003</b>	<b>0.0414</b>	<b>0.0000</b>	<b>122.6688</b>	<b>122.6688</b>	<b>0.0397</b>	<b>0.0000</b>	<b>123.6606</b>

EEO ORIGINAL PKG

Green Valley Logistics (Imperial County) - Mitigated - Imperial County, Annual

**EMFAC Off-Model Adjustment Factors for Gasoline Light Duty Vehicle to Account for the SAFE Vehicle Rule Applied**

**3.3 Grading - 2024**

**Mitigated Construction Off-Site**

Category	tons/yr										MT/yr					
	ROG	NOx	CO	SO2	Fugitive PM10	Exhaust PM10	PM10 Total	Fugitive PM2.5	Exhaust PM2.5	PM2.5 Total	Bio- CO2	NBio- CO2	Total CO2	CH4	N2O	CO2e
Hauling	3.4400e-003	0.1537	0.0432	7.9000e-004	0.0259	1.8000e-003	0.0277	7.1000e-003	1.7300e-003	8.8200e-003	0.0000	75.7248	75.7248	2.1000e-004	0.0119	79.2774
Vendor	0.0000	0.0000	0.0000	0.0000	0.0000	0.0000	0.0000	0.0000	0.0000	0.0000	0.0000	0.0000	0.0000	0.0000	0.0000	0.0000
Worker	1.4400e-003	7.4000e-004	8.9900e-003	2.0000e-005	2.4800e-003	1.0000e-005	2.4900e-003	6.6000e-004	1.0000e-005	6.7000e-004	0.0000	1.9431	1.9431	7.0000e-005	7.0000e-005	1.9644
<b>Total</b>	<b>4.8800e-003</b>	<b>0.1544</b>	<b>0.0522</b>	<b>8.1000e-004</b>	<b>0.0263</b>	<b>1.8100e-003</b>	<b>0.0301</b>	<b>7.7600e-003</b>	<b>1.7400e-003</b>	<b>9.4900e-003</b>	<b>0.0000</b>	<b>77.6679</b>	<b>77.6679</b>	<b>2.8000e-004</b>	<b>0.0120</b>	<b>81.2418</b>

**3.4 Building Construction - 2024**

**Unmitigated Construction On-Site**

Category	tons/yr										MT/yr					
	ROG	NOx	CO	SO2	Fugitive PM10	Exhaust PM10	PM10 Total	Fugitive PM2.5	Exhaust PM2.5	PM2.5 Total	Bio- CO2	NBio- CO2	Total CO2	CH4	N2O	CO2e
Off-Road	0.1424	1.4616	1.6880	3.0200e-003		0.0560	0.0560		0.0519	0.0519	0.0000	261.3720	261.3720	0.0805	0.0000	263.3843
<b>Total</b>	<b>0.1424</b>	<b>1.4616</b>	<b>1.6880</b>	<b>3.0200e-003</b>		<b>0.0560</b>	<b>0.0560</b>		<b>0.0519</b>	<b>0.0519</b>	<b>0.0000</b>	<b>261.3720</b>	<b>261.3720</b>	<b>0.0805</b>	<b>0.0000</b>	<b>263.3843</b>

EEC ORIGINAL PKG

Green Valley Logistics (Imperial County) - Mitigated - Imperial County, Annual

**EMFAC Off-Model Adjustment Factors for Gasoline Light Duty Vehicle to Account for the SAFE Vehicle Rule Applied**

**3.4 Building Construction - 2024**  
Unmitigated Construction Off-Site

Category	tons/yr											MT/yr				
	ROG	NOx	CO	SO2	Fugitive PM10	Exhaust PM10	PM10 Total	Fugitive PM2.5	Exhaust PM2.5	PM2.5 Total	Bio- CO2	NBio- CO2	Total CO2	CH4	N2O	CO2e
Hauling	0.0148	0.6623	0.1863	3.4000e-003	0.1114	7.7800e-003	0.1192	0.0306	7.4400e-003	0.0380	0.0000	326.3922	326.3922	9.1000e-004	0.0513	341.7047
Vendor	0.0374	0.7732	0.3561	4.2700e-003	0.1554	6.9800e-003	0.1624	0.0446	6.6800e-003	0.0515	0.0000	407.4348	407.4348	1.7900e-003	0.0561	424.1925
Worker	0.1551	0.0800	0.9707	2.2400e-003	0.2681	1.3400e-003	0.2694	0.0712	1.2300e-003	0.0724	0.0000	209.8438	209.8438	7.8500e-003	7.0500e-003	212.1400
<b>Total</b>	<b>0.2073</b>	<b>1.5155</b>	<b>1.5132</b>	<b>9.9100e-003</b>	<b>0.5349</b>	<b>0.0161</b>	<b>0.5510</b>	<b>0.1465</b>	<b>0.0154</b>	<b>0.1619</b>	<b>0.0000</b>	<b>943.6708</b>	<b>943.6708</b>	<b>0.0106</b>	<b>0.1144</b>	<b>978.0372</b>

**Mitigated Construction On-Site**

Category	tons/yr											MT/yr				
	ROG	NOx	CO	SO2	Fugitive PM10	Exhaust PM10	PM10 Total	Fugitive PM2.5	Exhaust PM2.5	PM2.5 Total	Bio- CO2	NBio- CO2	Total CO2	CH4	N2O	CO2e
Off-Road	0.0781	1.6290	2.0166	3.0200e-003		0.0146	0.0146		0.0146	0.0146	0.0000	261.3717	261.3717	0.0805	0.0000	263.3840
<b>Total</b>	<b>0.0781</b>	<b>1.6290</b>	<b>2.0166</b>	<b>3.0200e-003</b>		<b>0.0146</b>	<b>0.0146</b>		<b>0.0146</b>	<b>0.0146</b>	<b>0.0000</b>	<b>261.3717</b>	<b>261.3717</b>	<b>0.0805</b>	<b>0.0000</b>	<b>263.3840</b>

EEC ORIGINAL PKG

Green Valley Logistics (Imperial County) - Mitigated - Imperial County, Annual

**EMFAC Off-Model Adjustment Factors for Gasoline Light Duty Vehicle to Account for the SAFE Vehicle Rule Applied**

**3.4 Building Construction - 2024**

**Mitigated Construction Off-Site**

Category	tons/yr										MT/yr					
	ROG	NOx	CO	SO2	Fugitive PM10	Exhaust PM10	PM10 Total	Fugitive PM2.5	Exhaust PM2.5	PM2.5 Total	Bio- CO2	NBio- CO2	Total CO2	CH4	N2O	CO2e
Hauling	0.0148	0.6623	0.1863	3.4000e-003	0.1114	7.7800e-003	0.1192	0.0306	7.4400e-003	0.0380	0.0000	326.3922	326.3922	9.1000e-004	0.0513	341.7047
Vendor	0.0374	0.7732	0.3561	4.2700e-003	0.1554	6.9800e-003	0.1624	0.0448	6.6800e-003	0.0515	0.0000	407.4348	407.4348	1.7900e-003	0.0561	424.1925
Worker	0.1551	0.0800	0.9707	2.2400e-003	0.2681	1.3400e-003	0.2694	0.0712	1.2300e-003	0.0724	0.0000	209.8438	209.8438	7.8500e-003	7.0500e-003	212.1400
<b>Total</b>	<b>0.2073</b>	<b>1.5155</b>	<b>1.5132</b>	<b>9.9100e-003</b>	<b>0.5349</b>	<b>0.0161</b>	<b>0.5510</b>	<b>0.1465</b>	<b>0.0154</b>	<b>0.1619</b>	<b>0.0000</b>	<b>943.6708</b>	<b>943.6708</b>	<b>0.0106</b>	<b>0.1144</b>	<b>978.0372</b>

**3.4 Building Construction - 2025**

**Unmitigated Construction On-Site**

Category	tons/yr										MT/yr					
	ROG	NOx	CO	SO2	Fugitive PM10	Exhaust PM10	PM10 Total	Fugitive PM2.5	Exhaust PM2.5	PM2.5 Total	Bio- CO2	NBio- CO2	Total CO2	CH4	N2O	CO2e
Off-Road	0.0888	0.9030	1.1156	2.0100e-003		0.0328	0.0328		0.0304	0.0304	0.0000	173.8431	173.8431	0.0535	0.0000	175.1794
<b>Total</b>	<b>0.0888</b>	<b>0.9030</b>	<b>1.1156</b>	<b>2.0100e-003</b>		<b>0.0328</b>	<b>0.0328</b>		<b>0.0304</b>	<b>0.0304</b>	<b>0.0000</b>	<b>173.8431</b>	<b>173.8431</b>	<b>0.0535</b>	<b>0.0000</b>	<b>175.1794</b>

EEC ORIGINAL PKG



Green Valley Logistics (Imperial County) - Mitigated - Imperial County, Annual

**EMFAC Off-Model Adjustment Factors for Gasoline Light Duty Vehicle to Account for the SAFE Vehicle Rule Applied**

**3.4 Building Construction - 2025  
Unmitigated Construction Off-Site**

Category	tons/yr										MT/yr					
	ROG	NOx	CO	SO2	Fugitive PM10	Exhaust PM10	PM10 Total	Fugitive PM2.5	Exhaust PM2.5	PM2.5 Total	Bio- CO2	NBio- CO2	Total CO2	CH4	N2O	CO2e
Hauling	9.8400e-003	0.4346	0.1241	2.2100e-003	0.0741	5.1400e-003	0.0792	0.0203	4.9200e-003	0.0253	0.0000	212.0364	212.0364	6.3000e-004	0.0333	221.9848
Vendor	0.0242	0.5069	0.2301	2.7900e-003	0.1033	4.6200e-003	0.1079	0.0298	4.4200e-003	0.0342	0.0000	266.2257	266.2257	1.1700e-003	0.0364	277.1063
Worker	0.0959	0.0476	0.5975	1.4400e-003	0.1783	8.4000e-004	0.1791	0.0473	7.7000e-004	0.0481	0.0000	136.1131	136.1131	4.7200e-003	4.3600e-003	137.5292
<b>Total</b>	<b>0.1300</b>	<b>0.9891</b>	<b>0.9517</b>	<b>6.4400e-003</b>	<b>0.3557</b>	<b>0.0106</b>	<b>0.3663</b>	<b>0.0974</b>	<b>0.0101</b>	<b>0.1075</b>	<b>0.0000</b>	<b>614.3752</b>	<b>614.3752</b>	<b>6.5200e-003</b>	<b>0.0741</b>	<b>636.6203</b>

**Mitigated Construction On-Site**

Category	tons/yr										MT/yr					
	ROG	NOx	CO	SO2	Fugitive PM10	Exhaust PM10	PM10 Total	Fugitive PM2.5	Exhaust PM2.5	PM2.5 Total	Bio- CO2	NBio- CO2	Total CO2	CH4	N2O	CO2e
Off-Road	0.0520	1.0832	1.3410	2.0100e-003		9.7400e-003	9.7400e-003		9.7400e-003	9.7400e-003	0.0000	173.8429	173.8429	0.0535	0.0000	175.1792
<b>Total</b>	<b>0.0520</b>	<b>1.0832</b>	<b>1.3410</b>	<b>2.0100e-003</b>		<b>9.7400e-003</b>	<b>9.7400e-003</b>		<b>9.7400e-003</b>	<b>9.7400e-003</b>	<b>0.0000</b>	<b>173.8429</b>	<b>173.8429</b>	<b>0.0535</b>	<b>0.0000</b>	<b>175.1792</b>

EEC ORIGINAL PKG



Green Valley Logistics (Imperial County) - Mitigated - Imperial County, Annual

**EMFAC Off-Model Adjustment Factors for Gasoline Light Duty Vehicle to Account for the SAFE Vehicle Rule Applied**

**3.4 Building Construction - 2025**

Mitigated Construction Off-Site

Category	tons/yr										MT/yr					
	ROG	NOx	CO	SO2	Fugitive PM10	Exhaust PM10	PM10 Total	Fugitive PM2.5	Exhaust PM2.5	PM2.5 Total	Bio- CO2	NBio- CO2	Total CO2	CH4	N2O	CO2e
Hauling	9.8400e-003	0.4346	0.1241	2.2100e-003	0.0741	5.1400e-003	0.0792	0.0203	4.9200e-003	0.0253	0.0000	212.0364	212.0364	6.3000e-004	0.0333	221.9848
Vendor	0.0242	0.5069	0.2301	2.7900e-003	0.1033	4.6200e-003	0.1079	0.0298	4.4200e-003	0.0342	0.0000	266.2257	266.2257	1.1700e-003	0.0364	277.1063
Worker	0.0959	0.0476	0.5975	1.4400e-003	0.1783	8.4000e-004	0.1791	0.0473	7.7000e-004	0.0481	0.0000	136.1131	136.1131	4.7200e-003	4.3600e-003	137.5292
<b>Total</b>	<b>0.1300</b>	<b>0.9891</b>	<b>0.9517</b>	<b>6.4400e-003</b>	<b>0.3557</b>	<b>0.0106</b>	<b>0.3663</b>	<b>0.0974</b>	<b>0.0101</b>	<b>0.1075</b>	<b>0.0000</b>	<b>614.3752</b>	<b>614.3752</b>	<b>6.5200e-003</b>	<b>0.0741</b>	<b>636.6203</b>

**3.5 Paving - 2024**

Unmitigated Construction On-Site

Category	tons/yr										MT/yr					
	ROG	NOx	CO	SO2	Fugitive PM10	Exhaust PM10	PM10 Total	Fugitive PM2.5	Exhaust PM2.5	PM2.5 Total	Bio- CO2	NBio- CO2	Total CO2	CH4	N2O	CO2e
Off-Road	0.0124	0.1191	0.1828	2.9000e-004		5.8600e-003	5.8600e-003		5.3900e-003	5.3900e-003	0.0000	25.0332	25.0332	8.1000e-003	0.0000	25.2356
Paving	5.2400e-003					0.0000	0.0000		0.0000	0.0000	0.0000	0.0000	0.0000	0.0000	0.0000	0.0000
<b>Total</b>	<b>0.0176</b>	<b>0.1191</b>	<b>0.1828</b>	<b>2.9000e-004</b>		<b>5.8600e-003</b>	<b>5.8600e-003</b>		<b>5.3900e-003</b>	<b>5.3900e-003</b>	<b>0.0000</b>	<b>25.0332</b>	<b>25.0332</b>	<b>8.1000e-003</b>	<b>0.0000</b>	<b>25.2356</b>

EFC ORIGINAL PKG

Green Valley Logistics (Imperial County) - Mitigated - Imperial County, Annual

**EMFAC Off-Model Adjustment Factors for Gasoline Light Duty Vehicle to Account for the SAFE Vehicle Rule Applied**

**3.5 Paving - 2024**

**Unmitigated Construction Off-Site**

Category	tons/yr										MT/yr					
	ROG	NOx	CO	SO2	Fugitive PM10	Exhaust PM10	PM10 Total	Fugitive PM2.5	Exhaust PM2.5	PM2.5 Total	Bio- CO2	NBio- CO2	Total CO2	CH4	N2O	CO2e
Hauling	0.0000	0.0000	0.0000	0.0000	0.0000	0.0000	0.0000	0.0000	0.0000	0.0000	0.0000	0.0000	0.0000	0.0000	0.0000	0.0000
Vendor	0.0000	0.0000	0.0000	0.0000	0.0000	0.0000	0.0000	0.0000	0.0000	0.0000	0.0000	0.0000	0.0000	0.0000	0.0000	0.0000
Worker	6.0000e-004	3.1000e-004	3.7500e-003	1.0000e-005	1.0300e-003	1.0000e-005	1.0400e-003	2.7000e-004	0.0000	2.8000e-004	0.0000	0.8096	0.8096	3.0000e-005	3.0000e-005	0.8185
<b>Total</b>	<b>6.0000e-004</b>	<b>3.1000e-004</b>	<b>3.7500e-003</b>	<b>1.0000e-005</b>	<b>1.0300e-003</b>	<b>1.0000e-005</b>	<b>1.0400e-003</b>	<b>2.7000e-004</b>	<b>0.0000</b>	<b>2.8000e-004</b>	<b>0.0000</b>	<b>0.8096</b>	<b>0.8096</b>	<b>3.0000e-005</b>	<b>3.0000e-005</b>	<b>0.8185</b>

**Mitigated Construction On-Site**

Category	tons/yr										MT/yr					
	ROG	NOx	CO	SO2	Fugitive PM10	Exhaust PM10	PM10 Total	Fugitive PM2.5	Exhaust PM2.5	PM2.5 Total	Bio- CO2	NBio- CO2	Total CO2	CH4	N2O	CO2e
Off-Road	7.0100e-003	0.1412	0.2162	2.9000e-004	1.1400e-003	1.1400e-003	1.1400e-003	1.1400e-003	1.1400e-003	1.1400e-003	0.0000	25.0331	25.0331	8.1000e-003	0.0000	25.2355
Paving	5.2400e-003				0.0000	0.0000	0.0000	0.0000	0.0000	0.0000	0.0000	0.0000	0.0000	0.0000	0.0000	0.0000
<b>Total</b>	<b>0.0123</b>	<b>0.1412</b>	<b>0.2162</b>	<b>2.9000e-004</b>	<b>1.1400e-003</b>	<b>1.1400e-003</b>	<b>1.1400e-003</b>	<b>1.1400e-003</b>	<b>1.1400e-003</b>	<b>1.1400e-003</b>	<b>0.0000</b>	<b>25.0331</b>	<b>25.0331</b>	<b>8.1000e-003</b>	<b>0.0000</b>	<b>25.2355</b>

EEC ORIGINAL PKG

Green Valley Logistics (Imperial County) - Mitigated - Imperial County, Annual

**EMFAC Off-Model Adjustment Factors for Gasoline Light Duty Vehicle to Account for the SAFE Vehicle Rule Applied**

**3.5 Paving - 2024**

**Mitigated Construction Off-Site**

Category	tons/yr										MT/yr					
	ROG	NOx	CO	SO2	Fugitive PM10	Exhaust PM10	PM10 Total	Fugitive PM2.5	Exhaust PM2.5	PM2.5 Total	Bio- CO2	NBio- CO2	Total CO2	CH4	N2O	CO2e
Hauling	0.0000	0.0000	0.0000	0.0000	0.0000	0.0000	0.0000	0.0000	0.0000	0.0000	0.0000	0.0000	0.0000	0.0000	0.0000	0.0000
Vendor	0.0000	0.0000	0.0000	0.0000	0.0000	0.0000	0.0000	0.0000	0.0000	0.0000	0.0000	0.0000	0.0000	0.0000	0.0000	0.0000
Worker	6.0000e-004	3.1000e-004	3.7500e-003	1.0000e-005	1.0300e-003	1.0000e-005	1.0400e-003	2.7000e-004	0.0000	2.8000e-004	0.0000	0.8096	0.8096	3.0000e-005	3.0000e-005	0.8185
<b>Total</b>	<b>6.0000e-004</b>	<b>3.1000e-004</b>	<b>3.7500e-003</b>	<b>1.0000e-005</b>	<b>1.0300e-003</b>	<b>1.0000e-005</b>	<b>1.0400e-003</b>	<b>2.7000e-004</b>	<b>0.0000</b>	<b>2.8000e-004</b>	<b>0.0000</b>	<b>0.8096</b>	<b>0.8096</b>	<b>3.0000e-005</b>	<b>3.0000e-005</b>	<b>0.8185</b>

**3.6 Architectural Coating - 2024**

**Unmitigated Construction On-Site**

Category	tons/yr										MT/yr					
	ROG	NOx	CO	SO2	Fugitive PM10	Exhaust PM10	PM10 Total	Fugitive PM2.5	Exhaust PM2.5	PM2.5 Total	Bio- CO2	NBio- CO2	Total CO2	CH4	N2O	CO2e
Archit. Coating	4.3091					0.0000	0.0000		0.0000	0.0000	0.0000	0.0000	0.0000	0.0000	0.0000	0.0000
Off-Road	0.0119	0.0804	0.1195	2.0000e-004	4.0200e-003	4.0200e-003	4.0200e-003	4.0200e-003	4.0200e-003	4.0200e-003	0.0000	16.8515	16.8515	9.5000e-004	0.0000	16.8752
<b>Total</b>	<b>4.3210</b>	<b>0.0804</b>	<b>0.1195</b>	<b>2.0000e-004</b>	<b>4.0200e-003</b>	<b>4.0200e-003</b>	<b>4.0200e-003</b>	<b>4.0200e-003</b>	<b>4.0200e-003</b>	<b>4.0200e-003</b>	<b>0.0000</b>	<b>16.8515</b>	<b>16.8515</b>	<b>9.5000e-004</b>	<b>0.0000</b>	<b>16.8752</b>

Green Valley Logistics (Imperial County) - Mitigated - Imperial County, Annual

**EMFAC Off-Model Adjustment Factors for Gasoline Light Duty Vehicle to Account for the SAFE Vehicle Rule Applied**

**3.6 Architectural Coating - 2024**

**Unmitigated Construction Off-Site**

Category	tons/yr											MT/yr				
	ROG	NOx	CO	SO2	Fugitive PM10	Exhaust PM10	PM10 Total	Fugitive PM2.5	Exhaust PM2.5	PM2.5 Total	Bio- CO2	NBio- CO2	Total CO2	CH4	N2O	CO2e
Hauling	0.0000	0.0000	0.0000	0.0000	0.0000	0.0000	0.0000	0.0000	0.0000	0.0000	0.0000	0.0000	0.0000	0.0000	0.0000	0.0000
Vendor	0.0000	0.0000	0.0000	0.0000	0.0000	0.0000	0.0000	0.0000	0.0000	0.0000	0.0000	0.0000	0.0000	0.0000	0.0000	0.0000
Worker	0.0211	0.0109	0.1318	3.0000e-004	0.0364	1.8000e-004	0.0366	9.6600e-003	1.7000e-004	9.8300e-003	0.0000	28.4991	28.4991	1.0700e-003	9.6000e-004	28.8109
<b>Total</b>	<b>0.0211</b>	<b>0.0109</b>	<b>0.1318</b>	<b>3.0000e-004</b>	<b>0.0364</b>	<b>1.8000e-004</b>	<b>0.0366</b>	<b>9.6600e-003</b>	<b>1.7000e-004</b>	<b>9.8300e-003</b>	<b>0.0000</b>	<b>28.4991</b>	<b>28.4991</b>	<b>1.0700e-003</b>	<b>9.6000e-004</b>	<b>28.8109</b>

**Mitigated Construction On-Site**

Category	tons/yr											MT/yr				
	ROG	NOx	CO	SO2	Fugitive PM10	Exhaust PM10	PM10 Total	Fugitive PM2.5	Exhaust PM2.5	PM2.5 Total	Bio- CO2	NBio- CO2	Total CO2	CH4	N2O	CO2e
Archit. Coating	4.3091					0.0000	0.0000		0.0000	0.0000	0.0000	0.0000	0.0000	0.0000	0.0000	0.0000
Off-Road	3.9200e-003	0.0896	0.1209	2.0000e-004		9.4000e-004	9.4000e-004		9.4000e-004	9.4000e-004	0.0000	16.8515	16.8515	9.5000e-004	0.0000	16.8752
<b>Total</b>	<b>4.3130</b>	<b>0.0896</b>	<b>0.1209</b>	<b>2.0000e-004</b>		<b>9.4000e-004</b>	<b>9.4000e-004</b>		<b>9.4000e-004</b>	<b>9.4000e-004</b>	<b>0.0000</b>	<b>16.8515</b>	<b>16.8515</b>	<b>9.5000e-004</b>	<b>0.0000</b>	<b>16.8752</b>

EEC ORIGINAL PKG



Green Valley Logistics (Imperial County) - Mitigated - Imperial County, Annual

**EMFAC Off-Model Adjustment Factors for Gasoline Light Duty Vehicle to Account for the SAFE Vehicle Rule Applied**

**3.6 Architectural Coating - 2024**

**Mitigated Construction Off-Site**

Category	tons/yr										MT/yr					
	ROG	NOx	CO	SO2	Fugitive PM10	Exhaust PM10	PM10 Total	Fugitive PM2.5	Exhaust PM2.5	PM2.5 Total	Bio- CO2	NBio- CO2	Total CO2	CH4	N2O	CO2e
Hauling	0.0000	0.0000	0.0000	0.0000	0.0000	0.0000	0.0000	0.0000	0.0000	0.0000	0.0000	0.0000	0.0000	0.0000	0.0000	0.0000
Vendor	0.0000	0.0000	0.0000	0.0000	0.0000	0.0000	0.0000	0.0000	0.0000	0.0000	0.0000	0.0000	0.0000	0.0000	0.0000	0.0000
Worker	0.0211	0.0109	0.1318	3.0000e-004	0.0364	1.8000e-004	0.0366	9.6600e-003	1.7000e-004	9.8300e-003	0.0000	28.4991	28.4991	1.0700e-003	9.6000e-004	28.8109
<b>Total</b>	<b>0.0211</b>	<b>0.0109</b>	<b>0.1318</b>	<b>3.0000e-004</b>	<b>0.0364</b>	<b>1.8000e-004</b>	<b>0.0366</b>	<b>9.6600e-003</b>	<b>1.7000e-004</b>	<b>9.8300e-003</b>	<b>0.0000</b>	<b>28.4991</b>	<b>28.4991</b>	<b>1.0700e-003</b>	<b>9.6000e-004</b>	<b>28.8109</b>

**3.6 Architectural Coating - 2025**

**Unmitigated Construction On-Site**

Category	tons/yr										MT/yr					
	ROG	NOx	CO	SO2	Fugitive PM10	Exhaust PM10	PM10 Total	Fugitive PM2.5	Exhaust PM2.5	PM2.5 Total	Bio- CO2	NBio- CO2	Total CO2	CH4	N2O	CO2e
Archit. Coating	3.0359					0.0000	0.0000		0.0000	0.0000	0.0000	0.0000	0.0000	0.0000	0.0000	0.0000
Off-Road	7.9400e-003	0.0533	0.0841	1.4000e-004		2.4000e-003	2.4000e-003		2.4000e-003	2.4000e-003	0.0000	11.8726	11.8726	6.5000e-004	0.0000	11.8888
<b>Total</b>	<b>3.0439</b>	<b>0.0533</b>	<b>0.0841</b>	<b>1.4000e-004</b>		<b>2.4000e-003</b>	<b>2.4000e-003</b>		<b>2.4000e-003</b>	<b>2.4000e-003</b>	<b>0.0000</b>	<b>11.8726</b>	<b>11.8726</b>	<b>6.5000e-004</b>	<b>0.0000</b>	<b>11.8888</b>

**EFC ORIGINAL PKG**



Green Valley Logistics (Imperial County) - Mitigated - Imperial County, Annual

**EMFAC Off-Model Adjustment Factors for Gasoline Light Duty Vehicle to Account for the SAFE Vehicle Rule Applied**

**3.6 Architectural Coating - 2025  
Unmitigated Construction Off-Site**

Category	tons/yr										MT/yr						
	ROG	NOx	CO	SO2	Fugitive PM10	Exhaust PM10	PM10 Total	Fugitive PM2.5	Exhaust PM2.5	PM2.5 Total	Bio- CO2	NBio- CO2	Total CO2	CH4	N2O	CO2e	
Hauling	0.0000	0.0000	0.0000	0.0000	0.0000	0.0000	0.0000	0.0000	0.0000	0.0000	0.0000	0.0000	0.0000	0.0000	0.0000	0.0000	0.0000
Vendor	0.0000	0.0000	0.0000	0.0000	0.0000	0.0000	0.0000	0.0000	0.0000	0.0000	0.0000	0.0000	0.0000	0.0000	0.0000	0.0000	0.0000
Worker	0.0138	6.8400e-003	0.0860	2.1000e-004	0.0257	1.2000e-004	0.0258	6.8100e-003	1.1000e-004	6.9200e-003	0.0000	19.5864	19.5864	6.8000e-004	6.3000e-004	19.7902	
<b>Total</b>	<b>0.0138</b>	<b>6.8400e-003</b>	<b>0.0860</b>	<b>2.1000e-004</b>	<b>0.0257</b>	<b>1.2000e-004</b>	<b>0.0258</b>	<b>6.8100e-003</b>	<b>1.1000e-004</b>	<b>6.9200e-003</b>	<b>0.0000</b>	<b>19.5864</b>	<b>19.5864</b>	<b>6.8000e-004</b>	<b>6.3000e-004</b>	<b>19.7902</b>	

**Mitigated Construction On-Site**

Category	tons/yr										MT/yr						
	ROG	NOx	CO	SO2	Fugitive PM10	Exhaust PM10	PM10 Total	Fugitive PM2.5	Exhaust PM2.5	PM2.5 Total	Bio- CO2	NBio- CO2	Total CO2	CH4	N2O	CO2e	
Archit. Coating	3.0359					0.0000	0.0000		0.0000	0.0000	0.0000	0.0000	0.0000	0.0000	0.0000	0.0000	
Off-Road	2.7600e-003	0.0631	0.0852	1.4000e-004		6.6000e-004	6.6000e-004		6.6000e-004	6.6000e-004	0.0000	11.8726	11.8726	6.5000e-004	0.0000	11.8888	
<b>Total</b>	<b>3.0387</b>	<b>0.0631</b>	<b>0.0852</b>	<b>1.4000e-004</b>		<b>6.6000e-004</b>	<b>6.6000e-004</b>		<b>6.6000e-004</b>	<b>6.6000e-004</b>	<b>0.0000</b>	<b>11.8726</b>	<b>11.8726</b>	<b>6.5000e-004</b>	<b>0.0000</b>	<b>11.8888</b>	

Green Valley Logistics (Imperial County) - Mitigated - Imperial County, Annual

**EMFAC Off-Model Adjustment Factors for Gasoline Light Duty Vehicle to Account for the SAFE Vehicle Rule Applied**

**3.6 Architectural Coating - 2025**

**Mitigated Construction Off-Site**

Category	tons/yr										MT/yr					
	ROG	NOx	CO	SO2	Fugitive PM10	Exhaust PM10	PM10 Total	Fugitive PM2.5	Exhaust PM2.5	PM2.5 Total	Bio- CO2	NBio- CO2	Total CO2	CH4	N2O	CO2e
Hauling	0.0000	0.0000	0.0000	0.0000	0.0000	0.0000	0.0000	0.0000	0.0000	0.0000	0.0000	0.0000	0.0000	0.0000	0.0000	0.0000
Vendor	0.0000	0.0000	0.0000	0.0000	0.0000	0.0000	0.0000	0.0000	0.0000	0.0000	0.0000	0.0000	0.0000	0.0000	0.0000	0.0000
Worker	0.0138	6.8400e-003	0.0860	2.1000e-004	0.0257	1.2000e-004	0.0258	6.8100e-003	1.1000e-004	6.9200e-003	0.0000	19.5864	19.5864	6.8000e-004	6.3000e-004	19.7902
<b>Total</b>	<b>0.0138</b>	<b>6.8400e-003</b>	<b>0.0860</b>	<b>2.1000e-004</b>	<b>0.0257</b>	<b>1.2000e-004</b>	<b>0.0258</b>	<b>6.8100e-003</b>	<b>1.1000e-004</b>	<b>6.9200e-003</b>	<b>0.0000</b>	<b>19.5864</b>	<b>19.5864</b>	<b>6.8000e-004</b>	<b>6.3000e-004</b>	<b>19.7902</b>

**4.0 Operational Detail - Mobile**

**4.1 Mitigation Measures Mobile**

Green Valley Logistics (Imperial County) - Mitigated - Imperial County, Annual

**EMFAC Off-Model Adjustment Factors for Gasoline Light Duty Vehicle to Account for the SAFE Vehicle Rule Applied**

Category	tons/yr											MT/yr				
	ROG	NOx	CO	SO2	Fugitive PM10	Exhaust PM10	PM10 Total	Fugitive PM2.5	Exhaust PM2.5	PM2.5 Total	Bi-CO2	NBi-CO2	Total CO2	CH4	N2O	CO2e
Mitigated	4.6100e-003	2.9700e-003	0.0481	1.4000e-004	1.9135	8.0000e-005	1.9135	0.1935	7.0000e-005	0.1936	0.0000	13.0005	13.0005	3.9000e-004	3.8000e-004	13.1219
Unmitigated	4.6100e-003	2.9700e-003	0.0481	1.4000e-004	1.9135	8.0000e-005	1.9135	0.1935	7.0000e-005	0.1936	0.0000	13.0005	13.0005	3.9000e-004	3.8000e-004	13.1219

**4.2 Trip Summary Information**

Land Use	Average Daily Trip Rate			Unmitigated Annual VMT	Mitigated Annual VMT
	Weekday	Saturday	Sunday		
Convenience Market with Gas Pumps	0.00	0.00	0.00		
General Heavy Industry	21.50	21.50	21.50	50,947	50,947
Parking Lot	0.00	0.00	0.00		
Unrefrigerated Warehouse-Rail	0.00	0.00	0.00		
<b>Total</b>	<b>21.50</b>	<b>21.50</b>	<b>21.50</b>	<b>50,947</b>	<b>50,947</b>

**4.3 Trip Type Information**

Land Use	Miles				Trip %				Trip Purpose %			
	H-W or C-W	H-S or C-C	H-O or C-NW	H-W or C-W	H-S or C-C	H-O or C-NW	H-W or C-W	H-S or C-C	H-O or C-NW	Primary	Diverted	Pass-by
Convenience Market with Gas	6.70	5.00	8.90	0.80	80.20	19.00	0	0	0	0	0	0
General Heavy Industry	6.70	5.00	8.90	59.00	28.00	13.00	100	0	0	0	0	0
Parking Lot	6.70	5.00	8.90	0.00	0.00	0.00	0	0	0	0	0	0
Unrefrigerated Warehouse-Rail	6.70	5.00	8.90	59.00	0.00	41.00	0	0	0	0	0	0

**4.4 Fleet Mix**

Green Valley Logistics (Imperial County) - Mitigated - Imperial County, Annual

**EMFAC Off-Model Adjustment Factors for Gasoline Light Duty Vehicle to Account for the SAFE Vehicle Rule Applied**

Land Use	LDA	LDT1	LDT2	MDV	LHD1	LHD2	MHD	HHD	OBUS	UBUS	MCY	SBUS	MH
Convenience Market with Gas Pumps	0.530702	0.059328	0.179664	0.144474	0.026250	0.006790	0.008325	0.016302	0.000941	0.000118	0.022966	0.000752	0.003388
General Heavy Industry	1.000000	0.000000	0.000000	0.000000	0.000000	0.000000	0.000000	0.000000	0.000000	0.000000	0.000000	0.000000	0.000000
Parking Lot	0.530702	0.059328	0.179664	0.144474	0.026250	0.006790	0.008325	0.016302	0.000941	0.000118	0.022966	0.000752	0.003388
Unrefrigerated Warehouse-Rail	0.530702	0.059328	0.179664	0.144474	0.026250	0.006790	0.008325	0.016302	0.000941	0.000118	0.022966	0.000752	0.003388

**5.0 Energy Detail**

Historical Energy Use: N

**5.1 Mitigation Measures Energy**

Category	tons/yr										MT/yr					CO2e
	ROG	NOx	CO	SO2	Fugitive PM10	Exhaust PM10	PM10 Total	Fugitive PM2.5	Exhaust PM2.5	PM2.5 Total	Bio- CO2	NBio- CO2	Total CO2	CH4	N2O	
Electricity Mitigated						0.0000	0.0000		0.0000	0.0000	0.0000	249.2501	249.2501	0.0433	5.2500e-003	251.8963
Electricity Unmitigated						0.0000	0.0000		0.0000	0.0000	0.0000	249.2501	249.2501	0.0433	5.2500e-003	251.8963
Natural Gas Mitigated	0.0196	0.1780	0.1495	1.0700e-003		0.0135	0.0135	0.0135	0.0135	0.0135	0.0000	193.7890	193.7890	3.7100e-003	3.5500e-003	194.9406
Natural Gas Unmitigated	0.0196	0.1780	0.1495	1.0700e-003		0.0135	0.0135	0.0135	0.0135	0.0135	0.0000	193.7890	193.7890	3.7100e-003	3.5500e-003	194.9406

Green Valley Logistics (Imperial County) - Mitigated - Imperial County, Annual

**EMFAC Off-Model Adjustment Factors for Gasoline Light Duty Vehicle to Account for the SAFE Vehicle Rule Applied**

**5.2 Energy by Land Use - NaturalGas**

**Unmitigated**

Land Use	NaturalGas Use kBTU/yr	ROG	NOx	CO	SO2	tons/yr				MT/yr				CO2e			
						Fugitive PM10	Exhaust PM10	PM10 Total	Fugitive PM2.5	Exhaust PM2.5	PM2.5 Total	Bio- CO2	NBio- CO2		Total CO2	CH4	N2O
Convenience Market with Gas Pumps	4969.36	3.0000e-005	2.4000e-004	2.0000e-004	0.0000	2.0000e-005	2.0000e-005	2.0000e-005	2.0000e-005	2.0000e-005	2.0000e-005	0.0000	0.2652	0.2652	1.0000e-005	0.0000	0.2668
General Heavy Industry	1.6165e+006	8.7200e-003	0.0792	0.0666	4.8000e-004	6.0200e-003	6.0200e-003	6.0200e-003	6.0200e-003	6.0200e-003	6.0200e-003	0.0000	86.2626	86.2626	1.6500e-003	1.5800e-003	86.7752
Parking Lot	0	0.0000	0.0000	0.0000	0.0000	0.0000	0.0000	0.0000	0.0000	0.0000	0.0000	0.0000	0.0000	0.0000	0.0000	0.0000	0.0000
Unrefrigerated Warehouse-Rail	2.01e+006	0.0108	0.0985	0.0828	5.9000e-004	7.4900e-003	7.4900e-003	7.4900e-003	7.4900e-003	7.4900e-003	7.4900e-003	0.0000	107.2613	107.2613	2.0600e-003	1.9700e-003	107.8987
<b>Total</b>		<b>0.0196</b>	<b>0.1780</b>	<b>0.1495</b>	<b>1.0700e-003</b>	<b>0.0135</b>	<b>0.0135</b>	<b>0.0135</b>	<b>0.0135</b>	<b>0.0135</b>	<b>0.0135</b>	<b>0.0000</b>	<b>193.7890</b>	<b>193.7890</b>	<b>3.7200e-003</b>	<b>3.5500e-003</b>	<b>194.9406</b>



Green Valley Logistics (Imperial County) - Mitigated - Imperial County, Annual

**EMFAC Off-Model Adjustment Factors for Gasoline Light Duty Vehicle to Account for the SAFE Vehicle Rule Applied**

**5.2 Energy by Land Use - NaturalGas**

**Mitigated**

Land Use	NaturalGas Use kBTU/yr	tons/yr										MT/yr							
		ROG	NOx	CO	SO2	Fugitive PM10	Exhaust PM10	PM10 Total	Fugitive PM2.5	Exhaust PM2.5	PM2.5 Total	Bio- CO2	NBio- CO2	Total CO2	CH4	N2O	CO2e		
Convenience Market with Gas Pumps	4969.36	3.0000e-005	2.4000e-004	2.0000e-004	0.0000		2.0000e-005		2.0000e-005		2.0000e-005		2.0000e-005		0.0000	0.2652	1.0000e-005	0.0000	0.2668
General Heavy Industry	1.6165e+006	8.7200e-003	0.0792	0.0666	4.8000e-004		6.0200e-003		6.0200e-003		6.0200e-003		6.0200e-003		0.0000	86.2626	1.6500e-003	1.5800e-003	86.7752
Parking Lot	0	0.0000	0.0000	0.0000	0.0000		0.0000		0.0000		0.0000		0.0000		0.0000	0.0000	0.0000	0.0000	0.0000
Unrefrigerated Warehouse-Rail	2.01e+006	0.0108	0.0985	0.0828	5.9000e-004		7.4900e-003		7.4900e-003		7.4900e-003		7.4900e-003		0.0000	107.2613	2.0600e-003	1.9700e-003	107.8987
<b>Total</b>		<b>0.0196</b>	<b>0.1780</b>	<b>0.1495</b>	<b>1.0700e-003</b>		<b>0.0135</b>		<b>0.0135</b>		<b>0.0135</b>		<b>0.0135</b>		<b>0.0000</b>	<b>193.7890</b>	<b>3.7200e-003</b>	<b>3.5500e-003</b>	<b>194.9406</b>

Green Valley Logistics (Imperial County) - Mitigated - Imperial County, Annual

**EMFAC Off-Model Adjustment Factors for Gasoline Light Duty Vehicle to Account for the SAFE Vehicle Rule Applied**

**5.3 Energy by Land Use - Electricity**

**Unmitigated**

Land Use	Electricity Use kWh/yr	Total CO2				CO2e
		CH4	N2O	MT/yr		
Convenience Market with Gas Pumps	27421.8	2.3630	4.1000e-004	5.0000e-005	2.3881	
General Heavy Industry	496000	42.7421	7.4200e-003	9.0000e-004	43.1958	
Parking Lot	49000	4.2225	7.3000e-004	9.0000e-005	4.2673	
Unrefrigerated Warehouse-Rail	2.32e+006	199.9225	0.0347	4.2100e-003	202.0450	
<b>Total</b>		<b>249.2501</b>	<b>0.0433</b>	<b>5.2500e-003</b>	<b>251.8963</b>	

**EMFAC Off-Model Adjustment Factors for Gasoline Light Duty Vehicle to Account for the SAFE Vehicle Rule Applied**

**5.3 Energy by Land Use - Electricity**

**Mitigated**

Land Use	Electricity Use	Total CO2	CH4	N2O	CO2e
	kWh/yr	MT/yr			
Convenience Market with Gas Pumps	27421.8	2.3630	4.1000e-004	5.0000e-005	2.3881
General Heavy Industry	496000	42.7421	7.4200e-003	9.0000e-004	43.1958
Parking Lot	49000	4.2225	7.3000e-004	9.0000e-005	4.2673
Unrefrigerated Warehouse-Rail	2.32e+006	199.9225	0.0347	4.2100e-003	202.0450
<b>Total</b>		<b>249.2501</b>	<b>0.0433</b>	<b>5.2500e-003</b>	<b>251.8963</b>

**6.0 Area Detail**

**6.1 Mitigation Measures Area**

Green Valley Logistics (Imperial County) - Mitigated - Imperial County, Annual

**EMFAC Off-Model Adjustment Factors for Gasoline Light Duty Vehicle to Account for the SAFE Vehicle Rule Applied**

Category	tms/yr										MT/yr					
	ROG	NOx	CO	SO2	Fugitive PM10	Exhaust PM10	PM10 Total	Fugitive PM2.5	Exhaust PM2.5	PM2.5 Total	Bio- CO2	NBio- CO2	Total CO2	CH4	N2O	CO2e
Mitigated	4.8543	1.2000e-004	0.0130	0.0000	5.0000e-005	5.0000e-005	5.0000e-005	5.0000e-005	5.0000e-005	5.0000e-005	0.0000	0.0253	0.0253	7.0000e-005	0.0000	0.0270
Unmitigated	4.8543	1.2000e-004	0.0130	0.0000	5.0000e-005	5.0000e-005	5.0000e-005	5.0000e-005	5.0000e-005	5.0000e-005	0.0000	0.0253	0.0253	7.0000e-005	0.0000	0.0270

**6.2 Area by SubCategory**

Unmitigated

SubCategory	tms/yr										MT/yr					
	ROG	NOx	CO	SO2	Fugitive PM10	Exhaust PM10	PM10 Total	Fugitive PM2.5	Exhaust PM2.5	PM2.5 Total	Bio- CO2	NBio- CO2	Total CO2	CH4	N2O	CO2e
Architectural Coating	0.7345				0.0000	0.0000	0.0000	0.0000	0.0000	0.0000	0.0000	0.0000	0.0000	0.0000	0.0000	0.0000
Consumer Products	4.1187				0.0000	0.0000	0.0000	0.0000	0.0000	0.0000	0.0000	0.0000	0.0000	0.0000	0.0000	0.0000
Landscaping	1.1900e-003	1.2000e-004	0.0130	0.0000	5.0000e-005	5.0000e-005	5.0000e-005	5.0000e-005	5.0000e-005	5.0000e-005	0.0000	0.0253	0.0253	7.0000e-005	0.0000	0.0270
<b>Total</b>	<b>4.8543</b>	<b>1.2000e-004</b>	<b>0.0130</b>	<b>0.0000</b>	<b>5.0000e-005</b>	<b>5.0000e-005</b>	<b>5.0000e-005</b>	<b>5.0000e-005</b>	<b>5.0000e-005</b>	<b>5.0000e-005</b>	<b>0.0000</b>	<b>0.0253</b>	<b>0.0253</b>	<b>7.0000e-005</b>	<b>0.0000</b>	<b>0.0270</b>

TEC ORIGINAL PKG

Green Valley Logistics (Imperial County) - Mitigated - Imperial County, Annual

**EMFAC Off-Model Adjustment Factors for Gasoline Light Duty Vehicle to Account for the SAFE Vehicle Rule Applied**

**6.2 Area by SubCategory**

Mitigated

SubCategory	ROG	NOx	CO	SO2	tons/yr					MT/yr						
					Fugitive PM10	Exhaust PM10	PM10 Total	Fugitive PM2.5	Exhaust PM2.5	PM2.5 Total	Bio- CO2	NBio- CO2	Total CO2	CH4	N2O	CO2e
Architectural Coating	0.7345				0.0000	0.0000	0.0000	0.0000	0.0000	0.0000	0.0000	0.0000	0.0000	0.0000	0.0000	0.0000
Consumer Products	4.1187				0.0000	0.0000	0.0000	0.0000	0.0000	0.0000	0.0000	0.0000	0.0000	0.0000	0.0000	0.0000
Landscaping	1.1900e-003	1.2000e-004	0.0130	0.0000	5.0000e-005	5.0000e-005	5.0000e-005	5.0000e-005	5.0000e-005	5.0000e-005	5.0000e-005	0.0253	7.0000e-005	0.0253	0.0000	0.0270
<b>Total</b>	<b>4.8543</b>	<b>1.2000e-004</b>	<b>0.0130</b>	<b>0.0000</b>	<b>5.0000e-005</b>	<b>5.0000e-005</b>	<b>5.0000e-005</b>	<b>5.0000e-005</b>	<b>5.0000e-005</b>	<b>5.0000e-005</b>	<b>5.0000e-005</b>	<b>0.0253</b>	<b>7.0000e-005</b>	<b>0.0253</b>	<b>0.0000</b>	<b>0.0270</b>

**7.0 Water Detail**

**7.1 Mitigation Measures Water**

**ECC ORIGINAL PKG**



Green Valley Logistics (Imperial County) - Mitigated - Imperial County, Annual

**EMFAC Off-Model Adjustment Factors for Gasoline Light Duty Vehicle to Account for the SAFE Vehicle Rule Applied**

Category	Total CO2	CH4	N2O	CO2e
Mitigated	61.9339	0.4011	0.0105	75.0780
Unmitigated	61.9339	0.4011	0.0105	75.0780

**7.2 Water by Land Use**

**Unmitigated**

Land Use	Indoor/Outdoor Use	Total CO2	CH4	N2O	CO2e
Convenience Market with Gas Pumps	0 / 0	0.0000	0.0000	0.0000	0.0000
General Heavy Industry	0 / 0	0.0000	0.0000	0.0000	0.0000
Parking Lot	0 / 0	0.0000	0.0000	0.0000	0.0000
Refrigerated Warehouse-Rail	12 / 46.65	61.9339	0.4011	0.0105	75.0780
<b>Total</b>		<b>61.9339</b>	<b>0.4011</b>	<b>0.0105</b>	<b>75.0780</b>

TEC ORIGINAL PKG

Green Valley Logistics (Imperial County) - Mitigated - Imperial County, Annual

**EMFAC Off-Model Adjustment Factors for Gasoline Light Duty Vehicle to Account for the SAFE Vehicle Rule Applied**

**7.2 Water by Land Use**

**Mitigated**

Land Use	Indoor/Outdoor Use	Total CO2	CH4	N2O	CO2e
	Mgal	MT/yr			
Convenience Market with Gas Pumps	0 / 0	0.0000	0.0000	0.0000	0.0000
General Heavy Industry	0 / 0	0.0000	0.0000	0.0000	0.0000
Parking Lot	0 / 0	0.0000	0.0000	0.0000	0.0000
Unrefrigerated Warehouse-Rail	12 / 46.65	61.9339	0.4011	0.0105	75.0780
<b>Total</b>		<b>61.9339</b>	<b>0.4011</b>	<b>0.0105</b>	<b>75.0780</b>

**8.0 Waste Detail**

**8.1 Mitigation Measures Waste**

REC ORIGINAL PKG

Green Valley Logistics (Imperial County) - Mitigated - Imperial County, Annual

**EMFAC Off-Model Adjustment Factors for Gasoline Light Duty Vehicle to Account for the SAFE Vehicle Rule Applied**

Category/Year

	Total CO2	CH4	N2O	CO2e
	MT/yr			
Mitigated	50.7477	2.9991	0.0000	125.7254
Unmitigated	50.7477	2.9991	0.0000	125.7254

**8.2 Waste by Land Use**

Unmitigated

Land Use	Waste Disposed tons	Total CO2	CH4	N2O	CO2e
General Heavy Industry	62	12.5854	0.7438	0.0000	31.1799
Parking Lot	0	0.0000	0.0000	0.0000	0.0000
Refrigerated Warehouse-Rail	188	38.1623	2.2553	0.0000	94.5455
<b>Total</b>		<b>50.7477</b>	<b>2.9991</b>	<b>0.0000</b>	<b>125.7254</b>

EEC ORIGINAL PKG

Green Valley Logistics (Imperial County) - Mitigated - Imperial County, Annual

**EMFAC Off-Model Adjustment Factors for Gasoline Light Duty Vehicle to Account for the SAFE Vehicle Rule Applied**

**8.2 Waste by Land Use**

**Mitigated**

Land Use	Waste Disposed tons	Total CO2	CH4	N2O	CO2e
		MT/yr			
General Heavy Industry	62	12.5854	0.7438	0.0000	31.1799
Parking Lot	0	0.0000	0.0000	0.0000	0.0000
Unrefrigerated Warehouse-Rail	188	38.1623	2.2553	0.0000	94.5455
<b>Total</b>		<b>50.7477</b>	<b>2.9991</b>	<b>0.0000</b>	<b>125.7254</b>

**9.0 Operational Offroad**

Equipment Type	Number	Hours/Day	Days/Year	Horse Power	Load Factor	Fuel Type
----------------	--------	-----------	-----------	-------------	-------------	-----------

**10.0 Stationary Equipment**

**Fire Pumps and Emergency Generators**

Equipment Type	Number	Hours/Day	Hours/Year	Horse Power	Load Factor	Fuel Type
----------------	--------	-----------	------------	-------------	-------------	-----------

**Boilers**

Equipment Type	Number	Heat Input/Day	Heat Input/Year	Boiler Rating	Fuel Type
----------------	--------	----------------	-----------------	---------------	-----------

**User Defined Equipment**

Equipment Type	Number
----------------	--------

REC ORIGINAL PKG

Green Valley Logistics (Imperial County) - Mitigated - Imperial County, Annual

**EMFAC Off-Model Adjustment Factors for Gasoline Light Duty Vehicle to Account for the SAFE Vehicle Rule Applied**

**11.0 Vegetation**

---



# *Ldn Consulting, Inc.*

42428 Chisolm Trail, Murrieta CA 92562  
www.ldnconsulting.net

phone 760-473-1253  
fax 760-689-4943

July 18, 2023

Chambers Group, Inc.  
5 Hutton Centre Dr Suite 750  
Santa Ana, CA 92707

**RE: Green Valley Logistics Center Project (GHG) Screening Letter – County of Imperial**

The purpose of this GHG screening letter is to identify potential GHG impacts, if any, which may be created from the construction and operation of the proposed Green Valley Logistics Center Project located in County of Imperial.

The Project is located on approximately 285 gross acres within Imperial County, California, approximately 1.25 miles north of the City of Imperial. The Project is west of the Union Pacific Railroad (UPRR), east of SR 86 (Imperial Avenue), north of Harris Road, and south of Newside Drain Number 1-A. The Project is entirely within the Mesquite Lake Specific Plan on land owned by Tomcat Development LLC. The Project is within Section 31 of Township 14 South, Range 14 East, San Bernardino Base Meridian on APNs 040-340-004, 040-340-006, 040-340-032 and 040-340-033.

The Project area is zoned Mesquite Lake Specific Plan, including ML GS (Mesquite Lake Government / Special Public), ML I-2 (Mesquite Lake Medium Industrial) and ML I-3 (Mesquite Lake Heavy Industrial), with a Renewable Energy Overlay Zone. The General Plan Land Use designation for the entire Project is Mesquite Lake Specific Plan.

The Project would allow for the development and operation of three (3) rail loop tracks totaling approximately 33,000 track feet, a rail ladder track totaling approximately 25,000 track feet, and an approximately 2,000 track feet spur that tie into the adjacent Union Pacific Railroad Right of Way (ROW) (‘rail system’).

The rail system will facilitate inbound and outbound trains of commodities as well as the transloading of commodities to and from trucks. Also included in the Project are a grain elevator; shipping container depot, a fuel blending / transloading area; a fueling station, warehousing and a veteran’s memorial area adjacent to the existing cemetery. The Project would also provide an extension to the SoCal Gas line from Keystone Road approximately 1.3 miles along State Route 86 to the Project Site. A general project site plan is shown in Figure 1 on the following page.

Figure 1: Project Area Overview Map

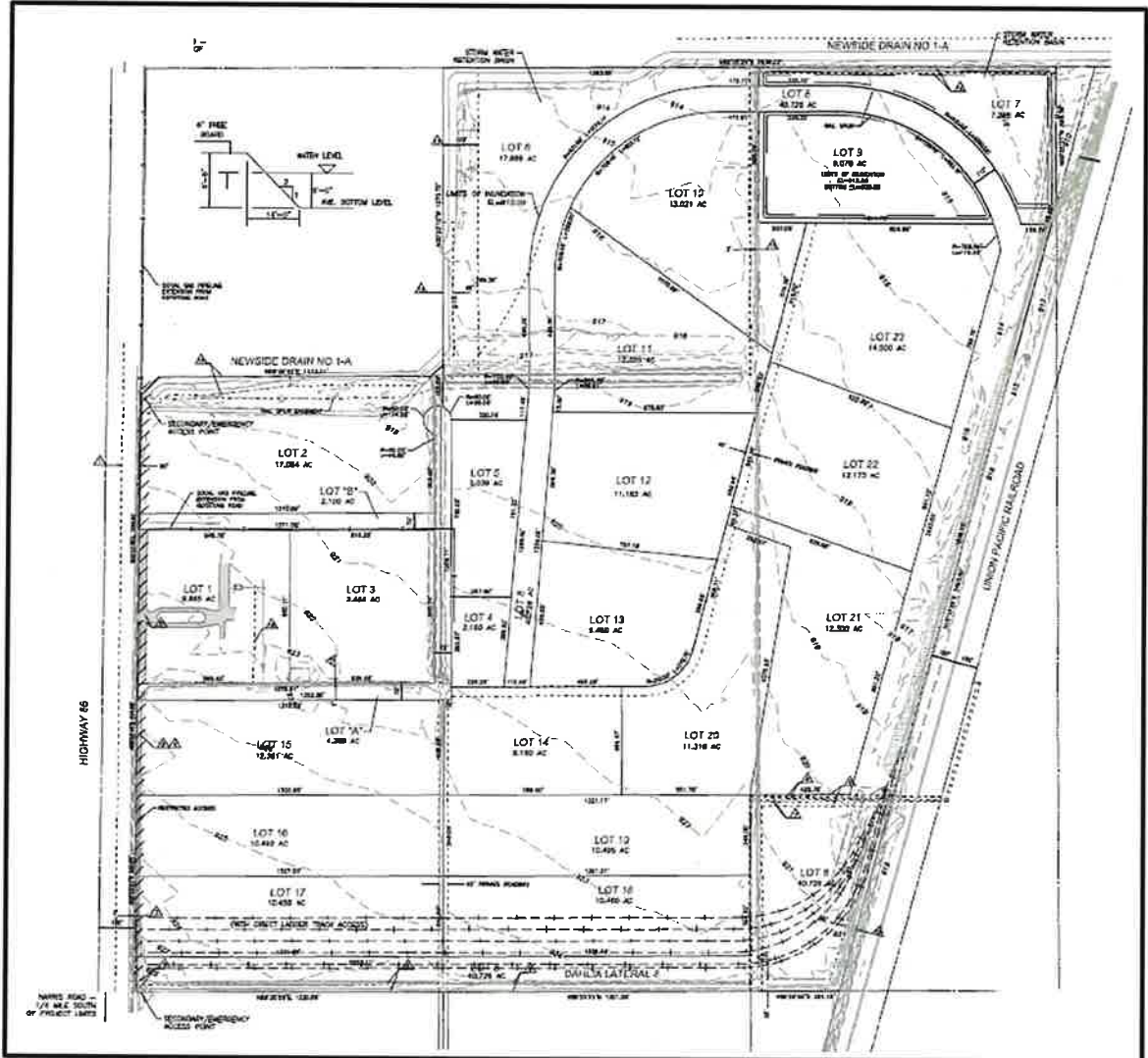

Source: (The Holt Group, 2023)

Finally, the Project seeks a specific plan amendment and zone change from Light and Medium Industrial to Heavy Industrial. The plan requires a re-configuration of the existing parcels and would include a road right-of-way grant to the County for Industrial uses.

Routine operations and maintenance of the facility will include preventative maintenance and repairs of any damaged or otherwise inoperable equipment on an as-needed basis. The operation and maintenance staff will monitor the facility operations over the Project life to ensure that the logistics center is operating to meet design standards. Approximately 56 full-time employees are expected each day of the week during Project operations to cover all uses identified in Table 1.

**Table 1: Proposed Uses**

Use	Logistical Function / Description	Approximate Area (acres)
Existing Cemetery and Memorial Area	Regular Vehicle Traffic	10
Grain Elevator System	Inbound Rail – Outbound Truck for Corn/Grain Distribution to Cattle Feeder Yards	10
Centralized Water Treatment & Storage System	Provide Potable & Fire Water to the Project Area	2
Hay and Grain Export and Container Depot	Hay/Grain: Inbound Truck – Outbound Rail Containers: Inbound Rail – Outbound Rail and Truck	144
Produce / Food Export Transloading/Warehouse	Inbound Truck – Outbound Rail	10
Fuel Blending / Transloading	Inbound Rail – Outbound Truck	10
Fueling Station, including but not Limited to CNG	Trucks Already On-Site Fuel Up and Public Use	9.5
General Commodities: Transloading/Warehouse	Inbound Rail – Outbound Truck	64
Storm Water Retention Basin	Project Hydrology Program	19
Circulation	On-site Project Roadway	6
	<b>Total</b>	<b>284.5</b>

Finally, it should be noted that this analysis assumes a construction of 1,050,000 SF of warehouse space. This space was assumed to be constructed over a short duration and would not be expected. Instead, the Project would construct these facilities over years.

**Construction**

Construction of the Project is expected to begin sometime in 2024 and would continue for approximately 18 months if the site is built-out under a single construction effort. Site

Chambers Group, Inc.  
5 Hutton Centre Dr Suite 750  
Santa Ana, CA 92707

*Edm Consulting, Inc.*  
42428 Chisolm Trail, Murrieta CA 92562  
phone 760-473-1253  
Fax 760-689-4943

preparation is anticipated to take approximately 2 months, grading to take approximately 2 months, and vertical construction to occur over approximately 14 months. Project build-out is expected in 2026. It should be noted depending on market demands, the Project construction may occur incrementally over time though analysis under a single effort is considered worst case.

Site preparation will include clearing and grubbing which would require export to local recycling area. The land development includes grading to create rough graded streets, native soil preparatory work for track facilities, and pads for new construction. The site preparation will include an estimated 150,000 cubic yards (CY) of cut and 150,000 CY of fill; soil will be balanced on site.

The Project would require material imports which would include 140,000 CY of granular select fill for use underneath concrete building pads, an import of approximately 315,000 tons of ballast or 410,000 CY of material to construct the Project tracks and 28,000 tons or 32,000 CY of road base for the Industrial Street roadway, which will be surface finished with asphalt concrete. In all, the Project would import 582,000 CY of material and export roughly 1,000 CY of grubbed material.

A concrete and rebar bridge/over-pass or a culvert/under-pass will ultimately be built in order to take trucks to and from the inside of the loop tracks. Prior to the full loop tracks being constructed, a private roadway will be constructed for access to the central part of the Project.

Table 2 on the following page shows the expected durations and construction equipment necessary to fully construct all the project infrastructure, structures and rail lines. Additionally, the project would implement a number of design features which are identified on the following page. These design features were assumed within all modeling and therefore would be required and considered a condition to this Project's approval.

GHG impacts related to construction and daily operations were calculated using the latest CalEEMod 2020.4.0 air quality model, which was developed by BREEZE Software for South Coast Air Quality Management District (SCAQMD) in 2017. The project construction model is provided as **Attachment A** to this letter.

**Table 2: Expected Construction Equipment**

Equipment Identification	Proposed Start	Proposed Complete	Quantity
<b>Site Preparation</b>	1/1/2024	3/1/2024	
Rubber Tired Dozers			3
Tractors/Loaders/Backhoes			4
<b>Grading</b>	2/1/2024	4/3/2024	
Excavators			2
Graders			1
Rubber Tired Dozers			1
Scrapers			2
Tractors/Loaders/Backhoes			2
<b>Building Construction</b>	4/4/2024	6/30/2025	
Aerial Lifts			2
Cranes			2
Rough Terrain Forklifts			2
Tractors/Loaders/Backhoes			3
Welders			1
<b>Paving</b>	4/4/2024	5/8/2024	
Pavers			2
Paving Equipment			2
Rollers			2
<b>Architectural Coating</b>	7/1/2024	5/9/2025	

**Operations**

Routine operations and maintenance of the facility will include preventative maintenance and repairs of any damaged or otherwise inoperable equipment on an as-needed basis. The operation and maintenance staff will monitor the facility operations over the Project life to ensure that the logistics center is operating to meet design standards. Approximately 56 full-time employees are expected each day of the week during Project operations to cover the below shown elements of the Project, with approximately 2 shifts per day (5am to 1pm and 11am to 7pm). The below shown Project elements will be developed in accordance with Mesquite Lake Specific Plan and County development standards.

Based on the projected traffic volumes estimated by the Project Traffic Engineer, the proposed project would generate approximately 107 regular employee ADT and as many as 436 ADT from heavy trucks (LL&G, 2023). As noted by the Project traffic engineer, the Green Valley Logistics Project would reduce regional vehicle miles travelled since the Logistics Center essentially would allow for train containers to bulk transfer goods between the Los Angeles Area to Imperial County which are currently being carried via trucks mostly. The regional



truck mileage associated with the Project site would essentially drop regional trips by more than a factor of 2/3 or 25 miles vs 80 miles previously. Since each truck using the Green Valley Logistics center would reduce miles traveled within the County of Imperial, only the employee trips were modeled within CalEEMod and no credit for the regional truck reductions was taken or calculated.

The Project area is currently being used for agricultural purposes and the site currently uses 630 acre-feet of water each year. The Project would reduce water consumption by 450 acre-feet per year and would use 180 acre-feet annually at buildout. The Project model assumes 180 acre-feet of water usage annually by the project and no credit for the 450 acre-feet was taken in this analysis.

The operations CalEEMod model for the site excluding the train activities is provided in **Attachment A** to this report.

The primary use of the site would enable goods to be shipped from the Los Angeles area into the County of Imperial in bulk via trains as opposed to via trucks which are currently being used. This effort would require as many as 2 trains daily. Each train was assumed to have two locomotives each and would have as many as 60 rail cars on each train.

Locomotive emissions within the Project site were not modeled within CalEEMod and instead were modeled separately using locomotive emissions inventories published by the EPA (EPA, 2012) analyzed separately from CalEEMod. Emissions inventories and calculations for locomotives onsite are provided in **Attachment B** to this report.

### **GHG Regulations**

The State of California Greenhouse Gas laws are based on the "the California Global Warming Solutions Act of 2006" (AB32), requires the California Air Resources Board (CARB) to adopt rules and regulations that would reduce GHG emissions to 1990 levels by 2020 and is outlined by the California Air Resource Board (ARB) (California Air Resource Board, 2014). As part of AB32 (Section 38562-A), the state board shall adopt greenhouse gas emission limits and emission reduction measures before January 1, 2011 and enforce these measures starting January 1, 2012. Currently, greenhouse gas emission limits for industrial projects such as the proposed project, have not been adopted by the State or Imperial County.

In the absence of GHG significance thresholds, it is reasonable to utilize South Coast Air Quality Management District thresholds. Within SCAQMD, the district has followed Tier 3 screening standards and Tier 4 Performance standards as the baseline for significance thresholds. Under this methodology, Tier 3 screening values are established at 3,000 MT/year CO<sub>2</sub>e for residential/commercial uses and 10,000 MT/year CO<sub>2</sub>e for industrial projects.

Greenhouse Gasses contributed from the proposed project are Carbon Dioxide (CO<sub>2</sub>), Methane (CH<sub>4</sub>), and Nitrous Oxide (N<sub>2</sub>O). For purposes of analysis, both CH<sub>4</sub> and N<sub>2</sub>O can be converted to an equivalent amount of CO<sub>2</sub> (CO<sub>2</sub>e) by multiplying the calculated levels of CH<sub>4</sub> and N<sub>2</sub>O by a Global Warming Potential (GWP). The U.S. Environmental Protection Agency publishes GWPs for various GHGs and reports that the GWP for CH<sub>4</sub> and N<sub>2</sub>O is 21 and 310, respectively.

**Project Related Construction Emissions**

Construction of the Project is expected to begin sometime in 2024 and would continue for approximately 18 months if the site is built-out under a single construction effort. Utilizing the CalEEMod inputs for the model as discussed above, grading and construction of the Project will produce approximately a maximum of 1,599.06 MT of CO<sub>2</sub>e within the first year of construction. Based on SQAQMD methodology, the Project would not exceed the 10,000 MT screening threshold for CO<sub>2</sub>e during any of the expected construction years. Based on this, a less than significant GHG impact would be expected from Construction. The emissions summary from CalEEMod is provided in Table 3 below.

**Table 3: Proposed Project Construction CO<sub>2</sub>e Emissions Summary MT/Year**

Year	Bio-CO2	NBio-CO2	Total CO2	CH4	N2O	CO2e
2024	0.00	1,556.79	1,556.79	0.17	0.13	1,599.06
2025	0.00	819.68	819.68	0.06	0.07	843.48

**Project Related Operational Emissions**

Based on the CalEEMod analysis, the proposed Project buildout would generate 465 MT CO<sub>2</sub>e annually without the use of locomotives, which is shown in Table 4 below. Locomotives were estimated to generate 6,822 MT CO<sub>2</sub>e annually (See **Attachment B** to this report). Combined the Project would generate 7,482.81 MT CO<sub>2</sub>e annually and is also shown in Table 4 below. Based on this, the project would not exceed the 10,000 MT annual screening threshold and would generate a less than significant operational GHG impact.

**Table 4: Operational GHG Emissions (MT/Year)**

Source	Bio-CO2	NBio-CO2	Total CO2	CH4	N2O	CO2e (MT/Yr)
Area	0.00	0.03	0.03	0.00	0.00	0.03
Energy	0.00	443.04	443.04	0.05	0.01	446.84
Mobile	0.00	13.00	13.00	0.00	0.00	13.12
Waste	50.75	0.00	50.75	3.00	0.00	125.73
Water	3.81	58.13	61.93	0.40	0.01	75.08
<b>Project GHG Emissions without locomotives</b>						<b>660.79</b>
<b>Locomotive Emissions</b>						<b>6,822.02</b>
<b>Total Emissions</b>						<b>7,482.81</b>
Data is presented in decimal format and may have rounding errors.						

Based on these findings, the project would have a less than significant GHG impact and would not require mitigation measures to comply with CEQA.

Sincerely,  
 Ldn Consulting, Inc.

Jeremy Loudon

**Attachment A:** CalEEMod Model Results (Proposed Project)  
**Attachment B:** Locomotive GHG Calculations

**References:**

California Air Resource Board. (2014, August 5). *Assembly Bill 32 Overview*. Retrieved 2016, from <http://www.arb.ca.gov/>: <http://www.arb.ca.gov/cc/ab32/ab32.htm>

EPA. (2012). *Locomotive Emission Inventories for the United States from ERTAC Rail*. Retrieved from <https://www3.epa.gov/ttnchie1/conference/ei20/session8/mbergin.pdf>

LL&G. (2023). *TRANSPORTATION IMPACT ANALYSIS GREEN VALLEY LOGISTICS CENTER*.

The Holt Group. (2023). *Project Site Layout*.

Green Valley Logistics (Imperial County) - Mitigated - Imperial County, Annual

**EMFAC Off-Model Adjustment Factors for Gasoline Light Duty Vehicle to Account for the SAFE Vehicle Rule Applied**

**Green Valley Logistics (Imperial County) - Mitigated**

Imperial County, Annual

**1.0 Project Characteristics**

**1.1 Land Usage**

Land Uses	Size	Metric	Lot Acreage	Floor Surface Area	Population
General Heavy Industry	50.00	1000sqft	207.00	50,000.00	0
Unrefrigerated Warehouse-Rail	1,000.00	1000sqft	64.00	1,000,000.00	0
Parking Lot	350.00	Space	4.00	140,000.00	0
Convenience Market with Gas Pumps	16.00	Pump	9.50	2,256.80	0

**1.2 Other Project Characteristics**

Urbanization	Urban	Wind Speed (m/s)	3.4	Precipitation Freq (Days)	12
Climate Zone	15			Operational Year	2025

Utility Company Imperial Irrigation District

CO2 Intensity (lb/MW/hr)	189.98	CH4 Intensity (lb/MW/hr)	0.033	N2O Intensity (lb/MW/hr)	0.004
--------------------------	--------	--------------------------	-------	--------------------------	-------

**1.3 User Entered Comments & Non-Default Data**

Project Characteristics -  
 Land Use - 284.5 acres site  
 Construction Phase - Construction Schedule  
 Off-road Equipment - CE  
 Trips and VMT - Project would use 24,250 trucks to deliver 24CY of stone material per truck during Grading and Building Construction. Per Mitigation Measure AQMM-1... all haul routes and worker trips to and from the site shall be 100% paved.  
 On-road Fugitive Dust - The Project assumes 90% paved. As a mitigation measure, the Project applicant shall prepare a Haul Route Plan which needs to be 100% paved and all worker trips shall utilize 100% paved roadways.  
 Grading - 1,000 CY of export grubbed material  
 Architectural Coating -









**EMFAC Off-Model Adjustment Factors for Gasoline Light Duty Vehicle to Account for the SAFE Vehicle Rule Applied**

tblFleetMix	MCY	0.02	0.00
tblFleetMix	MDV	0.14	0.00
tblFleetMix	MH	3.3880e-003	0.00
tblFleetMix	MHD	8.3250e-003	0.00
tblFleetMix	OBUS	9.4100e-004	0.00
tblFleetMix	SBUS	7.5200e-004	0.00
tblFleetMix	UBUS	1.1800e-004	1,000.00
tblGrading	MaterialExported	0.00	207.00
tblLandUse	LotAcreage	1.15	64.00
tblLandUse	LotAcreage	22.96	4.00
tblLandUse	LotAcreage	3.15	9.50
tblLandUse	LotAcreage	0.05	2.00
tblOffRoadEquipment	OffRoadEquipmentUnitAmount	1.00	100.00
tblOnRoadDust	HaulingPercentPave	50.00	100.00
tblOnRoadDust	HaulingPercentPave	50.00	100.00
tblOnRoadDust	HaulingPercentPave	50.00	100.00
tblOnRoadDust	HaulingPercentPave	50.00	100.00
tblOnRoadDust	HaulingPercentPave	50.00	100.00
tblOnRoadDust	VendorPercentPave	50.00	100.00
tblOnRoadDust	VendorPercentPave	50.00	100.00
tblOnRoadDust	VendorPercentPave	50.00	100.00
tblOnRoadDust	VendorPercentPave	50.00	100.00
tblOnRoadDust	WorkerPercentPave	50.00	100.00
tblOnRoadDust	WorkerPercentPave	50.00	100.00
tblOnRoadDust	WorkerPercentPave	50.00	100.00
tblOnRoadDust	WorkerPercentPave	50.00	100.00
tblOnRoadDust	WorkerPercentPave	50.00	100.00
tblOnRoadDust	WorkerPercentPave	50.00	100.00
tblOnRoadDust	RoadPercentPave	50	90

**EEC ORIGINAL PKG**



Green Valley Logistics (Imperial County) - Mitigated - Imperial County, Annual

**EMFAC Off-Model Adjustment Factors for Gasoline Light Duty Vehicle to Account for the SAFE Vehicle Rule Applied**

tbSolidWaste	SolidWasteGenerationRate	940.00	188.00
tbTripsAndVMT	HaulingTripNumber	0.00	2,965.35
tbTripsAndVMT	HaulingTripNumber	0.00	21,284.65
tbVehicleTrips	DV_TP	21.00	0.00
tbVehicleTrips	DV_TP	5.00	0.00
tbVehicleTrips	DV_TP	5.00	0.00
tbVehicleTrips	PB_TP	65.00	0.00
tbVehicleTrips	PB_TP	3.00	0.00
tbVehicleTrips	PB_TP	3.00	0.00
tbVehicleTrips	PR_TP	14.00	0.00
tbVehicleTrips	PR_TP	92.00	100.00
tbVehicleTrips	PR_TP	92.00	0.00
tbVehicleTrips	ST_TR	322.50	0.00
tbVehicleTrips	ST_TR	6.42	0.43
tbVehicleTrips	ST_TR	1.74	0.00
tbVehicleTrips	SU_TR	322.50	0.00
tbVehicleTrips	SU_TR	5.09	0.43
tbVehicleTrips	SU_TR	1.74	0.00
tbVehicleTrips	WD_TR	322.50	0.00
tbVehicleTrips	WD_TR	3.93	0.43
tbVehicleTrips	WD_TR	1.74	0.00
tbWater	IndoorWaterUseRate	167,314.87	0.00
tbWater	IndoorWaterUseRate	11,562,500.00	0.00
tbWater	IndoorWaterUseRate	231,250,000.00	12,000,000.00
tbWater	OutdoorWaterUseRate	102,547.82	0.00
tbWater	OutdoorWaterUseRate	0.00	46,650,000.00

FEC ORIGINAL PKG

**2.0 Emissions Summary**

Green Valley Logistics (Imperial County) - Mitigated - Imperial County, Annual

**EMFAC Off-Model Adjustment Factors for Gasoline Light Duty Vehicle to Account for the SAFE Vehicle Rule Applied**

**2.1 Overall Construction**

**Unmitigated Construction**

Year	tons/yr										MT/yr					
	ROG	NOx	CO	SO2	Fugitive PM10	Exhaust PM10	PM10 Total	Fugitive PM2.5	Exhaust PM2.5	PM2.5 Total	Bio- CO2	NBio- CO2	Total CO2	CH4	N2O	CO2e
2024	4.8486	4.6892	4.7374	0.0168	1.2534	0.1418	1.3952	0.4746	0.1318	0.6064	0.0000	1,556,791 <sub>5</sub>	1,556,791 <sub>5</sub>	0.1656	0.1280	1,599,060 <sub>3</sub>
2025	3.2764	1.9522	2.2374	8.7900e-003	0.3813	0.0459	0.4272	0.1042	0.0430	0.1472	0.0000	819,6773	819,6773	0.0613	0.0747	843,4787
Maximum	4.8486	4.6892	4.7374	0.0168	1.2534	0.1418	1.3952	0.4746	0.1318	0.6064	0.0000	1,556,791 <sub>5</sub>	1,556,791 <sub>5</sub>	0.1656	0.1280	1,599,060 <sub>3</sub>

**Mitigated Construction**

Year	tons/yr										MT/yr					
	ROG	NOx	CO	SO2	Fugitive PM10	Exhaust PM10	PM10 Total	Fugitive PM2.5	Exhaust PM2.5	PM2.5 Total	Bio- CO2	NBio- CO2	Total CO2	CH4	N2O	CO2e
2024	4.6939	4.6514	5.4075	0.0168	0.8962	0.0425	0.9387	0.3044	0.0417	0.3461	0.0000	1,556,790 <sub>9</sub>	1,556,790 <sub>9</sub>	0.1656	0.1280	1,599,059 <sub>7</sub>
2025	3.2344	2.1422	2.4638	8.7900e-003	0.3813	0.0211	0.4024	0.1042	0.0206	0.1249	0.0000	819,6771	819,6771	0.0613	0.0747	843,4784
Maximum	4.6939	4.6514	5.4075	0.0168	0.8962	0.0425	0.9387	0.3044	0.0417	0.3461	0.0000	1,556,790 <sub>9</sub>	1,556,790 <sub>9</sub>	0.1656	0.1280	1,599,059 <sub>7</sub>

EEC ORIGINAL PKG

Green Valley Logistics (Imperial County) - Mitigated - Imperial County, Annual

**EMFAC Off-Model Adjustment Factors for Gasoline Light Duty Vehicle to Account for the SAFE Vehicle Rule Applied**

	ROG	NOx	CO	SO2	Fugitive PM10	Exhaust PM10	PM10 Total	Fugitive PM2.5	Exhaust PM2.5	PM2.5 Total	Bio- CO2	NBio-CO2	Total CO2	CH4	N2O	CO2e
Percent Reduction	2.42	-2.29	-12.85	0.00	21.85	66.11	26.41	29.41	64.37	37.51	0.00	0.00	0.00	0.00	0.00	0.00
Quarter	Start Date	End Date	Maximum Mitigated ROG + NOX (tons/quarter)													
3	11-15-2023	2-14-2024	0.6996													
4	2-15-2024	5-14-2024	1.4556													
5	5-15-2024	8-14-2024	2.1860													
6	8-15-2024	11-14-2024	3.3266													
7	11-15-2024	2-14-2025	3.3116													
8	2-15-2025	5-14-2025	3.0446													
9	5-15-2025	8-14-2025	0.5380													
		Highest	3.3266													



Green Valley Logistics (Imperial County) - Mitigated - Imperial County, Annual

**EMFAC Off-Model Adjustment Factors for Gasoline Light Duty Vehicle to Account for the SAFE Vehicle Rule Applied**

**2.2 Overall Operational**  
**Unmitigated Operational**

Category	tons/yr										MT/yr					
	ROG	NOx	CO	SO2	Fugitive PM10	Exhaust PM10	PM10 Total	Fugitive PM2.5	Exhaust PM2.5	PM2.5 Total	Bio- CO2	NBio- CO2	Total CO2	CH4	N2O	CO2e
Area	4.8543	1.2000e-004	0.0130	0.0000		5.0000e-005	5.0000e-005		5.0000e-005	5.0000e-005	0.0000	0.0253	0.0253	7.0000e-005	0.0000	0.0270
Energy	0.0196	0.1780	0.1495	1.0700e-003		0.0135	0.0135		0.0135	0.0135	0.0000	443.0391	443.0391	0.0470	8.8000e-003	446.8369
Mobile	4.6100e-003	2.9700e-003	0.0481	1.4000e-004	1.9135	8.0000e-005	1.9135	0.1935	7.0000e-005	0.1936	0.0000	13.0005	13.0005	3.9000e-004	3.8000e-004	13.1219
Waste						0.0000	0.0000		0.0000	0.0000	50.7477	0.0000	50.7477	2.9991	0.0000	125.7254
Water						0.0000	0.0000		0.0000	0.0000	3.8071	58.1269	61.9339	0.4011	0.0105	75.0780
<b>Total</b>	<b>4.8785</b>	<b>0.1811</b>	<b>0.2106</b>	<b>1.2100e-003</b>	<b>1.9135</b>	<b>0.0137</b>	<b>1.9271</b>	<b>0.1935</b>	<b>0.0137</b>	<b>0.2071</b>	<b>54.5548</b>	<b>514.1918</b>	<b>568.7466</b>	<b>3.4477</b>	<b>0.0196</b>	<b>660.7892</b>

Green Valley Logistics (Imperial County) - Mitigated - Imperial County, Annual

**EMFAC Off-Model Adjustment Factors for Gasoline Light Duty Vehicle to Account for the SAFE Vehicle Rule Applied**

**2.2 Overall Operational**

**Mitigated Operational**

Category	tons/yr											MT/yr				
	ROG	NOx	CO	SO2	Fugitive PM10	Exhaust PM10	PM10 Total	Fugitive PM2.5	Exhaust PM2.5	PM2.5 Total	Bio- CO2	NBio- CO2	Total CO2	CH4	N2O	CO2e
Area	4.8543	1.2000e-004	0.0130	0.0000	5.0000e-005	5.0000e-005	5.0000e-005	5.0000e-005	5.0000e-005	5.0000e-005	0.0000	0.0253	0.0253	7.0000e-005	0.0000	0.0270
Energy	0.0196	0.1780	0.1495	1.0700e-003	0.0135	0.0135	0.0135	0.0135	0.0135	0.0135	0.0000	443.0391	443.0391	0.0470	8.8000e-003	446.8369
Mobile	4.6100e-003	2.9700e-003	0.0481	1.4000e-004	1.9135	8.0000e-005	1.9135	0.1935	7.0000e-005	0.1936	0.0000	13.0005	13.0005	3.9000e-004	3.8000e-004	13.1219
Waste						0.0000	0.0000	0.0000	0.0000	0.0000	50.7477	0.0000	50.7477	2.9991	0.0000	125.7254
Water						0.0000	0.0000	0.0000	0.0000	0.0000	3.8071	58.1269	61.9339	0.4011	0.0105	75.0780
<b>Total</b>	<b>4.8785</b>	<b>0.1811</b>	<b>0.2106</b>	<b>1.2100e-003</b>	<b>1.9135</b>	<b>0.0137</b>	<b>1.9271</b>	<b>0.1935</b>	<b>0.0137</b>	<b>0.2071</b>	<b>54.5548</b>	<b>514.1918</b>	<b>568.7466</b>	<b>3.4477</b>	<b>0.0196</b>	<b>660.7892</b>

Percent Reduction	ROG	NOx	CO	SO2	Fugitive PM10	Exhaust PM10	PM10 Total	Fugitive PM2.5	Exhaust PM2.5	PM2.5 Total	Bio- CO2	NBio- CO2	Total CO2	CH4	N2O	CO2e
	0.00	0.00	0.00	0.00	0.00	0.00	0.00	0.00	0.00	0.00	0.00	0.00	0.00	0.00	0.00	0.00

**3.0 Construction Detail**

**Construction Phase**

Phase Number	Phase Name	Phase Type	Start Date	End Date	Num Days Week	Num Days	Phase Description
1	Site Preparation	Site Preparation	1/1/2024	3/1/2024	5	45	
2	Grading	Grading	2/1/2024	4/3/2024	5	45	
3	Building Construction	Building Construction	4/4/2024	6/30/2025	5	323	

Green Valley Logistics (Imperial County) - Mitigated - Imperial County, Annual

**EMFAC Off-Model Adjustment Factors for Gasoline Light Duty Vehicle to Account for the SAFE Vehicle Rule Applied**

4	Paving	4/4/2024	5/8/2024	5	25
5	Architectural Coating	7/1/2024	5/9/2025	5	225

**Acres of Grading (Site Preparation Phase): 67.5**

**Acres of Grading (Grading Phase): 135**

**Acres of Paving: 4**

**Residential Indoor: 0; Residential Outdoor: 0; Non-Residential Indoor: 1,578,388; Non-Residential Outdoor: 526,129; Striped Parking Area: 8,400 (Architectural Coating – sqft)**

**OffRoad Equipment**

Phase Name	Offroad Equipment Type	Amount	Usage Hours	Horse Power	Load Factor
Site Preparation	Rubber Tired Dozers	3	8.00	247	0.40
Site Preparation	Tractors/Loaders/Backhoes	4	8.00	97	0.37
Grading	Excavators	2	8.00	158	0.38
Grading	Graders	1	8.00	187	0.41
Grading	Rubber Tired Dozers	1	8.00	247	0.40
Grading	Scrapers	2	8.00	367	0.48
Grading	Tractors/Loaders/Backhoes	2	8.00	97	0.37
Building Construction	Aerial Lifts	2	8.00	63	0.31
Building Construction	Cranes	2	7.00	231	0.29
Building Construction	Rough Terrain Forklifts	2	8.00	100	0.40
Building Construction	Tractors/Loaders/Backhoes	3	7.00	97	0.37
Building Construction	Welders	1	8.00	46	0.45
Paving	Pavers	2	8.00	130	0.42
Paving	Paving Equipment	2	8.00	132	0.36
Paving	Rollers	2	8.00	80	0.38
Architectural Coating	Air Compressors	1	6.00	78	0.48

**Trips and VMI**

Green Valley Logistics (Imperial County) - Mitigated - Imperial County, Annual

**EMFAC Off-Model Adjustment Factors for Gasoline Light Duty Vehicle to Account for the SAFE Vehicle Rule Applied**

Phase Name	Offroad Equipment Count	Worker Trip Number	Vendor Trip Number	Hauling Trip Number	Worker Trip Length	Vendor Trip Length	Hauling Trip Length	Worker Vehicle Class	Vendor Vehicle Class	Hauling Vehicle Class
Site Preparation	7	18.00	0.00	125.00	7.30	8.90	20.00	LD_Mix	HDT_Mix	HHDT
Grading	8	20.00	0.00	2,965.35	7.30	8.90	20.00	LD_Mix	HDT_Mix	HHDT
Building Construction	10	501.00	195.00	21,284.65	7.30	8.90	20.00	LD_Mix	HDT_Mix	HHDT
Paving	6	15.00	0.00	0.00	7.30	8.90	20.00	LD_Mix	HDT_Mix	HHDT
Architectural Coating	1	100.00	0.00	0.00	7.30	8.90	20.00	LD_Mix	HDT_Mix	HHDT

**3.1 Mitigation Measures Construction**

- Use Cleaner Engines for Construction Equipment
- Use DPF for Construction Equipment
- Water Exposed Area
- Water Unpaved Roads
- Reduce Vehicle Speed on Unpaved Roads

**3.2 Site Preparation - 2024**

**Unmitigated Construction On-Site**

EEC ORIGINAL PKG

Category	ROG	NOx	CO	SO2	Fugitive PM10	Exhaust PM10	PM10 Total	Fugitive PM2.5	Exhaust PM2.5	PM2.5 Total	Biogenic CO2	NBHC-CO2	Total CO2	CH4	N2O	CO2e
	tons/yr															
Flammable Dust					0.4424	0.0000	0.4424	0.2273	0.0000	0.2273	0.0000	0.0000	0.0000	0.0000	0.0000	0.0000
Off-Road	0.0599	0.6115	0.4126	8.6000e-004	0.0277	0.0277	0.0277	0.0255	0.0255	0.0255	0.0000	75.2784	75.2784	0.0244	0.0000	75.8871
<b>Total</b>	<b>0.0599</b>	<b>0.6115</b>	<b>0.4126</b>	<b>8.6000e-004</b>	<b>0.4424</b>	<b>0.0277</b>	<b>0.4700</b>	<b>0.2273</b>	<b>0.0255</b>	<b>0.2528</b>	<b>0.0000</b>	<b>75.2784</b>	<b>75.2784</b>	<b>0.0244</b>	<b>0.0000</b>	<b>75.8871</b>



Green Valley Logistics (Imperial County) - Mitigated - Imperial County, Annual

**EMFAC Off-Model Adjustment Factors for Gasoline Light Duty Vehicle to Account for the SAFE Vehicle Rule Applied**

**3.2 Site Preparation - 2024**

**Unmitigated Construction Off-Site**

Category	tons/yr										MT/yr					
	ROG	NOx	CO	SO2	Fugitive PM10	Exhaust PM10	PM10 Total	Fugitive PM2.5	Exhaust PM2.5	PM2.5 Total	Bio- CO2	NBio- CO2	Total CO2	CH4	N2O	CO2e
Hauling	1.4000e-004	6.4800e-003	1.8200e-003	3.0000e-005	1.0900e-003	8.0000e-005	1.1700e-003	3.0000e-004	7.0000e-005	3.7000e-004	0.0000	3.1914	3.1914	1.0000e-005	5.0000e-004	3.3411
Vendor	0.0000	0.0000	0.0000	0.0000	0.0000	0.0000	0.0000	0.0000	0.0000	0.0000	0.0000	0.0000	0.0000	0.0000	0.0000	0.0000
Worker	1.2900e-003	6.7000e-004	8.0900e-003	2.0000e-005	2.2300e-003	1.0000e-005	2.2500e-003	5.9000e-004	1.0000e-005	6.0000e-004	0.0000	1.7488	1.7488	7.0000e-005	6.0000e-005	1.7679
<b>Total</b>	<b>1.4300e-003</b>	<b>7.1500e-003</b>	<b>9.9100e-003</b>	<b>5.0000e-005</b>	<b>3.3200e-003</b>	<b>9.0000e-005</b>	<b>3.4200e-003</b>	<b>8.9000e-004</b>	<b>8.0000e-005</b>	<b>9.7000e-004</b>	<b>0.0000</b>	<b>4.9402</b>	<b>4.9402</b>	<b>8.0000e-005</b>	<b>5.6000e-004</b>	<b>5.1090</b>

**Mitigated Construction On-Site**

**EFC ORIGINAL PKG**

Category	tons/yr										MT/yr					
	ROG	NOx	CO	SO2	Fugitive PM10	Exhaust PM10	PM10 Total	Fugitive PM2.5	Exhaust PM2.5	PM2.5 Total	Bio- CO2	NBio- CO2	Total CO2	CH4	N2O	CO2e
Fugitive Dust					0.1991	0.0000	0.1991	0.1023	0.0000	0.1023	0.0000	0.0000	0.0000	0.0000	0.0000	0.0000
Off-Road	0.0210	0.4290	0.5166	8.6000e-004		3.1900e-003	3.1900e-003		3.1900e-003	3.1900e-003	0.0000	75.2783	75.2783	0.0244	0.0000	75.8870
<b>Total</b>	<b>0.0210</b>	<b>0.4290</b>	<b>0.5166</b>	<b>8.6000e-004</b>	<b>0.1991</b>	<b>3.1900e-003</b>	<b>0.2023</b>	<b>0.1023</b>	<b>3.1900e-003</b>	<b>0.1055</b>	<b>0.0000</b>	<b>75.2783</b>	<b>75.2783</b>	<b>0.0244</b>	<b>0.0000</b>	<b>75.8870</b>



Green Valley Logistics (Imperial County) - Mitigated - Imperial County, Annual

**EMFAC Off-Model Adjustment Factors for Gasoline Light Duty Vehicle to Account for the SAFE Vehicle Rule Applied**

**3.2 Site Preparation - 2024**

Mitigated Construction Off-Site

Category	tons/yr										MT/yr					
	ROG	NOx	CO	SO2	Fugitive PM10	Exhaust PM10	PM10 Total	Fugitive PM2.5	Exhaust PM2.5	PM2.5 Total	Bio- CO2	NBio- CO2	Total CO2	CH4	N2O	CO2e
Hauling	1.4000e-004	6.4800e-003	1.8200e-003	3.0000e-005	1.0900e-003	8.0000e-005	1.1700e-003	3.0000e-004	7.0000e-005	3.7000e-004	0.0000	3.1914	3.1914	1.0000e-005	5.0000e-004	3.3411
Vendor	0.0000	0.0000	0.0000	0.0000	0.0000	0.0000	0.0000	0.0000	0.0000	0.0000	0.0000	0.0000	0.0000	0.0000	0.0000	0.0000
Worker	1.2900e-003	6.7000e-004	8.0900e-003	2.0000e-005	2.2300e-003	1.0000e-005	2.2500e-003	5.9000e-004	1.0000e-005	6.0000e-004	0.0000	1.7488	1.7488	7.0000e-005	6.0000e-005	1.7679
<b>Total</b>	<b>1.4300e-003</b>	<b>7.1500e-003</b>	<b>9.9100e-003</b>	<b>5.0000e-005</b>	<b>3.3200e-003</b>	<b>9.0000e-005</b>	<b>3.4200e-003</b>	<b>8.9000e-004</b>	<b>8.0000e-005</b>	<b>9.7000e-004</b>	<b>0.0000</b>	<b>4.9402</b>	<b>4.9402</b>	<b>8.0000e-005</b>	<b>5.6000e-004</b>	<b>5.1090</b>

**3.3 Grading - 2024**

Unmitigated Construction On-Site

Category	tons/yr										MT/yr					
	ROG	NOx	CO	SO2	Fugitive PM10	Exhaust PM10	PM10 Total	Fugitive PM2.5	Exhaust PM2.5	PM2.5 Total	Bio- CO2	NBio- CO2	Total CO2	CH4	N2O	CO2e
Fugitive Dust					0.2071	0.0000	0.2071	0.0822	0.0000	0.0822	0.0000	0.0000	0.0000	0.0000	0.0000	0.0000
Off-Road	0.0724	0.7285	0.6238	1.4000e-003		0.0301	0.0301		0.0276	0.0276	0.0000	122.6689	122.6689	0.0397	0.0000	123.6608
<b>Total</b>	<b>0.0724</b>	<b>0.7285</b>	<b>0.6238</b>	<b>1.4000e-003</b>	<b>0.2071</b>	<b>0.0301</b>	<b>0.2371</b>	<b>0.0822</b>	<b>0.0276</b>	<b>0.1099</b>	<b>0.0000</b>	<b>122.6689</b>	<b>122.6689</b>	<b>0.0397</b>	<b>0.0000</b>	<b>123.6608</b>

EFC ORIGINAL PKG

Green Valley Logistics (Imperial County) - Mitigated - Imperial County, Annual

**EMFAC Off-Model Adjustment Factors for Gasoline Light Duty Vehicle to Account for the SAFE Vehicle Rule Applied**

**3.3 Grading - 2024**

**Unmitigated Construction Off-Site**

Category	tons/yr											MT/yr				
	ROG	NOx	CO	SO2	Fugitive PM10	Exhaust PM10	PM10 Total	Fugitive PM2.5	Exhaust PM2.5	PM2.5 Total	Bio- CO2	NBio- CO2	Total CO2	CH4	N2O	CO2e
Hauling	3.4400e-003	0.1537	0.0432	7.9000e-004	0.0259	1.8000e-003	0.0277	7.1000e-003	1.7300e-003	8.8200e-003	0.0000	75.7248	75.7248	2.1000e-004	0.0119	79.2774
Vendor	0.0000	0.0000	0.0000	0.0000	0.0000	0.0000	0.0000	0.0000	0.0000	0.0000	0.0000	0.0000	0.0000	0.0000	0.0000	0.0000
Worker	1.4400e-003	7.4000e-004	8.9900e-003	2.0000e-005	2.4800e-003	1.0000e-005	2.4900e-003	6.6000e-004	1.0000e-005	6.7000e-004	0.0000	1.9431	1.9431	7.0000e-005	7.0000e-005	1.9644
<b>Total</b>	<b>4.8800e-003</b>	<b>0.1544</b>	<b>0.0522</b>	<b>8.1000e-004</b>	<b>0.0283</b>	<b>1.8100e-003</b>	<b>0.0301</b>	<b>7.7600e-003</b>	<b>1.7400e-003</b>	<b>9.4900e-003</b>	<b>0.0000</b>	<b>77.6679</b>	<b>77.6679</b>	<b>2.8000e-004</b>	<b>0.0120</b>	<b>81.2418</b>

**Mitigated Construction On-Site**

Category	tons/yr											MT/yr				
	ROG	NOx	CO	SO2	Fugitive PM10	Exhaust PM10	PM10 Total	Fugitive PM2.5	Exhaust PM2.5	PM2.5 Total	Bio- CO2	NBio- CO2	Total CO2	CH4	N2O	CO2e
Fugitive Dust					0.0932	0.0000	0.0932	0.0370	0.0000	0.0370	0.0000	0.0000	0.0000	0.0000	0.0000	0.0000
Off-Road	0.0343	0.6745	0.8263	1.4000e-003		4.3900e-003	4.3900e-003		4.3900e-003	4.3900e-003	0.0000	122.6688	122.6688	0.0397	0.0000	123.6606
<b>Total</b>	<b>0.0343</b>	<b>0.6745</b>	<b>0.8263</b>	<b>1.4000e-003</b>	<b>0.0932</b>	<b>4.3900e-003</b>	<b>0.0976</b>	<b>0.0370</b>	<b>4.3900e-003</b>	<b>0.0414</b>	<b>0.0000</b>	<b>122.6688</b>	<b>122.6688</b>	<b>0.0397</b>	<b>0.0000</b>	<b>123.6606</b>

EEC ORIGINAL PKG

Green Valley Logistics (Imperial County) - Mitigated - Imperial County, Annual

**EMFAC Off-Model Adjustment Factors for Gasoline Light Duty Vehicle to Account for the SAFE Vehicle Rule Applied**

**3.3 Grading - 2024**

Mitigated Construction Off-Site

Category	tons/yr											MT/yr				
	ROG	NOx	CO	SO2	Fugitive PM10	Exhaust PM10	PM10 Total	Fugitive PM2.5	Exhaust PM2.5	PM2.5 Total	Bio- CO2	NBio- CO2	Total CO2	CH4	N2O	CO2e
Hauling	3.4400e-003	0.1537	0.0432	7.9000e-004	0.0259	1.8000e-003	0.0277	7.1000e-003	1.7300e-003	8.8200e-003	0.0000	75.7248	75.7248	2.1000e-004	0.0119	79.2774
Vendor	0.0000	0.0000	0.0000	0.0000	0.0000	0.0000	0.0000	0.0000	0.0000	0.0000	0.0000	0.0000	0.0000	0.0000	0.0000	0.0000
Worker	1.4400e-003	7.4000e-004	8.9900e-003	2.0000e-005	2.4800e-003	1.0000e-005	2.4900e-003	6.6000e-004	1.0000e-005	6.7000e-004	0.0000	1.9431	1.9431	7.0000e-005	7.0000e-005	1.9644
<b>Total</b>	<b>4.8800e-003</b>	<b>0.1544</b>	<b>0.0522</b>	<b>8.1000e-004</b>	<b>0.0283</b>	<b>1.8100e-003</b>	<b>0.0301</b>	<b>7.7600e-003</b>	<b>1.7400e-003</b>	<b>9.4900e-003</b>	<b>0.0000</b>	<b>77.6679</b>	<b>77.6679</b>	<b>2.8000e-004</b>	<b>0.0120</b>	<b>81.2418</b>

**3.4 Building Construction - 2024**

Unmitigated Construction On-Site

Category	tons/yr											MT/yr				
	ROG	NOx	CO	SO2	Fugitive PM10	Exhaust PM10	PM10 Total	Fugitive PM2.5	Exhaust PM2.5	PM2.5 Total	Bio- CO2	NBio- CO2	Total CO2	CH4	N2O	CO2e
Off-Road	0.1424	1.4616	1.6880	3.0200e-003		0.0560	0.0560		0.0519	0.0519	0.0000	261.3720	261.3720	0.0805	0.0000	263.3843
<b>Total</b>	<b>0.1424</b>	<b>1.4616</b>	<b>1.6880</b>	<b>3.0200e-003</b>		<b>0.0560</b>	<b>0.0560</b>		<b>0.0519</b>	<b>0.0519</b>	<b>0.0000</b>	<b>261.3720</b>	<b>261.3720</b>	<b>0.0805</b>	<b>0.0000</b>	<b>263.3843</b>

EFC ORIGINAL FKG

Green Valley Logistics (Imperial County) - Mitigated - Imperial County, Annual

**EMFAC Off-Model Adjustment Factors for Gasoline Light Duty Vehicle to Account for the SAFE Vehicle Rule Applied**

**3.4 Building Construction - 2024  
Unmitigated Construction Off-Site**

Category	tons/yr											MT/yr				
	ROG	NOx	CO	SO2	Fugitive PM10	Exhaust PM10	PM10 Total	Fugitive PM2.5	Exhaust PM2.5	PM2.5 Total	Bio- CO2	NBio- CO2	Total CO2	CH4	N2O	CO2e
Hauling	0.0148	0.6623	0.1863	3.4000e-003	0.1114	7.7800e-003	0.1192	0.0306	7.4400e-003	0.0380	0.0000	326.3922	326.3922	9.1000e-004	0.0513	341.7047
Vendor	0.0374	0.7732	0.3561	4.2700e-003	0.1554	6.9800e-003	0.1624	0.0448	6.6800e-003	0.0515	0.0000	407.4348	407.4348	1.7900e-003	0.0561	424.1925
Worker	0.1551	0.0800	0.9707	2.2400e-003	0.2681	1.3400e-003	0.2694	0.0712	1.2300e-003	0.0724	0.0000	209.8438	209.8438	7.8500e-003	7.0500e-003	212.1400
<b>Total</b>	<b>0.2073</b>	<b>1.5155</b>	<b>1.5132</b>	<b>9.9100e-003</b>	<b>0.5349</b>	<b>0.0161</b>	<b>0.5510</b>	<b>0.1465</b>	<b>0.0154</b>	<b>0.1619</b>	<b>0.0000</b>	<b>943.6708</b>	<b>943.6708</b>	<b>0.0106</b>	<b>0.1144</b>	<b>978.0372</b>

**Mitigated Construction On-Site**

Category	tons/yr											MT/yr				
	ROG	NOx	CO	SO2	Fugitive PM10	Exhaust PM10	PM10 Total	Fugitive PM2.5	Exhaust PM2.5	PM2.5 Total	Bio- CO2	NBio- CO2	Total CO2	CH4	N2O	CO2e
Off-Road	0.0781	1.6290	2.0166	3.0200e-003		0.0146	0.0146		0.0146	0.0146	0.0000	261.3717	261.3717	0.0805	0.0000	263.3840
<b>Total</b>	<b>0.0781</b>	<b>1.6290</b>	<b>2.0166</b>	<b>3.0200e-003</b>		<b>0.0146</b>	<b>0.0146</b>		<b>0.0146</b>	<b>0.0146</b>	<b>0.0000</b>	<b>261.3717</b>	<b>261.3717</b>	<b>0.0805</b>	<b>0.0000</b>	<b>263.3840</b>

EFC ORIGINAL PKG



Green Valley Logistics (Imperial County) - Mitigated - Imperial County, Annual

**EMFAC Off-Model Adjustment Factors for Gasoline Light Duty Vehicle to Account for the SAFE Vehicle Rule Applied**

**3.4 Building Construction - 2024**

**Mitigated Construction Off-Site**

Category	tons/yr										MT/yr					
	ROG	NOx	CO	SO2	Fugitive PM10	Exhaust PM10	PM10 Total	Fugitive PM2.5	Exhaust PM2.5	PM2.5 Total	Bio- CO2	NBio- CO2	Total CO2	CH4	N2O	CO2e
Hauling	0.0148	0.6623	0.1863	3.4000e-003	0.1114	7.7800e-003	0.1192	0.0306	7.4400e-003	0.0380	0.0000	326.3922	326.3922	9.1000e-004	0.0513	341.7047
Vendor	0.0374	0.7732	0.3561	4.2700e-003	0.1554	6.9800e-003	0.1624	0.0448	6.6800e-003	0.0515	0.0000	407.4348	407.4348	1.7900e-003	0.0561	424.1925
Worker	0.1551	0.0800	0.9707	2.2400e-003	0.2681	1.3400e-003	0.2694	0.0712	1.2300e-003	0.0724	0.0000	209.8436	209.8436	7.8500e-003	7.0500e-003	212.1400
<b>Total</b>	<b>0.2073</b>	<b>1.5155</b>	<b>1.5132</b>	<b>9.9100e-003</b>	<b>0.5349</b>	<b>0.0161</b>	<b>0.5510</b>	<b>0.1465</b>	<b>0.0154</b>	<b>0.1619</b>	<b>0.0000</b>	<b>943.6708</b>	<b>943.6708</b>	<b>0.0106</b>	<b>0.1144</b>	<b>978.0372</b>

**3.4 Building Construction - 2025**

**Unmitigated Construction On-Site**

Category	tons/yr										MT/yr					
	ROG	NOx	CO	SO2	Fugitive PM10	Exhaust PM10	PM10 Total	Fugitive PM2.5	Exhaust PM2.5	PM2.5 Total	Bio- CO2	NBio- CO2	Total CO2	CH4	N2O	CO2e
Off-Road	0.0888	0.9030	1.1156	2.0100e-003		0.0328	0.0328		0.0304	0.0304	0.0000	173.8431	173.8431	0.0535	0.0000	175.1794
<b>Total</b>	<b>0.0888</b>	<b>0.9030</b>	<b>1.1156</b>	<b>2.0100e-003</b>		<b>0.0328</b>	<b>0.0328</b>		<b>0.0304</b>	<b>0.0304</b>	<b>0.0000</b>	<b>173.8431</b>	<b>173.8431</b>	<b>0.0535</b>	<b>0.0000</b>	<b>175.1794</b>

EEC ORIGINAL FKG



Green Valley Logistics (Imperial County) - Mitigated - Imperial County, Annual

**EMFAC Off-Model Adjustment Factors for Gasoline Light Duty Vehicle to Account for the SAFE Vehicle Rule Applied**

**3.4 Building Construction - 2025  
Unmitigated Construction Off-Site**

Category	tons/yr											MT/yr				
	ROG	NOx	CO	SO2	Fugitive PM10	Exhaust PM10	PM10 Total	Fugitive PM2.5	Exhaust PM2.5	PM2.5 Total	Bio- CO2	NBio- CO2	Total CO2	CH4	N2O	CO2e
Hauling	9.8400e-003	0.4346	0.1241	2.2100e-003	0.0741	5.1400e-003	0.0792	0.0203	4.9200e-003	0.0253	0.0000	212.0364	212.0364	6.3000e-004	0.0333	221.9848
Vendor	0.0242	0.5069	0.2301	2.7900e-003	0.1033	4.6200e-003	0.1079	0.0298	4.4200e-003	0.0342	0.0000	266.2257	266.2257	1.1700e-003	0.0364	277.1063
Worker	0.0959	0.0476	0.5975	1.4400e-003	0.1783	8.4000e-004	0.1791	0.0473	7.7000e-004	0.0481	0.0000	136.1131	136.1131	4.7200e-003	4.3600e-003	137.5292
<b>Total</b>	<b>0.1300</b>	<b>0.9891</b>	<b>0.9517</b>	<b>6.4400e-003</b>	<b>0.3557</b>	<b>0.0106</b>	<b>0.3663</b>	<b>0.0974</b>	<b>0.0101</b>	<b>0.1075</b>	<b>0.0000</b>	<b>614.3752</b>	<b>614.3752</b>	<b>6.5200e-003</b>	<b>0.0741</b>	<b>636.6203</b>

**Mitigated Construction On-Site**

Category	tons/yr											MT/yr				
	ROG	NOx	CO	SO2	Fugitive PM10	Exhaust PM10	PM10 Total	Fugitive PM2.5	Exhaust PM2.5	PM2.5 Total	Bio- CO2	NBio- CO2	Total CO2	CH4	N2O	CO2e
Off-Road	0.0520	1.0832	1.3410	2.0100e-003		9.7400e-003	9.7400e-003		9.7400e-003	9.7400e-003	0.0000	173.8429	173.8429	0.0535	0.0000	175.1792
<b>Total</b>	<b>0.0520</b>	<b>1.0832</b>	<b>1.3410</b>	<b>2.0100e-003</b>		<b>9.7400e-003</b>	<b>9.7400e-003</b>		<b>9.7400e-003</b>	<b>9.7400e-003</b>	<b>0.0000</b>	<b>173.8429</b>	<b>173.8429</b>	<b>0.0535</b>	<b>0.0000</b>	<b>175.1792</b>

Green Valley Logistics (Imperial County) - Mitigated - Imperial County, Annual

**EMFAC Off-Model Adjustment Factors for Gasoline Light Duty Vehicle to Account for the SAFE Vehicle Rule Applied**

**3.4 Building Construction - 2025**

Mitigated Construction Off-Site

Category	tons/yr										MT/yr					
	ROG	NOx	CO	SO2	Fugitive PM10	Exhaust PM10	PM10 Total	Fugitive PM2.5	Exhaust PM2.5	PM2.5 Total	Bio- CO2	NBio- CO2	Total CO2	CH4	N2O	CO2e
Hauling	9.8400e-003	0.4346	0.1241	2.2100e-003	0.0741	5.1400e-003	0.0792	0.0203	4.9200e-003	0.0253	0.0000	212.0364	212.0364	6.3000e-004	0.0333	221.9848
Vendor	0.0242	0.5069	0.2301	2.7900e-003	0.1033	4.6200e-003	0.1079	0.0298	4.4200e-003	0.0342	0.0000	266.2257	266.2257	1.1700e-003	0.0364	277.1063
Worker	0.0959	0.0476	0.5975	1.4400e-003	0.1783	8.4000e-004	0.1791	0.0473	7.7000e-004	0.0481	0.0000	136.1131	136.1131	4.7200e-003	4.3600e-003	137.5292
<b>Total</b>	<b>0.1300</b>	<b>0.9891</b>	<b>0.9517</b>	<b>6.4400e-003</b>	<b>0.3557</b>	<b>0.0106</b>	<b>0.3663</b>	<b>0.0974</b>	<b>0.0101</b>	<b>0.1075</b>	<b>0.0000</b>	<b>614.3752</b>	<b>614.3752</b>	<b>6.5200e-003</b>	<b>0.0741</b>	<b>636.6203</b>

**3.5 Paving - 2024**

Unmitigated Construction On-Site

Category	tons/yr										MT/yr					
	ROG	NOx	CO	SO2	Fugitive PM10	Exhaust PM10	PM10 Total	Fugitive PM2.5	Exhaust PM2.5	PM2.5 Total	Bio- CO2	NBio- CO2	Total CO2	CH4	N2O	CO2e
Off-Road	0.0124	0.1191	0.1828	2.9000e-004		5.8600e-003	5.8600e-003		5.3900e-003	5.3900e-003	0.0000	25.0332	25.0332	8.1000e-003	0.0000	25.2356
Paving	5.2400e-003					0.0000	0.0000		0.0000	0.0000	0.0000	0.0000	0.0000	0.0000	0.0000	0.0000
<b>Total</b>	<b>0.0176</b>	<b>0.1191</b>	<b>0.1828</b>	<b>2.9000e-004</b>		<b>5.8600e-003</b>	<b>5.8600e-003</b>		<b>5.3900e-003</b>	<b>5.3900e-003</b>	<b>0.0000</b>	<b>25.0332</b>	<b>25.0332</b>	<b>8.1000e-003</b>	<b>0.0000</b>	<b>25.2356</b>

EEC ORIGINAL PKG

Green Valley Logistics (Imperial County) - Mitigated - Imperial County, Annual

**EMFAC Off-Model Adjustment Factors for Gasoline Light Duty Vehicle to Account for the SAFE Vehicle Rule Applied**

**3.5 Paving - 2024**

**Unmitigated Construction Off-Site**

Category	tons/yr										MT/yr					
	ROG	NOx	CO	SO2	Fugitive PM10	Exhaust PM10	PM10 Total	Fugitive PM2.5	Exhaust PM2.5	PM2.5 Total	Bio- CO2	NBio- CO2	Total CO2	CH4	N2O	CO2e
Hauling	0.0000	0.0000	0.0000	0.0000	0.0000	0.0000	0.0000	0.0000	0.0000	0.0000	0.0000	0.0000	0.0000	0.0000	0.0000	0.0000
Vendor	0.0000	0.0000	0.0000	0.0000	0.0000	0.0000	0.0000	0.0000	0.0000	0.0000	0.0000	0.0000	0.0000	0.0000	0.0000	0.0000
Worker	6.0000e-004	3.1000e-004	3.7500e-003	1.0000e-005	1.0300e-003	1.0000e-005	1.0400e-003	2.7000e-004	0.0000	2.8000e-004	0.0000	0.8096	0.8096	3.0000e-005	3.0000e-005	0.8185
<b>Total</b>	<b>6.0000e-004</b>	<b>3.1000e-004</b>	<b>3.7500e-003</b>	<b>1.0000e-005</b>	<b>1.0300e-003</b>	<b>1.0000e-005</b>	<b>1.0400e-003</b>	<b>2.7000e-004</b>	<b>0.0000</b>	<b>2.8000e-004</b>	<b>0.0000</b>	<b>0.8096</b>	<b>0.8096</b>	<b>3.0000e-005</b>	<b>3.0000e-005</b>	<b>0.8185</b>

**Mitigated Construction On-Site**

Category	tons/yr										MT/yr					
	ROG	NOx	CO	SO2	Fugitive PM10	Exhaust PM10	PM10 Total	Fugitive PM2.5	Exhaust PM2.5	PM2.5 Total	Bio- CO2	NBio- CO2	Total CO2	CH4	N2O	CO2e
Off-Road	7.0100e-003	0.1412	0.2162	2.9000e-004	1.1400e-003	1.1400e-003	1.1400e-003	1.1400e-003	1.1400e-003	1.1400e-003	0.0000	25.0331	25.0331	8.1000e-003	0.0000	25.2355
Paving	5.2400e-003				0.0000	0.0000	0.0000	0.0000	0.0000	0.0000	0.0000	0.0000	0.0000	0.0000	0.0000	0.0000
<b>Total</b>	<b>0.0123</b>	<b>0.1412</b>	<b>0.2162</b>	<b>2.9000e-004</b>	<b>1.1400e-003</b>	<b>1.1400e-003</b>	<b>1.1400e-003</b>	<b>1.1400e-003</b>	<b>1.1400e-003</b>	<b>1.1400e-003</b>	<b>0.0000</b>	<b>25.0331</b>	<b>25.0331</b>	<b>8.1000e-003</b>	<b>0.0000</b>	<b>25.2355</b>

**EFC ORIGINAL PKG**

Green Valley Logistics (Imperial County) - Mitigated - Imperial County, Annual

**EMFAC Off-Model Adjustment Factors for Gasoline Light Duty Vehicle to Account for the SAFE Vehicle Rule Applied**

**3.5 Paving - 2024**

**Mitigated Construction Off-Site**

Category	tons/yr										MT/yr					
	ROG	NOx	CO	SO2	Fugitive PM10	Exhaust PM10	PM10 Total	Fugitive PM2.5	Exhaust PM2.5	PM2.5 Total	Bio- CO2	NBio- CO2	Total CO2	CH4	N2O	CO2e
Hauling	0.0000	0.0000	0.0000	0.0000	0.0000	0.0000	0.0000	0.0000	0.0000	0.0000	0.0000	0.0000	0.0000	0.0000	0.0000	0.0000
Vendor	0.0000	0.0000	0.0000	0.0000	0.0000	0.0000	0.0000	0.0000	0.0000	0.0000	0.0000	0.0000	0.0000	0.0000	0.0000	0.0000
Worker	6.0000e-004	3.1000e-004	3.7500e-003	1.0000e-005	1.0300e-003	1.0000e-005	1.0400e-003	2.7000e-004	0.0000	2.8000e-004	0.0000	0.8096	0.8096	3.0000e-005	3.0000e-005	0.8185
<b>Total</b>	<b>6.0000e-004</b>	<b>3.1000e-004</b>	<b>3.7500e-003</b>	<b>1.0000e-005</b>	<b>1.0300e-003</b>	<b>1.0000e-005</b>	<b>1.0400e-003</b>	<b>2.7000e-004</b>	<b>0.0000</b>	<b>2.8000e-004</b>	<b>0.0000</b>	<b>0.8096</b>	<b>0.8096</b>	<b>3.0000e-005</b>	<b>3.0000e-005</b>	<b>0.8185</b>

**3.6 Architectural Coating - 2024**

**Unmitigated Construction On-Site**

Category	tons/yr										MT/yr					
	ROG	NOx	CO	SO2	Fugitive PM10	Exhaust PM10	PM10 Total	Fugitive PM2.5	Exhaust PM2.5	PM2.5 Total	Bio- CO2	NBio- CO2	Total CO2	CH4	N2O	CO2e
Archit. Coating	4.3091					0.0000	0.0000	0.0000	0.0000	0.0000	0.0000	0.0000	0.0000	0.0000	0.0000	0.0000
Off-Road	0.0119	0.0804	0.1195	2.0000e-004	4.0200e-003	4.0200e-003	4.0200e-003	4.0200e-003	4.0200e-003	4.0200e-003	0.0000	16.8515	16.8515	9.5000e-004	0.0000	16.8752
<b>Total</b>	<b>4.3210</b>	<b>0.0804</b>	<b>0.1195</b>	<b>2.0000e-004</b>	<b>4.0200e-003</b>	<b>4.0200e-003</b>	<b>4.0200e-003</b>	<b>4.0200e-003</b>	<b>4.0200e-003</b>	<b>4.0200e-003</b>	<b>0.0000</b>	<b>16.8515</b>	<b>16.8515</b>	<b>9.5000e-004</b>	<b>0.0000</b>	<b>16.8752</b>

EEC ORIGINAL PKG



Green Valley Logistics (Imperial County) - Mitigated - Imperial County, Annual

**EMFAC Off-Model Adjustment Factors for Gasoline Light Duty Vehicle to Account for the SAFE Vehicle Rule Applied**

**3.6 Architectural Coating - 2024  
Unmitigated Construction Off-Site**

Category	tons/yr										MT/yr					
	ROG	NOx	CO	SO2	Fugitive PM10	Exhaust PM10	PM10 Total	Fugitive PM2.5	Exhaust PM2.5	PM2.5 Total	Bio- CO2	NBio- CO2	Total CO2	CH4	N2O	CO2e
Hauling	0.0000	0.0000	0.0000	0.0000	0.0000	0.0000	0.0000	0.0000	0.0000	0.0000	0.0000	0.0000	0.0000	0.0000	0.0000	0.0000
Vendor	0.0000	0.0000	0.0000	0.0000	0.0000	0.0000	0.0000	0.0000	0.0000	0.0000	0.0000	0.0000	0.0000	0.0000	0.0000	0.0000
Worker	0.0211	0.0109	0.1318	3.0000e-004	0.0364	1.8000e-004	0.0366	9.6600e-003	1.7000e-004	9.8300e-003	0.0000	28.4991	28.4991	1.0700e-003	9.6000e-004	28.8109
<b>Total</b>	<b>0.0211</b>	<b>0.0109</b>	<b>0.1318</b>	<b>3.0000e-004</b>	<b>0.0364</b>	<b>1.8000e-004</b>	<b>0.0366</b>	<b>9.6600e-003</b>	<b>1.7000e-004</b>	<b>9.8300e-003</b>	<b>0.0000</b>	<b>28.4991</b>	<b>28.4991</b>	<b>1.0700e-003</b>	<b>9.6000e-004</b>	<b>28.8109</b>

**Mitigated Construction On-Site**

Category	tons/yr										MT/yr					
	ROG	NOx	CO	SO2	Fugitive PM10	Exhaust PM10	PM10 Total	Fugitive PM2.5	Exhaust PM2.5	PM2.5 Total	Bio- CO2	NBio- CO2	Total CO2	CH4	N2O	CO2e
Archit. Coating	4.3091					0.0000	0.0000	0.0000	0.0000	0.0000	0.0000	0.0000	0.0000	0.0000	0.0000	0.0000
Off-Road	3.9200e-003	0.0896	0.1209	2.0000e-004		9.4000e-004		9.4000e-004		9.4000e-004	0.0000	16.8515	16.8515	9.5000e-004	0.0000	16.8752
<b>Total</b>	<b>4.3130</b>	<b>0.0896</b>	<b>0.1209</b>	<b>2.0000e-004</b>		<b>9.4000e-004</b>		<b>9.4000e-004</b>		<b>9.4000e-004</b>	<b>0.0000</b>	<b>16.8515</b>	<b>16.8515</b>	<b>9.5000e-004</b>	<b>0.0000</b>	<b>16.8752</b>

EFC ORIGINAL PKG



Green Valley Logistics (Imperial County) - Mitigated - Imperial County, Annual

**EMFAC Off-Model Adjustment Factors for Gasoline Light Duty Vehicle to Account for the SAFE Vehicle Rule Applied**

**3.6 Architectural Coating - 2024**

**Mitigated Construction Off-Site**

Category	tons/yr										MT/yr						
	ROG	NOx	CO	SO2	Fugitive PM10	Exhaust PM10	PM10 Total	Fugitive PM2.5	Exhaust PM2.5	PM2.5 Total	Bio- CO2	NBio- CO2	Total CO2	CH4	N2O	CO2e	
Hauling	0.0000	0.0000	0.0000	0.0000	0.0000	0.0000	0.0000	0.0000	0.0000	0.0000	0.0000	0.0000	0.0000	0.0000	0.0000	0.0000	0.0000
Vendor	0.0000	0.0000	0.0000	0.0000	0.0000	0.0000	0.0000	0.0000	0.0000	0.0000	0.0000	0.0000	0.0000	0.0000	0.0000	0.0000	0.0000
Worker	0.0211	0.0109	0.1318	3.0000e-004	0.0364	1.8000e-004	0.0366	9.6600e-003	1.7000e-004	9.8300e-003	0.0000	28.4991	28.4991	1.0700e-003	9.6000e-004	28.8109	28.8109
<b>Total</b>	<b>0.0211</b>	<b>0.0109</b>	<b>0.1318</b>	<b>3.0000e-004</b>	<b>0.0364</b>	<b>1.8000e-004</b>	<b>0.0366</b>	<b>9.6600e-003</b>	<b>1.7000e-004</b>	<b>9.8300e-003</b>	<b>0.0000</b>	<b>28.4991</b>	<b>28.4991</b>	<b>1.0700e-003</b>	<b>9.6000e-004</b>	<b>28.8109</b>	<b>28.8109</b>

**3.6 Architectural Coating - 2025**

**Unmitigated Construction On-Site**

Category	tons/yr										MT/yr						
	ROG	NOx	CO	SO2	Fugitive PM10	Exhaust PM10	PM10 Total	Fugitive PM2.5	Exhaust PM2.5	PM2.5 Total	Bio- CO2	NBio- CO2	Total CO2	CH4	N2O	CO2e	
Archit. Coating	3.0359				0.0000	0.0000	0.0000	0.0000	0.0000	0.0000	0.0000	0.0000	0.0000	0.0000	0.0000	0.0000	0.0000
Off-Road	7.9400e-003	0.0533	0.0841	1.4000e-004	2.4000e-003	2.4000e-003	2.4000e-003	2.4000e-003	2.4000e-003	2.4000e-003	0.0000	11.8726	11.8726	6.5000e-004	0.0000	11.8888	11.8888
<b>Total</b>	<b>3.0439</b>	<b>0.0533</b>	<b>0.0841</b>	<b>1.4000e-004</b>	<b>2.4000e-003</b>	<b>2.4000e-003</b>	<b>2.4000e-003</b>	<b>2.4000e-003</b>	<b>2.4000e-003</b>	<b>2.4000e-003</b>	<b>0.0000</b>	<b>11.8726</b>	<b>11.8726</b>	<b>6.5000e-004</b>	<b>0.0000</b>	<b>11.8888</b>	<b>11.8888</b>

EEC ORIGINAL PKG

Green Valley Logistics (Imperial County) - Mitigated - Imperial County, Annual

**EMFAC Off-Model Adjustment Factors for Gasoline Light Duty Vehicle to Account for the SAFE Vehicle Rule Applied**

**3.6 Architectural Coating - 2025  
Unmitigated Construction Off-Site**

Category	tons/yr											MT/yr				
	ROG	NOx	CO	SO2	Fugitive PM10	Exhaust PM10	PM10 Total	Fugitive PM2.5	Exhaust PM2.5	PM2.5 Total	Bio- CO2	NBio- CO2	Total CO2	CH4	N2O	CO2e
Hauling	0.0000	0.0000	0.0000	0.0000	0.0000	0.0000	0.0000	0.0000	0.0000	0.0000	0.0000	0.0000	0.0000	0.0000	0.0000	0.0000
Vendor	0.0000	0.0000	0.0000	0.0000	0.0000	0.0000	0.0000	0.0000	0.0000	0.0000	0.0000	0.0000	0.0000	0.0000	0.0000	0.0000
Worker	0.0138	6.8400e-003	0.0860	2.1000e-004	0.0257	1.2000e-004	0.0258	6.8100e-003	1.1000e-004	6.9200e-003	0.0000	19.5864	19.5864	6.8000e-004	6.3000e-004	19.7902
<b>Total</b>	<b>0.0138</b>	<b>6.8400e-003</b>	<b>0.0860</b>	<b>2.1000e-004</b>	<b>0.0257</b>	<b>1.2000e-004</b>	<b>0.0258</b>	<b>6.8100e-003</b>	<b>1.1000e-004</b>	<b>6.9200e-003</b>	<b>0.0000</b>	<b>19.5864</b>	<b>19.5864</b>	<b>6.8000e-004</b>	<b>6.3000e-004</b>	<b>19.7902</b>

**Mitigated Construction On-Site**

Category	tons/yr											MT/yr				
	ROG	NOx	CO	SO2	Fugitive PM10	Exhaust PM10	PM10 Total	Fugitive PM2.5	Exhaust PM2.5	PM2.5 Total	Bio- CO2	NBio- CO2	Total CO2	CH4	N2O	CO2e
Appl. Coating	3.0359					0.0000	0.0000		0.0000	0.0000	0.0000	0.0000	0.0000	0.0000	0.0000	0.0000
Off-Road	2.7600e-003	0.0631	0.0852	1.4000e-004		6.6000e-004	6.6000e-004		6.6000e-004	6.6000e-004	0.0000	11.8726	11.8726	6.5000e-004	0.0000	11.8888
<b>Total</b>	<b>3.0387</b>	<b>0.0631</b>	<b>0.0852</b>	<b>1.4000e-004</b>		<b>6.6000e-004</b>	<b>6.6000e-004</b>		<b>6.6000e-004</b>	<b>6.6000e-004</b>	<b>0.0000</b>	<b>11.8726</b>	<b>11.8726</b>	<b>6.5000e-004</b>	<b>0.0000</b>	<b>11.8888</b>

FEC ORIGINAL PKG

Green Valley Logistics (Imperial County) - Mitigated - Imperial County, Annual

**EMFAC Off-Model Adjustment Factors for Gasoline Light Duty Vehicle to Account for the SAFE Vehicle Rule Applied**

**3.6 Architectural Coating - 2025**

Mitigated Construction Off-Site

Category	tons/yr										MT/yr					
	ROG	NOx	CO	SO2	Fugitive PM10	Exhaust PM10	PM10 Total	Fugitive PM2.5	Exhaust PM2.5	PM2.5 Total	Bio- CO2	NBio- CO2	Total CO2	CH4	N2O	CO2e
Hauling	0.0000	0.0000	0.0000	0.0000	0.0000	0.0000	0.0000	0.0000	0.0000	0.0000	0.0000	0.0000	0.0000	0.0000	0.0000	0.0000
Vendor	0.0000	0.0000	0.0000	0.0000	0.0000	0.0000	0.0000	0.0000	0.0000	0.0000	0.0000	0.0000	0.0000	0.0000	0.0000	0.0000
Worker	0.0138	6.8400e-003	0.0860	2.1000e-004	0.0257	1.2000e-004	0.0258	6.8100e-003	1.1000e-004	6.9200e-003	0.0000	19.5864	19.5864	6.8000e-004	6.3000e-004	19.7902
<b>Total</b>	<b>0.0138</b>	<b>6.8400e-003</b>	<b>0.0860</b>	<b>2.1000e-004</b>	<b>0.0257</b>	<b>1.2000e-004</b>	<b>0.0258</b>	<b>6.8100e-003</b>	<b>1.1000e-004</b>	<b>6.9200e-003</b>	<b>0.0000</b>	<b>19.5864</b>	<b>19.5864</b>	<b>6.8000e-004</b>	<b>6.3000e-004</b>	<b>19.7902</b>

**4.0 Operational Detail - Mobile**

**4.1 Mitigation Measures Mobile**

EC ORIGINAL PKG

Green Valley Logistics (Imperial County) - Mitigated - Imperial County, Annual

**EMFAC Off-Model Adjustment Factors for Gasoline Light Duty Vehicle to Account for the SAFE Vehicle Rule Applied**

Category	tons/yr											MT/yr				
	ROG	NOx	CO	SO2	Fugitive PM10	Exhaust PM10	PM10 Total	Fugitive PM2.5	Exhaust PM2.5	PM2.5 Total	Blk- CO2	NBlk- CO2	Total CO2	CH4	N2O	CO2e
Mitigated	4.6100e-003	2.9700e-003	0.0481	1.4000e-004	1.9135	8.0000e-005	1.9135	0.1935	7.0000e-005	0.1936	0.0000	13.0005	13.0005	3.9000e-004	3.8000e-004	13.1219
Unmitigated	4.6100e-003	2.9700e-003	0.0481	1.4000e-004	1.9135	8.0000e-005	1.9135	0.1935	7.0000e-005	0.1936	0.0000	13.0005	13.0005	3.9000e-004	3.8000e-004	13.1219

**4.2 Trip Summary Information**

Land Use	Average Daily Trip Rate			Unmitigated Annual VMT	Mitigated Annual VMT
	Weekday	Saturday	Sunday		
Convenience Market with Gas Pumps	0.00	0.00	0.00		
General Heavy Industry	21.50	21.50	21.50	50,947	50,947
Parking Lot	0.00	0.00	0.00		
Unrefrigerated Warehouse-Rail	0.00	0.00	0.00		
<b>Total</b>	<b>21.50</b>	<b>21.50</b>	<b>21.50</b>	<b>50,947</b>	<b>50,947</b>

**4.3 Trip Type Information**

Land Use	Miles				Trip %				Trip Purpose %			
	H-W or C-W	H-S or C-C	H-O or C-NW	H-W or C-W	H-S or C-C	H-O or C-NW	Primary	Diverted	Pass-by			
Convenience Market with Gas	6.70	5.00	8.90	0.80	80.20	19.00	0	0	0			
General Heavy Industry	6.70	5.00	8.90	59.00	28.00	13.00	100	0	0			
Parking Lot	6.70	5.00	8.90	0.00	0.00	0.00	0	0	0			
Unrefrigerated Warehouse-Rail	6.70	5.00	8.90	59.00	0.00	41.00	0	0	0			

**4.4 Fleet Mix**



Green Valley Logistics (Imperial County) - Mitigated - Imperial County, Annual

**EMFAC Off-Model Adjustment Factors for Gasoline Light Duty Vehicle to Account for the SAFE Vehicle Rule Applied**

Land Use	LDA	LDT1	LDT2	MDV	LHD1	LHD2	MHD	HHD	OBUS	UBUS	MCY	SBUS	MH
Convenience Market with Gas Pumps	0.530702	0.059328	0.179664	0.144474	0.026250	0.006790	0.008325	0.016302	0.000941	0.000118	0.022966	0.000752	0.003388
General Heavy Industry	1.000000	0.000000	0.000000	0.000000	0.000000	0.000000	0.000000	0.000000	0.000000	0.000000	0.000000	0.000000	0.000000
Parking Lot	0.530702	0.059328	0.179664	0.144474	0.026250	0.006790	0.008325	0.016302	0.000941	0.000118	0.022966	0.000752	0.003388
Unrefrigerated Warehouse-Rail	0.530702	0.059328	0.179664	0.144474	0.026250	0.006790	0.008325	0.016302	0.000941	0.000118	0.022966	0.000752	0.003388

**5.0 Energy Detail**

Historical Energy Use: N

**5.1 Mitigation Measures Energy**

Category	tons/yr										MT/yr					
	ROG	NOx	CO	SO2	Fugitive PM10	Exhaust PM10	PM10 Total	Fugitive PM2.5	Exhaust PM2.5	PM2.5 Total	Bio-CO2	NBio-CO2	Total CO2	CH4	N2O	CO2e
Electricity Mitigated						0.0000	0.0000		0.0000	0.0000	0.0000	249.2501	249.2501	0.0433	5.2500e-003	251.8963
Electricity Unmitigated						0.0000	0.0000		0.0000	0.0000	0.0000	249.2501	249.2501	0.0433	5.2500e-003	251.8963
Natural Gas Mitigated	0.0196	0.1780	0.1495	1.0700e-003		0.0135	0.0135	0.0135	0.0135	0.0135	0.0000	193.7890	193.7890	3.7100e-003	3.5500e-003	194.9406
Natural Gas Unmitigated	0.0196	0.1780	0.1495	1.0700e-003		0.0135	0.0135	0.0135	0.0135	0.0135	0.0000	193.7890	193.7890	3.7100e-003	3.5500e-003	194.9406

ELC ORIGINAL PKG



Green Valley Logistics (Imperial County) - Mitigated - Imperial County, Annual

**EMFAC Off-Model Adjustment Factors for Gasoline Light Duty Vehicle to Account for the SAFE Vehicle Rule Applied**

**5.2 Energy by Land Use - Natural Gas**

**Unmitigated**

Land Use	Natural Gas Use kBtu/yr	tons/yr										MT/yr					
		ROG	NOx	CO	SO2	Fugitive PM10	Exhaust PM10	PM10 Total	Fugitive PM2.5	Exhaust PM2.5	PM2.5 Total	Bio- CO2	NBio- CO2	Total CO2	CH4	N2O	CO2e
Convenience Market with Gas Pumps	4969.36	3.0000e-005	2.4000e-004	2.0000e-004	0.0000	2.0000e-005	2.0000e-005	2.0000e-005	2.0000e-005	2.0000e-005	2.0000e-005	0.0000	0.2652	0.2652	1.0000e-005	0.0000	0.2668
General Heavy Industry	1.6165e+006	8.7200e-003	0.0792	0.0866	4.8000e-004	6.0200e-003	6.0200e-003	6.0200e-003	6.0200e-003	6.0200e-003	6.0200e-003	0.0000	86.2626	86.2626	1.6500e-003	1.5800e-003	86.7752
Parking Lot	0	0.0000	0.0000	0.0000	0.0000	0.0000	0.0000	0.0000	0.0000	0.0000	0.0000	0.0000	0.0000	0.0000	0.0000	0.0000	0.0000
Unrefrigerated Warehouse-Rail	2.01e+006	0.0108	0.0985	0.0828	5.9000e-004	7.4900e-003	7.4900e-003	7.4900e-003	7.4900e-003	7.4900e-003	7.4900e-003	0.0000	107.2613	107.2613	2.0600e-003	1.9700e-003	107.8987
<b>Total</b>		<b>0.0196</b>	<b>0.1780</b>	<b>0.1495</b>	<b>1.0700e-003</b>	<b>0.0135</b>	<b>0.0135</b>	<b>0.0135</b>	<b>0.0135</b>	<b>0.0135</b>	<b>0.0135</b>	<b>0.0000</b>	<b>193.7890</b>	<b>193.7890</b>	<b>3.7200e-003</b>	<b>3.5500e-003</b>	<b>194.9406</b>

Green Valley Logistics (Imperial County) - Mitigated - Imperial County, Annual

**EMFAC Off-Model Adjustment Factors for Gasoline Light Duty Vehicle to Account for the SAFE Vehicle Rule Applied**

**5.2 Energy by Land Use - Natural Gas**

**Mitigated**

Land Use	Natural Gas Use kBTU/yr	tons/yr										MT/yr					
		ROG	NOx	CO	SO2	Fugitive PM10	Exhaust PM10	PM10 Total	Fugitive PM2.5	Exhaust PM2.5	PM2.5 Total	Bio- CO2	NIbio- CO2	Total CO2	CH4	N2O	CO2e
Convenience Market with Gas Pumps	4969.36	3.0000e-005	2.4000e-004	2.0000e-004	0.0000		2.0000e-005		2.0000e-005	2.0000e-005	2.0000e-005	0.0000	0.2652	1.0000e-005	0.0000	0.0000	0.2668
General Heavy Industry	1.6165e+006	8.7200e-003	0.0792	0.0666	4.8000e-004	6.0200e-003	6.0200e-003	6.0200e-003	6.0200e-003	6.0200e-003	6.0200e-003	0.0000	86.2626	1.6500e-003	1.5600e-003	1.5600e-003	86.7752
Parking Lot	0	0.0000	0.0000	0.0000	0.0000	0.0000	0.0000	0.0000	0.0000	0.0000	0.0000	0.0000	0.0000	0.0000	0.0000	0.0000	0.0000
Unrefrigerated Warehouse-Rail	2.01e+006	0.0108	0.0985	0.0828	5.9000e-004	7.4900e-003	7.4900e-003	7.4900e-003	7.4900e-003	7.4900e-003	7.4900e-003	0.0000	107.2613	2.0600e-003	1.9700e-003	1.9700e-003	107.9987
<b>Total</b>		<b>0.0196</b>	<b>0.1780</b>	<b>0.1495</b>	<b>1.0700e-003</b>	<b>0.0135</b>	<b>0.0135</b>	<b>0.0135</b>	<b>0.0135</b>	<b>0.0135</b>	<b>0.0135</b>	<b>0.0000</b>	<b>193.7890</b>	<b>3.7200e-003</b>	<b>3.5500e-003</b>	<b>3.5500e-003</b>	<b>194.9406</b>

**EMFAC Off-Model Adjustment Factors for Gasoline Light Duty Vehicle to Account for the SAFE Vehicle Rule Applied**

**5.3 Energy by Land Use - Electricity**

**Unmitigated**

Land Use	Electricity Use	Total CO2	CH4	N2O	CO2e
	kWh/yr	MT/yr			
Convenience Market with Gas Pumps	27421.8	2.3630	4.1000e-004	5.0000e-005	2.3881
General Heavy Industry	496000	42.7421	7.4200e-003	9.0000e-004	43.1958
Parking Lot	49000	4.2225	7.3000e-004	9.0000e-005	4.2673
Unrefrigerated Warehouse-Rail	2.32e+006	199.9225	0.0347	4.2100e-003	202.0450
<b>Total</b>		<b>249.2501</b>	<b>0.0433</b>	<b>5.2500e-003</b>	<b>251.8963</b>

Green Valley Logistics (Imperial County) - Mitigated - Imperial County, Annual

**EMFAC Off-Model Adjustment Factors for Gasoline Light Duty Vehicle to Account for the SAFE Vehicle Rule Applied**

**5.3 Energy by Land Use - Electricity**

**Mitigated**

Land Use	Electricity Use	Total CO2	CH4	N2O	CO2e
	kWh/yr	MT/yr			
Convenience Market with Gas Pumps	27421.8	2.3630	4.1000e-004	5.0000e-005	2.3881
General Heavy Industry	496000	42.7421	7.4200e-003	9.0000e-004	43.1958
Parking Lot	49000	4.2225	7.3000e-004	9.0000e-005	4.2673
Unrefrigerated Warehouse-Rail	2.32e+006	199.9225	0.0347	4.2100e-003	202.0450
<b>Total</b>		<b>249.2501</b>	<b>0.0433</b>	<b>5.2500e-003</b>	<b>251.8963</b>

**6.0 Area Detail**

**6.1 Mitigation Measures Area**

FF ORIGINAL PKG

Green Valley Logistics (Imperial County) - Mitigated - Imperial County, Annual

**EMFAC Off-Model Adjustment Factors for Gasoline Light Duty Vehicle to Account for the SAFE Vehicle Rule Applied**

Category	tons/yr										MT/yr					
	ROG	NOx	CO	SO2	Fugitive PM10	Exhaust PM10	PM10 Total	Fugitive PM2.5	Exhaust PM2.5	PM2.5 Total	Bio- CO2	NBio- CO2	Total CO2	CH4	N2O	CO2e
Mitigated	4.8543	1.2000e-004	0.0130	0.0000	5.0000e-005	5.0000e-005	5.0000e-005	5.0000e-005	5.0000e-005	5.0000e-005	0.0000	0.0253	0.0253	7.0000e-005	0.0000	0.0270
Unmitigated	4.8543	1.2000e-004	0.0130	0.0000	5.0000e-005	5.0000e-005	5.0000e-005	5.0000e-005	5.0000e-005	5.0000e-005	0.0000	0.0253	0.0253	7.0000e-005	0.0000	0.0270

**6.2 Area by SubCategory**

Unmitigated

SubCategory	tons/yr										MT/yr					
	ROG	NOx	CO	SO2	Fugitive PM10	Exhaust PM10	PM10 Total	Fugitive PM2.5	Exhaust PM2.5	PM2.5 Total	Bio- CO2	NBio- CO2	Total CO2	CH4	N2O	CO2e
Architectural Coating	0.7345				0.0000	0.0000	0.0000	0.0000	0.0000	0.0000	0.0000	0.0000	0.0000	0.0000	0.0000	0.0000
Consumer Products	4.1187				0.0000	0.0000	0.0000	0.0000	0.0000	0.0000	0.0000	0.0000	0.0000	0.0000	0.0000	0.0000
Landscaping	1.1900e-003	1.2000e-004	0.0130	0.0000	5.0000e-005	5.0000e-005	5.0000e-005	5.0000e-005	5.0000e-005	5.0000e-005	0.0000	0.0253	0.0253	7.0000e-005	0.0000	0.0270
<b>Total</b>	<b>4.8543</b>	<b>1.2000e-004</b>	<b>0.0130</b>	<b>0.0000</b>	<b>5.0000e-005</b>	<b>5.0000e-005</b>	<b>5.0000e-005</b>	<b>5.0000e-005</b>	<b>5.0000e-005</b>	<b>5.0000e-005</b>	<b>0.0000</b>	<b>0.0253</b>	<b>0.0253</b>	<b>7.0000e-005</b>	<b>0.0000</b>	<b>0.0270</b>

**FEC ORIGINAL PKG**



Green Valley Logistics (Imperial County) - Mitigated - Imperial County, Annual

**EMFAC Off-Model Adjustment Factors for Gasoline Light Duty Vehicle to Account for the SAFE Vehicle Rule Applied**

**6.2 Area by SubCategory**

**Mitigated**

SubCategory	ROG	NOx	CO	SO2	tons/yr					MT/yr							
					Fugitive PM10	Exhaust PM10	PM10 Total	Fugitive PM2.5	Exhaust PM2.5	PM2.5 Total	Bio- CO2	NBio- CO2	Total CO2	CH4	N2O	CO2e	
Architectural Coating	0.7345					0.0000	0.0000	0.0000		0.0000	0.0000	0.0000	0.0000	0.0000	0.0000	0.0000	0.0000
Consumer Products	4.1187					0.0000	0.0000	0.0000		0.0000	0.0000	0.0000	0.0000	0.0000	0.0000	0.0000	0.0000
Landscaping	1.1900e-003	1.2000e-004	0.0130	0.0000		5.0000e-005	5.0000e-005	5.0000e-005		5.0000e-005	5.0000e-005	5.0000e-005	0.0253	7.0000e-005	0.0000	0.0000	0.0270
<b>Total</b>	<b>4.8543</b>	<b>1.2000e-004</b>	<b>0.0130</b>	<b>0.0000</b>		<b>5.0000e-005</b>	<b>5.0000e-005</b>	<b>5.0000e-005</b>		<b>5.0000e-005</b>	<b>5.0000e-005</b>	<b>5.0000e-005</b>	<b>0.0253</b>	<b>7.0000e-005</b>	<b>0.0000</b>	<b>0.0000</b>	<b>0.0270</b>

**7.0 Water Detail**

**7.1 Mitigation Measures Water**

**EEC ORIGINAL PKG**

Green Valley Logistics (Imperial County) - Mitigated - Imperial County, Annual

**EMFAC Off-Model Adjustment Factors for Gasoline Light Duty Vehicle to Account for the SAFE Vehicle Rule Applied**

Category	Total CO2	CH4	N2O	CO2e
Mitigated	61.9339	0.4011	0.0105	75.0780
Unmitigated	61.9339	0.4011	0.0105	75.0780

**7.2 Water by Land Use**

**Unmitigated**

Land Use	Indoor/Outdoor Use	Total CO2	CH4	N2O	CO2e
Convenience Market with Gas Pumps	0 / 0	0.0000	0.0000	0.0000	0.0000
General Heavy Industry	0 / 0	0.0000	0.0000	0.0000	0.0000
Parking Lot	0 / 0	0.0000	0.0000	0.0000	0.0000
Unrefrigerated Warehouse-Rail	12 / 46.65	61.9339	0.4011	0.0105	75.0780
<b>Total</b>		<b>61.9339</b>	<b>0.4011</b>	<b>0.0105</b>	<b>75.0780</b>

TEC ORIGINAL PKG

Green Valley Logistics (Imperial County) - Mitigated - Imperial County, Annual

**EMFAC Off-Model Adjustment Factors for Gasoline Light Duty Vehicle to Account for the SAFE Vehicle Rule Applied**

**7.2 Water by Land Use**

**Mitigated**

Land Use	Indoor/Outdoor Use	Mgal	MITIGATED			
			Total CO2	CH4	N2O	CO2e
Convenience Market with Gas Pumps	0 / 0	0.0000	0.0000	0.0000	0.0000	0.0000
General Heavy Industry	0 / 0	0.0000	0.0000	0.0000	0.0000	0.0000
Parking Lot	0 / 0	0.0000	0.0000	0.0000	0.0000	0.0000
Unrefrigerated Warehouse-Rail	12 / 46.65	61.9339	0.4011	0.0105	75.0780	
<b>Total</b>		<b>61.9339</b>	<b>0.4011</b>	<b>0.0105</b>	<b>75.0780</b>	

**8.0 Waste Detail**

**8.1 Mitigation Measures Waste**

EEC ORIGINAL PKG

Green Valley Logistics (Imperial County) - Mitigated - Imperial County, Annual

**EMFAC Off-Model Adjustment Factors for Gasoline Light Duty Vehicle to Account for the SAFE Vehicle Rule Applied**

Category/Year

	Total CO2	CH4	N2O	CO2e
	MT/yr			
Mitigated	50.7477	2.9991	0.0000	125.7254
Unmitigated	50.7477	2.9991	0.0000	125.7254

**8.2 Waste by Land Use**

Unmitigated

Land Use	Waste Disposed tons	Total CO2	CH4	N2O	CO2e
General Heavy Industry	62	12.5854	0.7438	0.0000	31.1799
Parking Lot	0	0.0000	0.0000	0.0000	0.0000
Unrefrigerated Warehouse-Rail	188	38.1623	2.2553	0.0000	94.5455
<b>Total</b>		<b>50.7477</b>	<b>2.9991</b>	<b>0.0000</b>	<b>125.7254</b>

TEC ORIGINAL PKG

**EMFAC Off-Model Adjustment Factors for Gasoline Light Duty Vehicle to Account for the SAFE Vehicle Rule Applied**

**8.2 Waste by Land Use**

Mitigated

Land Use	Waste Disposed tons	Total CO2	CH4	N2O	CO2e
General Heavy Industry	62	12.5854	0.7438	0.0000	31.1799
Parking Lot	0	0.0000	0.0000	0.0000	0.0000
Unrefrigerated Warehouse-Rail	188	38.1623	2.2553	0.0000	94.5455
<b>Total</b>		<b>50.7477</b>	<b>2.9991</b>	<b>0.0000</b>	<b>125.7254</b>

**9.0 Operational Offroad**

Equipment Type	Number	Hours/Day	Days/Year	Horse Power	Load Factor	Fuel Type
----------------	--------	-----------	-----------	-------------	-------------	-----------

**10.0 Stationary Equipment**

Fire Pumps and Emergency Generators

Equipment Type	Number	Hours/Day	Hours/Year	Horse Power	Load Factor	Fuel Type
----------------	--------	-----------	------------	-------------	-------------	-----------

Boilers

Equipment Type	Number	Heat Input/Day	Heat Input/Year	Boiler Rating	Fuel Type
----------------	--------	----------------	-----------------	---------------	-----------

User Defined Equipment

Equipment Type	Number
----------------	--------

RECORGINA PKG



Green Valley Logistics (Imperial County) - Mitigated - Imperial County, Annual

**EMFAC Off-Model Adjustment Factors for Gasoline Light Duty Vehicle to Account for the SAFE Vehicle Rule Applied**

**11.0 Vegetation**

---

Attachment B - Locomotive and Operations Emissions Calculation

Locomotive Emission Inventories for the United States from ERTAC Rail

Source: <https://www3.epa.gov/ttnchie1/conference/ei20/session8/mbergin.pdf>

**Table 1. Summary of ERTAC Rail Inventories: U.S. Locomotive Emissions and Fuel Use for either 2007 or 2008\*.**

	Fuel Use** (gal/yr)	Emissions (tons/yr)						
		NO <sub>x</sub>	PM <sub>2.5</sub>	HC	SO <sub>2</sub>	CO	NH <sub>3</sub>	CO <sub>2</sub>
Class I*** line-haul	3,770,914,002	754,443	23,439	37,941	7,836	110,969	347	42,305k
Class I switcher	301,046,290	74,431	2,042	4,867	624	9,230	28	3,367k
Class II and III	157,800,000	47,035	1,065	1,737	327	4,631	14	1,765k

\*See Appendix B for a description of the year and source of data utilized for each inventory.

\*\*Locomotive grade diesel

\*\*\*Excluding Amtrak and including work train fuel use

	Fuel Use (Gal/Yr)	CO2 (tons/year)	CO2 (Tons/Gal)	CO2 MT/Gal
Class 1 - Line Haul	3,770,914,002	42,305,000	0.011218766	0.010177496
Class 1 - Switcher	301,046,290	3,367,000	0.011184327	0.010146253

Conversion Factor (bhp-hr/gal) 15.20

See: EPA-420-F-09-025 April 2009

Number of Locomotives per Day 4 locomotives

Total power per locomotive 4000.00 horsepower/locomotive

Gallons consumed per Hour per Locomotive 263.16 gallons/hr/locomotive

Time within Project per locomotive 1.75 hours/trip

Gallons consumed within Project per locomotive 460.53 gallons/Trip

Total Fuel Consumed per Day 1842.11 Gallons/day

Annual Fuel Consumed 672368.42 Gallons/year

MT GHG 6822.02 MT CO2/year

Project Operatons from CalEEMod 465.00 MT CO2/year

**Total GHG Emissions 7287.02 MT CO2/year**

# **NOISE ASSESSMENT**

**Green Valley  
Logistics Center Project  
County of Imperial, CA**

**Prepared for:**

**Chambers Group, Inc.  
5 Hutton Centre Dr, Suite 350  
Santa Ana, CA 92707**

***Prepared By:***

***Ldn Consulting, Inc.*  
42428 Chisolm Trail  
Murrieta, California 92562  
760-473-1253**

**July 18, 2023**

**Project: 21-170 Green Valley Logistics Noise**

**EEC ORIGINAL PKG**

## TABLE OF CONTENTS

TABLE OF CONTENTS .....	II
LIST OF FIGURES .....	III
LIST OF TABLES .....	III
GLOSSARY OF COMMON TERMS .....	IV
EXECUTIVE SUMMARY .....	V
<b>1.0 PROJECT INTRODUCTION .....</b>	<b>1</b>
1.1 PURPOSE OF THIS STUDY .....	1
1.2 PROJECT LOCATION .....	1
1.3 PROJECT DESCRIPTION AND PURPOSE .....	1
<b>2.0 FUNDAMENTALS .....</b>	<b>4</b>
2.1 ACOUSTICAL FUNDAMENTALS .....	4
2.2 VIBRATION FUNDAMENTALS .....	4
<b>3.0 SIGNIFICANCE THRESHOLDS AND STANDARDS .....</b>	<b>7</b>
3.1 OPERATIONAL STANDARDS .....	7
3.2 CONSTRUCTION NOISE STANDARDS .....	8
3.3 SIGNIFICANT INCREASE OF AMBIENT NOISE LEVELS .....	8
3.4 VIBRATION STANDARDS .....	9
<b>4.0 ENVIRONMENTAL SETTINGS &amp; EXISTING CONDITIONS .....</b>	<b>11</b>
4.1 SETTINGS & LOCATIONS .....	11
4.2 EXISTING NOISE CONDITIONS .....	11
4.3 NOISE MEASURING METHODOLOGY AND PROCEDURES .....	11
4.4 RECEIVER LOCATIONS .....	14
<b>5.0 CONSTRUCTION NOISE .....</b>	<b>15</b>
5.1 COUNTY OF IMPERIAL CONSTRUCTION STANDARDS .....	15
5.2 POTENTIAL PROJECT CONSTRUCTION NOISE IMPACTS .....	15
5.3 CONSTRUCTION VIBRATION .....	17
5.4 CONSTRUCTION CONCLUSIONS .....	18
<b>6.0 OPERATIONAL NOISE .....</b>	<b>19</b>
6.1 GUIDELINES FOR THE DETERMINATION OF SIGNIFICANCE .....	19
6.2 POTENTIAL OPERATIONAL NOISE IMPACTS .....	19
6.3 REFERENCE NOISE LEVELS .....	19
6.4 CUMULATIVE NOISE LEVELS .....	27
6.5 CONCLUSIONS .....	28
<b>7.0 TRANSPORTATION NOISE .....</b>	<b>29</b>
<b>8.0 REFERENCES .....</b>	<b>30</b>

## **LIST OF FIGURES**

FIGURE 1-A: PROJECT VICINITY MAP .....	2
FIGURE 1-B: PROJECT SITE PLAN .....	3
FIGURE 4-A: NOISE MEASUREMENT LOCATIONS.....	13
FIGURE 6-A: NOISE SOURCE LOCATIONS .....	20
FIGURE 6-B: PROJECT TRIP GENERATION .....	26

## **LIST OF TABLES**

TABLE 2-1: HUMAN REACTION TO TYPICAL VIBRATION LEVELS .....	6
TABLE 3-1: PROPERTY LINE NOISE LEVEL LIMITS.....	7
TABLE 3-2: VIBRATION AND NOISE IMPACT CRITERIA (HUMAN ANNOYANCE).....	9
TABLE 3-3: VIBRATION IMPACT CRITERIA (STRUCTURAL DAMAGE) .....	10
TABLE 4-1: EXISTING NOISE LEVELS.....	12
TABLE 5-1: CONSTRUCTION NOISE LEVELS .....	17
TABLE 5-2: VIBRATION LEVELS FROM CONSTRUCTION ACTIVITIES.....	18
TABLE 6-1: WATER TREATMENT NOISE LEVELS.....	21
TABLE 6-2: GRAIN ELEVATOR SYSTEM NOISE LEVELS.....	22
TABLE 6-3: FUELING STATION NOISE LEVELS .....	23
TABLE 6-4: TRANSLOADING NOISE LEVELS .....	27
TABLE 6-5: PROPERTY LINE NOISE LEVELS .....	28



## **GLOSSARY OF COMMON TERMS**

**Sound Pressure Level (SPL):** a ratio of one sound pressure to a reference pressure ( $L_{ref}$ ) of 20  $\mu$ Pa. Because of the dynamic range of the human ear, the ratio is calculated logarithmically by  $20 \log (L/L_{ref})$ .

**A-weighted Sound Pressure Level (dBA):** Some frequencies of noise are more noticeable than others. To compensate for this fact, different sound frequencies are weighted more.

**Minimum Sound Level ( $L_{min}$ ):** Minimum SPL or the lowest SPL measured over the time interval using the A-weighted network and slow time weighting.

**Maximum Sound Level ( $L_{max}$ ):** Maximum SPL or the highest SPL measured over the time interval the A-weighted network and slow time weighting.

**Equivalent sound level ( $L_{eq}$ ):** the true equivalent sound level measured over the run time.  $L_{eq}$  is the A-weighted steady sound level that contains the same total acoustical energy as the actual fluctuating sound level.

**Day Night Sound Level ( $L_{dn}$ ):** Representing the Day/Night sound level, this measurement is a 24 –hour average sound level where 10 dB is added to all the readings that occur between 10 pm and 7 am. This is primarily used in community noise regulations where there is a 10 dB “Penalty” for nighttime noise. Typically,  $L_{dn}$ ’s are measured using A weighting.

**Community Noise Exposure Level (CNEL):** The accumulated exposure to sound measured in a 24-hour sampling interval and artificially boosted during certain hours. For CNEL, samples taken between 7 pm and 10 pm are boosted by 5 dB; samples taken between 10 pm and 7 am are boosted by 10 dB.

**Octave Band:** An octave band is defined as a frequency band whose upper band-edge frequency is twice the lower band frequency.

**Third-Octave Band:** A third-octave band is defined as a frequency band whose upper band-edge frequency is 1.26 times the lower band frequency.

**Response Time (F,S,I):** The response time is a standardized exponential time weighting of the input signal according to fast (F), slow (S) or impulse (I) time response relationships. Time response can be described with a time constant. The time constants for fast, slow and impulse responses are 1.0 seconds, 0.125 seconds and 0.35 milliseconds, respectively.

## **EXECUTIVE SUMMARY**

This noise study has been completed to determine the noise impacts associated with the development of the proposed Green Valley Logistics Center Project in the County of Imperial, CA. The Project proposes the development and operation of three (3) rail loop tracks that tie into the adjacent Union Pacific Railroad right-of-way, including a ladder track and spurs ("rail system"). The rail system will facilitate in-bound and out-bound trains with commodities as well as transloading to and from trucks. The site includes a grain elevator for receiving and distributing corn and similar feed products for consumption by cattle feeder yards and similar.

### Construction Noise

At a distance of 0.25-miles from the nearest residence the point source noise attenuation from construction activities is a reduction of 28 dBA. This would result in an anticipated worst case eight-hour average combined noise level well below 75 dBA at the property line. Given this, the noise levels will comply with the County of Imperial's 75 dBA standard at all Project property lines and no impacts are anticipated.

There are no vibration-sensitive uses located adjacent to the proposed construction. The nearest offsite uses are residential and located over 0.25-miles from any construction activities. Project construction activities would not result in vibration induced structural damage or vibration induced annoyance to adjacent land uses. Therefore, vibration impacts would be less than significant.

### Operational Noise

Based on the empirical data and the distances to the property lines the unshielded noise levels from the proposed equipment were found to be below the County's most restrictive nighttime property line standard of 45 dBA. No impacts are anticipated and no mitigation is required.

### Off-Site Noise

The project does will not create a direct impact of more than 3 dBA CNEL on any roadway segment and no cumulative noise increase of 3 dBA CNEL or more were found. Therefore, the proposed project's direct and cumulative contributions to off-site roadway noise increases will not cause any significant impacts to any existing or future noise sensitive land uses.

## **1.0 PROJECT INTRODUCTION**

### **1.1 Purpose of this Study**

The purpose of this Noise study is to determine potential noise impacts (if any) created from the proposed construction and operation of the proposed project. Should impacts be determined, the intent of this study would be to recommend suitable mitigation measures to bring those impacts to a level that would be considered less than significant.

### **1.2 Project Location**

The Project would be located on approximately 285 gross acres within Imperial County (County), California, approximately 1.25 miles north of the City of Imperial. The Project would be west of the Union Pacific Railroad (UPRR), east of SR-86 (Imperial Avenue), north of Harris Road, and south of Newside Drain Number 1-A, entirely within the Mesquite Lake Specific Plan and on land owned by Tomcat Development LLC. The Project would be within Section 31 of Township 14 South, Range 14 East, San Bernardino Base Meridian, and Assessor Parcel Numbers (APNs) 040-340-004, 040-340-006, 040-340-032, and 040-340-033. A project vicinity map and location map are shown in Figure 1-A.

### **1.3 Project Description and Purpose**

The proposed Green Valley Logistics Center would allow for the development and operation of three (3) rail loop tracks totaling approximately 33,000 track feet, a rail ladder track totaling approximately 25,000 track feet, and an approximately 2,000 track feet spur that tie into the adjacent Union Pacific Railroad ROW ("rail system"). The Railroad Facility will facilitate inbound and outbound trains of commodities as well as the transloading of commodities to and from trucks. Near the tracks will be a warehousing building(s) and covered storage area(s). Also included in the Project are a grain elevator; shipping container depot, including but not limited to the function of hay/grain export; a veterans memorial area adjacent to the existing cemetery; a fuel blending / transloading area; a fueling station, including but not limited to Compressed Natural Gas (CNG), unleaded fuel, electrical vehicle chargers, hydrogen fueling and diesel; the extension of SoCal Gas's main line will be extended approximately 1.3 miles along State Route 86 to the Project site from Keystone Road to the north; warehousing; and areas for transloading and storage of commodities (Proposed Project). Further, the Project's Tentative Tract Map proposes to re-configure the existing parcels and a grant of road right-of way to the County for an Industrial Street. The Project also includes a specific plan amendment and zone change application to change land use and zoning from Light and Medium Industrial to Heavy Industrial. This analysis uses trip generation info from the Linscott Law & Greenspan traffic study for the Project dated April 26, 2023. The project site plan is shown on Figure 1-B of this report.

**Figure 1-A: Project Vicinity Map**

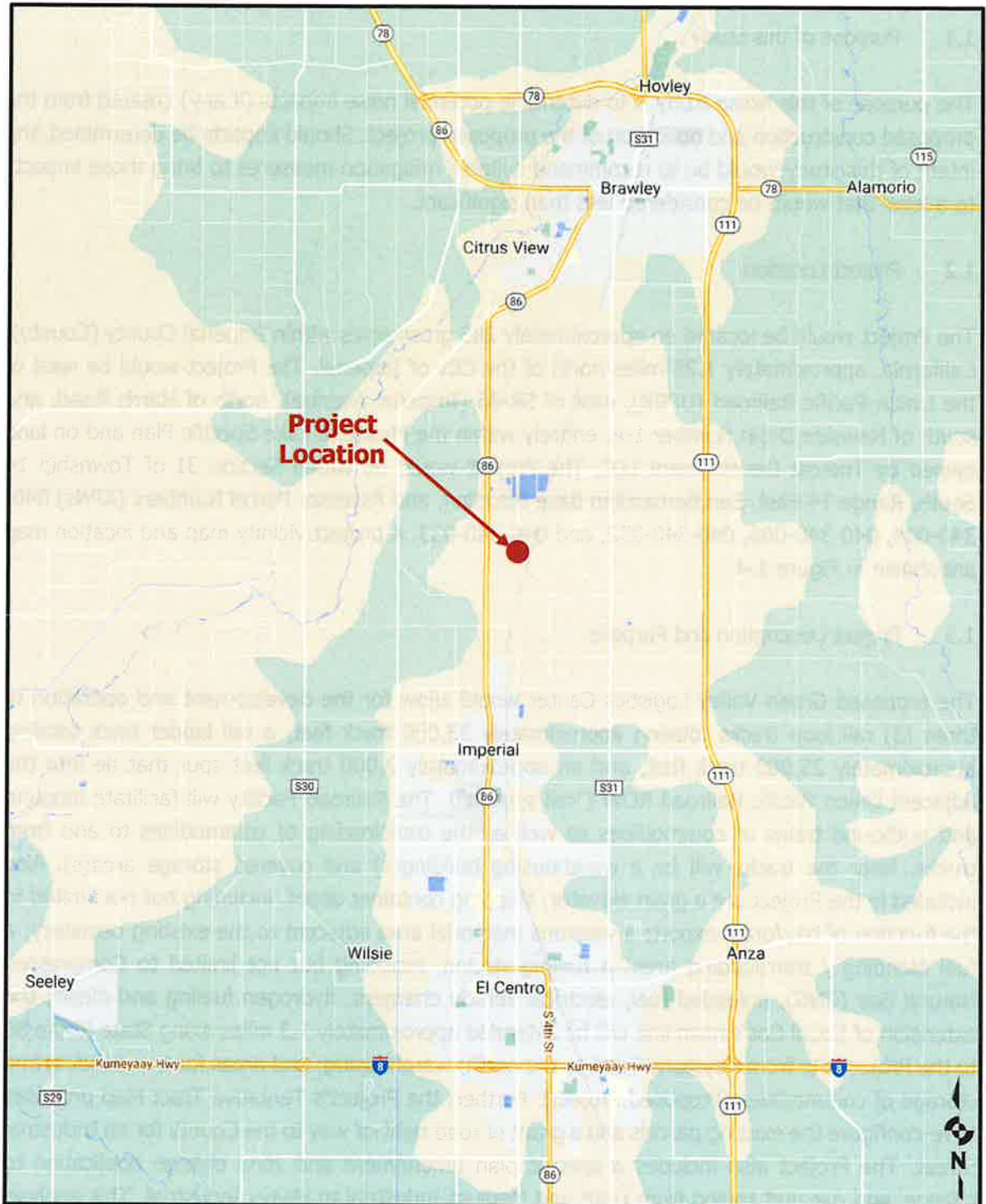

Source: (Google, 2023)

**Figure 1-B: Project Site Plan**

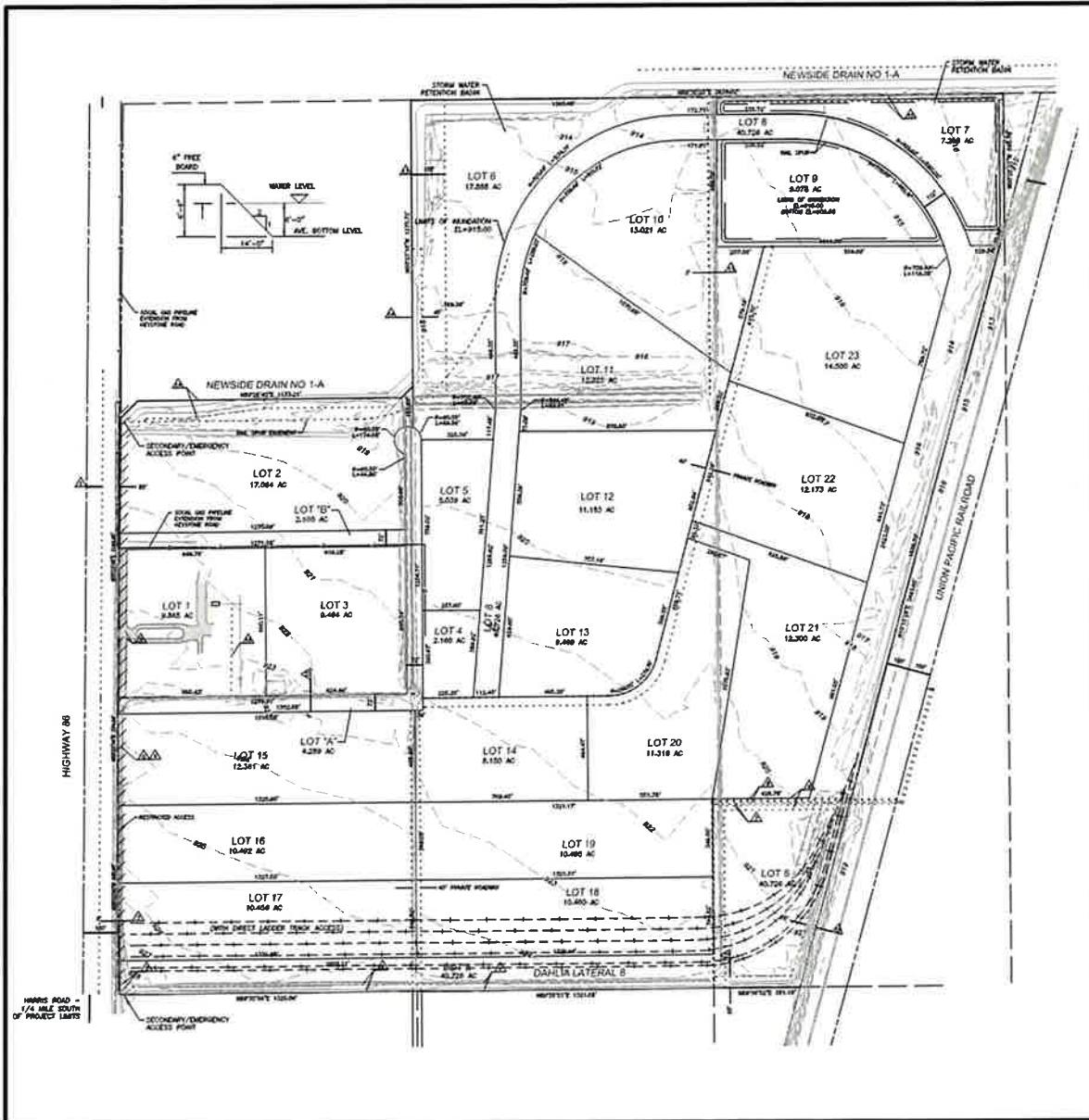

Source: (The Holt Group, Inc., 2023)



## **2.0 FUNDAMENTALS**

### 2.1 Acoustical Fundamentals

Noise is defined as unwanted or annoying sound which interferes with or disrupts normal activities. Exposure to high noise levels has been demonstrated to cause hearing loss. The individual human response to environmental noise is based on the sensitivity of that individual, the type of noise that occurs and when the noise occurs.

Sound is measured on a logarithmic scale consisting of sound pressure levels known as a decibel (dB). The sounds heard by humans typically do not consist of a single frequency but of a broadband of frequencies having different sound pressure levels. The method for evaluating all the frequencies of the sound is to apply an A-weighting to reflect how the human ear responds to the different sound levels at different frequencies. The A-weighted sound level adequately describes the instantaneous noise whereas the equivalent sound level depicted as  $L_{eq}$  represents a steady sound level containing the same total acoustical energy as the actual fluctuating sound level over a given time interval.

The U.S. Environmental Protection Agency (U.S. EPA) has compiled data regarding the noise generating characteristics of specific types of construction equipment. Noise levels generated by heavy construction equipment can range from 60 dBA to in excess of 100 dBA when measured at 50 feet. However, these noise levels diminish rapidly with distance from the construction site at a rate of approximately 6 dBA per doubling of distance. For example, a noise level of 75 dBA measured at 50 feet from the noise source to the receptor would be reduced to 69 dBA at 100 feet from the source to the receptor and reduced to 63 dBA at 200 feet from the source. The most effective noise reduction methods consist of controlling the noise at the source, blocking the noise transmission with barriers or relocating the receiver. Any or all of these methods may be required to reduce noise levels to an acceptable level.

The most effective noise reduction methods consist of controlling the noise at the source, blocking the noise transmission with barriers or relocating the receiver. Any or all of these methods may be required to reduce noise levels to an acceptable level.

### 2.2 Vibration Fundamentals

Vibration is a trembling or oscillating motion of the ground. Like noise, vibration is transmitted in waves, but in this case through the ground or solid objects. Unlike noise, vibration is typically felt rather than heard. Vibration can be either natural as in the form of earthquakes, volcanic eruptions, or manmade as from explosions, heavy machinery, or trains. Both natural and manmade vibration may be continuous, such as from operating machinery; or infrequent, as from an explosion.

As with noise, vibration can be described by both its amplitude and frequency. Amplitude may be characterized in three ways: displacement, velocity, and acceleration. Particle displacement is a measure of the distance that a vibrated particle travels from its original position and for the purposes of soil displacement is typically measured in inches or millimeters. Particle velocity is the rate of speed at which soil particles move in inches per second or millimeters per second. Particle acceleration is the rate of change in velocity with respect to time and is measured in inches per second or millimeters per second. Typically, particle velocity (measured in inches or millimeters per second) and/or acceleration (measured in gravities) are used to describe vibration. Table 2-1 shows the human reaction to various levels of peak particle velocity.

Vibrations also vary in frequency and this affects perception. Typical construction vibrations fall in the 10 to 30 Hz range and usually occurring around 15 Hz. Traffic vibrations exhibit a similar range of frequencies; however, due to their suspension systems, it is less common, to measure traffic frequencies above 30 Hz.

Propagation of ground-borne vibrations is complicated and difficult to predict because of the endless variations in the soil through which the waves travel. There are three main types of vibration propagation: surface, compression, and shear waves. Surface waves, or Rayleigh waves, travel along the ground's surface. These waves carry most of their energy along an expanding circular wave front, similar to ripples produced by dropping an object into water. P-waves, or compression waves, are waves that carry their energy along an expanding spherical wave front. The particle motion in these waves is longitudinal. S-waves, or shear waves, are also body waves that carry energy along an expanding spherical wave front. However, unlike P-waves, the particle motion is transverse, or side-to-side and perpendicular to the direction of propagation.

As vibration waves propagate from a source, the energy is spread over an ever-increasing area such that the energy level is reduced with the distance from the energy source. This geometric spreading loss is inversely proportional to the square of the distance. Wave energy is also reduced with distance as a result of material damping in the form of internal friction, soil layering, and special voids. The amount of attenuation provided by material damping varies with soil type and condition as well as the frequency of the wave.

**Table 2-1: Human Reaction to Typical Vibration Levels**

Vibration Level Peak Particle Velocity (in/sec)	Human Reaction	Effect on Buildings
0.006–0.019	Threshold of perception, possibility of intrusion	Vibrations unlikely to cause damage of any type
0.08	Vibrations readily perceptible	Recommended upper level of vibration to which ruins and ancient monuments should be subjected
0.10	Level at which continuous vibration begins to annoy people	Virtually no risk of “architectural” (i.e., not structural) damage to normal buildings
0.20	Vibrations annoying to people in buildings	Threshold at which there is a risk to “architectural” damage to normal dwelling – houses with plastered walls and ceilings
0.4–0.6	Vibrations considered unpleasant by people subjected to continuous vibrations and unacceptable to some people walking on bridges	Vibrations at a greater level than normally expected from traffic, but would cause “architectural” damage and possibly minor structural damage
Source: Caltrans, Division of Environmental Analysis, <i>Transportation Related Earthborne Vibration, Caltrans Experiences</i> , Technical Advisory, Vibration, TAV-02-01-R9601, 2002 (Caltrans, 2002).		

### **3.0 SIGNIFICANCE THRESHOLDS AND STANDARDS**

#### **3.1 Operational Standards**

The Property Line Noise Limits listed in Table 9 of the County’s General Plan Noise Element (County of Imperial General Plan, 2015) and the County’s Ordinance, Title 9, Division 7 (Noise Abatement and Control) Section 90702.00 Subsection A provides acceptable Sound level limits based on the property zoning. The applicable property line sound level limits are provided in Table 3-1 below and shall apply to noise generation from one property to an adjacent property. The standards imply the existence of a sensitive receptor on the adjacent, or receiving, property. In the absence of a sensitive receptor, an exception or variance to the standards may be appropriate. These standards do not apply to construction noise.

**Table 3-1: Property Line Noise Level Limits**

<b>Zone</b>	<b>Time</b>	<b>Applicable Limit One-hour Average Sound Level (Decibels)</b>
Residential Zones	7 a.m. to 10 p.m.	50
	10 p.m. to 7 a.m.	45
Multi-residential Zones	7 a.m. to 10 p.m.	55
	10 p.m. to 7 a.m.	50
Commercial Zones	7 a.m. to 10 p.m.	60
	10 p.m. to 7 a.m.	55
Light Industrial/Industrial Park Zones	Anytime	70
General Industrial Zones	Anytime	75
<p>When the noise-generating property and the receiving property have different uses, the more restrictive standard shall apply. When the ambient noise level is equal to or exceeds the Property Line noise standard, the increase of the existing or proposed noise shall not exceed 3 dB <math>L_{eq}</math>.</p> <p>The sound level limit between two zoning districts (different land uses) shall be measured at the property line between the properties.</p> <p>Fixed-location public utility distribution or transmission facilities located on or adjacent to a property line shall be subject to the noise level limits of subsection A of this section, measured at or beyond six feet from the boundary of the easement upon which the equipment is located.</p> <p>This section does not apply to noise generated by helicopters at heliports or helistops authorized by a conditional use permit.</p> <p>This section does not apply to noise generated by standard agricultural field operating practices such as planting and harvesting of crops. The County of Imperial has a Right to Farm Ordinance (1031) which serves as recognition to agricultural practices to new development. Agricultural/industrial operations shall comply with the noise levels prescribed under the general industrial zones.</p>		

Source: County of Imperial Ordinance, Title 9, Division 7 (Noise Abatement and Control)

These standards are intended to be enforced through the County's code enforcement program on the basis of complaints received from persons impacted by excessive noise. It must be acknowledged that a noise nuisance may occur even though an objective measurement with a sound level meter is not available. In such cases, the County may act to restrict disturbing, excessive, or offensive noise which causes discomfort or annoyance to reasonable persons of normal sensitivity residing in an area.

### 3.2 Construction Noise Standards

Based on the County of Imperial's Noise Element of the General Plan, construction noise from a single piece of equipment or a combination of equipment, shall not exceed 75 dB  $L_{eq}$ , when averaged over an eight (8) hour period, and measured at the nearest sensitive receptor. This standard assumes a construction period, relative to an individual sensitive receptor of days or weeks. In cases of extended length construction times, the standard may be tightened so as not to exceed 75 dB  $L_{eq}$  when averaged over a one (1) hour period.

Construction equipment operation shall be limited to the hours of 7 a.m. to 7 p.m., Monday through Friday, and 9 a.m. to 5 p.m. Saturday. No commercial construction operations are permitted on Sunday or holidays. In cases of a person constructing or modifying a residence for himself/herself, and if the work is not being performed as a business, construction equipment operations may be performed on Sundays and holidays between the hours of 9 a.m. and 5 p.m. Such non-commercial construction activities may be further restricted where disturbing, excessive, or offensive noise causes discomfort or annoyance to reasonable persons of normal sensitivity residing in an area.

### 3.3 Significant Increase of Ambient Noise Levels

The increase of noise levels generally results in an adverse impact to the noise environment. The Noise/Land Use Compatibility Guidelines are not intended to allow the increase of ambient noise levels up to the maximum without consideration of feasible noise reduction measures. The following guidelines are established by the County of Imperial for the evaluation of significant noise impact.

- a. If the future noise level after the Project is completed will be within the "normally acceptable" noise levels shown in the Noise/Land Use Compatibility Guidelines but will result in an increase of 5 dB CNEL or greater, the Project will have a potentially significant noise impact and mitigation measures must be considered.
- b. If the future noise level after the Project is completed will be greater than the "normally acceptable" noise levels shown in the Noise/Land Use Compatibility Guidelines, a noise increase of 3 dB CNEL or greater shall be considered a potentially significant noise impact and mitigation measures must be considered.



### 3.4 Vibration Standards

The County has not yet adopted vibration criteria. The United States Department of Transportation Federal Transit Administration (FTA) provides criteria for acceptable levels of groundborne vibration for various types of special buildings that are sensitive to vibration. For purposes of identifying potential project-related vibration impacts, the FTA criteria will be used. The human reaction to various levels of vibration is highly subjective. The upper end of the range shown for the threshold of perception, or roughly 65 VdB, may be considered annoying by some people. Vibration below 65 VdB may also cause secondary audible effects, such as a slight rattling of doors, suspended ceilings/fixtures, windows, and dishes, any of which may result in additional annoyance. Table 3-2 on the following page shows the FTA groundborne vibration and noise impact criteria for human annoyance.

In addition to the vibration annoyance standards presented above, the FTA also applies the following standards for construction vibration damage. Table 3-3 on the following page, structural damage is possible for typical residential construction when the peak particle velocity (PPV) exceeds 0.2 inch per second (in/sec). This criterion is the threshold at which there is a risk of damage to normal dwellings.

**Table 3-2: Vibration and Noise Impact Criteria (Human Annoyance)**

	Groundborne Vibration Impact Levels (VdB re 1 microinch/second)			Groundborne Noise Impact Levels (dB re 20 micropascals)		
	Frequent Events <sup>1</sup>	Occasional Events <sup>2</sup>	Infrequent Events <sup>3</sup>	Frequent Events <sup>1</sup>	Occasional Events <sup>2</sup>	Infrequent Events <sup>3</sup>
<b>Category 1:</b> Buildings where low ambient vibration is essential for interior operations.	65 VdB <sup>4</sup>	65 VdB <sup>4</sup>	65 VdB <sup>4</sup>	N/A <sup>4</sup>	N/A <sup>4</sup>	N/A <sup>4</sup>
<b>Category 2:</b> Residences and buildings where people normally sleep.	72 VdB	75 VdB	80 VdB	35 dBA	38 dBA	43 dBA
<b>Category 3:</b> Institutional land uses with primarily daytime use.	75 VdB	78 VdB	83 VdB	40 dBA	43 dBA	48 dBA
Source: United States Department of Transportation Federal Transit Administration (FTA), <i>Transit Noise and Vibration Impact Assessment Manual</i> , September 2018. <sup>1</sup> "Frequent Events" are defined as more than 70 vibration events per day. Most rapid transit projects fall into this category. <sup>2</sup> "Occasional Events" are defined as between 30 and 70 vibration events of the same source per day. Most commuter truck lines have this many operations. <sup>3</sup> "Infrequent Events" are defined as fewer than 30 vibration events of the same kind per day. This category includes most commuter rail branch lines <sup>4</sup> This criterion limit is based on levels that are acceptable for most moderately sensitive equipment such as optical microscopes. Vibration-sensitive manufacturing or research will require detailed evaluation to define the acceptable vibration levels. Ensuring lower vibration levels in a building often requires special design of the HVAC systems and stiffened floors. <sup>5</sup> Vibration-sensitive equipment is not sensitive to groundborne noise.						

**Table 3-3: Vibration Impact Criteria (Structural Damage)**

Building Category	PPV (in/sec)	VdB
I. Reinforced-concrete, steel, or timber (no plaster)	0.5	102
II. Engineered concrete and masonry (no plaster)	0.3	98
III. Non-engineered timber and masonry buildings	0.2	94
IV. Buildings extremely susceptible to vibration damage	0.12	90

Source: (FTA, 2018)  
Notes: RMS velocity calculated from vibration level (VdB) using the reference of one microinch/second.

## **4.0 ENVIRONMENTAL SETTINGS & EXISTING CONDITIONS**

### **4.1 Settings & Locations**

The proposed project is located within the unincorporated area of the Imperial County in southeastern California. Imperial County encompasses the southern half of the Salton Sea Air Basin (SSAB). The proposed project is situated about 1.25 miles north of the City of Imperial, California. The Project area is zoned Mesquite Lake Specific Plan, including ML GS (Mesquite Lake Government / Special Public), ML I-2 (Mesquite Lake Medium Industrial) and ML I-3 (Mesquite Lake Heavy Industrial), with a Renewable Energy Overlay Zone (Figure 2, Zoning Map). The General Plan Land Use designation for the entire Project is Mesquite Lake Specific Plan.

The Project site contains existing agricultural operations, including approximately 120 acres of recently harvested wheat that is planted and harvested as a rotation crop between other crops as well as approximately 84 acres that has been periodically farmed and is currently growing sugar beets and Sudan grass. The Project has an existing mainline switch on the Union Pacific Railroad and approximately 0.5 mile of on-site track. The Project site has vacant areas that have previously been farmed and the existing Memory Gardens Cemetery. Over the last 10 years, the Project site has consumed approximately 630 acre-feet per year (AFY) of water for agricultural purposes.

### **4.2 Existing Noise Conditions**

Mesquite Lake Specific Plan is located north, east, and south of the Project site, with agricultural land uses and equipment dealerships and other businesses located west of the Project site. North of the site is vacant, disturbed land, followed by a sugar manufacturing facility. East of the site is the UPRR, followed by agricultural fields. South of the site are agricultural fields as well as a property with a CUP for the development of a fertilizer terminal. A mix of agricultural fields and manufacturing uses, including Bakersfield Pipe Supply, RDO Farm Equipment, Empire Construction Machine Rental, and Rain for Rent, are located west of the Project site. The nearest single-family home is located approximately 0.25 mile east of the Project site.

### **4.3 Noise Measuring Methodology and Procedures**

To determine the existing noise environment and to assess potential noise impacts, measurements were taken at three locations on the project having a direct line of site to the adjacent roadways having a relatively flat terrain and no obstruction from trees or rock outcroppings. The noise measurements were recorded on January 10, 2023 by Ldn Consulting between approximately 11:00 a.m. and 2:30 p.m.

Noise measurements were taken using Larson-Davis Spark Model 706 Type 2 precision sound level meters, programmed, in "slow" mode, to record noise levels in "A" weighted form. The sound level meter and microphone were mounted on a tripod, five feet above the ground and equipped with a windscreen during all measurements. The sound level meter was calibrated before and after the monitoring using a Larson-Davis calibrator, Model CAL 200.

The noise measurement locations were determined based on site access and noise impact potential to the proposed sensitive uses. Monitoring location 1 (M1) was located along the western property line of the site along Imperial Avenue (SR-86), Monitoring location 2 (M2) was located along the southern property line of the site approximately 1,200-feet from SR-86, and Monitoring location 3 (M3) was located along the eastern property line of the site along the Union Pacific Railroad. The noise monitoring locations are provided graphically in Figure 1-C on the following page.

The results of the noise level measurements are presented in Table 4-1. The noise measurements were monitored for a time period of approximately 3 hours at each location. The ambient Leq noise levels measured in the area of the project during the afternoon hour were found to be roughly 70-72 dBA adjacent to the roadways. The existing noise levels in the project area consisted primarily of traffic along the roadways.

**Table 4-1: Existing Noise Levels**

Location	Time	One Hour Noise Levels (dBA)					
		Leq	Lmin	Lmax	L10	L50	L90
M1	11:18 a.m. – 2:16 p.m.	73.1	45.4	83.3	77.0	69.5	56.5
M2	11:18 a.m. – 2:16 p.m.	49.5	36.5	77.4	47.5	43.0	40.0
M3	11:18 a.m. – 2:16 p.m.	46.9	35.4	73.9	45.0	39.5	37.5

Source: Ldn Consulting, Inc. January 10, 2023

**Figure 4-A: Noise Measurement Locations**





#### 4.4 Receiver Locations

To assess the potential for long-term operational and short-term construction noise impacts, the following sensitive receiver locations, as identified below, were identified as representative locations for analysis. Sensitive receivers are generally defined as locations where people reside or where the presence of unwanted sound could otherwise adversely affect the use of the land. Noise-sensitive land uses are generally considered to include schools, hospitals, single-family dwellings, mobile home parks, churches, libraries, and recreation areas. Moderately noise-sensitive land uses typically include multi-family dwellings, hotels, motels, dormitories, out-patient clinics, cemeteries, golf courses, country clubs, athletic/tennis clubs, and equestrian clubs. Land uses that are considered relatively insensitive to noise include business, commercial, and professional developments. Land uses that are typically not affected by noise include: industrial, manufacturing, utilities, agriculture, undeveloped land, parking lots, warehousing, liquid and solid waste facilities, salvage yards, and transit terminals.

Receiver locations are located in outdoor living areas (e.g., backyards) at 10 feet from any existing or proposed barriers or at the building façade, whichever is closer to the Project site, based on FHWA guidance, and consistent with additional guidance provided by Caltrans and the FTA, as previously described in Section 3. Sensitive receiver locations in the Project study area include residential uses as described below. Other sensitive land uses in the Project study area that are located at greater distances than those identified in this noise study will experience lower noise levels than those presented in this report due to the additional attenuation from distance and the shielding of intervening structures. Distance is measured in a straight line from the project boundary to each receiver location.

The County of Imperial does not consider the surrounding agricultural and industrial land uses as sensitive uses. However, an existing residence is located to the east on land that is designated as industrial. The property is located approximately 0.25-miles to the east as shown in Figure 4-A above. Therefore, for the purpose of this study, the residence is considered a sensitive land use from the construction and operational activities.

## **5.0 CONSTRUCTION NOISE**

### 5.1 County of Imperial Construction Standards

Construction noise, from a single piece of equipment or a combination of equipment, shall not exceed 75 dB  $L_{eq}$ , when averaged over an eight (8) hour period, and measured at the nearest sensitive receptor. This standard assumes a construction period, relative to an individual sensitive receptor of days or weeks. In cases of extended length construction times, the standard may be tightened so as not to exceed 75 dB  $L_{eq}$  when averaged over a one (1) hour period. Construction equipment operation shall be limited to the hours of 7 a.m. to 7 p.m., Monday through Friday, and 9 a.m. to 5 p.m. Saturday. No commercial construction operations are permitted on Sunday or holidays.

### 5.2 Potential Project Construction Noise Impacts

Noise levels resulting from proposed construction activities were obtained from reports prepared by the FTA and the Federal Highway Administration (FHWA), satellite imagery from the site, and field data from files. Construction of the Project is expected to begin in approximately 2024 and would continue for an estimated 18 months if the site is built-out under a single construction effort. Site preparation is anticipated to take approximately 2 months, grading to take approximately 2 months, and vertical construction to occur over approximately 14 months. The Project is expected to employ approximately 400 construction workers over the course of build-out, with as many as 200 workers on-site daily during construction once structures and buildings go vertical. The Project is expected to use approximately 1,000 AFY of water during construction. Project build-out is expected to occur in approximately 2026. Construction activities of the Proposed Project will be scheduled in compliance with the Mesquite Lake Specific Plan and County's Municipal Code Title 9 for the provisions of operating and permitting the use of tools and equipment during construction, drilling, repair, or alterations. Project construction may occur incrementally overtime as a function of the need for incremental access to rail and other site infrastructure, and accordingly building permits may be issued incrementally over time.

Site preparation will include clearing and grubbing. The land development includes grading the site to create a rough graded street, native soil preparatory work for track facilities, and pads for new construction. The site preparation will include an estimated 150,000 cubic yards of cut and 150,000 cubic yards of fill; soil will be balanced on site. Other material imports would include an import of approximately 140,000 cubic yards of granular select fill for use underneath concrete building pads, an import of approximately 225,000 tons of ballast and 90,000 tons of sub-ballast for the three (3) loop tracks (approximately 22,000 track feet in total), ladder track (approximately 25,000 track feet in total and rail spur (approximately 2,000 track feet in total), and 28,000 tons of road base for the Industrial Street roadway, which will be surface finished with asphalt concrete. Other on-site flatwork will be finished with asphalt concrete and Portland cement concrete, including building and structural

pads, which will be comprised of rebar and Portland cement concrete. A concrete and rebar bridge/over-pass or a culvert/under-pass may ultimately be built in order to take trucks to and from the inside of the loop tracks. Prior to the full loop tracks being constructed, a private roadway will be constructed for access to the central part of the Project.

In addition to contractor vehicles, heavy equipment will be used on site and will include, but is not limited to, excavators, backhoes, trenchers, cranes, bulldozers, graders, compactors, track laying equipment, pavers, and dump trucks. All equipment will be staged within the Project site. Access to the UPRR Right-of-Way (ROW) will be needed for construction.

Construction noise is usually made up of intermittent noise peaks and continuous lower levels of noise from equipment cycling through use. Noise levels associated with individual pieces of equipment can generally range between 70 and 90 dBA (FTA, 2018). Based on the proposed construction equipment list and industry-wide noise reference levels, the estimated maximum composite construction noise level for the Project is 93 dBA at a distance of 50 feet from the building, mechanical, and electrical work sites (FHA, 2006). Additionally, noise from trucks, commuter vehicles, and other on-road equipment, which would mainly be along streets and access roads, would produce peak levels of approximately 88 dBA at 50 feet from the source (FTA, 2018).

During a typical day, equipment would not be operated continuously at peak levels. While the average noise levels on-site could exceed the 75 dBA Leq construction noise standard established by County of Imperial for General Industrial Zones, noise would attenuate to levels below the threshold with increasing distance until it reaches the nearest sensitive receptors. To abate noise pollution, the applicant would install mufflers on engine-driven equipment during both construction and development operations. Additionally, the applicant would implement an exhaust emissions control program during Project construction, which would include, but not limited to, engine maintenance, and procedures to minimize emissions that would assist in reducing noise. Generally, exhaust emission control programs include the minimization of unnecessary vehicle and equipment idling time either by shutting equipment off when not in use or reducing idling time. Therefore, it is anticipated that construction noise would be reduced from the estimated peak levels.

Most of the project construction would be located within the western half of the project site approximately 0.5-miles or more away from the nearest residential noise receptor to the east. However, portions of the site construction would be as close as 0.25-miles. Therefore, to be conservative, construction noise levels were calculated at 0.25-miles from the nearest noise sensitive residential land use. As shown on Table 5-1, construction noise levels would attenuate from 93 dBA at 50 feet from the source to 65 dBA at the closest residential receptor due to geometric spreading of sound energy. Therefore, all calculated noise levels would fall within the normally acceptable range of the guidance set forth in the County of Imperial General Plan Noise Element.

**Table 5-1: Construction Noise Levels**

Sensitive Receptor	Source Level @ 50-Foot (dBA)	Approximate Distance to Residential Receptor	Noise Reduction Due to Distance (dBA)	Resultant Noise Level at Sensitive Receptor (dBA)
Residence	93	0.25-miles east	-28	65
County of Imperial Threshold				75
<b>IMPACT?</b>				<b>NO</b>

### 5.3 Construction Vibration

The County has not yet adopted vibration criteria. The United States Department of Transportation Federal Transit Administration (FTA) provides criteria for acceptable levels of groundborne vibration for various types of special buildings that are sensitive to vibration. For purposes of identifying potential project-related vibration impacts, the FTA criteria will be used.

The FTA has determined vibration levels that would cause annoyance to a substantial number of people and potential damage to building structures. The FTA criterion for vibration induced structural damage is 0.20 in/sec for the peak particle velocity (PPV). Project construction activities would result in PPV levels below the FTA’s criteria for vibration induced structural damage. The FTA criterion for infrequent vibration induced annoyance is 80 Vibration Velocity (VdB) for residential uses. Construction activities would generate levels of vibration that would not exceed the FTA criteria for nuisance for nearby residential uses.

There are no vibration-sensitive uses located adjacent to the proposed construction. The nearest residential use is located over 0.25-miles from any construction activities. Table 5-2 lists the average vibration levels that could be experienced at adjacent land uses from the temporary construction activities at a distance of 100-feet. Project construction activities are located a minimum of 0.25-miles away, therefore, would not result in vibration induced structural damage or vibration induced annoyance to adjacent land uses. Therefore, vibration impacts would be less than significant.

**Table 5-2: Vibration Levels from Construction Activities**

Equipment	Approximate Velocity Level at 25 Feet (VdB)	Approximate RMS Velocity at 25 Feet (in/sec)	Approximate Velocity Level at 100 Feet (VdB)	Approximate RMS Velocity at 100 Feet (in/sec)
Small bulldozer	58	0.003	40.0	0.0004
Jackhammer	79	0.035	61.0	0.0044
Loaded trucks	86	0.076	68.0	0.0095
Large bulldozer	87	0.089	69.0	0.0111
FTA Criteria			80	0.2
<b>Significant Impact?</b>			<b>No</b>	<b>No</b>
<sup>1</sup> PPV at Distance D = PPVref x (25/D) <sup>1.5</sup>				

**5.4 Construction Conclusions**

As can be seen in Table 5-1, at a distance of 0.25-miles from the residential property, the point source noise attenuation from construction activities is reduced 28 dBA to a level of approximately 65 dBA. This would result in an anticipated worst case eight-hour average combined noise level well below 75 dBA at the property line. Given this, the noise levels will comply with the County of Imperial’s 75 dBA standard at the nearest residential property lines and no impacts are anticipated.

There are no vibration-sensitive uses located adjacent to the proposed construction. The nearest residential use is located over 0.25-miles from any construction activities. Therefore, project construction activities would not result in vibration induced structural damage or vibration induced annoyance to adjacent land uses. Therefore, vibration impacts would be less than significant.



## **6.0 OPERATIONAL NOISE**

### 6.1 Guidelines for the Determination of Significance

The County Ordinance, Title 9, Division 7 (Noise Abatement and Control) states it is unlawful for any person to make or cause any noise to the extent that the one-hour average sound level, at any point on or beyond the boundaries of their property exceeds the applicable limits provided above in Table 3-1. Mesquite Lake Specific Plan is located north, east, and south of the Project site, with agricultural land uses and equipment dealerships and other businesses located west of the Project site. North of the site is vacant, disturbed land, followed by a sugar manufacturing facility. East of the site is the UPRR, followed by agricultural fields. South of the site are agricultural fields as well as a property with a CUP for the development of a fertilizer terminal. The nearest residence is located 0.25-miles east.

Section 90702.00 of the Noise Ordinance sets a sound level limit of 50 dBA Leq for daytime hours of 7 a.m. to 10 p.m. and 45 dBA Leq during the noise sensitive nighttime hours of 10 p.m. to 7 a.m. for residential noise sensitive land uses. The proposed Project components are expected to operate during both daytime and nighttime hours and therefore the most restrictive and conservative approach is to apply the 45 dBA Leq nighttime standard at the property lines.

### 6.2 Potential Operational Noise Impacts

This section examines the potential stationary noise source impacts associated with the operation of the proposed Project. Primary noise sources at the railroad facility would include the transloading of commodities; water treatment, storage, and distribution; a grain elevator; the hay and grain export and container depot; and the fuel blending and transloading area and fueling station.

The locations of the railroad facility and potential operations are shown in Figure 6-A. The most sensitive property line to the operational noise sources, by distance and orientation, is the existing single-family home located approximately 0.25 mile east of the Project site. All other property lines are located further away, allowing a less restrictive noise standard or a higher noise level.

### 6.3 Reference Noise Levels

This section provides a detailed description of the reference noise level measurement results. It is important to note that the following projected noise levels assume the worst-case noise environment with all occurring at the same time. In reality, these noise levels will vary throughout the day. The proposed Project components are expected to operate during both daytime and nighttime hours and therefore must meet the most restrictive nighttime standard of 45 dBA Leq at the residence.

**Figure 6-A: Noise Source Locations**

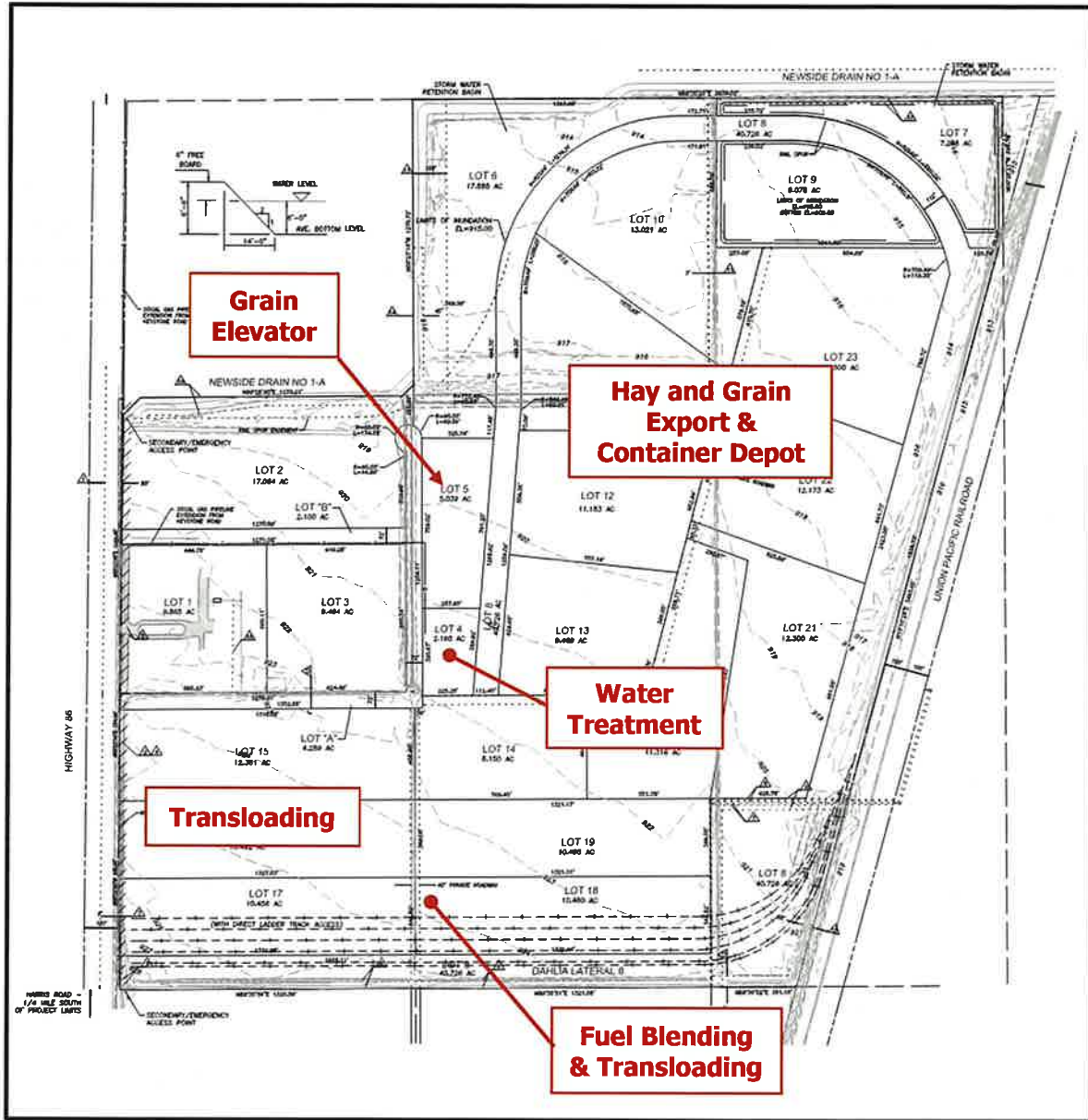

Source: (The Holt Group, Inc., 2023)

## Water Treatment

The Project will include a water treatment, storage and distribution system that will satisfy potable water and fire water requirements. The system will receive water from the IID Dahlia Lateral 8 canal located along the southerly boundary of the Project. The treatment, storage and pump elements of the system will be located on an approximately 2-acre parcel. The distribution element of the system will be a looped pressurized water line that will provide access to water for all Project parcels. The water treatment, storage and distribution system will likely be developed in phases with an initial phase having a storage capacity of approximately 180,000 gallons and a built-out storage capacity of up to 1.5 million gallons. A 1.5-million-gallon tank would be approximately 50 feet tall and approximately 100 feet in diameter. During initial operations and prior to the need for a public water system, the applicant may truck-in purified/potable water.

Water treatment facilities typically include a pump system, transformer, and backup generator. Based on a similar use, the project may require a 100 HP motor which is typically housed within an enclosed pump building, up to a 100 kVA transformer, and a 150-kilowatt (kW) generator (LDN Consulting, Inc., 2022). The pump would generate a noise level of 45 dBA at a distance of 15 feet from the access hatch. The proposed transformer has an unshielded noise rating of less than 51 dBA at 5 feet (National Electric Manufacturers Association (NEMA)). Tested outdoor sound levels were provided by the manufacturer/supplier of a typical generator. The noise ratings provided, indicate the generator will produce reduced noise levels of 75 dBA during weekly engine exercise and during normal operation when measured at a distance of 23-feet in all directions with the manufacturer's sound enclosure. Due to the noise level of the backup generator, the pump system and transformer would not cumulatively add to the overall noise levels. Therefore, the primary source of noise from the water treatment facility would be the backup generator.

As can be seen in Table 6-1, the noise levels would be below the 45 dBA Leq thresholds at the nearest single-family property line located an average of 3,300 feet to the east of the water treatment facility. Therefore, the water treatment facility activities are in compliance with the County's noise standards and no mitigation or impacts are anticipated.

**Table 6-1: Water Treatment Noise Levels**

Source	Noise Level @ 23 Feet (dBA)	Quantity <sup>1</sup>	Cumulative Noise Level (dBA)	Average Distance to Nearest Property Line (Feet)	Noise Reduction due to distance (dBA)	Resultant Noise Level @ Property Line (dBA)
Generator	75	1	75.0	3,300	-43.1	31.9

<sup>1</sup> Source: Project Site Plan

### Grain Elevator System

The grain elevator is primarily for receiving corn and similar grain products via rail and distributing them to cattle feeding yards. The grain elevator system will be up to 180 feet tall and be comprised of up to four (4) large tanks/bins initially, expanding to a total of eight (8) large tanks/bins, and several ancillary mechanical components and will be built on a parcel that is approximately 10 acres.

The primary source of noise from the grain elevator system is the various conveyor systems required to load the grain into the 180-foot-tall elevators. Since the Project will expand to have a total of eight large tanks/bins, it was assumed that eight conveyor systems will be required to fill the bins simultaneously. Empirical data provided by the Environmental Protection Agency (EPA 1971); a single conveyor system would produce noise levels up to 71 dBA at 50-feet.

As can be seen in Table 6-2, assuming a worst-case of eight conveyor systems running simultaneously, the noise levels would be below the 45 dBA Leq thresholds at the nearest single-family property line located an average of 3,500 feet to the east of the grain elevator system. Therefore, the grain elevator system activities are in compliance with the County's noise standards and no mitigation or impacts are anticipated.

**Table 6-2: Grain Elevator System Noise Levels**

Source	Noise Level @ 50 Feet (dBA)	Quantity <sup>1</sup>	Cumulative Noise Level (dBA)	Average Distance to Nearest Property Line (Feet)	Noise Reduction due to distance (dBA)	Resultant Noise Level @ Property Line (dBA)
Conveyors	71	8	80.0	3,500	-36.9	43.1

<sup>1</sup>Source: Project Site Plan

### Fueling Station Including CNG

The fueling station would be used to fuel vehicles and trucks on site. The approximate amount of fuel sold from the fueling station on an annual basis is as follows: (a) Unleaded fuel: 2,500,000 gallons, (b) Diesel: 4,750,000 gallons and (c) CNG: 5,500,000 gallons. Electric vehicles and hydrogen fuel cell vehicles will also be able to fill up at the fueling station. There would also be truck scales on-site at the fueling station as well as an approximately 30,000 square foot travel center area. The SoCal Gas pipeline that is being extended to the Project site approximately 1.3 miles along State Route 86 from Keystone Road would supply gas to the CNG fueling component of the fueling station.

The primary source of noise from the fueling station is the fuel compressors. To be conservative and to account for future growth, four trucks were assumed to be fueling simultaneously, requiring four separate fuel compressors to be operating at the same time. Based on test data received by the manufacturer of a typical compressor used in fueling stations, noise levels from the compressor are 79 dBA at a distance of ten feet. It should be noted the compressor will not be operating continuously but only when a truck is fueling.

As can be seen in Table 6-3, assuming a worst-case of four trucks fueling simultaneously, the noise levels would be below the 45 dBA Leq thresholds at the nearest single-family property line located an average of 3,400 feet to the east of the fueling station. Therefore, the fueling station activities are in compliance with the County’s noise standards and no mitigation or impacts are anticipated.

**Table 6-3: Fueling Station Noise Levels**

Source	Noise Level @ 10 Feet (dBA)	Quantity <sup>1</sup>	Cumulative Noise Level (dBA)	Average Distance to Nearest Property Line (Feet)	Noise Reduction due to distance (dBA)	Resultant Noise Level @ Property Line (dBA)
Compressors	79	4	85.0	3,400	-50.6	34.4

<sup>1</sup>Source: Project Site Plan

Transloading

The primary source of noise from the transloading operations will be from trucks loading and unloading to and from the loop tracks that tie into the adjacent Union Pacific Railroad ROW. Transloading of goods will be associated with operations at the grain elevators, fuel blending, hay and grain export, produce/food export, and general commodities. This analysis uses trip generation info from the Linscott Law & Greenspan traffic study for the Project dated April 26, 2023.

*Grain Elevator System*

The grain elevator would receive approximately 450,000 tons (40-unit trains) of corn annually and approximately 150,000 tons (20 trains) of Dried Distillers Grain (DDG) annually via the Project tracks. This portion of the Project would employ approximately eight people split between approximately two shifts per day (5am to 1pm and 11am to 7pm). UPRR unit trains are currently 110 rail cars in length; however, the rail industry is moving to expand unit rail length to approximately 126 cars. The DDG would come into the site via approximately 75-car trains and may come in via the loop tracks or via the ladder tracks south of and adjacent to, the loop tracks.



Approximately 60 grain elevator trucks with an ADT of 120 would be required per day to take feed to customers. Grain such as corn and DDG may also be brought to the site by Union Pacific in smaller blocks such as 30 to 50 rail cars.

#### *Fuel Blending and Transloading Area and Fueling Station*

Fuel products will be railed in on-site and transloaded/blended for outbound movement via truck to off-site locations, including Mexico. The approximate amount of fuel that will be annually transloaded/blended at the Project are as follows: (a) Biodiesel fuel: 130,000,000 gallons, (b) Regular diesel: 50,000,000 gallons and (c) Liquefied Petroleum Gas (LPG)/Natural Gas Liquids (NGL): 90,000,000 gallons. The fuel blending / transloading function would employ approximately four people split between approximately two shifts per day (5am to 1pm and 11am to 7pm). Approximately 50 fuel trucks would be required per day with an ADT of 100 to take blended / transloaded fuel from on-site to customers, and the facility would have the ability to store up to 2,000,000 gallons of fuel on-site via up to four (4) above ground tanks.

#### *Hay and Grain Export and Container Depot*

The area in the middle of the loop tracks will be used primarily as a shipping container depot and for exporting hay and grain products via UPRR. The hay and grain export and container depot would employ approximately 12 people split between approximately two shifts per day (5am to 1pm and 11am to 7pm). Hay and grain trucks each carrying approximately twenty-five (25) containerized tons would be required per day to bring inbound hay and grain to the facility where it would be railed to the Ports of Los Angeles and Long Beach. The hay and grain would be grown within the irrigated area of Imperial County and brought to the site intermittently during hours of operation. Ocean shipping containers would first arrive on-site via UPRR from the Ports of Los Angeles and Long Beach full of miscellaneous products from overseas that are destined for distribution throughout the United States and Mexico. The miscellaneous products from overseas would be sorted and placed into domestic shipping containers for out-bound shipment via UPRR to major metropolitan hubs throughout the United States. In addition, full containers of miscellaneous products from the Ports of Los Angeles and Long Beach would arrive on-site via UPRR and be transloaded to truck for delivery to Mexico. The ocean shipping containers stuffed with approximately 1,025,000 tons (170-unit trains) of hay and grain annually that would be exported from the site via UPRR and returned to the ports of Los Angeles and Long Beach for shipment overseas to pre-dominantly Asian and Middle Eastern markets. This area will also intermittently receive empty contains from coastal and inland ports for storage and shipping reuse and may be used for the rail served transloading and warehousing of general commodities.

### *Produce / Food Export*

The produce export function would employ approximately six people split between approximately two shifts per day (5am to 1pm and 11am to 7pm). Produce would be trucked in on-site from locally grown sources, maybe temperature treated (cold storage prior to customer shipment) and would be exported via UPRR to domestic and international customers. Such produces would likely consist of the following: (a) Broccoli: 45,000 tons, (b) Cabbage: 26,000 tons, (c) Carrot: 128,000 tons, (d) Cauliflower: 77,000 tons, (e) Cantaloupe: 120,000 tons, (f) Citrus: 2,000 tons, (g) Onion: 110,000 tons, and (f) beef: 42,000 tons.

Produce and food grown outside of the County would be railed into the County via UPRR, sorted, stored, and shipped to Mexico via truck. Such produce and food would likely consist of the following: (a) Apples, Onions and Potatoes: 35,000 tons, (b) Dry food goods : 20,000 tons, (c) Palletized food products packaged in cans : 25,000 tons, (d) Frozen pork : 145,000 tons, (e) Frozen poultry : 160,000 tons, and (f) Processed food grain corn in super sacks : 20,000 tons.

### *General Commodities*

The remaining portion of the Project area that is not occupied by the rail system and above-mentioned Project elements will be used for the transloading, storage and shipment of additional commodities. The approximate types and amounts of general commodities being transloaded/warehoused on an annual basis on site is as follows: (a) Lumber: 150,000 tons, (b) Fertilizers: 30,000 tons, (c) Plastics: 60,000 tons, (d) Rolled Steel: 85,000 tons, (e) 35% Hydrochloric Acid: 60,000 tons, (f) 50% Caustic Soda: 40,000 tons, (g) 95% Sulfuric Acid: 25,000 tons and (h) Paper: 50,000 tons. Transloading/warehousing of general commodities would employ approximately 18 people split between approximately two shifts per day (5am to 1pm and 11am to 7pm).

The primary source of noise associated with the grain elevator system are the trucks loading and offloading grain between the grain elevators and the trains. Transloading of goods will be associated with operations at the grain elevators, fuel blending, hay and grain export, produce/food export, and general commodities. Trip generation volumes are provided by the Project traffic study prepared by Linscott Law & Greenspan dated April 26, 2023 and shown in Figure 6-B. Based on the proposed operations detailed above, the project will require 218 trucks a day to transload goods to and from the rail line. The facility will operate between 5:00 am to 7:00 pm. Therefore, it is expected that an average of 16 trucks would be transloading goods on site per hour.

**Figure 6-B: Project Trip Generation**

Number and Type of Trips	Daily Trips			AM Peak Hour (w/PCE)			PM Peak Hour (w/PCE) <sup>d</sup>		
	ADT <sup>a</sup>	PCE <sup>b</sup>	PCE Adjusted ADT	In	Out	Total	In	Out	Total
<b>Phase 1</b>									
20 Worker Vehicles <sup>c</sup>	42	1.0	42	4	0	4	0	4	4
48 Grain Elevator Trucks	96	2.0	192	7	7	14	7	7	14
24 Fuel trucks	48	2.0	96	3	3	6	3	3	6
8 Railed-in Products Export Trucks	16	2.0	32	1	1	2	1	1	2
20 Trucking Only Trucks	40	2.0	80	3	3	6	3	3	6
<b>Phase 1 Subtotal</b>	<b>242</b>	<b>-</b>	<b>442</b>	<b>18</b>	<b>14</b>	<b>32</b>	<b>14</b>	<b>18</b>	<b>32</b>
<b>Phase 2</b>									
31 Worker Vehicles <sup>c</sup>	65	1.0	65	7	0	7	0	7	7
5 Grain Elevator Trucks	10	2.0	20	1	1	2	1	1	2
9 Fuel trucks	18	2.0	36	1	1	2	1	1	2
33 Railed-in Products Export Trucks	66	2.0	132	5	5	10	5	5	10
71 Trucking Only Trucks	142	2.0	284	10	10	20	10	10	20
<b>Phase 2 Subtotal</b>	<b>301</b>	<b>-</b>	<b>537</b>	<b>24</b>	<b>17</b>	<b>41</b>	<b>17</b>	<b>24</b>	<b>41</b>
<b>Total Trips:</b>	<b>543</b>	<b>-</b>	<b>979</b>	<b>42</b>	<b>31</b>	<b>73</b>	<b>31</b>	<b>42</b>	<b>73</b>
<p><b>Footnotes:</b></p> <p>a. Average Daily Trips</p> <p>b. Passenger Car Equivalents. Based on the <i>Highway Capacity Manual</i>, a Passenger Car Equivalent (PCE) factor of 2.0 was applied to the Project's heavy-truck trips.</p> <p>c. A total of 56 on-site employees are expected each day at Project buildout. Based on data provided in the <i>Imperial County Transportation Commission Regional Active Transportation Plan</i>, February 2022, 9% of the on-site employees (5 people total) were assumed to carpool with other employees. A trip rate of 2.1 ADT per worker vehicle was assumed to account for the trips to and from the Project site as well as the occasional mid-workday errand. Based on the location of the site, the provision of on-site services, and the nature of the Project, mid-workday trips are expected to be very sporadic.</p> <p>d. Heavy-duty trucks are assumed to access the site consistently between the hours of 5AM and 7PM (approximately 16 heavy vehicles per hour for 14-hours at Project buildout).</p>									

In order to evaluate the potential noise impacts of the trucks, the analysis utilized reference noise level measurements taken at a Walmart Distribution Center in 2018. The measurements include truck drive-by noise, truck loading/unloading and truck engine noise. Regular trucks create a noise level of 67 dBA at 23 feet. It was assumed that 16 trucks could be loading and unloading simultaneously on site in any given hour. Although it is unlikely that all trucks would be operating at the same time, this is considered conservative.

A truck will take approximately 5 minutes to drive in the site and position itself into a parking or loading bay. Based on the fact that trucks are typically not allowed to idle for more than 5 minutes within the State of California, it is assumed that each trip would not exceed 5 minutes or 10 minutes per round trip. Noise levels drop 3 decibels each time the duration of the source is reduced in half. Therefore, hourly truck noise level over a 10 minute period would be reduced approximately 7.8 decibels to 59.2 dBA based on operational time. To predict the property line noise level, a reference noise level of 59.2 dBA at 23-feet was used to represent the truck operations.

As can be seen in Table 6-4, assuming all the trucks are operating for the full hour on site at the same time the noise levels would be below the 45 dBA Leq thresholds at the nearest single-family property line located an average of 2,800 feet to the east of the transloading areas. Therefore, the truck activities are in compliance with the County’s noise standards and no mitigation or impacts are anticipated.

**Table 6-4: Transloading Noise Levels**

Source	Noise Level @ 23 Feet (dBA)	Quantity <sup>1</sup>	Cumulative Noise Level (dBA)	Average Distance to Nearest Property Line (Feet)	Noise Reduction due to distance (dBA)	Resultant Noise Level @ Property Line (dBA)
Trucks	59.2	16	71.2	2,800	-41.7	29.5

<sup>1</sup> Source: Project Site Plan

#### 6.4 Cumulative Noise Levels

The noise levels for each of the sources were combined to determine the cumulative noise levels at the residential property line to the east. The projection includes the water treatment system, grain elevators, fueling blending and pump station, and various transloading operations operating at the same time. Although it is unlikely all the noise sources would be operating at the same time, this method is considered ultra conservative in determining impact potential. The cumulative noise level at the property line to the east is listed in Table 6-5 on the following page.

**Table 6-5: Property Line Noise Levels**

Source	Distance from Source to Measurement Location (Feet)	Measured Noise Level (dBA)	Quantity	Distance to Nearest Property Line (Feet)	Noise Reduction due to distance (dBA)	Resultant Noise Level @ Property Line (dBA)
Water Treatment	23	75.0	1	3,300	-43.1	31.9
Grain Elevators	50	71.0	8	3,500	-36.9	43.1
Fueling Station	10	79.0	4	3,400	-50.6	34.4
Transloading	23	59.2	16	2,800	-41.7	29.5
<b>Cumulative Noise Level @ Property Line (dBA)</b>						<b>44.1</b>
<b>County of Imperial Threshold</b>						<b>45</b>
<b>IMPACT?</b>						<b>NO</b>

The resultant cumulative noise level at the residential property line to the east is projected to be at or below 45 dBA Leq. Therefore, cumulatively the proposed project related operational noise levels comply with the County’s nighttime noise standards at the residences to the east. Implementation of the Green Valley Logistics Center Project would not result in a substantial increase in ambient noise levels at off-site noise-sensitive receptors or exceed the County of Imperial Property Line Noise Standards. Therefore, operational noise impacts would be less than significant.

**6.5 Conclusions**

Based on the empirical data and the distances to the property lines the unshielded noise levels from the proposed equipment were found to be below the County’s most restrictive nighttime property line standard of 45 dBA. No impacts are anticipated and no mitigation is required.



## **7.0 TRANSPORTATION NOISE**

### Project Related Offsite Transportation Noise

To determine if direct or cumulative off-site noise level increases associated with the development of the proposed project would create noise impacts, the traffic volumes for the existing conditions were compared with the traffic volume increase of existing plus the proposed project. According to the Project VMP Analysis (Linscott, Law & Greenspan Engineers, 2023), the Project is expected to generate 979 ADT.

Access to the Project will be via Imperial Avenue (SR-86) to the west. The existing average daily traffic (ADT) volumes on Imperial Avenue is several thousand ADT. Typically, it requires a project to double (or add 100%) the traffic volumes to have a direct impact of 3 dBA CNEL or be a major contributor to the cumulative traffic volumes. The project will add less than a 25% increase to Imperial Avenue volumes. Therefore, no direct or cumulative impacts are anticipated.

## **8.0 REFERENCES**

- Caltrans. (2002). *Transportation Related Earthborne Vibration, Caltrans Experiences*. Retrieved from <https://dot.ca.gov/-/media/dot-media/programs/environmental-analysis/documents/env/tcvgm-apr2020-a11y.pdf>
- County of Imperial General Plan. (2015). *Noise Element of the General Plan*.
- FHA. (2006). *Roadway Construction Noise Model User's Guide*. Federal Highway Administration. Retrieved from <https://dot.ca.gov/-/media/dot-media/programs/environmental-analysis/documents/env/tcvgm-apr2020-a11y.pdf>
- FTA. (2018). *Transit Noise and Vibration Impact Assessment Manual*.
- Google. (2023). Retrieved from [maps.google.com](https://maps.google.com)
- LDN Consulting, Inc. (2022). 11th and Vernon Booster Station Noise.
- Linscott, Law & Greenspan Engineers. (2023). *Green Valley Logistics Center VMT and LMA*.
- National Electric Manufacturers Association (NEMA). (n.d.). *Publication No. TR 1-1993*.
- The Holt Group, Inc. (2023). *Project Site Plan*.

TRANSPORTATION IMPACT ANALYSIS  
**GREEN VALLEY LOGISTICS CENTER**  
Imperial County, California  
July 14, 2023

LLG Ref. 3-22-3520

*Prepared by:*  
Amelia Giacalone  
Senior Transportation Planner  
&  
Zahira Chayeb  
Transportation Engineer I

*Under the Supervision of:*  
John Boarman, PE  
Principal

**Linscott, Law &  
Greenspan, Engineers**

4542 Ruffner Street  
Suite 100  
San Diego, CA 92111

858.300.8800 T

858.300.8810 F

[www.llgengineers.com](http://www.llgengineers.com)

EEC ORIGINAL PKG

## TABLE OF CONTENTS

SECTION	PAGE
<b>1.0 Project and Study Description</b> .....	<b>4</b>
1.1 Project Location and Vicinity Map.....	4
1.2 General Plan and Zoning Designation.....	4
1.3 Project Size and Description.....	4
1.4 Project Access.....	5
1.5 Proposed Project Opening Year and Analysis Scenarios.....	5
<b>2.0 Vehicle Miles Traveled Assessment</b> .....	<b>8</b>
2.1 Background.....	8
2.2 Methodology.....	8
2.2.1 Heavy Duty Vehicles.....	8
2.2.2 Employee Passenger Vehicles.....	8
2.3 Reduction in Vehicle Miles Traveled.....	9
<b>3.0 Local Mobility Analysis</b> .....	<b>10</b>
3.1 Analysis Approach and Methodology.....	10
3.1.1 Level of Service.....	10
3.1.2 Intersections.....	10
3.2 Substantial Effect Criteria.....	10
<b>4.0 Existing Conditions</b> .....	<b>12</b>
4.1 Study Area.....	12
4.2 Existing Transportation Conditions.....	12
4.3 Existing Traffic Volumes.....	13
4.4 Peak Hour Intersection Operations.....	13
<b>5.0 Project Traffic</b> .....	<b>17</b>
5.1 Trip Generation.....	17
5.2 Trip Distribution and Assignment.....	18
<b>6.0 Cumulative Traffic Volumes</b> .....	<b>25</b>
<b>7.0 Capacity Analysis</b> .....	<b>29</b>
7.1 Peak Hour Intersection Operations.....	29
7.1.1 Opening Year (Existing + Cumulative Projects) Without Project Conditions.....	29
7.1.2 Opening Year With Project Conditions.....	29
<b>8.0 Conclusions</b> .....	<b>31</b>
8.1 VMT Assessment.....	31
8.1.1 Heavy Vehicles.....	31

8.1.2 Employee Passenger Vehicles .....	31
8.2 Local Mobility Analysis .....	31

## APPENDICES

---

### APPENDIX

---

- A. Intersection Manual Count Sheets
- B. Intersection Analysis Worksheets – Existing
- C. Intersection Analysis Worksheets – Opening Year without Project
- D. Intersection Analysis Worksheets – Opening Year + Project
- E. Excerpt from the *Imperial County Transportation Commission Regional Active Transportation Plan*

## LIST OF FIGURES

SECTION—FIGURE #	FOLLOWING PAGE
Figure 1–1 Project Vicinity Map.....	6
Figure 1–2 Project Site Plan.....	7
Figure 4–1 Existing Conditions Diagram.....	15
Figure 4–2 Existing Traffic Volumes.....	16
Figure 5–1a Project Trip Distribution: Employee Trips .....	20
Figure 5–1b Project Trip Distribution: Truck Trips .....	21
Figure 5–2a Project Traffic Assignment: Employee Trips.....	22
Figure 5–2b Project Traffic Assignment: Truck Trips .....	23
Figure 5–3 Total Project Traffic Assignment.....	24
Figure 6–1 Cumulative Projects Traffic Volumes .....	26
Figure 6–2 Opening Year (Existing + Cumulative Projects) Traffic Volumes.....	27
Figure 6–3 Opening Year + Project Traffic Volumes .....	28



## LIST OF TABLES

<b>SECTION—TABLE #</b>	<b>PAGE</b>
Table 3-1 Traffic Impact Substantial Effect Criteria .....	11
Table 4-1 Existing Intersection Operations.....	14
Table 5-1 Project Trip Generation.....	19
Table 7-1 Opening Year Intersection Operations .....	30

TRANSPORTATION IMPACT ANALYSIS  
**GREEN VALLEY LOGISTICS CENTER**  
Imperial County, California  
July 14, 2023

## 1.0 PROJECT AND STUDY DESCRIPTION

Linscott, Law and Greenspan, Engineers (LLG) has prepared this Vehicle Miles Traveled (VMT) and Local Mobility Analysis (LMA) report to assess the impacts to the street system as a result of the Green Valley Logistics Center project (Project), located in Imperial County.

The traffic analysis presented in this report includes the following:

- Section 1.* Project and Study Description.
- Section 2.* Vehicle Miles Traveled Assessment
- Section 3.* Local Mobility Analysis
- Section 4.* Existing Conditions
- Section 5.* Project Traffic
- Section 6.* Cumulative Traffic Volumes
- Section 7.* Capacity Analysis
- Section 8.* Conclusions

### 1.1 Project Location and Vicinity Map

The approximately 285-acre site is located in the area north of Dahlia Lateral 8, West of the Union Pacific Rail Road, East of SR-86 and South of IID Newside Drain No. 1-A in the unincorporated County of Imperial.

*Figure 1-1* is the Vicinity Map depicting the Project location.

### 1.2 General Plan and Zoning Designation

The site located is in the Mesquite Lake Specific Plan. The Project includes the application for a zone change for a portion of the site to ML-I-3 (Mesquite Lake Heavy Industrial) and a Specific Plan Amendment to accompany the zone change. The Project also includes a Tentative Tract Map for the subdivision of real property and configuration of an on-site roadway. A General Plan amendment is not required.

### 1.3 Project Size and Description

The site includes up to three (3) proposed loop tracks that tie into the adjacent Union Pacific Railroad right-of-way, a ladder track, and an additional spur (“rail system”). The rail system will facilitate in-bound and out-bound trains with commodities as well as transloading to and from trucks. The site includes a grain elevator for receiving and distributing corn and similar feed products for consumption by cattle feeder yards and similar.

The Memory Gardens Cemetery is part of the subject property, but it will be fenced off from the balance of the Project area. The remainder of the Project area that is not occupied by the rail system, the grain elevator and the cemetery property will be used for the transloading and storage/warehousing of additional commodities, a shipping container depot, and fueling blending/transloading/storage. Development standards and hours of operation on-site will be consistent with those of the Mesquite Lake Specific Plan and in accordance with Imperial County Planning & Development Services. Also proposed is a fueling station including, but not limited to, Compressed Natural Gas (CNG).

#### **1.4 Project Access**

Access to the site will be provided via two driveways to SR 86. The north driveway will accommodate right-turn only egress and the south driveway will accommodate right-turn only ingress.

As a Project feature, the Project will require inbound and outbound heavy trucks to adhere to the following designated truck routes. The designated truck routes are intended to restrict heavy vehicles from turning across multiple lanes of oncoming traffic at unsignalized intersections on SR 111. The truck route requirements will be included as a Condition of Approval and will be enforced through on-site signage, off-site signage as appropriate, and in contracts with outside trucking agencies.

- When leaving the site, heavy trucks heading to the south / east via SR 111 will be required to make a right-turn out of the site onto SR 86, a right-turn from SR 86 to Keystone Road, a right-turn from Keystone Road to Dogwood Road, a left-turn from Dogwood Road onto Worthington Road, and a right-turn at the signalized intersection of Worthington Road and SR 111.
- Inbound trucks coming from the south / east via SR 111 will be required to make a left-turn at the signalized intersection of Worthington Road and SR 111, a right-turn onto Dogwood Road from Worthington Road, a left-turn onto Harris Road from Dogwood Road, a right-turn onto SR 86 from Harris Road, and a right-turn into the site.

*Figure 1-2* shows the Project Site Plan.

#### **1.5 Proposed Project Opening Year and Analysis Scenarios**

The Project's opening year is projected to be 2025. The following analysis scenarios are analyzed in this study.

- Existing
- Opening Year (Existing + Cumulative Projects) without Project
- Opening Year + Project

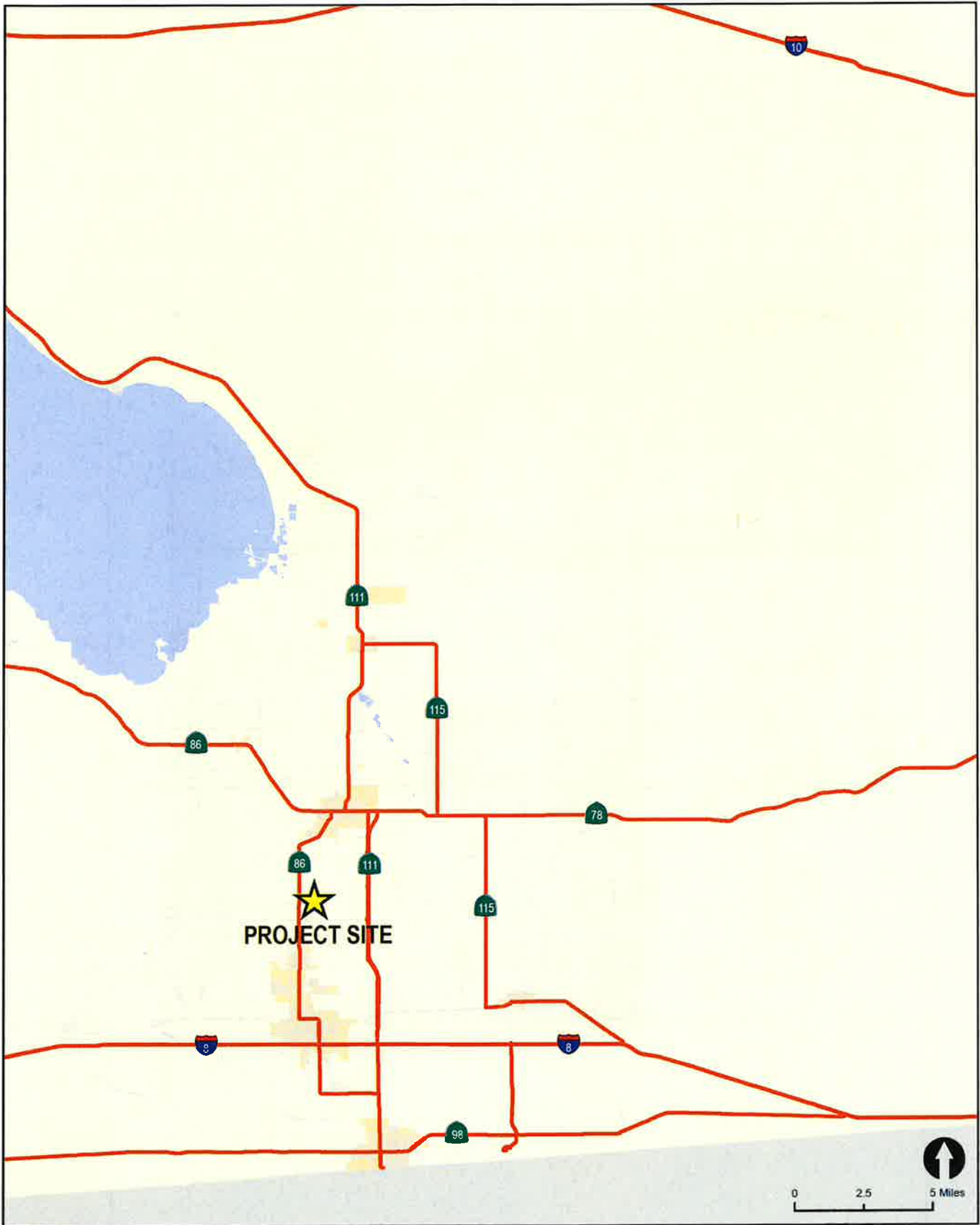

Figure 1-1





## 2.0 VEHICLE MILES TRAVELED ASSESSMENT

### 2.1 Background

In September 2013, the Governor’s Office signed SB 743 into law, starting a process that fundamentally changes the way transportation impact analysis is conducted under CEQA. These changes include the elimination of auto delay, level of service (LOS), and similar measurements of vehicular roadway capacity and traffic congestion as the basis for determining significant impacts. The justification for this paradigm shift is that Auto Delay/LOS impacts lead to improvements that increase roadway capacity and therefore induce more traffic and greenhouse gas emissions. The VMT standard for evaluating transportation impacts under CEQA became mandatory statewide on July 1, 2020.

Vehicle Miles Traveled (VMT) is defined as a measurement of miles traveled by vehicles within a specified region and for a specified time period. VMT is a measure of the use and efficiency of the transportation network. VMT’s are calculated based on individual vehicle trips generated and their associated trip lengths. VMT accounts for two-way (round trip) travel and is typically estimated on a weekday for the purpose of measuring potential transportation impacts.

### 2.2 Methodology

Imperial County has not yet formally developed guidelines or adopted significance criteria or technical methodologies for VMT analysis. Therefore, LLG utilized the Governor’s Office of Planning and Research (OPR) guidelines from the *Technical Advisory on Evaluating Transportation Impacts in CEQA*, December 2018, to develop technical methodologies for this Project.

The Project will generate trips from two distinct types of vehicles: heavy vehicles, which consist of the Project’s feedstock and compost trucks, and employee passenger vehicles. Heavy vehicles and passenger vehicles are classified as different vehicle types in the OPR guidelines, and are considered differently in regards to VMT analysis.

#### 2.2.1 Heavy Duty Vehicles

Per OPR guidelines, “vehicle miles traveled” refers to the amount and distance of *automobile* travel attributable to a project. Here the term “automobile” refers to on-road passenger vehicles, specifically cars and light trucks. VMT does not include trips from heavy-duty trucks. Therefore, the trips generated by the Project’s heavy-duty trucks are excluded from VMT analysis.

#### 2.2.2 Employee Passenger Vehicles

Many agencies use “screening thresholds” to quickly identify when a project should be expected to cause a less-than-significant impact. OPR contains a screening threshold for small projects which states that, “absent substantial evidence indicating that a project would generate a potentially significant level of VMT, or inconsistency with a Sustainable Communities Strategy (SCS) or general plan, projects that generate or attract fewer than 110 trips per day generally may be assumed to cause a less-than-significant transportation impact.”



## 3.0 LOCAL MOBILITY ANALYSIS

### 3.1 Analysis Approach and Methodology

In addition to the VMT analysis presented above, a Local Mobility Analysis (LMA) was also prepared that focuses on automobile delay and Level of Service (LOS). The LOS analysis was conducted to identify Project effects on the roadway operations in the Project study area and recommend Project improvements to address noted deficiencies.

#### 3.1.1 Level of Service

Level of service (LOS) is the term used to denote the different operating conditions which occur on a given roadway segment under various traffic volume loads. It is a qualitative measure used to describe a quantitative analysis taking into account factors such as roadway geometries, signal phasing, speed, travel delay, freedom to maneuver, and safety. Level of service provides an index to the operational qualities of a roadway segment or an intersection. Level of service designations range from A to F, with LOS A representing the best operating conditions and LOS F representing the worst operating conditions. Level of service designation is reported differently for signalized and unsignalized intersections.

#### 3.1.2 Intersections

**Signalized intersections** were analyzed under AM and PM peak hour conditions. Average vehicle delay was determined utilizing the methodology found in Chapter 19 of the *Highway Capacity Manual 6<sup>th</sup> Edition (HCM 6)*, with the assistance of the *Synchro* (version 10) computer software. The delay values (represented in seconds) were qualified with a corresponding intersection LOS. City of Escondido, City of San Marcos, and Caltrans location-specific signal timing information such as minimum greens, cycle lengths, splits for the freeway interchanges and real-time peak hour field observations were included in the analysis, where available.

**Unsignalized intersections** were analyzed under AM and PM peak hour conditions. Average vehicle delay and LOS was determined based upon the procedures found in Chapters 20 and 21 of the *HCM 6* with the assistance of the *Synchro* (version 10) computer software.

### 3.2 Substantial Effect Criteria

Imperial County does not have published substantial effect criteria. However, the County General Plan does state that the level of service (LOS) goal for intersections is to operate at LOS C or better. Therefore, if a segment degrades from LOS C or better to LOS D or worse with the addition of project traffic, the Project has a substantial effect. If the location operates at LOS D or worse with and without project traffic, the project has a substantial effect if the project causes the intersection delta to increase by more than two (2) seconds, or the V/C ratio to increase by more than 0.02.

**TABLE 3-1  
TRAFFIC IMPACT SUBSTANTIAL EFFECT CRITERIA**

Level of Service with Project <sup>a</sup>	Allowable Increase Due to Project Impacts <sup>b</sup>					
	Freeways		Roadway Segments		Intersections	Ramp Metering
	V/C	Speed (mph)	V/C	Speed (mph)	Delay (sec.)	Delay (min.)
D, E & F	0.01	1	0.02	1	2	2 <sup>c</sup>

**Footnotes:**

- a. All level of service measurements are based upon HCM procedures for peak-hour conditions. However, V/C ratios for Roadway Segments may be estimated on an ADT/24-hour traffic volume. The acceptable LOS for freeways, roadways, and intersections is generally "D" ("C" for undeveloped or not densely developed locations per jurisdiction definitions). For metered freeway ramps, LOS does not apply. However, ramp meter delays above 15 minutes are considered excessive.
- b. If a proposed project's traffic causes the values shown in the table to be exceeded, the Project has a substantial effect. These impact changes may be measured from appropriate computer programs or expanded manual spreadsheets. The project applicant shall then identify feasible mitigations (within the Traffic Impact Study [TIS] report) that will maintain the traffic facility at an acceptable LOS. If the LOS with the proposed project becomes unacceptable (see note a above), or if the project adds a significant amount of peak hour trips to cause any traffic queues to exceed on- or off-ramp storage capacities, the project applicant shall be responsible for mitigating Project's substantial effect.
- c. The allowable increase in delay at a ramp meter with more than 15 minutes of delay and freeway LOS E is 2 minutes and at LOS F is 1 minute.

**General Notes:**

1. V/C = Volume to Capacity Ratio
2. Speed = Arterial speed measured in miles per hour
3. Delay = Average stopped delay per vehicle measured in seconds for intersections, or minutes for ramp meters.
4. LOS = Level of Service

## 4.0 EXISTING CONDITIONS

Effective evaluation of the traffic impacts associated with the proposed project requires an understanding of the existing transportation system within the project area. *Figure 4-1* shows an existing conditions diagram, including signalized/unsignalized intersections and lane configurations.

### 4.1 Study Area

The study area includes the following intersections based on the anticipated distribution of the Project traffic and areas of potential effect:

1. Keystone Road / SR 86
2. Keystone Road / Dogwood Road
3. Keystone Road / SR 111
4. SR 86 / North Project Driveway (future)
5. SR 86 / South Project Driveway (future)
6. Harris Road / SR 86
7. Harris Road / Dogwood Road
8. Harris Road / SR 111
9. Worthington Road / SR 86
10. Worthington Road / Dogwood Road
11. Worthington Road / SR 111

### 4.2 Existing Transportation Conditions

The facilities analyzed in this report fall under the jurisdiction of the Imperial County. The following is a brief description of the streets in the project area:

**Keystone Road** is classified as a two-lane undivided Collector on the Imperial County Circulation Element. It is currently built as an east-west two-lane undivided roadway. The posted speed limit is 55 mph. There are no bus stops provided and on-street parking is prohibited.

**Harris Road** is classified as a four-lane undivided Collector on the Imperial County Circulation Element. It is currently built as an east-west two-lane undivided roadway. The posted speed limit is 55 mph. There are no bike lanes or bus stops provided and on-street parking is prohibited.

**Worthington Road** is classified as a two-lane undivided Collector on the Imperial County Circulation Element. It is currently built as an east-west two-lane undivided roadway. There is no posted speed limit, neither bike lanes nor bus stops are provided and curbside parking is prohibited.

**State Route 86** is classified as a four-lane divided Expressway on the Imperial County Circulation Element. It is currently built as a north-south four-lane divided roadway. The posted speed limit is 45 MPH within the project study area. Neither bike lanes nor bus stops are provided and curbside parking is prohibited.





**TABLE 4-1  
EXISTING INTERSECTION OPERATIONS**

Intersection	Control Type	Movement / Approach	Peak Hour	Delay <sup>a</sup>	LOS <sup>b</sup>
1. Keystone Road / SR 86	Signal	Overall	AM	17.3	B
			PM	18.5	B
2. Keystone Road / Dogwood Road	AWSC <sup>d</sup>	Overall	AM	8.8	A
			PM	10.6	B
3. Keystone Road / SR 111	Signal	Overall	AM	14.8	B
			PM	14.1	B
4. SR 86 / N. Project Driveway	DNE <sup>e</sup>	-	AM	-	-
			PM	-	-
5. SR 86 / S. Project Driveway	DNE <sup>e</sup>	-	AM	-	-
			PM	-	-
6. Harris Road / SR 86	MSSC <sup>c</sup>	Worst-Case	AM	0.0	A
			PM	0.0	A
7. Harris Road / Dogwood Road	MSSC <sup>c</sup>	Worst-Case	AM	12.6	B
			PM	13.6	B
8. Harris Road / SR 111	MSSC <sup>c</sup>	Worst-Case	AM	<b>31.3</b>	<b>D</b>
			PM	<b>37.7</b>	<b>E</b>
9. Worthington Road / SR 86	Signal	Overall	AM	<b>44.5</b>	<b>D</b>
			PM	<b>48.9</b>	<b>D</b>
10. Worthington Road / Dogwood Road	AWSC <sup>d</sup>	Overall	AM	12.9	B
			PM	11.8	B
11. Worthington Road / SR 111	Signal	Overall	AM	18.8	B
			PM	11.6	B

**Footnotes:**

- a. Average delay expressed in seconds per vehicle.
- b. Level of Service.
- c. MSSC – Minor Street Stop Controlled intersection. Worst-case LOS and delay reported.
- d. AWSC – All-Way Stop Controlled intersection. Overall LOS and delay reported.
- e. Intersection does not exist under Existing conditions.

SIGNALIZED		UNSIGNALIZED	
Delay	LOS	Delay	LOS
0.0 ≤ 10.0	A	0.0 ≤ 10.0	A
10.1 to 20.0	B	10.1 to 15.0	B
20.1 to 35.0	C	15.1 to 25.0	C
35.1 to 55.0	D	25.1 to 35.0	D
55.1 to 80.0	E	35.1 to 50.0	E
≥ 80.1	F	≥ 50.1	F

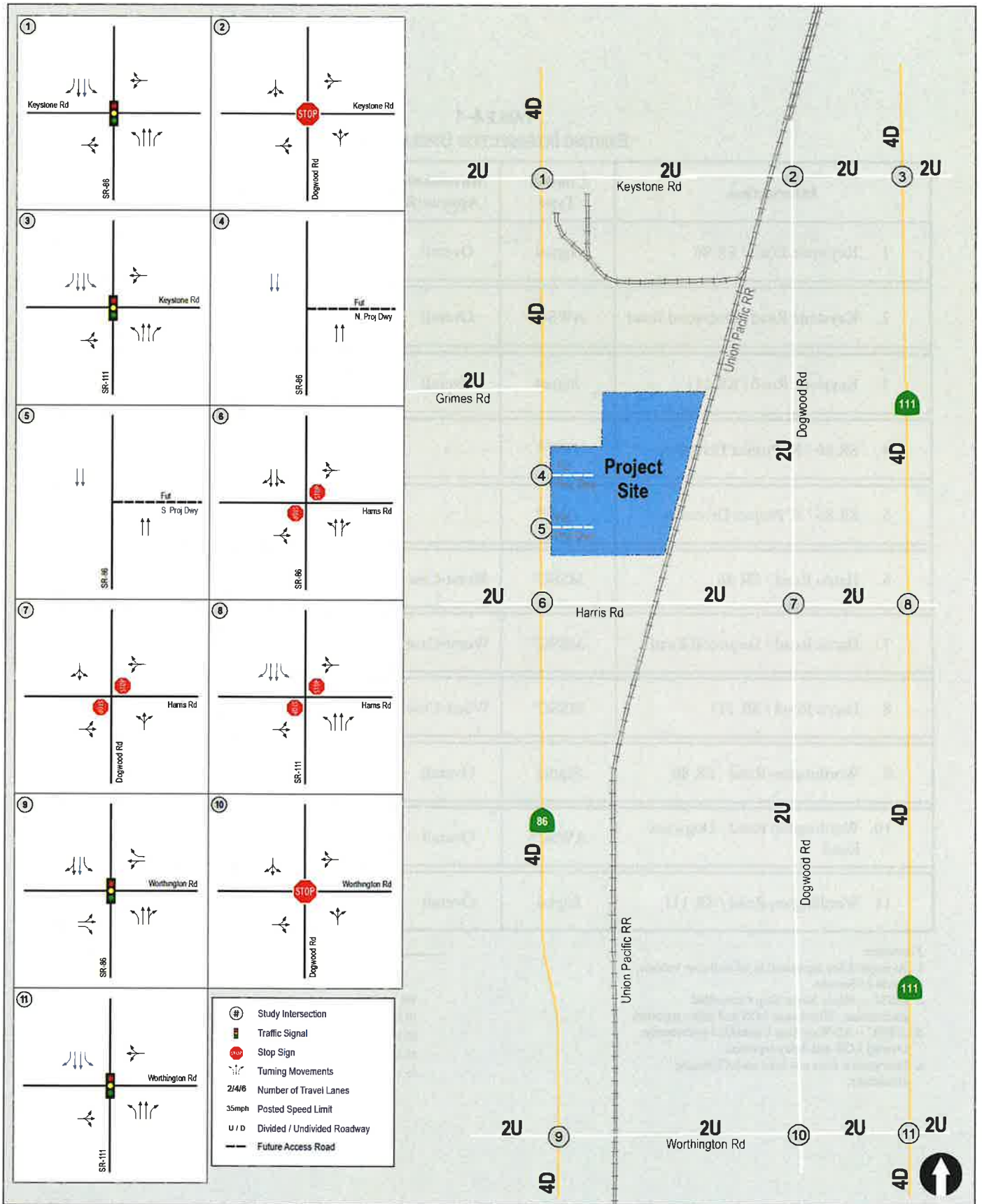

Figure 4-1

**Existing Conditions Diagram**

**EEC ORIGINAL PKG**

Green Valley Logistics Center

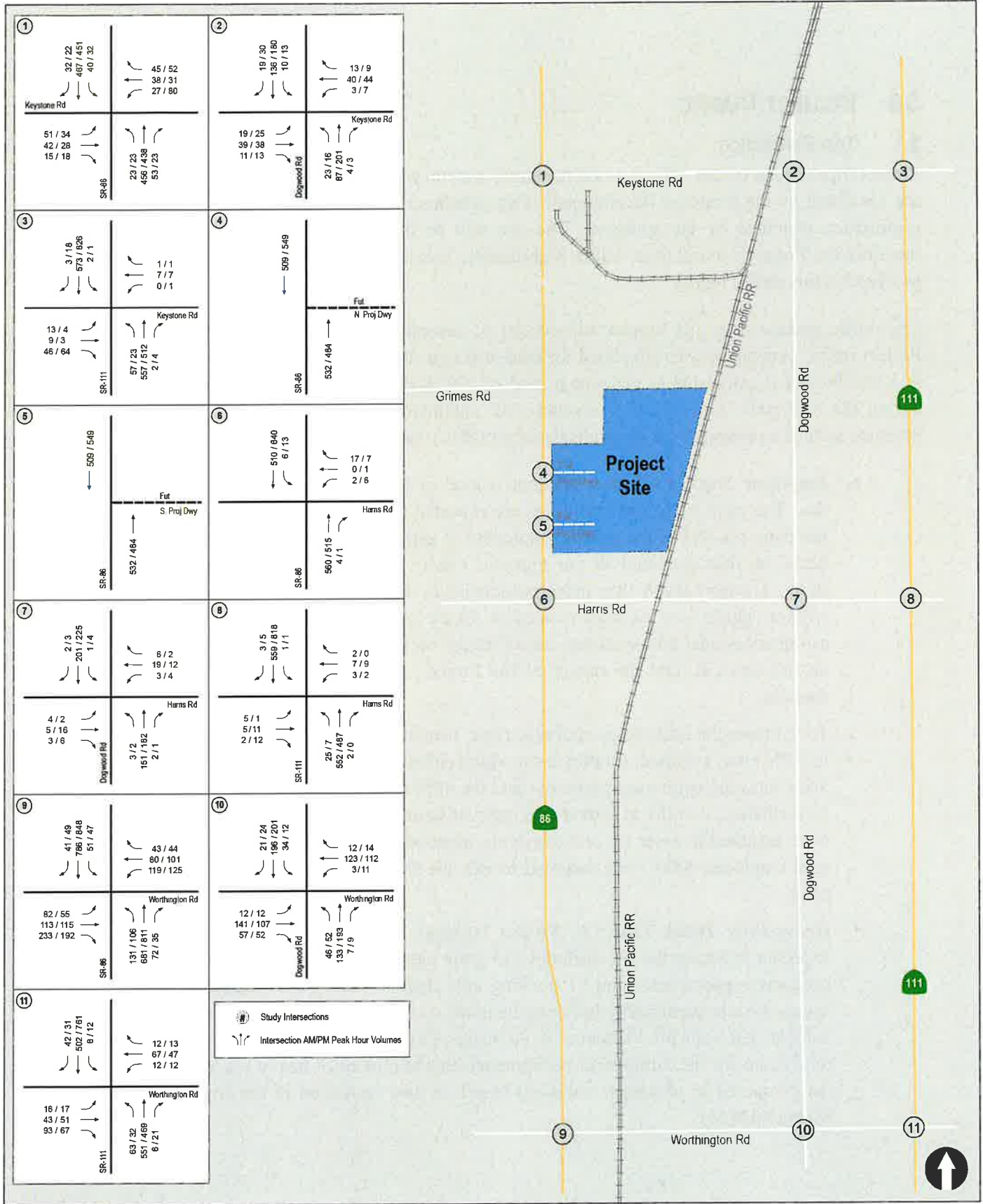

Figure 4-2  
**Existing Traffic Volumes**

## 5.0 PROJECT TRAFFIC

### 5.1 Trip Generation

Project trips consist of vehicular trips on the street system, which begin or end at the Project site and are generated by the proposed development. Trip generation estimates for the Project are based on information provided by the applicant. The site will be developed incrementally over time and therefore the Project's initial trips will be significantly less than the Project buildout traffic volumes analyzed in this traffic report.

The traffic generated by the Project will consist of several unique trip types as described below. Project traffic generation was calculated for each trip type as shown in *Table 5-1*. As seen in *Table 5-1*, the Project is calculated to generate a total of 979 ADT, with 42 inbound / 31 outbound trips during the AM peak hour, and 31 inbound / 42 outbound trips during the PM peak hour. The volumes include a passenger car equivalence factor (PCE), as discussed below.

- **Employee Trips:** At Project buildout, a total of 56 on-site employees are expected each day. The majority of the employees are expected to drive alone in their own vehicle (i.e., not carpool). 9% of the on-site employees (5 employees total) were assumed to carpool based on data provided in the *Imperial County Transportation Commission Regional Active Transportation Plan* (excerpt included in *Appendix E*). A trip rate of 2.1 ADT per worker vehicle was assumed to account for the trips to and from the Project site as well as the occasional mid-workday errand. Based on the location of the site, the provision of on-site services, and the nature of the Project, mid-workday trips are expected to be sporadic.

To estimate the peak hour employee trips, two-shifts per day (5AM to 1PM, and 11AM to 7 PM) was assumed. Employees working either of these shifts would avoid the 7AM to 9AM morning commuter peak hour and the 4PM to 6PM afternoon commuter peak hour. Nevertheless, in order to provide a conservative analysis, 10% of the total employee ADT were assumed to enter the site (traveling inbound) during the AM peak, and 10% of the total employee ADT were assumed to exit the site (traveling outbound) during the PM peak.

- **Heavy-Duty Truck Trips:** At Project buildout, a total of 218 heavy-duty trucks are expected to access the site each day (53 grain elevator trucks, 33 fuel trucks, 41 railed-in products export trucks, and 91 trucking only trucks). Heavy-duty trucks are assumed to access the site consistently between the hours of 5AM and 7PM (approximately 16 heavy vehicles per hour for 14-hours). A Passenger Car Equivalence (PCE) of 2.0 was applied to account for the diminished performance characteristics of heavy trucks in traffic flow (as compared to passenger vehicles) based on data contained in the Highway Capacity Manual (HCM).



## 5.2 Trip Distribution and Assignment

Access to the site will be provided via two driveways to SR 86. The north driveway will accommodate right-turn only egress and the south driveway will accommodate right-turn only ingress. Project trip distribution was developed based on other traffic studies conducted in the area, existing traffic patterns, the regional roadway network, Project specific origin / destination considerations, the location of the Project driveways, and the restricted right-turn in and right-turn out access.

As a Project feature, the Project will require inbound and outbound heavy trucks to adhere to the following designated truck routes:

- When leaving the site, heavy trucks heading to the south / east via SR 111 will be required to make a right-turn out of the site onto SR 86, a right-turn from SR 86 to Keystone Road, a right-turn from Keystone Road to Dogwood Road, a left-turn from Dogwood Road onto Worthington Road, and a right-turn at the signalized intersection of Worthington Road and SR 111.
- Inbound trucks coming from the south / east via SR 111 will be required to make a left-turn at the signalized intersection of Worthington Road and SR 111, a right-turn onto Dogwood Road from Worthington Road, a left-turn onto Harris Road from Dogwood Road, a right-turn onto SR 86 from Harris Road, and a right-turn into the site.

Because of these heavy truck route restrictions, two separate Project trip distribution figures were developed: one for on-site employees and one for heavy vehicles.

*Figure 5-1a* depicts the Project trip distribution for Employees, and *Figure 5-1b* depicts the Project trip distribution for heavy trucks. *Figure 5-2a* depicts the Project trip assignment for Employees and *Figure 5-2b* depicts the Project trip assignment for heavy trucks. *Figure 5-3* depicts the total Project trip assignment.

**TABLE 5-1  
PROJECT TRIP GENERATION**

Number and Type of Trips	Daily Trips			AM Peak Hour (w/PCE)			PM Peak Hour (w/PCE) <sup>d</sup>		
	ADT <sup>a</sup>	PCE <sup>b</sup>	PCE Adjusted ADT	In	Out	Total	In	Out	Total
<b>Phase 1</b>									
20 Worker Vehicles <sup>c</sup>	42	1.0	42	4	0	4	0	4	4
48 Grain Elevator Trucks	96	2.0	192	7	7	14	7	7	14
24 Fuel trucks	48	2.0	96	3	3	6	3	3	6
8 Railed-in Products Export Trucks	16	2.0	32	1	1	2	1	1	2
20 Trucking Only Trucks	40	2.0	80	3	3	6	3	3	6
<b>Phase 1 Subtotal</b>	<b>242</b>	<b>-</b>	<b>442</b>	<b>18</b>	<b>14</b>	<b>32</b>	<b>14</b>	<b>18</b>	<b>32</b>
<b>Phase 2</b>									
31 Worker Vehicles <sup>c</sup>	65	1.0	65	7	0	7	0	7	7
5 Grain Elevator Trucks	10	2.0	20	1	1	2	1	1	2
9 Fuel trucks	18	2.0	36	1	1	2	1	1	2
33 Railed-in Products Export Trucks	66	2.0	132	5	5	10	5	5	10
71 Trucking Only Trucks	142	2.0	284	10	10	20	10	10	20
<b>Phase 2 Subtotal</b>	<b>301</b>	<b>-</b>	<b>537</b>	<b>24</b>	<b>17</b>	<b>41</b>	<b>17</b>	<b>24</b>	<b>41</b>
<b>Total Trips:</b>	<b>543</b>	<b>-</b>	<b>979</b>	<b>42</b>	<b>31</b>	<b>73</b>	<b>31</b>	<b>42</b>	<b>73</b>

**Footnotes:**

- a. Average Daily Trips
- b. Passenger Car Equivalents. Based on the *Highway Capacity Manual*, a Passenger Car Equivalent (PCE) factor of 2.0 was applied to the Project's heavy-truck trips.
- c. A total of 56 on-site employees are expected each day at Project buildout. Based on data provided in the *Imperial County Transportation Commission Regional Active Transportation Plan*, February 2022, 9% of the on-site employees (5 people total) were assumed to carpool with other employees. A trip rate of 2.1 ADT per worker vehicle was assumed to account for the trips to and from the Project site as well as the occasional mid-workday errand. Based on the location of the site, the provision of on-site services, and the nature of the Project, mid-workday trips are expected to be very sporadic.
- d. Heavy-duty trucks are assumed to access the site consistently between the hours of 5AM and 7PM (approximately 16 heavy vehicles per hour for 14-hours at Project buildout).

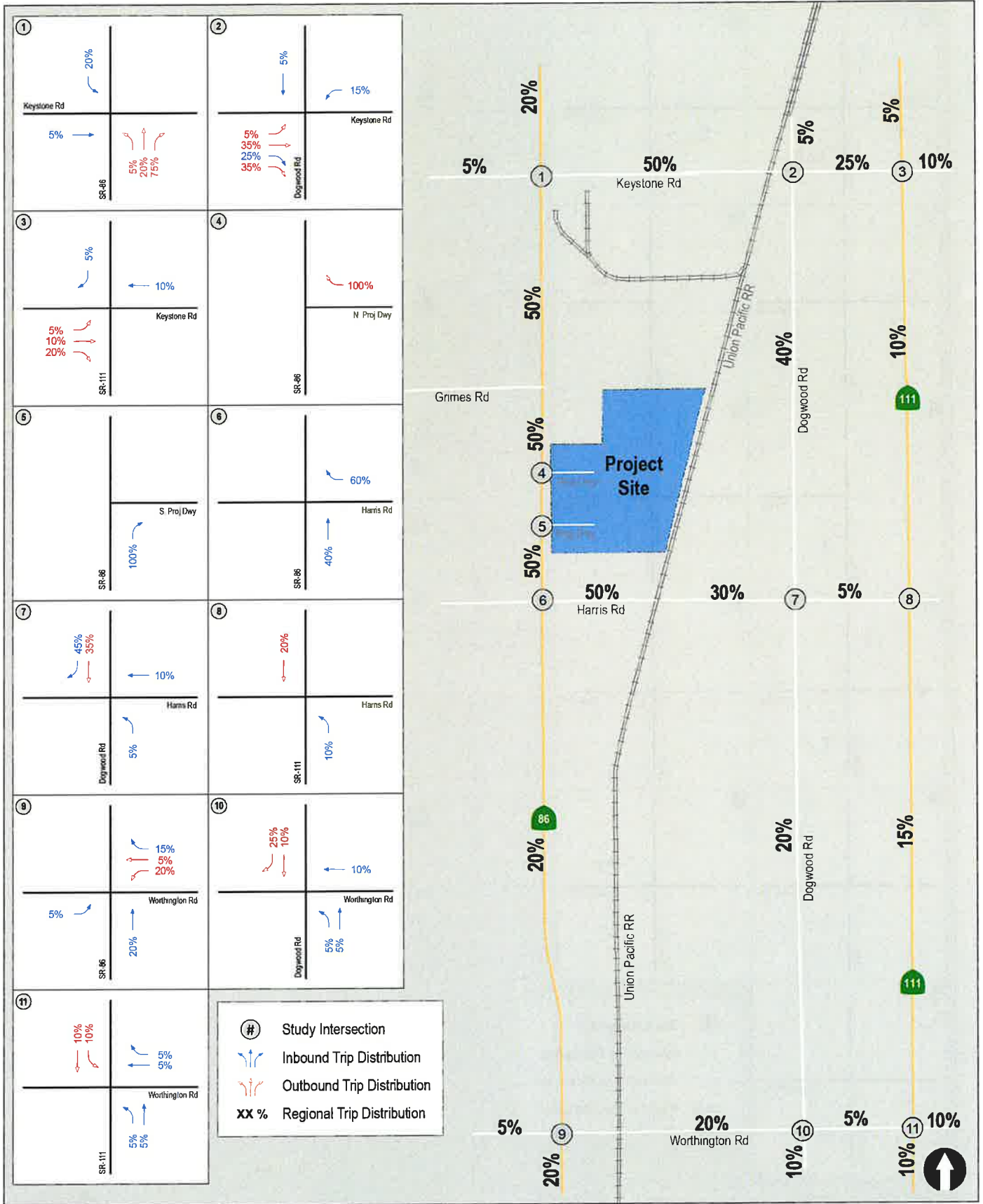

Figure 5-1a

**Project Traffic Distribution**

(Employee Trips)

**EEC ORIGINAL PKG**

Green Valley Logistics Center

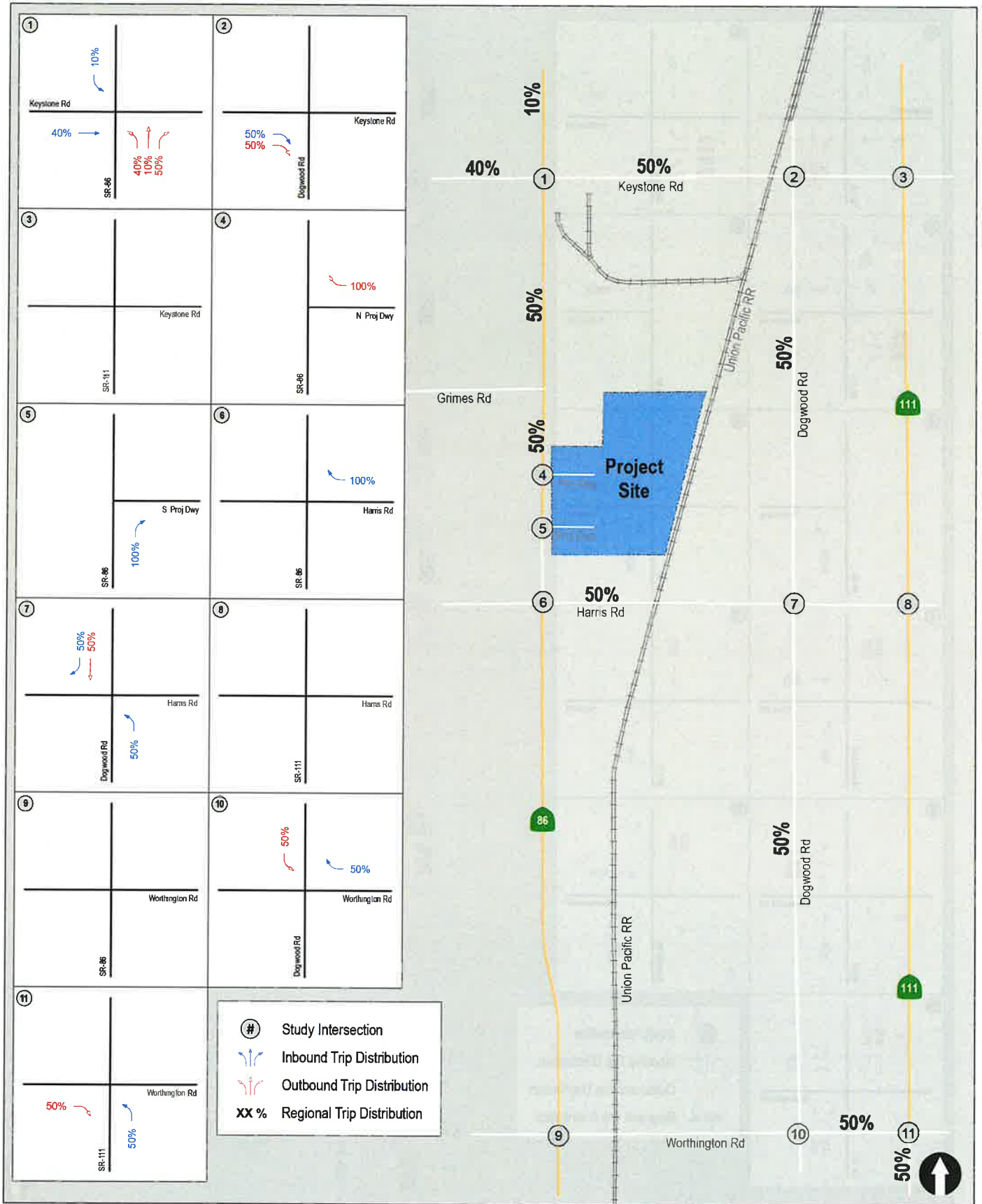

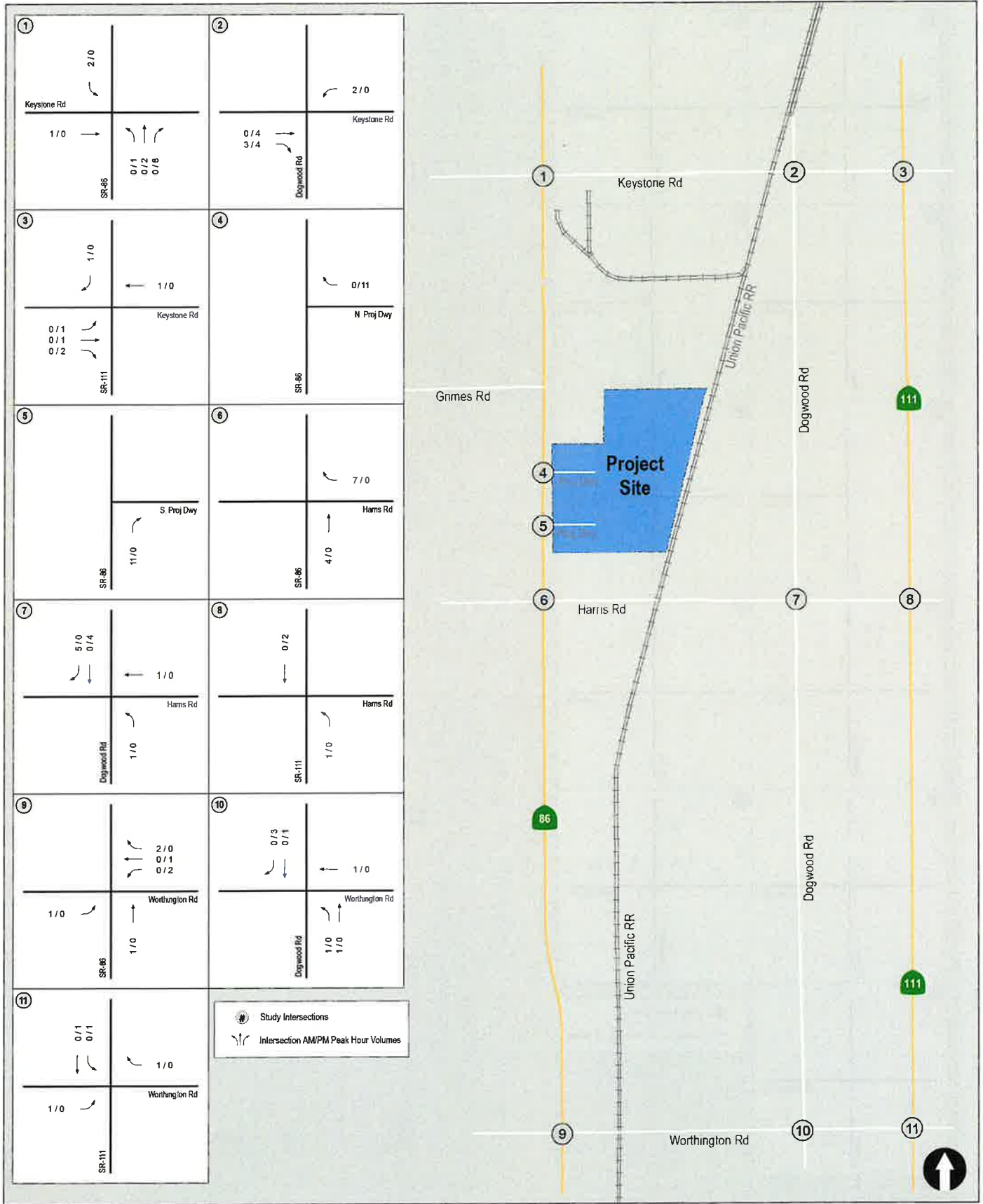

Figure 5-2a

**Project Traffic Volumes**

(Employee Trips)

**EEC ORIGINAL PKG**  
Green Valley Logistics Center





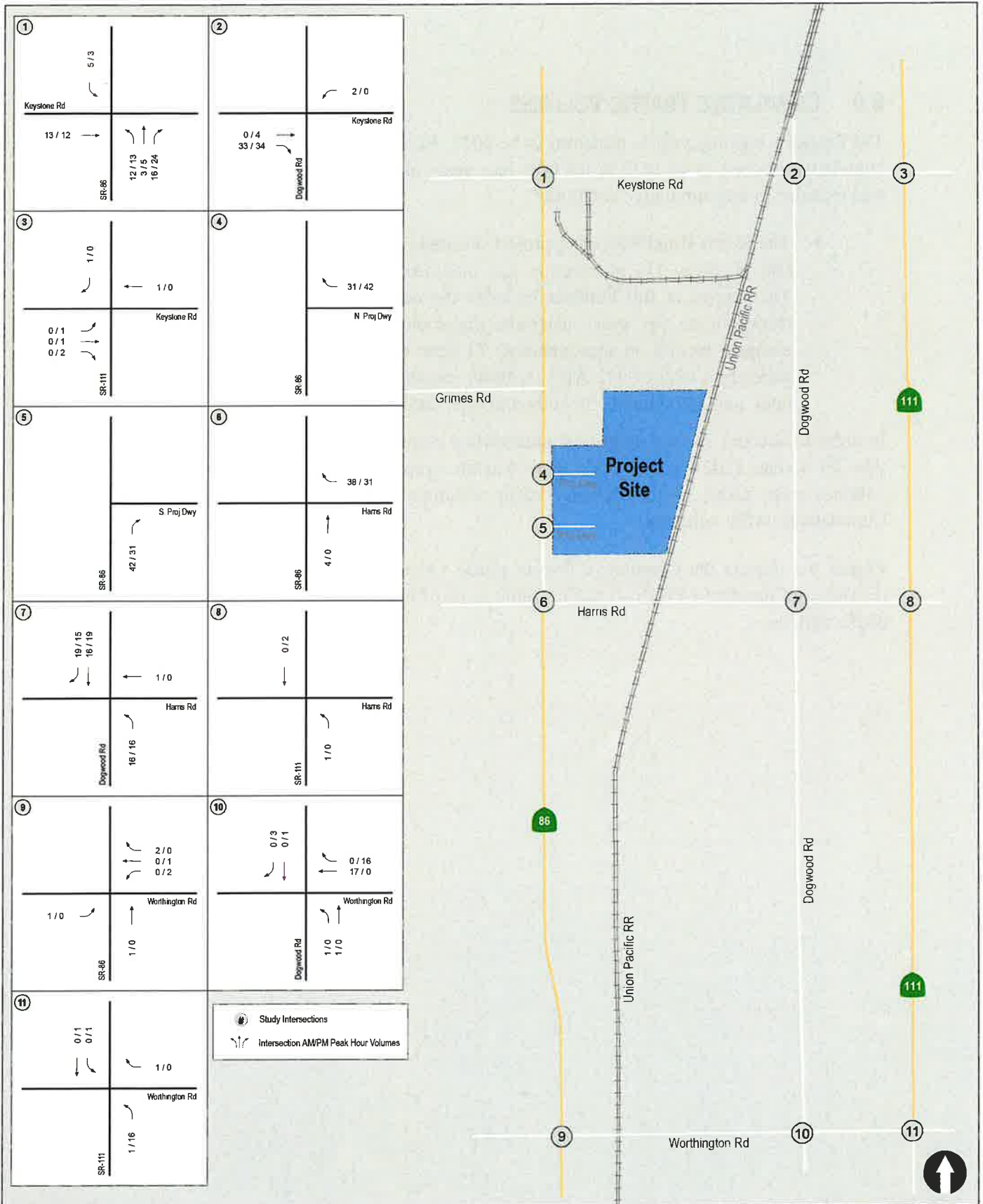

Figure 5-3

**Total Project Traffic Volumes**

**EEC ORIGINAL PKG**  
Green Valley Logistics Center

## 6.0 CUMULATIVE TRAFFIC VOLUMES

The Project's opening year is projected to be 2025. Research was conducted to identify any known cumulative projects to be built in the next four years in the Project vicinity. The following project was included in the cumulative condition:

- The Harris Road Recycling project, located on the northwest corner of the Harris Road / Old Highway 111 intersection was included in the cumulative traffic volume forecast. The project at full buildout includes the development of a 2,500 ton per day (TPD) (600,000 ton per year) anaerobic digestion (AD) facility and an enclosed, intensive compost facility on approximately 73 acres of vacant land. The project is calculated to generate a total of 922 ADT, with 39 inbound / 29 outbound trips during the AM peak hour, and 29 inbound / 39 outbound trips during the PM peak hour.

In order to account for any additional unidentified cumulative projects, a growth factor of 2% per year for 4-years (2021 to 2025; 8% total) was also applied to the Existing traffic volumes. These volumes were added to the Existing traffic volumes to obtain the Opening Year (Existing + Cumulative) traffic volumes.

*Figure 6-1* depicts the Cumulative Project traffic volumes, *Figure 6-2* depicts the Opening Year (Existing + Cumulative Projects) traffic volumes, and *Figure 6-3* depicts the Opening Year + Project traffic volumes.

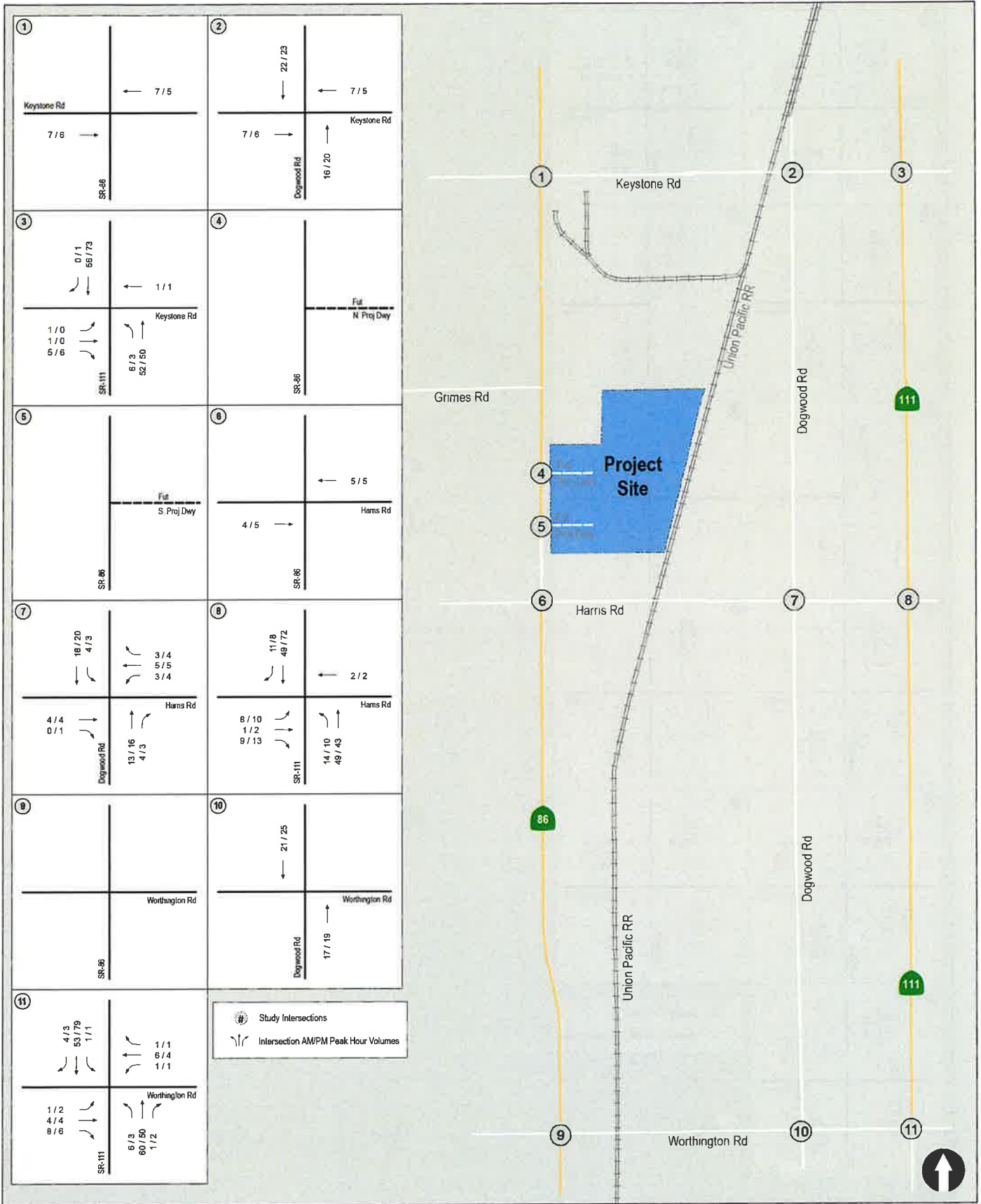
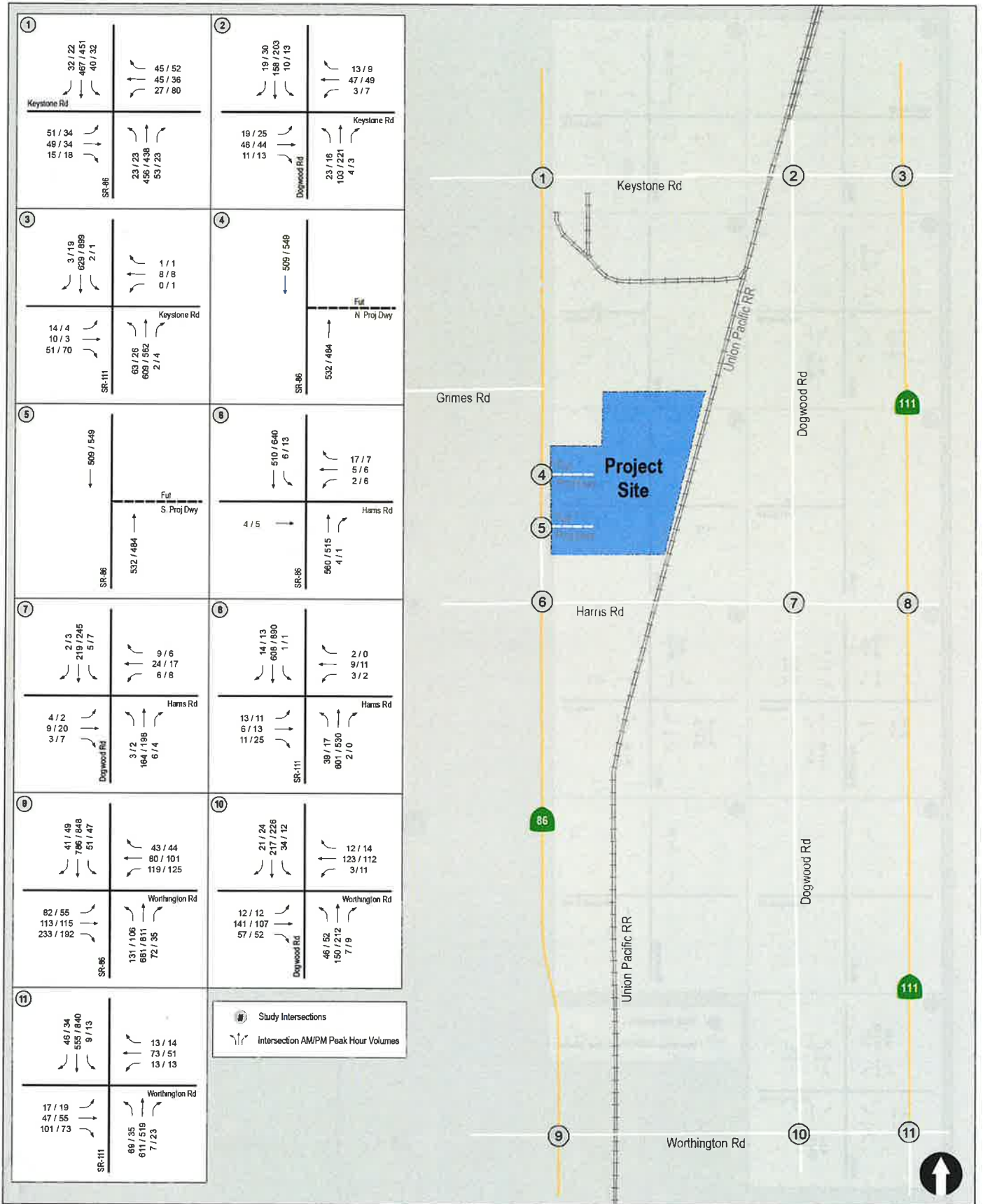

Figure 6-1  
**Cumulative Projects Traffic Volumes**



N:\3520\Figures  
Date: 4/3/2023  
Time: 1:27 PM

Figure 6-2  
**Opening Year (Existing + Cumulative Projects) Traffic Volumes**



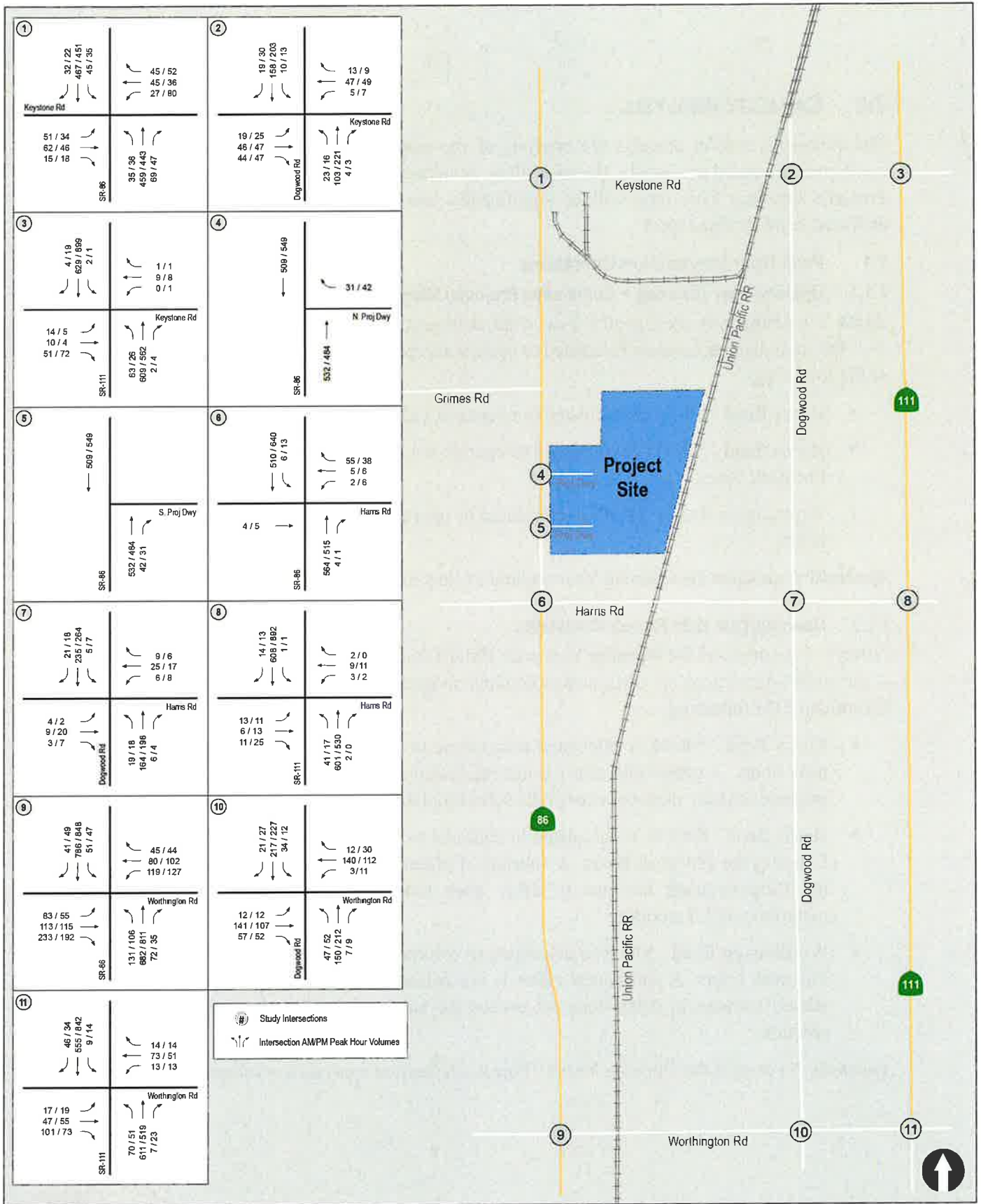

Figure 6-3

Opening Year + Project Traffic Volumes

EEC ORIGINAL PKG

Green Valley Logistics Center



**TABLE 7-1  
OPENING YEAR INTERSECTION OPERATIONS**

Intersection	Control Type	Movement/ Approach	Peak Hour	Opening Year		Opening Year + Project		Δ <sup>c</sup>
				Delay <sup>a</sup>	LOS <sup>b</sup>	Delay <sup>a</sup>	LOS <sup>b</sup>	
1. Keystone Road / SR 86	Signal	Overall	AM	17.6	B	18.2	B	0.6
			PM	18.7	B	19.2	B	0.5
2. Keystone Road / Dogwood Rd	AWSC <sup>d</sup>	Overall	AM	9.1	A	9.3	A	0.2
			PM	11.4	B	11.9	B	0.5
3. Keystone Road / SR 111	Signal	Overall	AM	15.2	B	15.6	B	0.4
			PM	14.8	B	14.9	B	0.1
4. SR 86 / N. Project Driveway <sup>e</sup>	MSSC <sup>c</sup>	Worst-Case	AM	-	-	10.5	B	-
			PM	-	-	10.4	B	-
5. SR 86 / S. Project Driveway <sup>e</sup>	MSSC <sup>c</sup>	Worst-Case	AM	-	-	0.0	A	-
			PM	-	-	0.0	A	-
6. Harris Road / SR 86	MSSC <sup>c</sup>	Worst-Case	AM	<b>31.3</b>	<b>D</b>	<b>31.5</b>	<b>D</b>	<b>0.2</b>
			PM	<b>33.4</b>	<b>D</b>	<b>33.4</b>	<b>D</b>	<b>0.0</b>
7. Harris Road / Dogwood Road	MSSC <sup>c</sup>	Worst-Case	AM	13.5	B	14.8	B	1.3
			PM	14.4	B	15.8	C	1.4
8. Harris Road / SR 111	MSSC <sup>c</sup>	Worst-Case	AM	<b>43.1</b>	<b>E</b>	<b>44.0</b>	<b>E</b>	<b>0.9</b>
			PM	<b>50.3</b>	<b>F</b>	<b>50.3</b>	<b>F</b>	<b>0.0</b>
9. Worthington Road / SR 86	Signal	Overall	AM	<b>44.5</b>	<b>D</b>	<b>44.5</b>	<b>D</b>	<b>0.0</b>
			PM	<b>48.9</b>	<b>D</b>	<b>49.4</b>	<b>D</b>	<b>0.5</b>
10. Worthington Road / Dogwood Road	AWSC <sup>d</sup>	Overall	AM	13.7	B	14.2	B	0.5
			PM	12.4	B	12.6	B	0.2
11. Worthington Road / SR 111	Signal	Overall	AM	19.7	B	19.7	B	0.0
			PM	12.2	B	13.0	B	0.8

**Footnotes:**

- a. Average delay expressed in seconds per vehicle.
- b. Level of Service.
- c. MSSC – Minor-Street Stop Controlled intersection. Worst case LOS and delay reported.
- d. AWSC – All-Way Stop Controlled intersection. Overall LOS and delay reported.
- e. Intersection does not exist under “without Project” conditions.

SIGNALIZED		UNSIGNALIZED	
Delay	LOS	Delay	LOS
0.0 ≤ 10.0	A	0.0 ≤ 10.0	A
10.1 to 20.0	B	10.1 to 15.0	B
20.1 to 35.0	C	15.1 to 25.0	C
35.1 to 55.0	D	25.1 to 35.0	D
55.1 to 80.0	E	35.1 to 50.0	E
≥ 80.1	F	≥ 50.1	F



**TECHNICAL APPENDICES**  
**GREEN VALLEY LOGISTICS CENTER**  
Imperial County, California  
July 14, 2023

LLG Ref. 3-22-3520

**Linscott, Law &  
Greenspan, Engineers**  
4542 Ruffner Street  
Suite 100  
San Diego, CA 92111  
858.300.8800 T  
858.300.8810 F  
[www.llgengineers.com](http://www.llgengineers.com)

**EEC ORIGINAL PKG**







# Intersection Turning Movement - Peak Hour Summary



<b>Location:</b>	#01	<b>File Name:</b>	ITM-22-010-01
<b>Intersection:</b>	SR-86 & Keystone Road	<b>Project:</b>	LLG Ref. 3-22-3520
<b>Date of Count:</b>	Tuesday, February 15, 2022	<b>Tomcat Grain Elevator</b>	

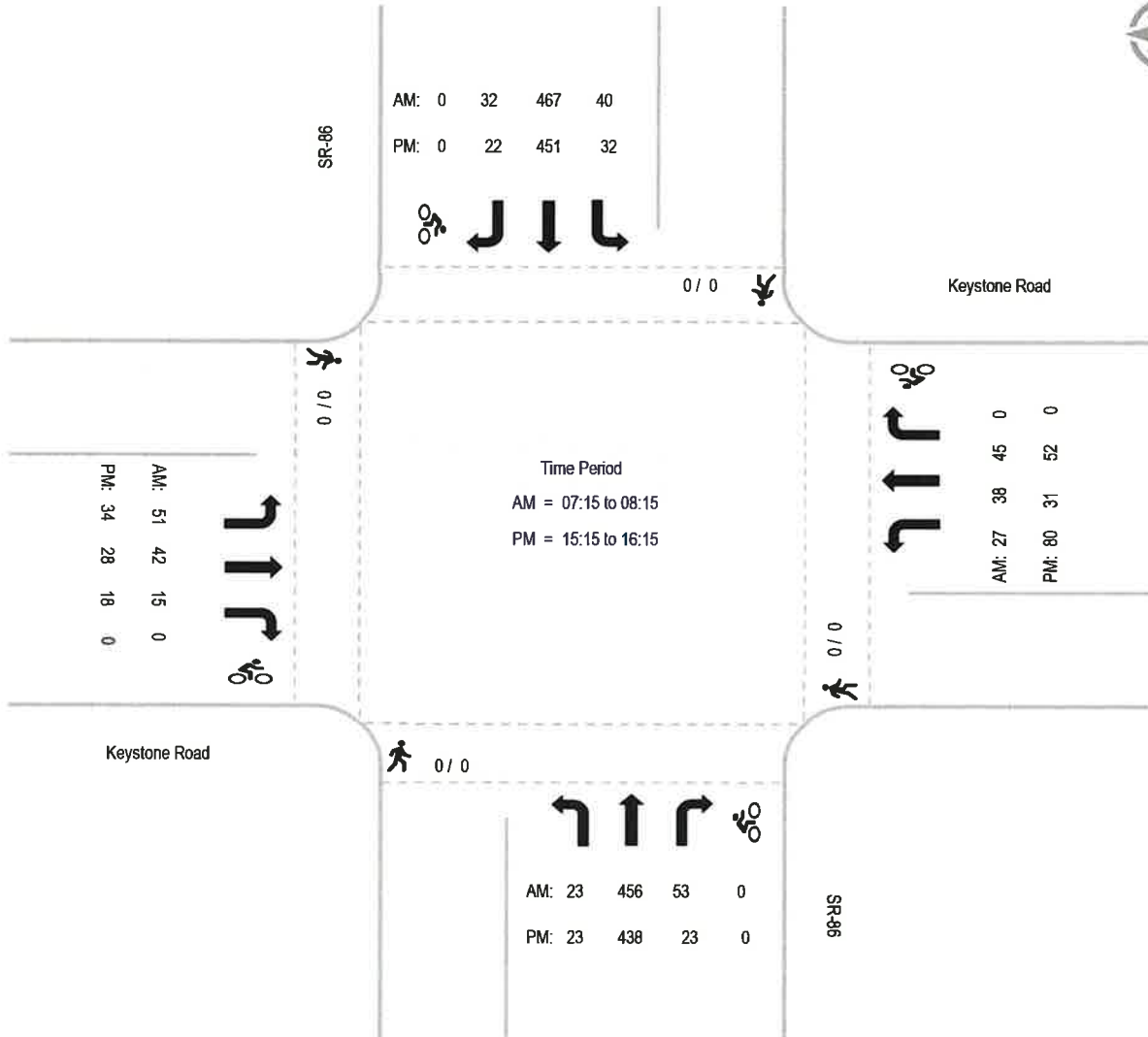

Report Generated by Bearcat Enterprises LLC, DBA "Count Data" | 619-987-5136 |

EEC ORIGINAL PKG

Counts Unlimited, Inc.  
 PO Box 1178  
 Corona, CA 92878  
 (951)268-6268

County of Imperial  
 N/S: Dogwood Road  
 E/W: Keystone Road  
 Weather: Clear

File Name : CIM\_Dog\_Key AM  
 Site Code : 05723269  
 Start Date : 3/22/2023  
 Page No : 2

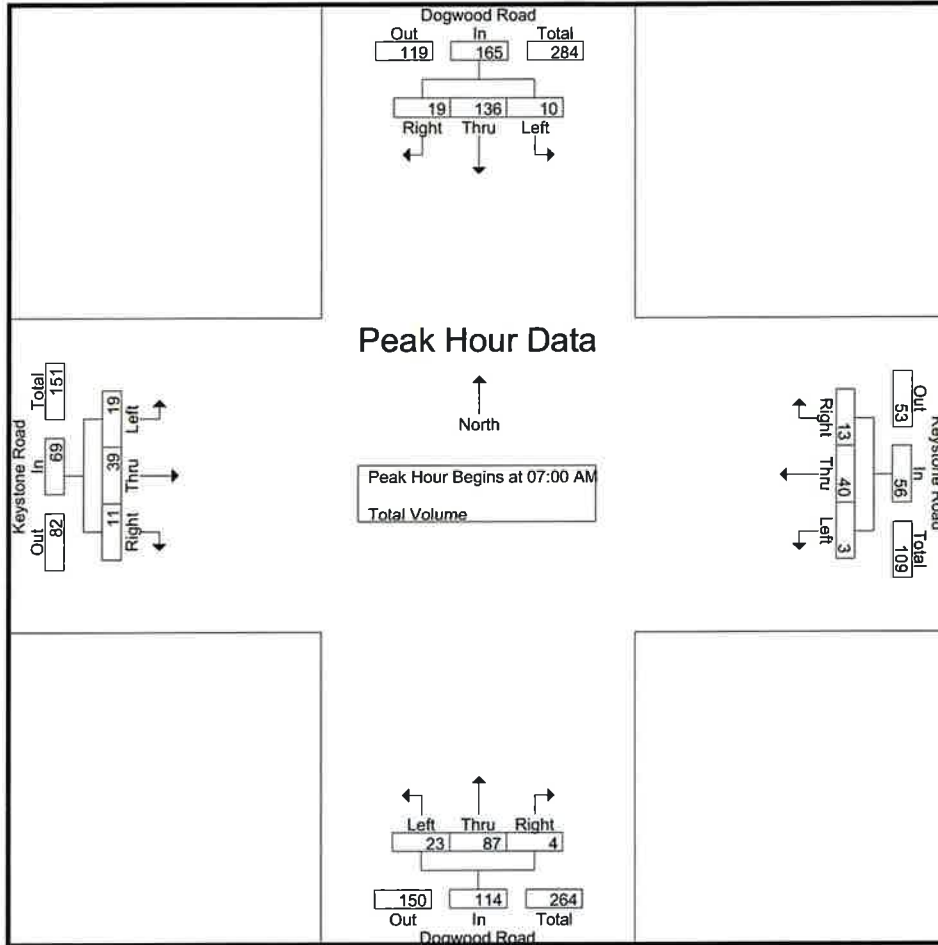

Peak Hour Analysis From 07:00 AM to 08:45 AM - Peak 1 of 1  
 Peak Hour for Each Approach Begins at:

	07:00 AM				07:00 AM				07:00 AM				07:00 AM			
+0 mins.	4	40	4	48	1	15	5	21	7	25	1	33	5	9	4	18
+15 mins.	4	35	6	45	0	5	2	7	4	26	0	30	2	6	4	12
+30 mins.	1	34	8	43	1	12	5	18	5	20	2	27	8	11	1	20
+45 mins.	1	27	1	29	1	8	1	10	7	16	1	24	4	13	2	19
Total Volume	10	136	19	165	3	40	13	56	23	87	4	114	19	39	11	69
% App. Total	6.1	82.4	11.5		5.4	71.4	23.2		20.2	76.3	3.5		27.5	56.5	15.9	
PHF	.625	.850	.594	.859	.750	.667	.650	.667	.821	.837	.500	.864	.594	.750	.688	.863

County of Imperial  
 N/S: Dogwood Road  
 E/W: Keystone Road  
 Weather: Clear

File Name : CIM\_Dog\_Key PM  
 Site Code : 05723269  
 Start Date : 3/22/2023  
 Page No : 2

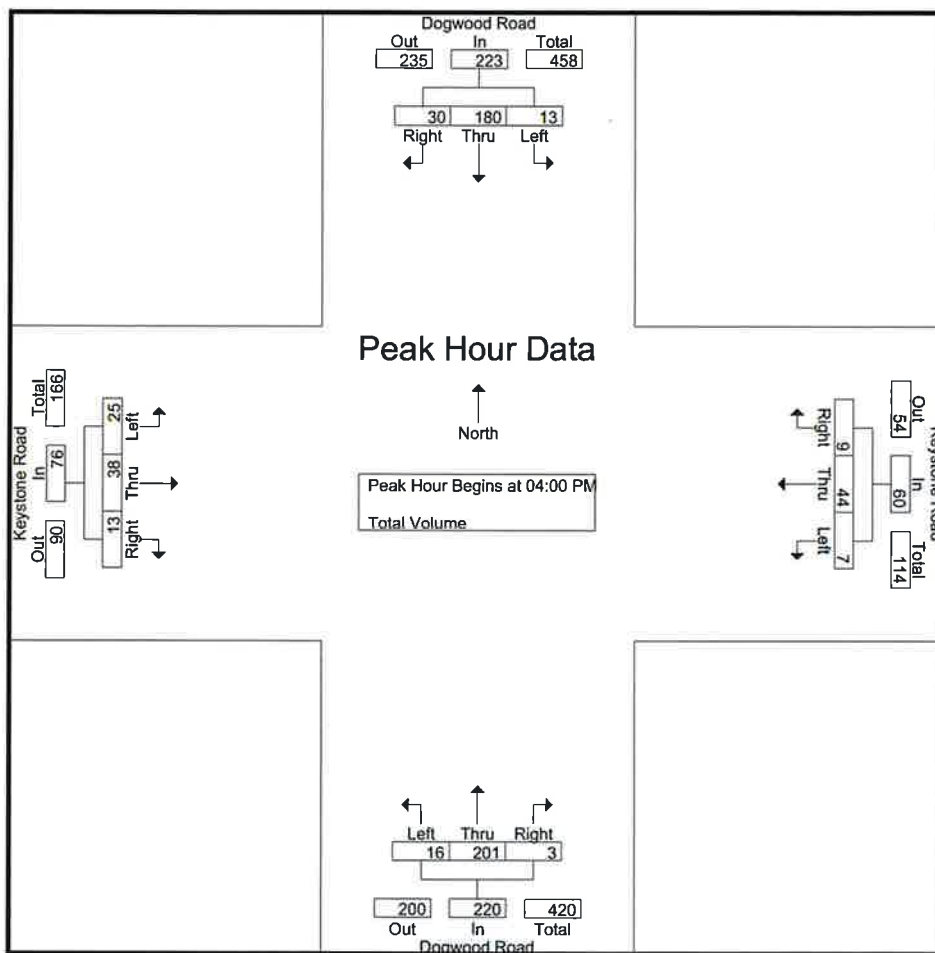

Peak Hour Analysis From 04:00 PM to 05:45 PM - Peak 1 of 1

Peak Hour for Each Approach Begins at:

	04:00 PM				04:00 PM				04:00 PM				04:00 PM			
+0 mins.	3	59	9	71	1	11	1	13	4	41	0	45	5	13	3	21
+15 mins.	2	51	5	58	2	11	3	16	4	67	1	72	8	15	3	26
+30 mins.	5	41	8	54	2	12	1	15	7	51	1	59	7	7	4	18
+45 mins.	3	29	8	40	2	10	4	16	1	42	1	44	5	3	3	11
Total Volume	13	180	30	223	7	44	9	60	16	201	3	220	25	38	13	76
% App. Total	5.8	80.7	13.5		11.7	73.3	15		7.3	91.4	1.4		32.9	50	17.1	
PHF	.650	.763	.833	.785	.875	.917	.563	.938	.571	.750	.750	.764	.781	.633	.813	.731





## Intersection Turning Movement - Peak Hour Summary



<b>Location:</b> #02	<b>File Name:</b> ITM-22-010-02
<b>Intersection:</b> SR-86 & Harris Road	<b>Project:</b> LLG Ref. 3-22-3520
<b>Date of Count:</b> Tuesday, February 15, 2022	<b>Tomcat Grain Elevator</b>

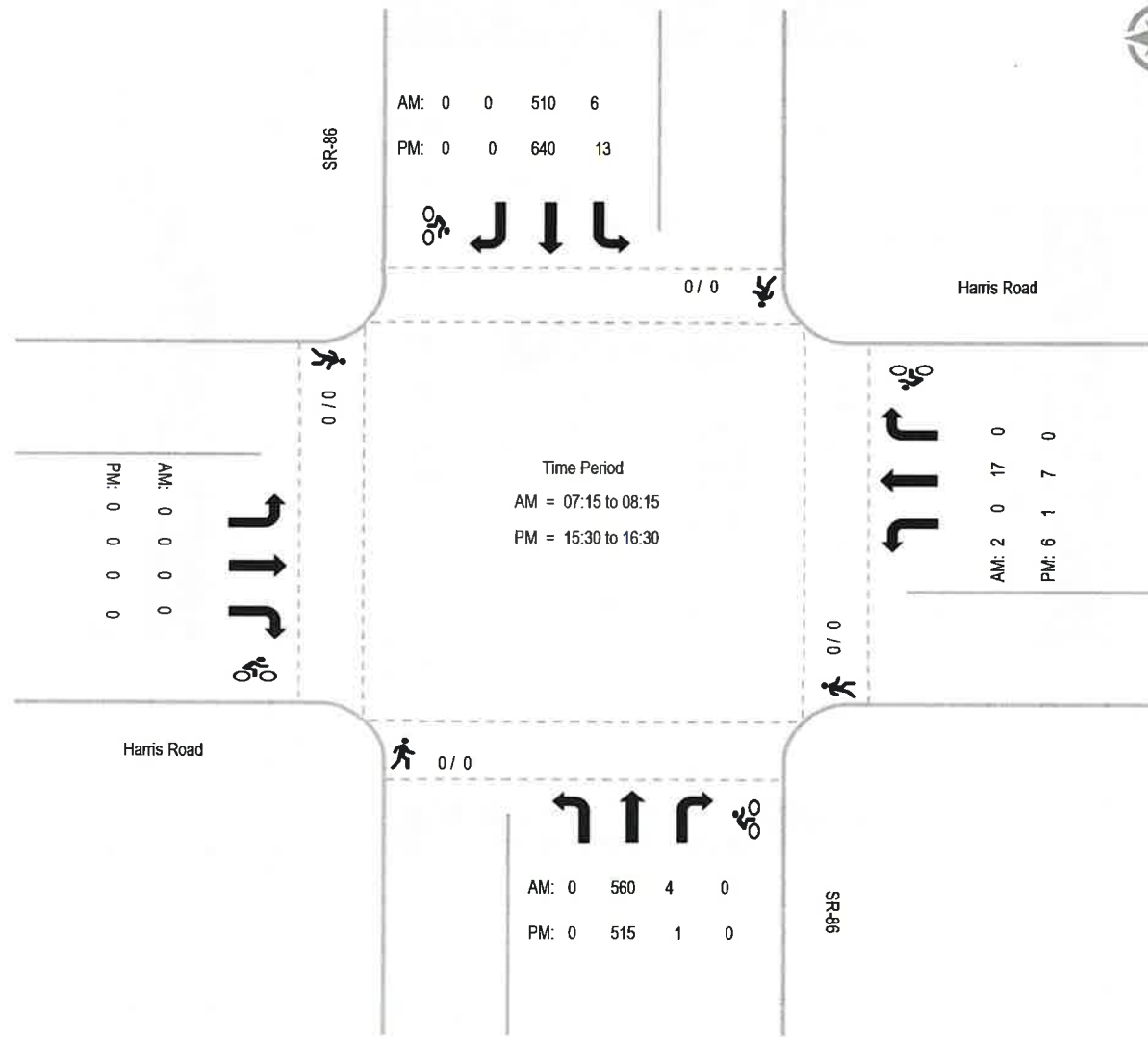

Report Generated by Bearcat Enterprises LLC, DBA "Count Data" | 619-987-5136 |





## Intersection Turning Movement - Peak Hour Summary



**Location:** #03  
**Intersection:** SR-86 & Worthington Road  
**Date of Count:** Tuesday, February 15, 2022

**File Name:** ITM-22-010-03  
**Project:** LLG Ref. 3-22-3520  
 Tomcat Grain Elevator

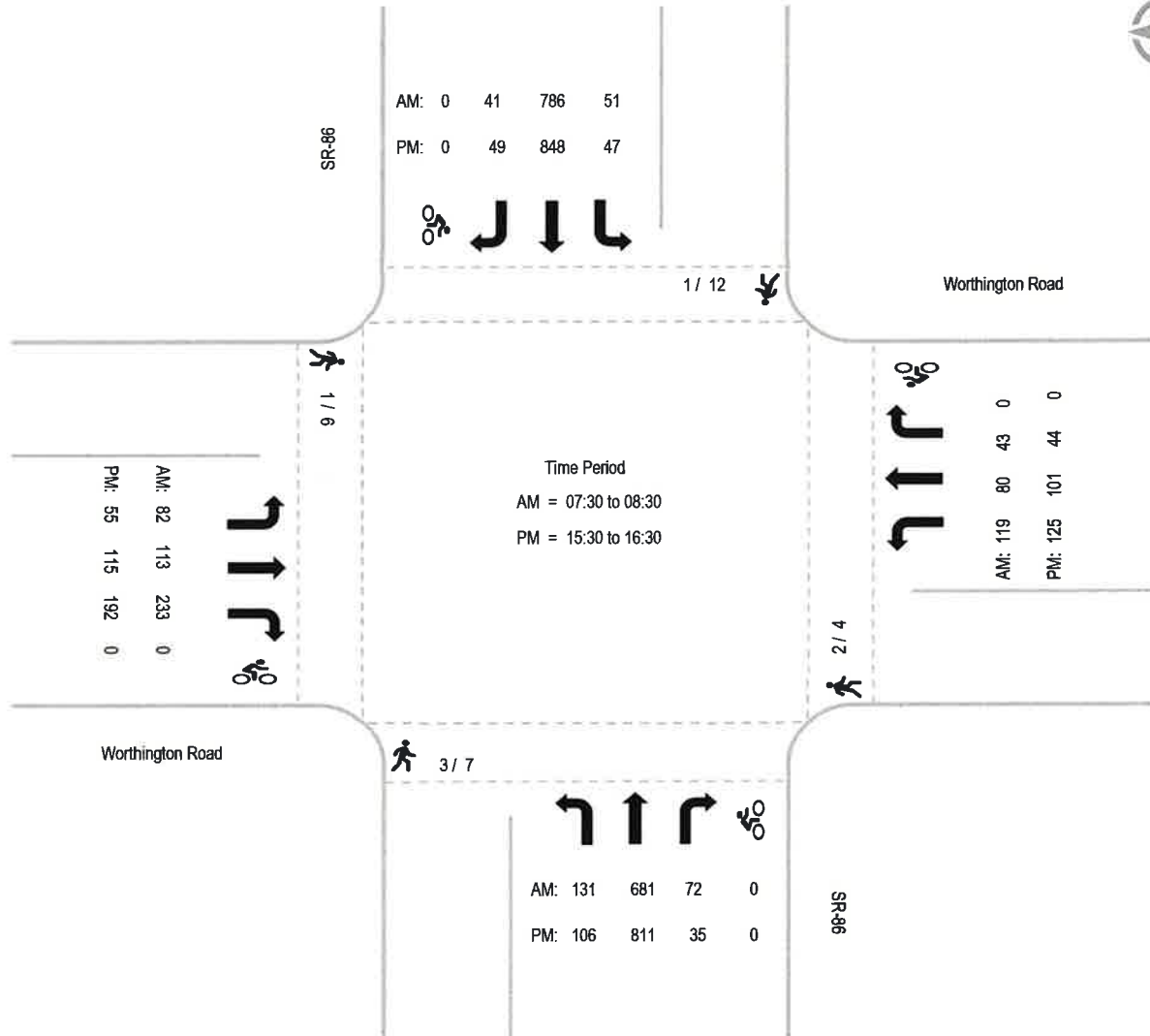

Report Generated by Bearcat Enterprises LLC, DBA "Count Data" | 619-987-5136 |

EEC ORIGINAL PKG



## Intersection Turning Movement - Peak Hour Summary



**Location:** #01  
**Intersection:** Dogwood Rd & West Worthington Rd  
**Date of Count:** Thursday January 05, 2023

**File Name:** ITM-23-004-01  
**Project:** LLG Ref. 3-22-3520  
 Tomcat Grain Elevator

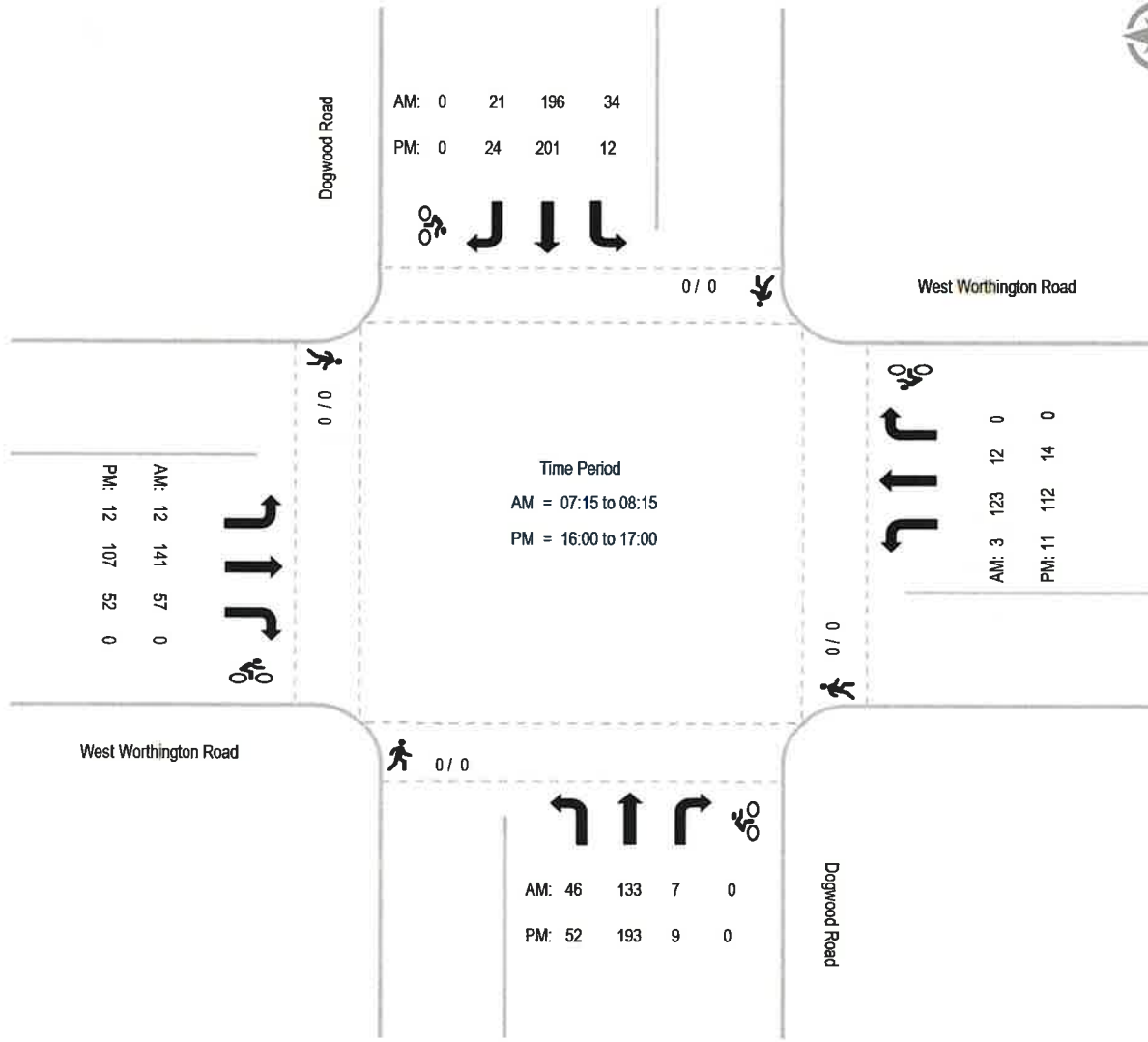

# SR-111 & Worthington Rd

## Peak Hour Turning Movement Count

ID: 21-040158-007  
City: Imperial

Day: Wednesday  
Date: 9/15/2021

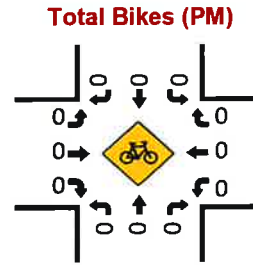
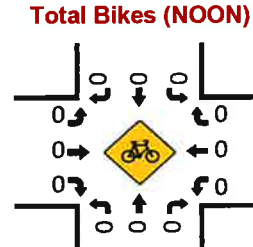
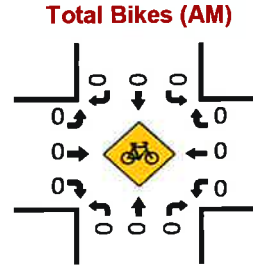
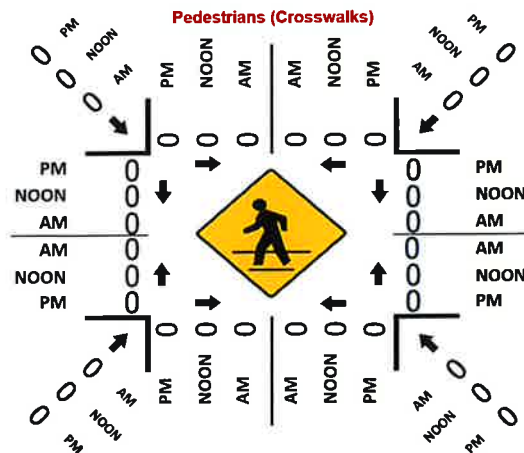
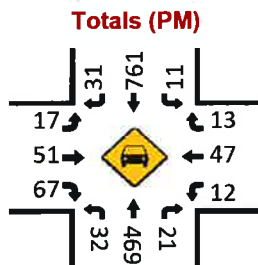
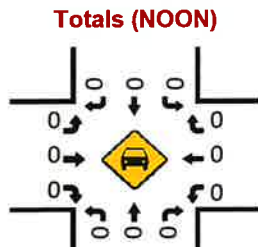
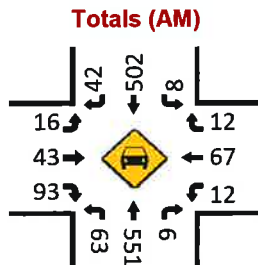
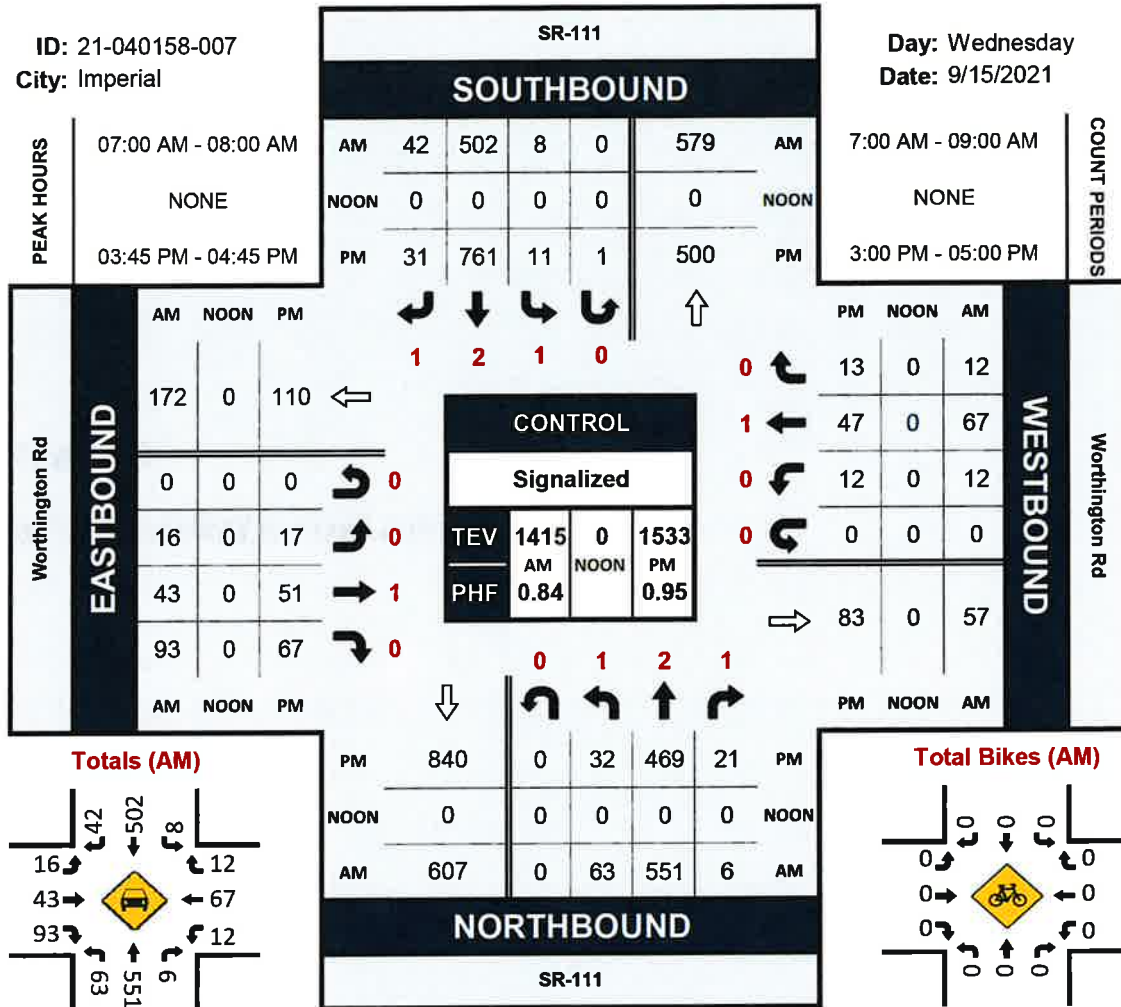













## APPENDIX B

### INTERSECTION ANALYSIS WORKSHEETS – EXISTING

HCM 6th Signalized Intersection Summary  
1: SR-86 & W Keystone Rd

Existing AM  
03/30/2023

												
Movement	EBL	EBT	EBR	WBL	WBT	WBR	NBL	NBT	NBR	SBL	SBT	SBR
Lane Configurations		↔			↔		↗	↕	↗	↗	↕	↗
Traffic Volume (veh/h)	51	42	15	27	38	45	23	456	53	40	467	32
Future Volume (veh/h)	51	42	15	27	38	45	23	456	53	40	467	32
Initial Q (Qb), veh	0	0	0	0	0	0	0	0	0	0	0	0
Ped-Bike Adj(A_pbT)	1.00		1.00	1.00		1.00	1.00		1.00	1.00		1.00
Parking Bus, Adj	1.00	1.00	1.00	1.00	1.00	1.00	1.00	1.00	1.00	1.00	1.00	1.00
Work Zone On Approach		No			No			No			No	
Adj Sat Flow, veh/h/ln	1752	1752	1752	1752	1752	1752	1752	1752	1752	1752	1752	1752
Adj Flow Rate, veh/h	59	48	17	54	69	82	29	570	66	54	631	43
Peak Hour Factor	0.87	0.87	0.87	0.50	0.55	0.55	0.80	0.80	0.80	0.74	0.74	0.74
Percent Heavy Veh, %	10	10	10	10	10	10	10	10	10	10	10	10
Cap, veh/h	198	139	38	135	115	112	87	1095	488	136	1193	532
Arrive On Green	0.18	0.18	0.18	0.18	0.18	0.18	0.05	0.33	0.33	0.08	0.36	0.36
Sat Flow, veh/h	561	768	211	294	637	621	1668	3328	1485	1668	3328	1485
Grp Volume(v), veh/h	124	0	0	205	0	0	29	570	66	54	631	43
Grp Sat Flow(s),veh/h/ln	1541	0	0	1551	0	0	1668	1664	1485	1668	1664	1485
Q Serve(g_s), s	0.0	0.0	0.0	3.1	0.0	0.0	0.9	7.7	1.7	1.7	8.3	1.1
Cycle Q Clear(g_c), s	3.7	0.0	0.0	6.7	0.0	0.0	0.9	7.7	1.7	1.7	8.3	1.1
Prop In Lane	0.48		0.14	0.26		0.40	1.00		1.00	1.00		1.00
Lane Grp Cap(c), veh/h	375	0	0	363	0	0	87	1095	488	136	1193	532
V/C Ratio(X)	0.33	0.00	0.00	0.56	0.00	0.00	0.33	0.52	0.14	0.40	0.53	0.08
Avail Cap(c_a), veh/h	1161	0	0	1210	0	0	250	1895	845	284	1962	875
HCM Platoon Ratio	1.00	1.00	1.00	1.00	1.00	1.00	1.00	1.00	1.00	1.00	1.00	1.00
Upstream Filter(I)	1.00	0.00	0.00	1.00	0.00	0.00	1.00	1.00	1.00	1.00	1.00	1.00
Uniform Delay (d), s/veh	20.0	0.0	0.0	21.2	0.0	0.0	25.3	15.0	13.0	24.1	14.0	11.7
Incr Delay (d2), s/veh	0.5	0.0	0.0	1.4	0.0	0.0	0.8	1.4	0.5	0.7	1.3	0.2
Initial Q Delay(d3),s/veh	0.0	0.0	0.0	0.0	0.0	0.0	0.0	0.0	0.0	0.0	0.0	0.0
%ile BackOfQ(50%),veh/ln	1.4	0.0	0.0	2.4	0.0	0.0	0.3	2.5	0.5	0.6	2.7	0.3
Unsig. Movement Delay, s/veh												
LnGrp Delay(d),s/veh	20.5	0.0	0.0	22.6	0.0	0.0	26.1	16.4	13.5	24.8	15.4	12.0
LnGrp LOS	C	A	A	C	A	A	C	B	B	C	B	B
Approach Vol, veh/h		124			205			665			728	
Approach Delay, s/veh		20.5			22.6			16.6			15.9	
Approach LOS		C			C			B			B	
Timer - Assigned Phs	1	2		4	5	6		8				
Phs Duration (G+Y+Rc), s	10.2	26.6		18.5	8.6	28.2		18.5				
Change Period (Y+Rc), s	* 5.7	* 8.4		8.5	* 5.7	* 8.4		8.5				
Max Green Setting (Gmax), s	* 9.4	* 32		41.5	* 8.3	* 33		41.5				
Max Q Clear Time (g_c+I1), s	3.7	9.7		5.7	2.9	10.3		8.7				
Green Ext Time (p_c), s	0.0	8.5		0.8	0.0	9.3		1.3				
<b>Intersection Summary</b>												
HCM 6th Ctrl Delay				17.3								
HCM 6th LOS				B								
<b>Notes</b>												
* HCM 6th computational engine requires equal clearance times for the phases crossing the barrier.												



**Intersection**

Intersection Delay, s/veh 8.8  
Intersection LOS A

Movement	EBL	EBT	EBR	WBL	WBT	WBR	NBL	NBT	NBR	SBL	SBT	SBR
Lane Configurations		↕			↕			↕			↕	
Traffic Vol, veh/h	19	39	11	3	40	13	23	87	4	10	136	19
Future Vol, veh/h	19	39	11	3	40	13	23	87	4	10	136	19
Peak Hour Factor	0.86	0.86	0.86	0.67	0.67	0.67	0.86	0.86	0.86	0.86	0.86	0.86
Heavy Vehicles, %	10	10	10	10	10	10	10	10	10	10	10	10
Mvmt Flow	22	45	13	4	60	19	27	101	5	12	158	22
Number of Lanes	0	1	0	0	1	0	0	1	0	0	1	0

Approach	EB	WB	NB	SB
Opposing Approach	WB	EB	SB	NB
Opposing Lanes	1	1	1	1
Conflicting Approach Left	SB	NB	EB	WB
Conflicting Lanes Left	1	1	1	1
Conflicting Approach Right	NB	SB	WB	EB
Conflicting Lanes Right	1	1	1	1
HCM Control Delay	8.5	8.5	8.7	9.1
HCM LOS	A	A	A	A

Lane	NBLn1	EBLn1	WBLn1	SBLn1
Vol Left, %	20%	28%	5%	6%
Vol Thru, %	76%	57%	71%	82%
Vol Right, %	4%	16%	23%	12%
Sign Control	Stop	Stop	Stop	Stop
Traffic Vol by Lane	114	69	56	165
LT Vol	23	19	3	10
Through Vol	87	39	40	136
RT Vol	4	11	13	19
Lane Flow Rate	133	80	84	192
Geometry Grp	1	1	1	1
Degree of Util (X)	0.174	0.109	0.112	0.244
Departure Headway (Hd)	4.713	4.9	4.809	4.574
Convergence, Y/N	Yes	Yes	Yes	Yes
Cap	761	730	744	785
Service Time	2.745	2.939	2.847	2.602
HCM Lane V/C Ratio	0.175	0.11	0.113	0.245
HCM Control Delay	8.7	8.5	8.5	9.1
HCM Lane LOS	A	A	A	A
HCM 95th-tile Q	0.6	0.4	0.4	1



HCM 6th Signalized Intersection Summary  
 3: Hwy 111 & E Keystone Rd

Existing AM  
 03/30/2023



Movement	EBL	EBT	EBR	WBL	WBT	WBR	NBL	NBT	NBR	SBL	SBT	SBR
Lane Configurations		↕			↕		↗	↗	↗	↗	↗	↗
Traffic Volume (veh/h)	13	9	46	0	7	1	57	557	2	2	573	3
Future Volume (veh/h)	13	9	46	0	7	1	57	557	2	2	573	3
Initial Q (Qb), veh	0	0	0	0	0	0	0	0	0	0	0	0
Ped-Bike Adj(A_pbT)	1.00		1.00	1.00		1.00	1.00		1.00	1.00		1.00
Parking Bus, Adj	1.00	1.00	1.00	1.00	1.00	1.00	1.00	1.00	1.00	1.00	1.00	1.00
Work Zone On Approach		No			No			No			No	
Adj Sat Flow, veh/h/ln	1752	1752	1752	1752	1752	1752	1752	1752	1752	1752	1752	1752
Adj Flow Rate, veh/h	16	11	56	0	12	2	63	619	2	2	682	4
Peak Hour Factor	0.82	0.82	0.82	0.58	0.58	0.58	0.90	0.90	0.90	0.84	0.84	0.84
Percent Heavy Veh, %	10	10	10	10	10	10	10	10	10	10	10	10
Cap, veh/h	110	56	166	0	237	40	194	1346	600	9	978	436
Arrive On Green	0.16	0.16	0.16	0.00	0.16	0.16	0.12	0.40	0.40	0.01	0.29	0.29
Sat Flow, veh/h	151	343	1023	0	1464	244	1668	3328	1485	1668	3328	1485
Grp Volume(v), veh/h	83	0	0	0	0	14	63	619	2	2	682	4
Grp Sat Flow(s),veh/h/ln	1517	0	0	0	0	1708	1668	1664	1485	1668	1664	1485
Q Serve(g_s), s	0.0	0.0	0.0	0.0	0.0	0.3	1.8	6.9	0.0	0.1	9.2	0.1
Cycle Q Clear(g_c), s	2.4	0.0	0.0	0.0	0.0	0.3	1.8	6.9	0.0	0.1	9.2	0.1
Prop In Lane	0.19		0.67	0.00		0.14	1.00		1.00	1.00		1.00
Lane Grp Cap(c), veh/h	331	0	0	0	0	277	194	1346	600	9	978	436
V/C Ratio(X)	0.25	0.00	0.00	0.00	0.00	0.05	0.32	0.46	0.00	0.22	0.70	0.01
Avail Cap(c_a), veh/h	1584	0	0	0	0	1726	331	1807	806	331	1807	806
HCM Platoon Ratio	1.00	1.00	1.00	1.00	1.00	1.00	1.00	1.00	1.00	1.00	1.00	1.00
Upstream Filter(I)	1.00	0.00	0.00	0.00	0.00	1.00	1.00	1.00	1.00	1.00	1.00	1.00
Uniform Delay (d), s/veh	18.7	0.0	0.0	0.0	0.0	17.9	20.5	11.0	9.0	25.0	15.8	12.6
Incr Delay (d2), s/veh	0.4	0.0	0.0	0.0	0.0	0.1	1.0	0.2	0.0	11.5	0.9	0.0
Initial Q Delay(d3),s/veh	0.0	0.0	0.0	0.0	0.0	0.0	0.0	0.0	0.0	0.0	0.0	0.0
%ile BackOfQ(50%),veh/ln	0.8	0.0	0.0	0.0	0.0	0.1	0.6	1.7	0.0	0.0	2.6	0.0
Unsig. Movement Delay, s/veh												
LnGrp Delay(d),s/veh	19.1	0.0	0.0	0.0	0.0	17.9	21.4	11.2	9.0	36.5	16.7	12.6
LnGrp LOS	B	A	A	A	A	B	C	B	A	D	B	B
Approach Vol, veh/h	83							684			688	
Approach Delay, s/veh	19.1				17.9			12.2			16.8	
Approach LOS	B				B			B			B	
Timer - Assigned Phs	1	2		4	5	6		8				
Phs Duration (G+Y+Rc), s	6.0	28.8		15.7	11.6	23.2		15.7				
Change Period (Y+Rc), s	5.7	* 8.4		7.5	* 5.7	* 8.4		7.5				
Max Green Setting (Gmax), s	27	* 27		51.0	* 10	* 27		51.0				
Max Q Clear Time (g_c+I_Q), s	8.9			4.4	3.8	11.2		2.3				
Green Ext Time (p_c), s	0.0	3.4		0.5	0.0	3.6		0.0				

Intersection Summary												
HCM 6th Ctrl Delay											14.8	
HCM 6th LOS											B	

Notes

\* HCM 6th computational engine requires equal clearance times for the phases crossing the barrier.

**Intersection**

Int Delay, s/veh 0

Movement	WBL	WBR	NBT	NBR	SBL	SBT
Lane Configurations		↗	↗↗			↗↗
Traffic Vol, veh/h	0	0	532	0	0	509
Future Vol, veh/h	0	0	532	0	0	509
Conflicting Peds, #/hr	0	0	0	0	0	0
Sign Control	Stop	Stop	Free	Free	Free	Free
RT Channelized	-	None	-	None	-	None
Storage Length	-	0	-	-	-	-
Veh in Median Storage, #	0	-	0	-	-	0
Grade, %	0	-	0	-	-	0
Peak Hour Factor	92	92	92	92	92	92
Heavy Vehicles, %	10	10	10	10	10	10
Mvmt Flow	0	0	578	0	0	553

Major/Minor	Minor1	Major1	Major2
Conflicting Flow All	-	289	0
Stage 1	-	-	-
Stage 2	-	-	-
Critical Hdwy	-	7.1	-
Critical Hdwy Stg 1	-	-	-
Critical Hdwy Stg 2	-	-	-
Follow-up Hdwy	-	3.4	-
Pot Cap-1 Maneuver	0	684	0
Stage 1	0	-	0
Stage 2	0	-	0
Platoon blocked, %			
Mov Cap-1 Maneuver	-	684	-
Mov Cap-2 Maneuver	-	-	-
Stage 1	-	-	-
Stage 2	-	-	-

Approach	WB	NB	SB
HCM Control Delay, s	0	0	0
HCM LOS	A		

Minor Lane/Major Mvmt	NBTWBLn1	SBT
Capacity (veh/h)	-	-
HCM Lane V/C Ratio	-	-
HCM Control Delay (s)	-	0
HCM Lane LOS	-	A
HCM 95th %tile Q(veh)	-	-



Intersection						
Int Delay, s/veh	0					
Movement	WBL	WBR	NBT	NBR	SBL	SBT
Lane Configurations		↗	↕			↕
Traffic Vol, veh/h	0	0	532	0	0	509
Future Vol, veh/h	0	0	532	0	0	509
Conflicting Peds, #/hr	0	0	0	0	0	0
Sign Control	Stop	Stop	Free	Free	Free	Free
RT Channelized	-	None	-	None	-	None
Storage Length	-	0	-	-	-	-
Veh in Median Storage, #	0	-	0	-	-	0
Grade, %	0	-	0	-	-	0
Peak Hour Factor	92	92	92	92	92	92
Heavy Vehicles, %	10	10	10	10	10	10
Mvmt Flow	0	0	578	0	0	553

Major/Minor	Minor1	Major1	Major2		
Conflicting Flow All	-	289	0	0	-
Stage 1	-	-	-	-	-
Stage 2	-	-	-	-	-
Critical Hdwy	-	7.1	-	-	-
Critical Hdwy Stg 1	-	-	-	-	-
Critical Hdwy Stg 2	-	-	-	-	-
Follow-up Hdwy	-	3.4	-	-	-
Pot Cap-1 Maneuver	0	684	-	-	0
Stage 1	0	-	-	-	0
Stage 2	0	-	-	-	0
Platoon blocked, %			-	-	-
Mov Cap-1 Maneuver	-	684	-	-	-
Mov Cap-2 Maneuver	-	-	-	-	-
Stage 1	-	-	-	-	-
Stage 2	-	-	-	-	-

Approach	WB	NB	SB
HCM Control Delay, s	0	0	0
HCM LOS	A		

Minor Lane/Major Mvmt	NBT	NBRWBLn1	SBT
Capacity (veh/h)	-	-	-
HCM Lane V/C Ratio	-	-	-
HCM Control Delay (s)	-	-	0
HCM Lane LOS	-	-	A
HCM 95th %tile Q(veh)	-	-	-

Intersection												
Int Delay, s/veh	0.4											
Movement	EBL	EBT	EBR	WBL	WBT	WBR	NBL	NBT	NBR	SBL	SBT	SBR
Lane Configurations		↕			↕			↕			↕	
Traffic Vol, veh/h	0	0	0	2	0	17	0	560	4	6	510	0
Future Vol, veh/h	0	0	0	2	0	17	0	560	4	6	510	0
Conflicting Peds, #/hr	0	0	0	0	0	0	0	0	0	0	0	0
Sign Control	Stop	Stop	Stop	Stop	Stop	Stop	Free	Free	Free	Free	Free	Free
RT Channelized	-	-	None	-	-	None	-	-	None	-	-	None
Storage Length	-	-	-	-	-	-	-	-	-	-	-	-
Veh in Median Storage, #	-	0	-	-	0	-	-	0	-	-	0	-
Grade, %	-	0	-	-	0	-	-	0	-	-	0	-
Peak Hour Factor	92	92	92	68	68	68	83	83	83	80	80	80
Heavy Vehicles, %	10	10	10	10	10	10	10	10	10	10	10	10
Mvmt Flow	0	0	0	3	0	25	0	675	5	8	638	0

Major/Minor	Minor2		Minor1		Major1		Major2					
Conflicting Flow All	992	1334	319	1013	1332	340	638	0	0	680	0	0
Stage 1	654	654	-	678	678	-	-	-	-	-	-	-
Stage 2	338	680	-	335	654	-	-	-	-	-	-	-
Critical Hdwy	7.7	6.7	7.1	7.7	6.7	7.1	4.3	-	-	4.3	-	-
Critical Hdwy Stg 1	6.7	5.7	-	6.7	5.7	-	-	-	-	-	-	-
Critical Hdwy Stg 2	6.7	5.7	-	6.7	5.7	-	-	-	-	-	-	-
Follow-up Hdwy	3.6	4.1	3.4	3.6	4.1	3.4	2.3	-	-	2.3	-	-
Pot Cap-1 Maneuver	189	143	654	182	143	633	889	-	-	857	-	-
Stage 1	403	442	-	390	431	-	-	-	-	-	-	-
Stage 2	628	430	-	631	442	-	-	-	-	-	-	-
Platoon blocked, %								-	-	-	-	-
Mov Cap-1 Maneuver	180	141	654	180	141	633	889	-	-	857	-	-
Mov Cap-2 Maneuver	180	141	-	180	141	-	-	-	-	-	-	-
Stage 1	403	436	-	390	431	-	-	-	-	-	-	-
Stage 2	603	430	-	622	436	-	-	-	-	-	-	-

Approach	EB	WB	NB	SB
HCM Control Delay, s	0	12.6	0	0.2
HCM LOS	A	B		

Minor Lane/Major Mvmt	NBL	NBT	NBR	EBLn1	WBLn1	SBL	SBT	SBR
Capacity (veh/h)	889	-	-	-	500	857	-	-
HCM Lane V/C Ratio	-	-	-	-	0.056	0.009	-	-
HCM Control Delay (s)	0	-	-	0	12.6	9.2	0.1	-
HCM Lane LOS	A	-	-	A	B	A	A	-
HCM 95th %tile Q(veh)	0	-	-	-	0.2	0	-	-



Intersection												
Int Delay, s/veh	1.6											
Movement	EBL	EBT	EBR	WBL	WBT	WBR	NBL	NBT	NBR	SBL	SBT	SBR
Lane Configurations		↕			↕			↕			↕	
Traffic Vol, veh/h	4	5	3	3	19	6	3	151	2	1	201	2
Future Vol, veh/h	4	5	3	3	19	6	3	151	2	1	201	2
Conflicting Peds, #/hr	0	0	0	0	0	0	0	0	0	0	0	0
Sign Control	Stop	Stop	Stop	Stop	Stop	Stop	Free	Free	Free	Free	Free	Free
RT Channelized	-	-	None	-	-	None	-	-	None	-	-	None
Storage Length	-	-	-	-	-	-	-	-	-	-	-	-
Veh in Median Storage, #	-	0	-	-	0	-	-	0	-	-	0	-
Grade, %	-	0	-	-	0	-	-	0	-	-	0	-
Peak Hour Factor	60	60	60	64	64	64	76	76	76	76	76	76
Heavy Vehicles, %	10	10	10	10	10	10	10	10	10	10	10	10
Mvmt Flow	7	8	5	5	30	9	4	199	3	1	264	3

Major/Minor	Minor2		Minor1		Major1		Major2					
Conflicting Flow All	496	478	266	483	478	201	267	0	0	202	0	0
Stage 1	268	268	-	209	209	-	-	-	-	-	-	-
Stage 2	228	210	-	274	269	-	-	-	-	-	-	-
Critical Hdwy	7.2	6.6	6.3	7.2	6.6	6.3	4.2	-	-	4.2	-	-
Critical Hdwy Stg 1	6.2	5.6	-	6.2	5.6	-	-	-	-	-	-	-
Critical Hdwy Stg 2	6.2	5.6	-	6.2	5.6	-	-	-	-	-	-	-
Follow-up Hdwy	3.59	4.09	3.39	3.59	4.09	3.39	2.29	-	-	2.29	-	-
Pot Cap-1 Maneuver	471	475	754	481	475	820	1252	-	-	1323	-	-
Stage 1	720	673	-	775	714	-	-	-	-	-	-	-
Stage 2	757	714	-	715	672	-	-	-	-	-	-	-
Platoon blocked, %								-	-	-	-	-
Mov Cap-1 Maneuver	442	473	754	469	473	820	1252	-	-	1323	-	-
Mov Cap-2 Maneuver	442	473	-	469	473	-	-	-	-	-	-	-
Stage 1	717	672	-	772	711	-	-	-	-	-	-	-
Stage 2	714	711	-	701	671	-	-	-	-	-	-	-

Approach	EB	WB	NB	SB
HCM Control Delay, s	12.4	12.6	0.2	0
HCM LOS	B	B		

Minor Lane/Major Mvmt	NBL	NBT	NBR	EBLn1	WBLn1	SBL	SBT	SBR
Capacity (veh/h)	1252	-	-	508	520	1323	-	-
HCM Lane V/C Ratio	0.003	-	-	0.039	0.084	0.001	-	-
HCM Control Delay (s)	7.9	0	-	12.4	12.6	7.7	0	-
HCM Lane LOS	A	A	-	B	B	A	A	-
HCM 95th %tile Q(veh)	0	-	-	0.1	0.3	0	-	-



Intersection												
Int Delay, s/veh	1.4											
Movement	EBL	EBT	EBR	WBL	WBT	WBR	NBL	NBT	NBR	SBL	SBT	SBR
Lane Configurations		↕			↕		↗	↕	↗	↗	↗	↗
Traffic Vol, veh/h	5	5	2	3	7	2	25	552	2	1	559	3
Future Vol, veh/h	5	5	2	3	7	2	25	552	2	1	559	3
Conflicting Peds, #/hr	0	0	0	0	0	0	0	0	0	0	0	0
Sign Control	Stop	Stop	Stop	Stop	Stop	Stop	Free	Free	Free	Free	Free	Free
RT Channelized	-	-	None	-	-	None	-	-	Free	-	-	Free
Storage Length	-	-	-	-	-	-	515	-	515	520	-	480
Veh in Median Storage, #	-	0	-	-	0	-	-	0	-	-	0	-
Grade, %	-	0	-	-	0	-	-	0	-	-	0	-
Peak Hour Factor	50	50	50	42	42	42	86	86	86	88	88	88
Heavy Vehicles, %	10	10	10	10	10	10	10	10	10	10	10	10
Mvmt Flow	10	10	4	7	17	5	29	642	2	1	635	3

Major/Minor	Minor2		Minor1		Major1			Major2				
Conflicting Flow All	1025	1337	318	1025	1337	321	635	0	-	642	0	0
Stage 1	637	637	-	700	700	-	-	-	-	-	-	-
Stage 2	388	700	-	325	637	-	-	-	-	-	-	-
Critical Hdwy	7.7	6.7	7.1	7.7	6.7	7.1	4.3	-	-	4.3	-	-
Critical Hdwy Stg 1	6.7	5.7	-	6.7	5.7	-	-	-	-	-	-	-
Critical Hdwy Stg 2	6.7	5.7	-	6.7	5.7	-	-	-	-	-	-	-
Follow-up Hdwy	3.6	4.1	3.4	3.6	4.1	3.4	2.3	-	-	2.3	-	-
Pot Cap-1 Maneuver	178	142	655	178	142	652	892	-	0	886	-	0
Stage 1	413	450	-	378	421	-	-	-	0	-	-	0
Stage 2	586	421	-	640	450	-	-	-	0	-	-	0
Platoon blocked, %								-			-	
Mov Cap-1 Maneuver	156	137	655	163	137	652	892	-	-	886	-	-
Mov Cap-2 Maneuver	156	137	-	163	137	-	-	-	-	-	-	-
Stage 1	399	450	-	366	407	-	-	-	-	-	-	-
Stage 2	540	407	-	621	450	-	-	-	-	-	-	-

Approach	EB	WB	NB	SB
HCM Control Delay, s	30	31.3	0.4	0
HCM LOS	D	D		

Minor Lane/Major Mvmt	NBL	NBT	EBLn1	WBLn1	SBL	SBT
Capacity (veh/h)	892	-	168	165	886	-
HCM Lane V/C Ratio	0.033	-	0.143	0.173	0.001	-
HCM Control Delay (s)	9.2	-	30	31.3	9.1	-
HCM Lane LOS	A	-	D	D	A	-
HCM 95th %tile Q(veh)	0.1	-	0.5	0.6	0	-

HCM 6th Signalized Intersection Summary  
 9: SR-86 & Worthington Rd/E Barioni Blvd

Existing AM  
 03/30/2023



Movement	EBL	EBT	EBR	WBL	WBT	WBR	NBL	NBT	NBR	SBL	SBT	SBR
Lane Configurations		↕	↗		↕	↗	↖	↕↗		↖	↕↗	
Traffic Volume (veh/h)	82	113	233	119	80	43	131	681	72	51	786	41
Future Volume (veh/h)	82	113	233	119	80	43	131	681	72	51	786	41
Initial Q (Qb), veh	0	0	0	0	0	0	0	0	0	0	0	0
Ped-Bike Adj(A_pbT)	1.00		1.00	1.00		0.99	1.00		1.00	1.00		1.00
Parking Bus, Adj	1.00	1.00	1.00	1.00	1.00	1.00	1.00	1.00	1.00	1.00	1.00	1.00
Work Zone On Approach		No			No			No			No	
Adj Sat Flow, veh/h/ln	1752	1752	1752	1752	1752	1752	1752	1752	1752	1752	1752	1752
Adj Flow Rate, veh/h	94	130	268	142	95	51	158	820	87	61	936	49
Peak Hour Factor	0.87	0.87	0.87	0.84	0.84	0.84	0.83	0.83	0.83	0.84	0.84	0.84
Percent Heavy Veh, %	10	10	10	10	10	10	10	10	10	10	10	10
Cap, veh/h	146	203	301	170	114	247	182	1131	120	76	995	52
Arrive On Green	0.20	0.20	0.20	0.17	0.17	0.17	0.11	0.37	0.37	0.05	0.31	0.31
Sat Flow, veh/h	720	996	1478	1019	682	1477	1668	3035	322	1668	3217	168
Grp Volume(v), veh/h	224	0	268	237	0	51	158	450	457	61	484	501
Grp Sat Flow(s),veh/h/ln	1716	0	1478	1701	0	1477	1668	1664	1693	1668	1664	1721
Q Serve(g_s), s	10.2	0.0	15.0	11.5	0.0	2.5	7.9	19.8	19.8	3.1	24.2	24.2
Cycle Q Clear(g_c), s	10.2	0.0	15.0	11.5	0.0	2.5	7.9	19.8	19.8	3.1	24.2	24.2
Prop In Lane	0.42		1.00	0.60		1.00	1.00		0.19	1.00		0.10
Lane Grp Cap(c), veh/h	349	0	301	284	0	247	182	620	631	76	515	532
V/C Ratio(X)	0.64	0.00	0.89	0.83	0.00	0.21	0.87	0.72	0.72	0.80	0.94	0.94
Avail Cap(c_a), veh/h	364	0	314	361	0	314	182	620	631	112	517	535
HCM Platoon Ratio	1.00	1.00	1.00	1.00	1.00	1.00	1.00	1.00	1.00	1.00	1.00	1.00
Upstream Filter(I)	1.00	0.00	1.00	1.00	0.00	1.00	1.00	1.00	1.00	1.00	1.00	1.00
Uniform Delay (d), s/veh	31.1	0.0	33.0	34.4	0.0	30.6	37.4	23.0	23.0	40.3	28.7	28.7
Incr Delay (d2), s/veh	3.6	0.0	25.0	12.6	0.0	0.4	33.1	4.2	4.1	22.1	25.5	25.0
Initial Q Delay(d3),s/veh	0.0	0.0	0.0	0.0	0.0	0.0	0.0	0.0	0.0	0.0	0.0	0.0
%ile BackOfQ(50%),veh/ln	4.5	0.0	7.3	5.6	0.0	0.9	4.7	7.7	7.8	1.7	12.4	12.7
Unsig. Movement Delay, s/veh												
LnGrp Delay(d),s/veh	34.7	0.0	58.1	47.0	0.0	31.0	70.5	27.2	27.1	62.4	54.2	53.6
LnGrp LOS	C	A	E	D	A	C	E	C	C	E	D	D
Approach Vol, veh/h		492			288			1065			1046	
Approach Delay, s/veh		47.4			44.1			33.6			54.4	
Approach LOS		D			D			C			D	
Timer - Assigned Phs	1	2		4	5	6		8				
Phs Duration (G+Y+Rc), s	8.4	36.3		21.8	13.8	30.9		18.7				
Change Period (Y+Rc), s	4.5	4.5		4.5	4.5	4.5		4.5				
Max Green Setting (Gmax), s	5.7	30.1		18.1	9.3	26.5		18.1				
Max Q Clear Time (g_c+I1), s	5.1	21.8		17.0	9.9	26.2		13.5				
Green Ext Time (p_c), s	0.0	3.3		0.3	0.0	0.2		0.6				

Intersection Summary		
HCM 6th Ctrl Delay		44.5
HCM 6th LOS		D

Notes  
 User approved pedestrian interval to be less than phase max green.



Intersection

Intersection Delay, s/veh 12.9

Intersection LOS B

Movement	EBL	EBT	EBR	WBL	WBT	WBR	NBL	NBT	NBR	SBL	SBT	SBR
Lane Configurations		↕			↕			↕			↕	
Traffic Vol, veh/h	12	141	57	3	123	12	46	133	7	34	196	21
Future Vol, veh/h	12	141	57	3	123	12	46	133	7	34	196	21
Peak Hour Factor	0.86	0.86	0.86	0.73	0.73	0.73	0.93	0.93	0.93	0.80	0.80	0.80
Heavy Vehicles, %	10	10	10	10	10	10	10	10	10	10	10	10
Mvmt Flow	14	164	66	4	168	16	49	143	8	43	245	26
Number of Lanes	0	1	0	0	1	0	0	1	0	0	1	0

Approach	EB	WB	NB	SB
Opposing Approach	WB	EB	SB	NB
Opposing Lanes	1	1	1	1
Conflicting Approach Left	SB	NB	EB	WB
Conflicting Lanes Left	1	1	1	1
Conflicting Approach Right	NB	SB	WB	EB
Conflicting Lanes Right	1	1	1	1
HCM Control Delay	12.6	11.8	12	14.3
HCM LOS	B	B	B	B

Lane	NBLn1	EBLn1	WBLn1	SBLn1
Vol Left, %	25%	6%	2%	14%
Vol Thru, %	72%	67%	89%	78%
Vol Right, %	4%	27%	9%	8%
Sign Control	Stop	Stop	Stop	Stop
Traffic Vol by Lane	186	210	138	251
LT Vol	46	12	3	34
Through Vol	133	141	123	196
RT Vol	7	57	12	21
Lane Flow Rate	200	244	189	314
Geometry Grp	1	1	1	1
Degree of Util (X)	0.331	0.392	0.314	0.497
Departure Headway (Hd)	5.951	5.782	5.987	5.7
Convergence, Y/N	Yes	Yes	Yes	Yes
Cap	600	618	597	631
Service Time	4.025	3.853	4.064	3.765
HCM Lane V/C Ratio	0.333	0.395	0.317	0.498
HCM Control Delay	12	12.6	11.8	14.3
HCM Lane LOS	B	B	B	B
HCM 95th-tile Q	1.4	1.9	1.3	2.8

HCM 6th Signalized Intersection Summary  
 11: Hwy 111 & E. Worthington Rd

Existing AM  
 03/30/2023



Movement	EBL	EBT	EBR	WBL	WBT	WBR	NBL	NBT	NBR	SBL	SBT	SBR
Lane Configurations		↕			↕		↗	↗	↗	↗	↗	↗
Traffic Volume (veh/h)	16	43	93	12	67	12	63	551	6	8	502	42
Future Volume (veh/h)	16	43	93	12	67	12	63	551	6	8	502	42
Initial Q (Qb), veh	0	0	0	0	0	0	0	0	0	0	0	0
Ped-Bike Adj(A_pbT)	1.00		1.00	1.00		1.00	1.00		1.00	1.00		1.00
Parking Bus, Adj	1.00	1.00	1.00	1.00	1.00	1.00	1.00	1.00	1.00	1.00	1.00	1.00
Work Zone On Approach		No			No			No			No	
Adj Sat Flow, veh/h/ln	1870	1870	1870	1870	1870	1870	1870	1870	1870	1870	1870	1870
Adj Flow Rate, veh/h	21	55	119	16	88	16	74	648	0	9	591	0
Peak Hour Factor	0.78	0.78	0.78	0.76	0.76	0.76	0.85	0.85	0.85	0.85	0.85	0.85
Percent Heavy Veh, %	2	2	2	2	2	2	2	2	2	2	2	2
Cap, veh/h	91	100	183	96	260	43	265	1329		50	901	
Arrive On Green	0.18	0.18	0.18	0.18	0.18	0.18	0.15	0.37	0.00	0.03	0.25	0.00
Sat Flow, veh/h	94	547	1005	115	1428	237	1781	3554	1585	1781	3554	1585
Grp Volume(v), veh/h	195	0	0	120	0	0	74	648	0	9	591	0
Grp Sat Flow(s),veh/h/ln1647	0	0	0	1780	0	0	1781	1777	1585	1781	1777	1585
Q Serve(g_s), s	1.4	0.0	0.0	0.0	0.0	0.0	2.0	7.6	0.0	0.3	8.1	0.0
Cycle Q Clear(g_c), s	5.9	0.0	0.0	3.1	0.0	0.0	2.0	7.6	0.0	0.3	8.1	0.0
Prop In Lane	0.11		0.61	0.13		0.13	1.00		1.00	1.00		1.00
Lane Grp Cap(c), veh/h	374	0	0	400	0	0	265	1329		50	901	
V/C Ratio(X)	0.52	0.00	0.00	0.30	0.00	0.00	0.28	0.49		0.18	0.66	
Avail Cap(c_a), veh/h	495	0	0	528	0	0	393	1329		393	1072	
HCM Platoon Ratio	1.00	1.00	1.00	1.00	1.00	1.00	1.00	1.00	1.00	1.00	1.00	1.00
Upstream Filter(I)	1.00	0.00	0.00	1.00	0.00	0.00	1.00	1.00	0.00	1.00	1.00	0.00
Uniform Delay (d), s/veh	20.6	0.0	0.0	19.5	0.0	0.0	20.6	13.0	0.0	25.8	18.2	0.0
Incr Delay (d2), s/veh	1.4	0.0	0.0	1.9	0.0	0.0	0.2	1.3	0.0	0.6	3.7	0.0
Initial Q Delay(d3),s/veh	0.0	0.0	0.0	0.0	0.0	0.0	0.0	0.0	0.0	0.0	0.0	0.0
%ile BackOfQ(50%),veh/ln2.2	0.0	0.0	0.0	1.4	0.0	0.0	0.7	2.4	0.0	0.1	3.0	0.0
Unsig. Movement Delay, s/veh												
LnGrp Delay(d),s/veh	22.0	0.0	0.0	21.4	0.0	0.0	20.8	14.3	0.0	26.4	21.9	0.0
LnGrp LOS	C	A	A	C	A	A	C	B		C	C	
Approach Vol, veh/h		195			120			722			600	
Approach Delay, s/veh		22.0			21.4			15.0			22.0	
Approach LOS		C			C			B			C	
Timer - Assigned Phs	1	2		4	5	6		8				
Phs Duration (G+Y+Rc), s7.2		28.7		18.4	13.8	22.2		18.4				
Change Period (Y+Rc), s5.7		*8.4		8.5	*5.7	*8.4		8.5				
Max Green Setting (Gmax), s12		*16		14.0	*12	*16		14.0				
Max Q Clear Time (g_c+I), s12,3		9.6		7.9	4.0	10.1		5.1				
Green Ext Time (p_c), s		0.0		4.2	0.6	0.0		3.7				





















Intersection Summary		
HCM 6th Ctrl Delay		18.8
HCM 6th LOS		B

Notes  
 \* HCM 6th computational engine requires equal clearance times for the phases crossing the barrier.  
 Unsignalized Delay for [NBR, SBR] is excluded from calculations of the approach delay and intersection delay.



HCM 6th Signalized Intersection Summary  
1: SR-86 & W Keystone Rd

Existing PM  
03/30/2023

												
Movement	EBL	EBT	EBR	WBL	WBT	WBR	NBL	NBT	NBR	SBL	SBT	SBR
Lane Configurations												
Traffic Volume (veh/h)	34	28	18	80	31	52	23	438	23	32	451	22
Future Volume (veh/h)	34	28	18	80	31	52	23	438	23	32	451	22
Initial Q (Qb), veh	0	0	0	0	0	0	0	0	0	0	0	0
Ped-Bike Adj(A_pbT)	1.00		1.00	1.00		1.00	1.00		1.00	1.00		1.00
Parking Bus, Adj	1.00	1.00	1.00	1.00	1.00	1.00	1.00	1.00	1.00	1.00	1.00	1.00
Work Zone On Approach		No			No			No			No	
Adj Sat Flow, veh/h/ln	1752	1752	1752	1752	1752	1752	1752	1752	1752	1752	1752	1752
Adj Flow Rate, veh/h	44	36	23	138	53	90	25	476	25	37	524	26
Peak Hour Factor	0.77	0.77	0.77	0.58	0.58	0.58	0.92	0.92	0.92	0.86	0.86	0.86
Percent Heavy Veh, %	10	10	10	10	10	10	10	10	10	10	10	10
Cap, veh/h	213	160	81	251	88	115	77	957	427	104	1012	451
Arrive On Green	0.25	0.25	0.25	0.25	0.25	0.25	0.05	0.29	0.29	0.06	0.30	0.30
Sat Flow, veh/h	491	652	329	632	359	467	1668	3328	1485	1668	3328	1485
Grp Volume(v), veh/h	103	0	0	281	0	0	25	476	25	37	524	26
Grp Sat Flow(s),veh/h/ln	1472	0	0	1458	0	0	1668	1664	1485	1668	1664	1485
Q Serve(g_s), s	0.0	0.0	0.0	7.1	0.0	0.0	0.8	6.6	0.7	1.2	7.3	0.7
Cycle Q Clear(g_c), s	2.8	0.0	0.0	9.9	0.0	0.0	0.8	6.6	0.7	1.2	7.3	0.7
Prop In Lane	0.43		0.22	0.49		0.32	1.00		1.00	1.00		1.00
Lane Grp Cap(c), veh/h	453	0	0	454	0	0	77	957	427	104	1012	451
V/C Ratio(X)	0.23	0.00	0.00	0.62	0.00	0.00	0.33	0.50	0.06	0.35	0.52	0.06
Avail Cap(c_a), veh/h	1147	0	0	1151	0	0	248	1942	866	248	1942	866
HCM Platoon Ratio	1.00	1.00	1.00	1.00	1.00	1.00	1.00	1.00	1.00	1.00	1.00	1.00
Upstream Filter(I)	1.00	0.00	0.00	1.00	0.00	0.00	1.00	1.00	1.00	1.00	1.00	1.00
Uniform Delay (d), s/veh	16.9	0.0	0.0	19.5	0.0	0.0	25.8	16.6	14.4	25.1	16.1	13.8
Incr Delay (d2), s/veh	0.3	0.0	0.0	1.4	0.0	0.0	0.9	1.5	0.2	0.8	1.5	0.2
Initial Q Delay(d3),s/veh	0.0	0.0	0.0	0.0	0.0	0.0	0.0	0.0	0.0	0.0	0.0	0.0
%ile BackOfQ(50%),veh/ln	1.0	0.0	0.0	3.2	0.0	0.0	0.3	2.3	0.2	0.4	2.5	0.2
Unsig. Movement Delay, s/veh												
LnGrp Delay(d),s/veh	17.2	0.0	0.0	20.8	0.0	0.0	26.7	18.0	14.6	25.9	17.6	14.0
LnGrp LOS	B	A	A	C	A	A	C	B	B	C	B	B
Approach Vol, veh/h		103			281			526			587	
Approach Delay, s/veh		17.2			20.8			18.3			17.9	
Approach LOS		B			C			B			B	
Timer - Assigned Phs	1	2		4	5	6		8				
Phs Duration (G+Y+Rc), s	9.2	24.5		22.2	8.3	25.4		22.2				
Change Period (Y+Rc), s	* 5.7	* 8.4		8.5	* 5.7	* 8.4		8.5				
Max Green Setting (Gmax), s	* 8.3	* 33		41.5	* 8.3	* 33		41.5				
Max Q Clear Time (g_c+I1), s	3.2	8.6		4.8	2.8	9.3		11.9				
Green Ext Time (p_c), s	0.0	7.1		0.6	0.0	7.7		1.9				
<b>Intersection Summary</b>												
HCM 6th Ctrl Delay				18.5								
HCM 6th LOS				B								
<b>Notes</b>												
* HCM 6th computational engine requires equal clearance times for the phases crossing the barrier.												



**Intersection**

Intersection Delay, s/veh 10.6

Intersection LOS B

Movement	EBL	EBT	EBR	WBL	WBT	WBR	NBL	NBT	NBR	SBL	SBT	SBR
Lane Configurations		↕			↕			↕			↕	
Traffic Vol, veh/h	25	38	13	7	44	9	16	201	3	13	180	30
Future Vol, veh/h	25	38	13	7	44	9	16	201	3	13	180	30
Peak Hour Factor	0.73	0.73	0.73	0.94	0.94	0.94	0.76	0.76	0.76	0.70	0.79	0.79
Heavy Vehicles, %	10	10	10	10	10	10	10	10	10	10	10	10
Mvmt Flow	34	52	18	7	47	10	21	264	4	19	228	38
Number of Lanes	0	1	0	0	1	0	0	1	0	0	1	0

Approach	EB	WB	NB	SB
Opposing Approach	WB	EB	SB	NB
Opposing Lanes	1	1	1	1
Conflicting Approach Left	SB	NB	EB	WB
Conflicting Lanes Left	1	1	1	1
Conflicting Approach Right	NB	SB	WB	EB
Conflicting Lanes Right	1	1	1	1
HCM Control Delay	9.6	9.2	11.1	10.8
HCM LOS	A	A	B	B

Lane	NBLn1	EBLn1	WBLn1	SBLn1
Vol Left, %	7%	33%	12%	6%
Vol Thru, %	91%	50%	73%	81%
Vol Right, %	1%	17%	15%	13%
Sign Control	Stop	Stop	Stop	Stop
Traffic Vol by Lane	220	76	60	223
LT Vol	16	25	7	13
Through Vol	201	38	44	180
RT Vol	3	13	9	30
Lane Flow Rate	289	104	64	284
Geometry Grp	1	1	1	1
Degree of Util (X)	0.392	0.159	0.098	0.38
Departure Headway (Hd)	4.87	5.484	5.525	4.806
Convergence, Y/N	Yes	Yes	Yes	Yes
Cap	735	648	641	742
Service Time	2.935	3.574	3.624	2.871
HCM Lane V/C Ratio	0.393	0.16	0.1	0.383
HCM Control Delay	11.1	9.6	9.2	10.8
HCM Lane LOS	B	A	A	B
HCM 95th-tile Q	1.9	0.6	0.3	1.8

HCM 6th Signalized Intersection Summary  
3: Hwy 111 & E Keystone Rd

Existing PM  
03/30/2023



Movement	EBL	EBT	EBR	WBL	WBT	WBR	NBL	NBT	NBR	SBL	SBT	SBR
Lane Configurations		↕			↕		↗	↗	↗	↗	↗	↗
Traffic Volume (veh/h)	4	3	64	1	7	1	23	512	4	1	826	18
Future Volume (veh/h)	4	3	64	1	7	1	23	512	4	1	826	18
Initial Q (Qb), veh	0	0	0	0	0	0	0	0	0	0	0	0
Ped-Bike Adj(A_pbT)	1.00		1.00	1.00		1.00	1.00		1.00	1.00		1.00
Parking Bus, Adj	1.00	1.00	1.00	1.00	1.00	1.00	1.00	1.00	1.00	1.00	1.00	1.00
Work Zone On Approach		No			No			No			No	
Adj Sat Flow, veh/h/ln	1752	1752	1752	1752	1752	1752	1752	1752	1752	1752	1752	1752
Adj Flow Rate, veh/h	5	4	79	1	10	1	25	557	4	1	879	19
Peak Hour Factor	0.81	0.81	0.81	0.67	0.67	0.67	0.92	0.92	0.92	0.94	0.94	0.94
Percent Heavy Veh, %	10	10	10	10	10	10	10	10	10	10	10	10
Cap, veh/h	80	20	219	83	248	23	97	1376	614	5	1190	531
Arrive On Green	0.16	0.16	0.16	0.16	0.16	0.16	0.06	0.41	0.41	0.00	0.36	0.36
Sat Flow, veh/h	33	120	1345	41	1525	142	1668	3328	1485	1668	3328	1485
Grp Volume(v), veh/h	88	0	0	12	0	0	25	557	4	1	879	19
Grp Sat Flow(s),veh/h/ln	1499	0	0	1709	0	0	1668	1664	1485	1668	1664	1485
Q Serve(g_s), s	0.0	0.0	0.0	0.0	0.0	0.0	0.7	6.0	0.1	0.0	11.8	0.4
Cycle Q Clear(g_c), s	2.7	0.0	0.0	0.3	0.0	0.0	0.7	6.0	0.1	0.0	11.8	0.4
Prop In Lane	0.06		0.90	0.08		0.08	1.00		1.00	1.00		1.00
Lane Grp Cap(c), veh/h	318	0	0	354	0	0	97	1376	614	5	1190	531
V/C Ratio(X)	0.28	0.00	0.00	0.03	0.00	0.00	0.26	0.40	0.01	0.22	0.74	0.04
Avail Cap(c_a), veh/h	1552	0	0	1741	0	0	325	1778	793	325	1778	793
HCM Platoon Ratio	1.00	1.00	1.00	1.00	1.00	1.00	1.00	1.00	1.00	1.00	1.00	1.00
Upstream Filter(I)	1.00	0.00	0.00	1.00	0.00	0.00	1.00	1.00	1.00	1.00	1.00	1.00
Uniform Delay (d), s/veh	19.1	0.0	0.0	18.1	0.0	0.0	23.1	10.6	8.9	25.5	14.4	10.7
Incr Delay (d2), s/veh	0.5	0.0	0.0	0.0	0.0	0.0	1.4	0.2	0.0	22.1	0.9	0.0
Initial Q Delay(d3),s/veh	0.0	0.0	0.0	0.0	0.0	0.0	0.0	0.0	0.0	0.0	0.0	0.0
%ile BackOfQ(50%),veh/ln	0.9	0.0	0.0	0.1	0.0	0.0	0.3	1.5	0.0	0.0	3.2	0.1
Unsig. Movement Delay, s/veh												
LnGrp Delay(d),s/veh	19.6	0.0	0.0	18.1	0.0	0.0	24.5	10.8	8.9	47.6	15.3	10.7
LnGrp LOS	B	A	A	B	A	A	C	B	A	D	B	B
Approach Vol, veh/h		88			12			586			899	
Approach Delay, s/veh		19.6			18.1			11.4			15.2	
Approach LOS		B			B			B			B	
Timer - Assigned Phs	1	2		4	5	6		8				
Phs Duration (G+Y+Rc), s	5.8	29.6		15.9	8.7	26.7		15.9				
Change Period (Y+Rc), s	5.7	* 8.4		7.5	* 5.7	* 8.4		7.5				
Max Green Setting (Gmax), s	30	* 27		51.0	* 10	* 27		51.0				
Max Q Clear Time (g_c+I), s	10	8.0		4.7	2.7	13.8		2.3				
Green Ext Time (p_c), s	0.0	3.1		0.6	0.0	4.5		0.0				

Intersection Summary

HCM 6th Ctrl Delay	14.1
HCM 6th LOS	B

Notes

\* HCM 6th computational engine requires equal clearance times for the phases crossing the barrier.



**Intersection**

Int Delay, s/veh 0

Movement	WBL	WBR	NBT	NBR	SBL	SBT
Lane Configurations		↗	↗↗			↗↗
Traffic Vol, veh/h	0	0	484	0	0	549
Future Vol, veh/h	0	0	484	0	0	549
Conflicting Peds, #/hr	0	0	0	0	0	0
Sign Control	Stop	Stop	Free	Free	Free	Free
RT Channelized	-	None	-	None	-	None
Storage Length	-	0	-	-	-	-
Veh in Median Storage, #	0	-	0	-	-	0
Grade, %	0	-	0	-	-	0
Peak Hour Factor	92	92	92	92	92	92
Heavy Vehicles, %	10	10	10	10	10	10
Mvmt Flow	0	0	526	0	0	597

Major/Minor	Minor1	Major1	Major2	Major3	Major4
Conflicting Flow All	-	263	0	-	-
Stage 1	-	-	-	-	-
Stage 2	-	-	-	-	-
Critical Hdwy	-	7.1	-	-	-
Critical Hdwy Stg 1	-	-	-	-	-
Critical Hdwy Stg 2	-	-	-	-	-
Follow-up Hdwy	-	3.4	-	-	-
Pot Cap-1 Maneuver	0	712	-	0	0
Stage 1	0	-	-	0	0
Stage 2	0	-	-	0	0
Platoon blocked, %			-		-
Mov Cap-1 Maneuver	-	712	-	-	-
Mov Cap-2 Maneuver	-	-	-	-	-
Stage 1	-	-	-	-	-
Stage 2	-	-	-	-	-

Approach	WB	NB	SB
HCM Control Delay, s	0	0	0
HCM LOS	A		

Minor Lane/Major Mvmt	NBTWBLn1	SBT
Capacity (veh/h)	-	-
HCM Lane V/C Ratio	-	-
HCM Control Delay (s)	-	0
HCM Lane LOS	-	A
HCM 95th %tile Q(veh)	-	-

Intersection						
Int Delay, s/veh	0					
Movement	WBL	WBR	NBT	NBR	SBL	SBT
Lane Configurations		↗	↕			↕
Traffic Vol, veh/h	0	0	484	0	0	549
Future Vol, veh/h	0	0	484	0	0	549
Conflicting Peds, #/hr	0	0	0	0	0	0
Sign Control	Stop	Stop	Free	Free	Free	Free
RT Channelized	-	None	-	None	-	None
Storage Length	-	0	-	-	-	-
Veh in Median Storage, #	0	-	0	-	-	0
Grade, %	0	-	0	-	-	0
Peak Hour Factor	92	92	92	92	92	92
Heavy Vehicles, %	10	10	10	10	10	10
Mvmt Flow	0	0	526	0	0	597

Major/Minor	Minor1	Major1	Major2		
Conflicting Flow All	-	263	0	0	-
Stage 1	-	-	-	-	-
Stage 2	-	-	-	-	-
Critical Hdwy	-	7.1	-	-	-
Critical Hdwy Stg 1	-	-	-	-	-
Critical Hdwy Stg 2	-	-	-	-	-
Follow-up Hdwy	-	3.4	-	-	-
Pot Cap-1 Maneuver	0	712	-	-	0
Stage 1	0	-	-	-	0
Stage 2	0	-	-	-	0
Platoon blocked, %					
Mov Cap-1 Maneuver	-	712	-	-	-
Mov Cap-2 Maneuver	-	-	-	-	-
Stage 1	-	-	-	-	-
Stage 2	-	-	-	-	-

Approach	WB	NB	SB
HCM Control Delay, s	0	0	0
HCM LOS	A		

Minor Lane/Major Mvmt	NBT	NBRWBLn1	SBT
Capacity (veh/h)	-	-	-
HCM Lane V/C Ratio	-	-	-
HCM Control Delay (s)	-	-	0
HCM Lane LOS	-	-	A
HCM 95th %tile Q(veh)	-	-	-



Intersection												
Int Delay, s/veh	0.5											
Movement	EBL	EBT	EBR	WBL	WBT	WBR	NBL	NBT	NBR	SBL	SBT	SBR
Lane Configurations		↔			↔			↔			↔	
Traffic Vol, veh/h	0	0	0	6	1	7	0	515	1	13	640	0
Future Vol, veh/h	0	0	0	6	1	7	0	515	1	13	640	0
Conflicting Peds, #/hr	0	0	0	0	0	0	0	0	0	0	0	0
Sign Control	Stop	Stop	Stop	Stop	Stop	Stop	Free	Free	Free	Free	Free	Free
RT Channelized	-	-	None	-	-	None	-	-	None	-	-	None
Storage Length	-	-	-	-	-	-	-	-	-	-	-	-
Veh in Median Storage, #	-	0	-	-	0	-	-	0	-	-	0	-
Grade, %	-	0	-	-	0	-	-	0	-	-	0	-
Peak Hour Factor	92	92	92	58	58	58	93	93	93	82	82	82
Heavy Vehicles, %	10	10	10	10	10	10	10	10	10	10	10	10
Mvmt Flow	0	0	0	10	2	12	0	554	1	16	780	0

Major/Minor	Minor2		Minor1		Major1		Major2					
Conflicting Flow All	1090	1367	390	977	1367	278	780	0	0	555	0	0
Stage 1	812	812	-	555	555	-	-	-	-	-	-	-
Stage 2	278	555	-	422	812	-	-	-	-	-	-	-
Critical Hdwy	7.7	6.7	7.1	7.7	6.7	7.1	4.3	-	-	4.3	-	-
Critical Hdwy Stg 1	6.7	5.7	-	6.7	5.7	-	-	-	-	-	-	-
Critical Hdwy Stg 2	6.7	5.7	-	6.7	5.7	-	-	-	-	-	-	-
Follow-up Hdwy	3.6	4.1	3.4	3.6	4.1	3.4	2.3	-	-	2.3	-	-
Pot Cap-1 Maneuver	160	136	587	194	136	696	783	-	-	958	-	-
Stage 1	322	372	-	464	492	-	-	-	-	-	-	-
Stage 2	683	492	-	559	372	-	-	-	-	-	-	-
Platoon blocked, %								-	-	-	-	-
Mov Cap-1 Maneuver	152	132	587	190	132	696	783	-	-	958	-	-
Mov Cap-2 Maneuver	152	132	-	190	132	-	-	-	-	-	-	-
Stage 1	322	361	-	464	492	-	-	-	-	-	-	-
Stage 2	669	492	-	543	361	-	-	-	-	-	-	-

Approach	EB	WB	NB	SB
HCM Control Delay, s	0	18.9	0	0.3
HCM LOS	A	C		

Minor Lane/Major Mvmt	NBL	NBT	NBR	EBLn1	WBLn1	SBL	SBT	SBR
Capacity (veh/h)	783	-	-	-	284	958	-	-
HCM Lane V/C Ratio	-	-	-	-	0.085	0.017	-	-
HCM Control Delay (s)	0	-	-	0	18.9	8.8	0.1	-
HCM Lane LOS	A	-	-	A	C	A	A	-
HCM 95th %tile Q(veh)	0	-	-	-	0.3	0.1	-	-



**Intersection**

Int Delay, s/veh 1.4

Movement	EBL	EBT	EBR	WBL	WBT	WBR	NBL	NBT	NBR	SBL	SBT	SBR
Lane Configurations		↕			↕			↕			↕	
Traffic Vol, veh/h	2	16	6	4	12	2	2	182	1	4	225	3
Future Vol, veh/h	2	16	6	4	12	2	2	182	1	4	225	3
Conflicting Peds, #/hr	0	0	0	0	0	0	0	0	0	0	0	0
Sign Control	Stop	Stop	Stop	Stop	Stop	Stop	Free	Free	Free	Free	Free	Free
RT Channelized	-	-	None	-	-	None	-	-	None	-	-	None
Storage Length	-	-	-	-	-	-	-	-	-	-	-	-
Veh in Median Storage, #	-	0	-	-	0	-	-	0	-	-	0	-
Grade, %	-	0	-	-	0	-	-	0	-	-	0	-
Peak Hour Factor	67	67	67	75	75	75	76	76	76	78	78	78
Heavy Vehicles, %	10	10	10	10	10	10	10	10	10	10	10	10
Mvmt Flow	3	24	9	5	16	3	3	239	1	5	288	4

Major/Minor	Minor2	Minor1	Major1	Major2
Conflicting Flow All	555	546	290	563
Stage 1	300	300	-	246
Stage 2	255	246	-	317
Critical Hdwy	7.2	6.6	6.3	7.2
Critical Hdwy Stg 1	6.2	5.6	-	6.2
Critical Hdwy Stg 2	6.2	5.6	-	6.2
Follow-up Hdwy	3.59	4.09	3.39	3.59
Pot Cap-1 Maneuver	430	434	731	425
Stage 1	692	651	-	740
Stage 2	732	688	-	678
Platoon blocked, %				
Mov Cap-1 Maneuver	414	431	731	400
Mov Cap-2 Maneuver	414	431	-	400
Stage 1	690	648	-	738
Stage 2	710	686	-	642

Approach	EB	WB	NB	SB
HCM Control Delay, s	13.1	13.6	0.1	0.1
HCM LOS	B	B		

Minor Lane/Major Mvmt	NBL	NBT	NBR	EBLn1	WBLn1	SBL	SBT	SBR
Capacity (veh/h)	1225	-	-	478	445	1281	-	-
HCM Lane V/C Ratio	0.002	-	-	0.075	0.054	0.004	-	-
HCM Control Delay (s)	7.9	0	-	13.1	13.6	7.8	0	-
HCM Lane LOS	A	A	-	B	B	A	A	-
HCM 95th %tile Q(veh)	0	-	-	0.2	0.2	0	-	-

Intersection												
Int Delay, s/veh	1.1											
Movement	EBL	EBT	EBR	WBL	WBT	WBR	NBL	NBT	NBR	SBL	SBT	SBR
Lane Configurations		↕			↕		↗	↗	↗	↗	↗	↗
Traffic Vol, veh/h	1	11	12	2	9	0	7	487	0	1	818	5
Future Vol, veh/h	1	11	12	2	9	0	7	487	0	1	818	5
Conflicting Peds, #/hr	0	0	0	0	0	0	0	0	0	0	0	0
Sign Control	Stop	Stop	Stop	Stop	Stop	Stop	Free	Free	Free	Free	Free	Free
RT Channelized	-	-	None	-	-	None	-	-	Free	-	-	Free
Storage Length	-	-	-	-	-	-	515	-	515	520	-	480
Veh in Median Storage, #	-	0	-	-	0	-	-	0	-	-	0	-
Grade, %	-	0	-	-	0	-	-	0	-	-	0	-
Peak Hour Factor	67	67	67	69	69	69	92	92	92	91	91	91
Heavy Vehicles, %	10	10	10	10	10	10	10	10	10	10	10	10
Mvmt Flow	1	16	18	3	13	0	8	529	0	1	899	5

Major/Minor	Minor2		Minor1			Major1		Major2				
Conflicting Flow All	1188	1446	450	1005	1446	265	899	0	-	529	0	0
Stage 1	901	901	-	545	545	-	-	-	-	-	-	-
Stage 2	287	545	-	460	901	-	-	-	-	-	-	-
Critical Hdwy	7.7	6.7	7.1	7.7	6.7	7.1	4.3	-	-	4.3	-	-
Critical Hdwy Stg 1	6.7	5.7	-	6.7	5.7	-	-	-	-	-	-	-
Critical Hdwy Stg 2	6.7	5.7	-	6.7	5.7	-	-	-	-	-	-	-
Follow-up Hdwy	3.6	4.1	3.4	3.6	4.1	3.4	2.3	-	-	2.3	-	-
Pot Cap-1 Maneuver	135	121	535	185	121	710	703	-	0	981	-	0
Stage 1	284	337	-	470	497	-	-	-	0	-	-	0
Stage 2	674	497	-	530	337	-	-	-	0	-	-	0
Platoon blocked, %								-			-	
Mov Cap-1 Maneuver	123	120	535	159	120	710	703	-	-	981	-	-
Mov Cap-2 Maneuver	123	120	-	159	120	-	-	-	-	-	-	-
Stage 1	281	337	-	465	492	-	-	-	-	-	-	-
Stage 2	649	492	-	487	337	-	-	-	-	-	-	-

Approach	EB	WB	NB	SB
HCM Control Delay, s	27.4	37.7	0.1	0
HCM LOS	D	E		

Minor Lane/Major Mvmt	NBL	NBT	EBLn1	WBLn1	SBL	SBT
Capacity (veh/h)	703	-	196	126	981	-
HCM Lane V/C Ratio	0.011	-	0.183	0.127	0.001	-
HCM Control Delay (s)	10.2	-	27.4	37.7	8.7	-
HCM Lane LOS	B	-	D	E	A	-
HCM 95th %tile Q(veh)	0	-	0.7	0.4	0	-



HCM 6th Signalized Intersection Summary  
 9: SR-86 & Worthington Rd/E Barioni Blvd

Existing PM  
 03/30/2023

Movement	EBL	EBT	EBR	WBL	WBT	WBR	NBL	NBT	NBR	SBL	SBT	SBR
Lane Configurations												
Traffic Volume (veh/h)	55	115	192	125	101	44	106	811	35	47	848	49
Future Volume (veh/h)	55	115	192	125	101	44	106	811	35	47	848	49
Initial Q (Qb), veh	0	0	0	0	0	0	0	0	0	0	0	0
Ped-Bike Adj(A_pbT)	1.00		0.98	1.00		0.98	1.00		0.99	1.00		0.99
Parking Bus, Adj	1.00	1.00	1.00	1.00	1.00	1.00	1.00	1.00	1.00	1.00	1.00	1.00
Work Zone On Approach		No			No			No			No	
Adj Sat Flow, veh/h/ln	1752	1752	1752	1752	1752	1752	1752	1752	1752	1752	1752	1752
Adj Flow Rate, veh/h	74	155	259	154	125	54	120	922	40	55	998	58
Peak Hour Factor	0.74	0.74	0.74	0.81	0.81	0.81	0.88	0.88	0.88	0.85	0.85	0.85
Percent Heavy Veh, %	10	10	10	10	10	10	10	10	10	10	10	10
Cap, veh/h	111	233	291	178	144	275	143	1183	51	70	1024	60
Arrive On Green	0.20	0.20	0.20	0.19	0.19	0.19	0.09	0.36	0.36	0.04	0.32	0.32
Sat Flow, veh/h	557	1167	1458	941	764	1456	1668	3248	141	1668	3195	186
Grp Volume(v), veh/h	229	0	259	279	0	54	120	472	490	55	520	536
Grp Sat Flow(s),veh/h/ln	1724	0	1458	1705	0	1456	1668	1664	1725	1668	1664	1716
Q Serve(g_s), s	10.7	0.0	15.2	13.9	0.0	2.7	6.2	22.1	22.1	2.9	27.1	27.1
Cycle Q Clear(g_c), s	10.7	0.0	15.2	13.9	0.0	2.7	6.2	22.1	22.1	2.9	27.1	27.1
Prop In Lane	0.32		1.00	0.55		1.00	1.00		0.08	1.00		0.11
Lane Grp Cap(c), veh/h	344	0	291	322	0	275	143	606	628	70	533	550
V/C Ratio(X)	0.67	0.00	0.89	0.87	0.00	0.20	0.84	0.78	0.78	0.78	0.97	0.97
Avail Cap(c_a), veh/h	356	0	301	356	0	304	143	606	628	101	533	550
HCM Platoon Ratio	1.00	1.00	1.00	1.00	1.00	1.00	1.00	1.00	1.00	1.00	1.00	1.00
Upstream Filter(I)	1.00	0.00	1.00	1.00	0.00	1.00	1.00	1.00	1.00	1.00	1.00	1.00
Uniform Delay (d), s/veh	32.4	0.0	34.1	34.5	0.0	29.9	39.5	24.8	24.8	41.6	29.4	29.4
Incr Delay (d2), s/veh	4.5	0.0	25.8	18.3	0.0	0.3	33.9	6.5	6.2	21.7	32.4	31.8
Initial Q Delay(d3),s/veh	0.0	0.0	0.0	0.0	0.0	0.0	0.0	0.0	0.0	0.0	0.0	0.0
%ile BackOfQ(50%),veh/ln	4.8	0.0	7.3	7.3	0.0	1.0	3.8	8.9	9.2	1.5	14.6	15.0
Unsig. Movement Delay, s/veh												
LnGrp Delay(d),s/veh	36.8	0.0	59.9	52.8	0.0	30.3	73.4	31.2	31.0	63.3	61.8	61.2
LnGrp LOS	D	A	E	D	A	C	E	C	C	E	E	E
Approach Vol, veh/h		488			333			1082			1111	
Approach Delay, s/veh		49.1			49.1			35.8			61.6	
Approach LOS		D			D			D			E	
Timer - Assigned Phs	1	2		4	5	6		8				
Phs Duration (G+Y+Rc), s	8.2	36.4		22.0	12.0	32.6		21.1				
Change Period (Y+Rc), s	4.5	4.5		4.5	4.5	4.5		4.5				
Max Green Setting (Gmax), s	5.3	30.3		18.1	7.5	28.1		18.3				
Max Q Clear Time (g_c+1), s	4.9	24.1		17.2	8.2	29.1		15.9				
Green Ext Time (p_c), s	0.0	2.9		0.2	0.0	0.0		0.4				
<b>Intersection Summary</b>												
HCM 6th Ctrl Delay				48.9								
HCM 6th LOS				D								

Intersection	
Intersection Delay, s/veh	11.8
Intersection LOS	B

Movement	EBL	EBT	EBR	WBL	WBT	WBR	NBL	NBT	NBR	SBL	SBT	SBR
Lane Configurations		↕			↕			↕			↕	
Traffic Vol, veh/h	12	107	52	11	112	14	52	193	9	12	201	24
Future Vol, veh/h	12	107	52	11	112	14	52	193	9	12	201	24
Peak Hour Factor	0.91	0.91	0.91	0.78	0.78	0.78	0.95	0.95	0.95	0.97	0.97	0.97
Heavy Vehicles, %	10	10	10	10	10	10	10	10	10	10	10	10
Mvmt Flow	13	118	57	14	144	18	55	203	9	12	207	25
Number of Lanes	0	1	0	0	1	0	0	1	0	0	1	0

Approach	EB	WB	NB	SB
Opposing Approach	WB	EB	SB	NB
Opposing Lanes	1	1	1	1
Conflicting Approach Left	SB	NB	EB	WB
Conflicting Lanes Left	1	1	1	1
Conflicting Approach Right	NB	SB	WB	EB
Conflicting Lanes Right	1	1	1	1
HCM Control Delay	11.1	11.1	12.5	11.9
HCM LOS	B	B	B	B

Lane	NBLn1	EBLn1	WBLn1	SBLn1
Vol Left, %	20%	7%	8%	5%
Vol Thru, %	76%	63%	82%	85%
Vol Right, %	4%	30%	10%	10%
Sign Control	Stop	Stop	Stop	Stop
Traffic Vol by Lane	254	171	137	237
LT Vol	52	12	11	12
Through Vol	193	107	112	201
RT Vol	9	52	14	24
Lane Flow Rate	267	188	176	244
Geometry Grp	1	1	1	1
Degree of Util (X)	0.413	0.295	0.283	0.375
Departure Headway (Hd)	5.56	5.661	5.802	5.531
Convergence, Y/N	Yes	Yes	Yes	Yes
Cap	647	633	618	650
Service Time	3.605	3.714	3.855	3.578
HCM Lane V/C Ratio	0.413	0.297	0.285	0.375
HCM Control Delay	12.5	11.1	11.1	11.9
HCM Lane LOS	B	B	B	B
HCM 95th-tile Q	2	1.2	1.2	1.7



HCM 6th Signalized Intersection Summary  
 11: Hwy 111 & Worthington Rd/E. Worthington Rd

Existing PM  
 03/30/2023



Movement	EBL	EBT	EBR	WBL	WBT	WBR	NBL	NBT	NBR	SBL	SBT	SBR
Lane Configurations		↕			↕		↗	↗	↗	↗	↗	↗
Traffic Volume (veh/h)	17	51	67	12	47	13	32	469	21	12	761	31
Future Volume (veh/h)	17	51	67	12	47	13	32	469	21	12	761	31
Initial Q (Qb), veh	0	0	0	0	0	0	0	0	0	0	0	0
Ped-Bike Adj(A_pbT)	1.00		1.00	1.00		1.00	1.00		1.00	1.00		1.00
Parking Bus, Adj	1.00	1.00	1.00	1.00	1.00	1.00	1.00	1.00	1.00	1.00	1.00	1.00
Work Zone On Approach		No			No			No			No	
Adj Sat Flow, veh/h/ln	1870	1870	1870	1870	1870	1870	1870	1870	1870	1870	1870	1870
Adj Flow Rate, veh/h	20	61	80	15	60	17	34	494	0	14	885	0
Peak Hour Factor	0.84	0.84	0.84	0.79	0.78	0.78	0.95	0.95	0.95	0.86	0.86	0.86
Percent Heavy Veh, %	2	2	2	2	2	2	2	2	2	2	2	2
Cap, veh/h	120	169	189	129	295	73	167	1442		77	1262	
Arrive On Green	0.23	0.23	0.23	0.23	0.23	0.23	0.09	0.41	0.00	0.04	0.36	0.00
Sat Flow, veh/h	102	742	834	126	1300	323	1781	3554	1585	1781	3554	1585
Grp Volume(v), veh/h	161	0	0	92	0	0	34	494	0	14	885	0
Grp Sat Flow(s),veh/h/ln1678	0	0	1749	0	0	1781	1777	1585	1781	1777	1585	
Q Serve(g_s), s	0.0	0.0	0.0	0.0	0.0	0.0	0.7	4.0	0.0	0.3	8.9	0.0
Cycle Q Clear(g_c), s	3.3	0.0	0.0	1.7	0.0	0.0	0.7	4.0	0.0	0.3	8.9	0.0
Prop In Lane	0.12		0.50	0.16		0.18	1.00		1.00	1.00		1.00
Lane Grp Cap(c), veh/h	478	0	0	498	0	0	167	1442		77	1262	
V/C Ratio(X)	0.34	0.00	0.00	0.18	0.00	0.00	0.20	0.34		0.18	0.70	
Avail Cap(c_a), veh/h	814	0	0	841	0	0	513	1833		513	1833	
HCM Platoon Ratio	1.00	1.00	1.00	1.00	1.00	1.00	1.00	1.00	1.00	1.00	1.00	1.00
Upstream Filter(I)	1.00	0.00	0.00	1.00	0.00	0.00	1.00	1.00	0.00	1.00	1.00	0.00
Uniform Delay (d), s/veh	13.7	0.0	0.0	13.1	0.0	0.0	17.4	8.5	0.0	19.2	11.5	0.0
Incr Delay (d2), s/veh	0.4	0.0	0.0	0.2	0.0	0.0	0.6	0.1	0.0	1.1	0.7	0.0
Initial Q Delay(d3),s/veh	0.0	0.0	0.0	0.0	0.0	0.0	0.0	0.0	0.0	0.0	0.0	0.0
%ile BackOfQ(50%),veh/ln	1.1	0.0	0.0	0.6	0.0	0.0	0.3	0.8	0.0	0.1	2.2	0.0
Unsig. Movement Delay, s/veh												
LnGrp Delay(d),s/veh	14.1	0.0	0.0	13.3	0.0	0.0	18.0	8.7	0.0	20.4	12.3	0.0
LnGrp LOS	B	A	A	B	A	A	B	A		C	B	
Approach Vol, veh/h		161			92			528			899	
Approach Delay, s/veh		14.1			13.3			9.3			12.4	
Approach LOS		B			B			A			B	
Timer - Assigned Phs	1	2		4	5	6		8				
Phs Duration (G+Y+Rc), s6.3	21.4			14.0	8.4	19.3		14.0				
Change Period (Y+Rc), s 4.5	4.5			4.5	4.5	4.5		4.5				
Max Green Setting (Gmax)6.0	21.5			18.0	12.0	21.5		18.0				
Max Q Clear Time (g_c+I)3.0	6.0			5.3	2.7	10.9		3.7				
Green Ext Time (p_c), s 0.0	2.4			0.7	0.0	3.9		0.3				

Intersection Summary

HCM 6th Ctrl Delay	11.6
HCM 6th LOS	B

Notes





















Unsignalized Delay for [NBR, SBR] is excluded from calculations of the approach delay and intersection delay.



**APPENDIX C**  
**INTERSECTION ANALYSIS WORKSHEETS – OPENING**  
**YEAR WITHOUT PROJECT**

HCM 6th Signalized Intersection Summary  
1: SR-86 & W Keystone Rd

Near Term AM  
03/30/2023

												
Movement	EBL	EBT	EBR	WBL	WBT	WBR	NBL	NBT	NBR	SBL	SBT	SBR
Lane Configurations												
Traffic Volume (veh/h)	51	49	15	27	45	45	23	456	53	40	467	32
Future Volume (veh/h)	51	49	15	27	45	45	23	456	53	40	467	32
Initial Q (Qb), veh	0	0	0	0	0	0	0	0	0	0	0	0
Ped-Bike Adj(A_pbT)	1.00		1.00	1.00		1.00	1.00		1.00	1.00		1.00
Parking Bus, Adj	1.00	1.00	1.00	1.00	1.00	1.00	1.00	1.00	1.00	1.00	1.00	1.00
Work Zone On Approach		No			No			No			No	
Adj Sat Flow, veh/h/ln	1752	1752	1752	1752	1752	1752	1752	1752	1752	1752	1752	1752
Adj Flow Rate, veh/h	59	56	17	54	82	82	29	570	66	54	631	43
Peak Hour Factor	0.87	0.87	0.87	0.50	0.55	0.55	0.80	0.80	0.80	0.74	0.74	0.74
Percent Heavy Veh, %	10	10	10	10	10	10	10	10	10	10	10	10
Cap, veh/h	190	156	37	132	132	111	87	1087	485	135	1184	528
Arrive On Green	0.19	0.19	0.19	0.19	0.19	0.19	0.05	0.33	0.33	0.08	0.36	0.36
Sat Flow, veh/h	516	823	198	275	698	587	1668	3328	1485	1668	3328	1485
Grp Volume(v), veh/h	132	0	0	218	0	0	29	570	66	54	631	43
Grp Sat Flow(s),veh/h/ln	1536	0	0	1560	0	0	1668	1664	1485	1668	1664	1485
Q Serve(g_s), s	0.0	0.0	0.0	3.3	0.0	0.0	0.9	7.8	1.8	1.7	8.4	1.1
Cycle Q Clear(g_c), s	4.0	0.0	0.0	7.2	0.0	0.0	0.9	7.8	1.8	1.7	8.4	1.1
Prop In Lane	0.45		0.13	0.25		0.38	1.00		1.00	1.00		1.00
Lane Grp Cap(c), veh/h	383	0	0	375	0	0	87	1087	485	135	1184	528
V/C Ratio(X)	0.34	0.00	0.00	0.58	0.00	0.00	0.34	0.52	0.14	0.40	0.53	0.08
Avail Cap(c_a), veh/h	1150	0	0	1201	0	0	247	1871	834	280	1936	864
HCM Platoon Ratio	1.00	1.00	1.00	1.00	1.00	1.00	1.00	1.00	1.00	1.00	1.00	1.00
Upstream Filter(I)	1.00	0.00	0.00	1.00	0.00	0.00	1.00	1.00	1.00	1.00	1.00	1.00
Uniform Delay (d), s/veh	20.0	0.0	0.0	21.3	0.0	0.0	25.6	15.3	13.3	24.4	14.3	12.0
Incr Delay (d2), s/veh	0.5	0.0	0.0	1.4	0.0	0.0	0.8	1.4	0.5	0.7	1.4	0.2
Initial Q Delay(d3),s/veh	0.0	0.0	0.0	0.0	0.0	0.0	0.0	0.0	0.0	0.0	0.0	0.0
%ile BackOfQ(50%),veh/ln	1.4	0.0	0.0	2.6	0.0	0.0	0.4	2.6	0.5	0.6	2.7	0.3
Unsig. Movement Delay, s/veh												
LnGrp Delay(d),s/veh	20.5	0.0	0.0	22.7	0.0	0.0	26.5	16.8	13.8	25.2	15.7	12.2
LnGrp LOS	C	A	A	C	A	A	C	B	B	C	B	B
Approach Vol, veh/h		132			218			665			728	
Approach Delay, s/veh		20.5			22.7			16.9			16.2	
Approach LOS		C			C			B			B	
Timer - Assigned Phs	1	2		4	5	6		8				
Phs Duration (G+Y+Rc), s	10.2	26.7		19.1	8.6	28.3		19.1				
Change Period (Y+Rc), s	* 5.7	* 8.4		8.5	* 5.7	* 8.4		8.5				
Max Green Setting (Gmax), s	* 9.4	* 32		41.5	* 8.3	* 33		41.5				
Max Q Clear Time (g_c+1), s	3.7	9.8		6.0	2.9	10.4		9.2				
Green Ext Time (p_c), s	0.0	8.5		0.8	0.0	9.3		1.4				
<b>Intersection Summary</b>												
HCM 6th Ctrl Delay	17.6											
HCM 6th LOS	B											
<b>Notes</b>												
* HCM 6th computational engine requires equal clearance times for the phases crossing the barrier.												

Intersection

Intersection Delay, s/veh 9.1

Intersection LOS A

Movement	EBL	EBT	EBR	WBL	WBT	WBR	NBL	NBT	NBR	SBL	SBT	SBR
Lane Configurations		↕			↕			↕			↕	
Traffic Vol, veh/h	19	46	11	3	47	13	23	103	4	10	158	19
Future Vol, veh/h	19	46	11	3	47	13	23	103	4	10	158	19
Peak Hour Factor	0.86	0.86	0.86	0.67	0.67	0.67	0.86	0.86	0.86	0.86	0.86	0.86
Heavy Vehicles, %	10	10	10	10	10	10	10	10	10	10	10	10
Mvmt Flow	22	53	13	4	70	19	27	120	5	12	184	22
Number of Lanes	0	1	0	0	1	0	0	1	0	0	1	0

Approach	EB	WB	NB	SB
Opposing Approach	WB	EB	SB	NB
Opposing Lanes	1	1	1	1
Conflicting Approach Left SB		NB	EB	WB
Conflicting Lanes Left	1	1	1	1
Conflicting Approach Right NB		SB	WB	EB
Conflicting Lanes Right	1	1	1	1
HCM Control Delay	8.8	8.7	9.1	9.5
HCM LOS	A	A	A	A

Lane	NBLn1	EBLn1	WBLn1	SBLn1
Vol Left, %	18%	25%	5%	5%
Vol Thru, %	79%	61%	75%	84%
Vol Right, %	3%	14%	21%	10%
Sign Control	Stop	Stop	Stop	Stop
Traffic Vol by Lane	130	76	63	187
LT Vol	23	19	3	10
Through Vol	103	46	47	158
RT Vol	4	11	13	19
Lane Flow Rate	151	88	94	217
Geometry Grp	1	1	1	1
Degree of Util (X)	0.202	0.124	0.129	0.281
Departure Headway (Hd)	4.8	5.034	4.95	4.66
Convergence, Y/N	Yes	Yes	Yes	Yes
Cap	745	710	721	770
Service Time	2.842	3.084	3	2.699
HCM Lane V/C Ratio	0.203	0.124	0.13	0.282
HCM Control Delay	9.1	8.8	8.7	9.5
HCM Lane LOS	A	A	A	A
HCM 95th-tile Q	0.8	0.4	0.4	1.2



HCM 6th Signalized Intersection Summary  
3: Hwy 111 & E Keystone Rd

Near Term AM  
03/30/2023



Movement	EBL	EBT	EBR	WBL	WBT	WBR	NBL	NBT	NBR	SBL	SBT	SBR
Lane Configurations		↔			↔		↗	↗	↗	↗	↗	↗
Traffic Volume (veh/h)	14	10	51	0	8	1	63	609	2	2	629	3
Future Volume (veh/h)	14	10	51	0	8	1	63	609	2	2	629	3
Initial Q (Qb), veh	0	0	0	0	0	0	0	0	0	0	0	0
Ped-Bike Adj(A_pbT)	1.00		1.00	1.00		1.00	1.00		1.00	1.00		1.00
Parking Bus, Adj	1.00	1.00	1.00	1.00	1.00	1.00	1.00	1.00	1.00	1.00	1.00	1.00
Work Zone On Approach		No			No			No			No	
Adj Sat Flow, veh/h/ln	1752	1752	1752	1752	1752	1752	1752	1752	1752	1752	1752	1752
Adj Flow Rate, veh/h	17	12	62	0	14	2	70	677	2	2	749	4
Peak Hour Factor	0.82	0.82	0.82	0.58	0.58	0.58	0.90	0.90	0.90	0.84	0.84	0.84
Percent Heavy Veh, %	10	10	10	10	10	10	10	10	10	10	10	10
Cap, veh/h	104	55	169	0	246	35	202	1418	632	9	1033	461
Arrive On Green	0.16	0.16	0.16	0.00	0.16	0.16	0.12	0.43	0.43	0.01	0.31	0.31
Sat Flow, veh/h	147	336	1033	0	1499	214	1668	3328	1485	1668	3328	1485
Grp Volume(v), veh/h	91	0	0	0	0	16	70	677	2	2	749	4
Grp Sat Flow(s),veh/h/ln	1516	0	0	0	0	1713	1668	1664	1485	1668	1664	1485
Q Serve(g_s), s	0.0	0.0	0.0	0.0	0.0	0.4	2.1	7.8	0.0	0.1	10.7	0.1
Cycle Q Clear(g_c), s	2.8	0.0	0.0	0.0	0.0	0.4	2.1	7.8	0.0	0.1	10.7	0.1
Prop In Lane	0.19		0.68	0.00		0.12	1.00		1.00	1.00		1.00
Lane Grp Cap(c), veh/h	329	0	0	0	0	281	202	1418	632	9	1033	461
V/C Ratio(X)	0.28	0.00	0.00	0.00	0.00	0.06	0.35	0.48	0.00	0.22	0.72	0.01
Avail Cap(c_a), veh/h	1498	0	0	0	0	1637	313	1709	762	313	1709	762
HCM Platoon Ratio	1.00	1.00	1.00	1.00	1.00	1.00	1.00	1.00	1.00	1.00	1.00	1.00
Upstream Filter(l)	1.00	0.00	0.00	0.00	0.00	1.00	1.00	1.00	1.00	1.00	1.00	1.00
Uniform Delay (d), s/veh	19.8	0.0	0.0	0.0	0.0	18.8	21.5	11.0	8.8	26.4	16.4	12.7
Incr Delay (d2), s/veh	0.5	0.0	0.0	0.0	0.0	0.1	1.0	0.3	0.0	11.6	1.0	0.0
Initial Q Delay(d3),s/veh	0.0	0.0	0.0	0.0	0.0	0.0	0.0	0.0	0.0	0.0	0.0	0.0
%ile BackOfQ(50%),veh/ln	0.0	0.0	0.0	0.0	0.0	0.2	0.7	2.0	0.0	0.1	3.1	0.0
Unsig. Movement Delay, s/veh												
LnGrp Delay(d),s/veh	20.3	0.0	0.0	0.0	0.0	18.9	22.5	11.3	8.8	38.0	17.4	12.7
LnGrp LOS	C	A	A	A	A	B	C	B	A	D	B	B
Approach Vol, veh/h		91			16			749			755	
Approach Delay, s/veh		20.3			18.9			12.3			17.4	
Approach LOS		C			B			B			B	
Timer - Assigned Phs	1	2		4	5	6		8				
Phs Duration (G+Y+Rc), s	6.0	31.1		16.2	12.2	25.0		16.2				
Change Period (Y+Rc), s	5.7	* 8.4		7.5	* 5.7	* 8.4		7.5				
Max Green Setting (Gmax), s		* 27		51.0	* 10	* 27		51.0				
Max Q Clear Time (g_c+I), s		9.8		4.8	4.1	12.7		2.4				
Green Ext Time (p_c), s	0.0	3.7		0.6	0.1	3.9		0.1				

Intersection Summary

HCM 6th Ctrl Delay	15.2
HCM 6th LOS	B

Notes

\* HCM 6th computational engine requires equal clearance times for the phases crossing the barrier.

Intersection						
Int Delay, s/veh	0					
Movement	WBL	WBR	NBT	NBR	SBL	SBT
Lane Configurations		↗	↗↗			↗↗
Traffic Vol, veh/h	0	0	532	0	0	509
Future Vol, veh/h	0	0	532	0	0	509
Conflicting Peds, #/hr	0	0	0	0	0	0
Sign Control	Stop	Stop	Free	Free	Free	Free
RT Channelized	-	None	-	None	-	None
Storage Length	-	0	-	-	-	-
Veh in Median Storage, #	0	-	0	-	-	0
Grade, %	0	-	0	-	-	0
Peak Hour Factor	92	92	92	92	92	92
Heavy Vehicles, %	10	10	10	10	10	10
Mvmt Flow	0	0	578	0	0	553

Major/Minor	Minor1	Major1	Major2		
Conflicting Flow All	-	289	0	-	-
Stage 1	-	-	-	-	-
Stage 2	-	-	-	-	-
Critical Hdwy	-	7.1	-	-	-
Critical Hdwy Stg 1	-	-	-	-	-
Critical Hdwy Stg 2	-	-	-	-	-
Follow-up Hdwy	-	3.4	-	-	-
Pot Cap-1 Maneuver	0	684	-	0	0
Stage 1	0	-	-	0	0
Stage 2	0	-	-	0	0
Platoon blocked, %			-		-
Mov Cap-1 Maneuver	-	684	-	-	-
Mov Cap-2 Maneuver	-	-	-	-	-
Stage 1	-	-	-	-	-
Stage 2	-	-	-	-	-

Approach	WB	NB	SB
HCM Control Delay, s	0	0	0
HCM LOS	A		

Minor Lane/Major Mvmt	NBTWBLn1	SBT
Capacity (veh/h)	-	-
HCM Lane V/C Ratio	-	-
HCM Control Delay (s)	-	0
HCM Lane LOS	-	A
HCM 95th %tile Q(veh)	-	-



**Intersection**

Int Delay, s/veh 0

Movement	WBL	WBR	NBT	NBR	SBL	SBT
Lane Configurations		↗	↕			↕
Traffic Vol, veh/h	0	0	532	0	0	509
Future Vol, veh/h	0	0	532	0	0	509
Conflicting Peds, #/hr	0	0	0	0	0	0
Sign Control	Stop	Stop	Free	Free	Free	Free
RT Channelized	-	None	-	None	-	None
Storage Length	-	0	-	-	-	-
Veh in Median Storage, #	0	-	0	-	-	0
Grade, %	0	-	0	-	-	0
Peak Hour Factor	92	92	92	92	92	92
Heavy Vehicles, %	10	10	10	10	10	10
Mvmt Flow	0	0	578	0	0	553

Major/Minor	Minor1	Major1	Major2
Conflicting Flow All	-	289	0
Stage 1	-	-	-
Stage 2	-	-	-
Critical Hdwy	-	7.1	-
Critical Hdwy Stg 1	-	-	-
Critical Hdwy Stg 2	-	-	-
Follow-up Hdwy	-	3.4	-
Pot Cap-1 Maneuver	0	684	0
Stage 1	0	-	0
Stage 2	0	-	0
Platoon blocked, %	-	-	-
Mov Cap-1 Maneuver	-	684	-
Mov Cap-2 Maneuver	-	-	-
Stage 1	-	-	-
Stage 2	-	-	-

Approach	WB	NB	SB
HCM Control Delay, s	0	0	0
HCM LOS	A		

Minor Lane/Major Mvmt	NBT	NBRWBLn1	SBT
Capacity (veh/h)	-	-	-
HCM Lane V/C Ratio	-	-	-
HCM Control Delay (s)	-	0	-
HCM Lane LOS	-	A	-
HCM 95th %tile Q(veh)	-	-	-

Intersection												
Int Delay, s/veh	0.6											
Movement	EBL	EBT	EBR	WBL	WBT	WBR	NBL	NBT	NBR	SBL	SBT	SBR
Lane Configurations	↕			↕			↕			↕		
Traffic Vol, veh/h	0	4	0	2	5	17	0	560	4	6	510	0
Future Vol, veh/h	0	4	0	2	5	17	0	560	4	6	510	0
Conflicting Peds, #/hr	0	0	0	0	0	0	0	0	0	0	0	0
Sign Control	Stop	Stop	Stop	Stop	Stop	Stop	Free	Free	Free	Free	Free	Free
RT Channelized	-	-	None	-	-	None	-	-	None	-	-	None
Storage Length	-	-	-	-	-	-	-	-	-	-	-	-
Veh in Median Storage, #	-	0	-	-	0	-	-	0	-	-	0	-
Grade, %	-	0	-	-	0	-	-	0	-	-	0	-
Peak Hour Factor	92	92	92	68	68	68	83	83	83	80	80	80
Heavy Vehicles, %	10	10	10	10	10	10	10	10	10	10	10	10
Mvmt Flow	0	4	0	3	7	25	0	675	5	8	638	0

Major/Minor	Minor2		Minor1		Major1			Major2				
Conflicting Flow All	995	1334	319	1015	1332	340	638	0	0	680	0	0
Stage 1	654	654	-	678	678	-	-	-	-	-	-	-
Stage 2	341	680	-	337	654	-	-	-	-	-	-	-
Critical Hdwy	7.7	6.7	7.1	7.7	6.7	7.1	4.3	-	-	4.3	-	-
Critical Hdwy Stg 1	6.7	5.7	-	6.7	5.7	-	-	-	-	-	-	-
Critical Hdwy Stg 2	6.7	5.7	-	6.7	5.7	-	-	-	-	-	-	-
Follow-up Hdwy	3.6	4.1	3.4	3.6	4.1	3.4	2.3	-	-	2.3	-	-
Pot Cap-1 Maneuver	188	143	654	182	143	633	889	-	-	857	-	-
Stage 1	403	442	-	390	431	-	-	-	-	-	-	-
Stage 2	626	430	-	629	442	-	-	-	-	-	-	-
Platoon blocked, %												
Mov Cap-1 Maneuver	171	141	654	176	141	633	889	-	-	857	-	-
Mov Cap-2 Maneuver	171	141	-	176	141	-	-	-	-	-	-	-
Stage 1	403	436	-	390	431	-	-	-	-	-	-	-
Stage 2	591	430	-	614	436	-	-	-	-	-	-	-

Approach	EB		WB		NB		SB	
HCM Control Delay, s	31.3		17.4		0		0.2	
HCM LOS	D		C					

Minor Lane/Major Mvmt	NBL	NBT	NBR	EBLn1	WBLn1	SBL	SBT	SBR
Capacity (veh/h)	889	-	-	141	326	857	-	-
HCM Lane V/C Ratio	-	-	-	0.031	0.108	0.009	-	-
HCM Control Delay (s)	0	-	-	31.3	17.4	9.2	0.1	-
HCM Lane LOS	A	-	-	D	C	A	A	-
HCM 95th %tile Q(veh)	0	-	-	0.1	0.4	0	-	-



**Intersection**

Int Delay, s/veh 2.1

Movement	EBL	EBT	EBR	WBL	WBT	WBR	NBL	NBT	NBR	SBL	SBT	SBR
Lane Configurations		↕			↕			↕			↕	
Traffic Vol, veh/h	4	9	3	6	24	9	3	164	6	5	219	2
Future Vol, veh/h	4	9	3	6	24	9	3	164	6	5	219	2
Conflicting Peds, #/hr	0	0	0	0	0	0	0	0	0	0	0	0
Sign Control	Stop	Stop	Stop	Stop	Stop	Stop	Free	Free	Free	Free	Free	Free
RT Channelized	-	-	None	-	-	None	-	-	None	-	-	None
Storage Length	-	-	-	-	-	-	-	-	-	-	-	-
Veh in Median Storage, #	-	0	-	-	0	-	-	0	-	-	0	-
Grade, %	-	0	-	-	0	-	-	0	-	-	0	-
Peak Hour Factor	60	60	60	64	64	64	76	76	76	76	76	76
Heavy Vehicles, %	10	10	10	10	10	10	10	10	10	10	10	10
Mvmt Flow	7	15	5	9	38	14	4	216	8	7	288	3

Major/Minor	Minor2	Minor1	Major1	Major2
Conflicting Flow All	558	536	290	542
Stage 1	304	304	-	228
Stage 2	254	232	-	314
Critical Hdwy	7.2	6.6	6.3	7.2
Critical Hdwy Stg 1	6.2	5.6	-	6.2
Critical Hdwy Stg 2	6.2	5.6	-	6.2
Follow-up Hdwy	3.59	4.09	3.39	3.59
Pot Cap-1 Maneuver	428	440	731	439
Stage 1	689	649	-	757
Stage 2	733	698	-	680
Platoon blocked, %				
Mov Cap-1 Maneuver	390	436	731	421
Mov Cap-2 Maneuver	390	436	-	421
Stage 1	686	645	-	754
Stage 2	679	695	-	656

Approach	EB	WB	NB	SB
HCM Control Delay, s	13.4	13.5	0.1	0.2
HCM LOS	B	B		

Minor Lane/Major Mvmt	NBL	NBT	NBR	EBLn1	WBLn1	SBL	SBT	SBR
Capacity (veh/h)	1226	-	-	457	486	1299	-	-
HCM Lane V/C Ratio	0.003	-	-	0.058	0.125	0.005	-	-
HCM Control Delay (s)	7.9	0	-	13.4	13.5	7.8	0	-
HCM Lane LOS	A	A	-	B	B	A	A	-
HCM 95th %tile Q(veh)	0	-	-	0.2	0.4	0	-	-

Intersection												
Int Delay, s/veh	2.8											
Movement	EBL	EBT	EBR	WBL	WBT	WBR	NBL	NBT	NBR	SBL	SBT	SBR
Lane Configurations		↕			↕		↗	↗	↗	↗	↗	↗
Traffic Vol, veh/h	13	6	11	3	9	2	39	601	2	1	608	14
Future Vol, veh/h	13	6	11	3	9	2	39	601	2	1	608	14
Conflicting Peds, #/hr	0	0	0	0	0	0	0	0	0	0	0	0
Sign Control	Stop	Stop	Stop	Stop	Stop	Stop	Free	Free	Free	Free	Free	Free
RT Channelized	-	-	None	-	-	None	-	-	Free	-	-	Free
Storage Length	-	-	-	-	-	-	515	-	515	520	-	480
Veh in Median Storage, #	-	0	-	-	0	-	-	0	-	-	0	-
Grade, %	-	0	-	-	0	-	-	0	-	-	0	-
Peak Hour Factor	50	50	50	42	42	42	86	86	86	88	88	88
Heavy Vehicles, %	10	10	10	10	10	10	10	10	10	10	10	10
Mvmt Flow	26	12	22	7	21	5	45	699	2	1	691	16

Major/Minor	Minor2		Minor1		Major1		Major2					
Conflicting Flow All	1143	1482	346	1143	1482	350	691	0	-	699	0	0
Stage 1	693	693	-	789	789	-	-	-	-	-	-	-
Stage 2	450	789	-	354	693	-	-	-	-	-	-	-
Critical Hdwy	7.7	6.7	7.1	7.7	6.7	7.1	4.3	-	-	4.3	-	-
Critical Hdwy Stg 1	6.7	5.7	-	6.7	5.7	-	-	-	-	-	-	-
Critical Hdwy Stg 2	6.7	5.7	-	6.7	5.7	-	-	-	-	-	-	-
Follow-up Hdwy	3.6	4.1	3.4	3.6	4.1	3.4	2.3	-	-	2.3	-	-
Pot Cap-1 Maneuver	146	115	627	146	115	624	848	-	0	842	-	0
Stage 1	382	424	-	333	382	-	-	-	0	-	-	0
Stage 2	537	382	-	614	424	-	-	-	0	-	-	0
Platoon blocked, %												
Mov Cap-1 Maneuver	118	109	627	124	109	624	848	-	-	842	-	-
Mov Cap-2 Maneuver	118	109	-	124	109	-	-	-	-	-	-	-
Stage 1	362	424	-	315	362	-	-	-	-	-	-	-
Stage 2	475	362	-	575	424	-	-	-	-	-	-	-

Approach	EB	WB	NB	SB
HCM Control Delay, s	39.1	43.1	0.6	0
HCM LOS	E	E		

Minor Lane/Major Mvmt	NBL	NBT	EBLn1	WBLn1	SBL	SBT
Capacity (veh/h)	848	-	164	127	842	-
HCM Lane V/C Ratio	0.053	-	0.366	0.262	0.001	-
HCM Control Delay (s)	9.5	-	39.1	43.1	9.3	-
HCM Lane LOS	A	-	E	E	A	-
HCM 95th %tile Q(veh)	0.2	-	1.5	1	0	-



HCM 6th Signalized Intersection Summary  
9: SR-86 & Worthington Rd/E Barioni Blvd

Near Term AM  
03/30/2023

Movement	EBL	EBT	EBR	WBL	WBT	WBR	NBL	NBT	NBR	SBL	SBT	SBR
Lane Configurations												
Traffic Volume (veh/h)	82	113	233	119	80	43	131	681	72	51	786	41
Future Volume (veh/h)	82	113	233	119	80	43	131	681	72	51	786	41
Initial Q (Qb), veh	0	0	0	0	0	0	0	0	0	0	0	0
Ped-Bike Adj(A_pbT)	1.00		1.00	1.00		0.99	1.00		1.00	1.00		1.00
Parking Bus, Adj	1.00	1.00	1.00	1.00	1.00	1.00	1.00	1.00	1.00	1.00	1.00	1.00
Work Zone On Approach		No			No			No			No	
Adj Sat Flow, veh/h/ln	1752	1752	1752	1752	1752	1752	1752	1752	1752	1752	1752	1752
Adj Flow Rate, veh/h	94	130	268	142	95	51	158	820	87	61	936	49
Peak Hour Factor	0.87	0.87	0.87	0.84	0.84	0.84	0.83	0.83	0.83	0.84	0.84	0.84
Percent Heavy Veh, %	10	10	10	10	10	10	10	10	10	10	10	10
Cap, veh/h	146	203	301	170	114	247	182	1131	120	76	995	52
Arrive On Green	0.20	0.20	0.20	0.17	0.17	0.17	0.11	0.37	0.37	0.05	0.31	0.31
Sat Flow, veh/h	720	996	1478	1019	682	1477	1668	3035	322	1668	3217	168
Grp Volume(v), veh/h	224	0	268	237	0	51	158	450	457	61	484	501
Grp Sat Flow(s),veh/h/ln	1716	0	1478	1701	0	1477	1668	1664	1693	1668	1664	1721
Q Serve(g_s), s	10.2	0.0	15.0	11.5	0.0	2.5	7.9	19.8	19.8	3.1	24.2	24.2
Cycle Q Clear(g_c), s	10.2	0.0	15.0	11.5	0.0	2.5	7.9	19.8	19.8	3.1	24.2	24.2
Prop In Lane	0.42		1.00	0.60		1.00	1.00		0.19	1.00		0.10
Lane Grp Cap(c), veh/h	349	0	301	284	0	247	182	620	631	76	515	532
V/C Ratio(X)	0.64	0.00	0.89	0.83	0.00	0.21	0.87	0.72	0.72	0.80	0.94	0.94
Avail Cap(c_a), veh/h	364	0	314	361	0	314	182	620	631	112	517	535
HCM Platoon Ratio	1.00	1.00	1.00	1.00	1.00	1.00	1.00	1.00	1.00	1.00	1.00	1.00
Upstream Filter(I)	1.00	0.00	1.00	1.00	0.00	1.00	1.00	1.00	1.00	1.00	1.00	1.00
Uniform Delay (d), s/veh	31.1	0.0	33.0	34.4	0.0	30.6	37.4	23.0	23.0	40.3	28.7	28.7
Incr Delay (d2), s/veh	3.6	0.0	25.0	12.6	0.0	0.4	33.1	4.2	4.1	22.1	25.5	25.0
Initial Q Delay(d3),s/veh	0.0	0.0	0.0	0.0	0.0	0.0	0.0	0.0	0.0	0.0	0.0	0.0
%ile BackOfQ(50%),veh/ln	4.5	0.0	7.3	5.6	0.0	0.9	4.7	7.7	7.8	1.7	12.4	12.7
Unsig. Movement Delay, s/veh												
LnGrp Delay(d),s/veh	34.7	0.0	58.1	47.0	0.0	31.0	70.5	27.2	27.1	62.4	54.2	53.6
LnGrp LOS	C	A	E	D	A	C	E	C	C	E	D	D
Approach Vol, veh/h		492			288			1065			1046	
Approach Delay, s/veh		47.4			44.1			33.6			54.4	
Approach LOS		D			D			C			D	
Timer - Assigned Phs	1	2		4	5	6		8				
Phs Duration (G+Y+Rc), s	8.4	36.3		21.8	13.8	30.9		18.7				
Change Period (Y+Rc), s	4.5	4.5		4.5	4.5	4.5		4.5				
Max Green Setting (Gmax), s	5.7	30.1		18.1	9.3	26.5		18.1				
Max Q Clear Time (g_c+1), s	5.1	21.8		17.0	9.9	26.2		13.5				
Green Ext Time (p_c), s	0.0	3.3		0.3	0.0	0.2		0.6				
<b>Intersection Summary</b>												
HCM 6th Ctrl Delay			44.5									
HCM 6th LOS			D									
<b>Notes</b>												
User approved pedestrian interval to be less than phase max green.												



<b>Intersection</b>												
Intersection Delay, s/veh	13.7											
Intersection LOS	B											

Movement	EBL	EBT	EBR	WBL	WBT	WBR	NBL	NBT	NBR	SBL	SBT	SBR
Lane Configurations		↕			↕			↕			↕	
Traffic Vol, veh/h	12	141	57	3	123	12	46	150	7	34	217	21
Future Vol, veh/h	12	141	57	3	123	12	46	150	7	34	217	21
Peak Hour Factor	0.86	0.86	0.86	0.73	0.73	0.73	0.93	0.93	0.93	0.80	0.80	0.80
Heavy Vehicles, %	10	10	10	10	10	10	10	10	10	10	10	10
Mvmt Flow	14	164	66	4	168	16	49	161	8	43	271	26
Number of Lanes	0	1	0	0	1	0	0	1	0	0	1	0

Approach	EB	WB	NB	SB
Opposing Approach	WB	EB	SB	NB
Opposing Lanes	1	1	1	1
Conflicting Approach Left	SB	NB	EB	WB
Conflicting Lanes Left	1	1	1	1
Conflicting Approach Right	NB	SB	WB	EB
Conflicting Lanes Right	1	1	1	1
HCM Control Delay	13	12.2	12.6	15.6
HCM LOS	B	B	B	C

Lane	NBLn1	EBLn1	WBLn1	SBLn1
Vol Left, %	23%	6%	2%	12%
Vol Thru, %	74%	67%	89%	80%
Vol Right, %	3%	27%	9%	8%
Sign Control	Stop	Stop	Stop	Stop
Traffic Vol by Lane	203	210	138	272
LT Vol	46	12	3	34
Through Vol	150	141	123	217
RT Vol	7	57	12	21
Lane Flow Rate	218	244	189	340
Geometry Grp	1	1	1	1
Degree of Util (X)	0.366	0.403	0.323	0.545
Departure Headway (Hd)	6.039	5.942	6.155	5.775
Convergence, Y/N	Yes	Yes	Yes	Yes
Cap	592	601	578	619
Service Time	4.126	4.026	4.245	3.851
HCM Lane V/C Ratio	0.368	0.406	0.327	0.549
HCM Control Delay	12.6	13	12.2	15.6
HCM Lane LOS	B	B	B	C
HCM 95th-tile Q	1.7	1.9	1.4	3.3

HCM 6th Signalized Intersection Summary  
 11: Hwy 111 & E. Worthington Rd

Near Term AM  
 03/30/2023



Movement	EBL	EBT	EBR	WBL	WBT	WBR	NBL	NBT	NBR	SBL	SBT	SBR
Lane Configurations		↔			↔		↗	↗	↗	↗	↗	↗
Traffic Volume (veh/h)	17	47	101	13	73	13	69	611	7	9	555	46
Future Volume (veh/h)	17	47	101	13	73	13	69	611	7	9	555	46
Initial Q (Qb), veh	0	0	0	0	0	0	0	0	0	0	0	0
Ped-Bike Adj(A_pbT)	1.00		1.00	1.00		1.00	1.00		1.00	1.00		1.00
Parking Bus, Adj	1.00	1.00	1.00	1.00	1.00	1.00	1.00	1.00	1.00	1.00	1.00	1.00
Work Zone On Approach	No			No			No			No		
Adj Sat Flow, veh/h/ln	1870	1870	1870	1870	1870	1870	1870	1870	1870	1870	1870	1870
Adj Flow Rate, veh/h	22	60	129	17	96	17	81	719	0	11	653	0
Peak Hour Factor	0.78	0.78	0.78	0.76	0.76	0.76	0.85	0.85	0.85	0.85	0.85	0.85
Percent Heavy Veh, %	2	2	2	2	2	2	2	2	2	2	2	2
Cap, veh/h	88	98	180	94	257	42	274	1357		60	930	
Arrive On Green	0.18	0.18	0.18	0.18	0.18	0.18	0.15	0.38	0.00	0.03	0.26	0.00
Sat Flow, veh/h	93	546	1006	118	1440	234	1781	3554	1585	1781	3554	1585
Grp Volume(v), veh/h	211	0	0	130	0	0	81	719	0	11	653	0
Grp Sat Flow(s),veh/h/ln	1646	0	0	1792	0	0	1781	1777	1585	1781	1777	1585
Q Serve(g_s), s	2.2	0.0	0.0	0.0	0.0	0.0	2.2	8.7	0.0	0.3	9.3	0.0
Cycle Q Clear(g_c), s	6.7	0.0	0.0	3.5	0.0	0.0	2.2	8.7	0.0	0.3	9.3	0.0
Prop In Lane	0.10		0.61	0.13		0.13	1.00		1.00	1.00		1.00
Lane Grp Cap(c), veh/h	365	0	0	393	0	0	274	1357		60	930	
V/C Ratio(X)	0.58	0.00	0.00	0.33	0.00	0.00	0.30	0.53		0.18	0.70	
Avail Cap(c_a), veh/h	483	0	0	517	0	0	384	1357		384	1046	
HCM Platoon Ratio	1.00	1.00	1.00	1.00	1.00	1.00	1.00	1.00	1.00	1.00	1.00	1.00
Upstream Filter(I)	1.00	0.00	0.00	1.00	0.00	0.00	1.00	1.00	0.00	1.00	1.00	0.00
Uniform Delay (d), s/veh	21.5	0.0	0.0	20.2	0.0	0.0	20.9	13.3	0.0	26.2	18.6	0.0
Incr Delay (d2), s/veh	1.8	0.0	0.0	2.2	0.0	0.0	0.2	1.5	0.0	0.5	4.4	0.0
Initial Q Delay(d3),s/veh	0.0	0.0	0.0	0.0	0.0	0.0	0.0	0.0	0.0	0.0	0.0	0.0
%ile BackOfQ(50%),veh/ln	2.6	0.0	0.0	1.6	0.0	0.0	0.8	2.8	0.0	0.1	3.5	0.0
Unsig. Movement Delay, s/veh												
LnGrp Delay(d),s/veh	23.3	0.0	0.0	22.5	0.0	0.0	21.1	14.8	0.0	26.7	23.0	0.0
LnGrp LOS	C	A	A	C	A	A	C	B		C	C	
Approach Vol, veh/h	211			130			800			664		
Approach Delay, s/veh	23.3			22.5			15.5			23.1		
Approach LOS	C			C			B			C		
Timer - Assigned Phs	1	2	4		5	6	8					
Phs Duration (G+Y+Rc), s	7.6	29.7	18.4		14.3	23.0	18.4					
Change Period (Y+Rc), s	5.7	* 8.4	8.5		* 5.7	* 8.4	8.5					
Max Green Setting (Gmax), s	20	* 16	14.0		* 12	* 16	14.0					
Max Q Clear Time (g_c+I), s	10.7	10.7	8.7		4.2	11.3	5.5					
Green Ext Time (p_c), s	0.0	3.9	0.6		0.0	3.3	0.9					

Intersection Summary

HCM 6th Ctrl Delay	19.7
HCM 6th LOS	B





















Notes

\* HCM 6th computational engine requires equal clearance times for the phases crossing the barrier.  
 Unsignalized Delay for [NBR, SBR] is excluded from calculations of the approach delay and intersection delay.



HCM 6th Signalized Intersection Summary  
1: SR-86 & W Keystone Rd

Near Term PM  
03/30/2023

												
Movement	EBL	EBT	EBR	WBL	WBT	WBR	NBL	NBT	NBR	SBL	SBT	SBR
Lane Configurations												
Traffic Volume (veh/h)	34	34	18	80	36	52	23	438	23	32	451	22
Future Volume (veh/h)	34	34	18	80	36	52	23	438	23	32	451	22
Initial Q (Qb), veh	0	0	0	0	0	0	0	0	0	0	0	0
Ped-Bike Adj(A_pbT)	1.00		1.00	1.00		1.00	1.00		1.00	1.00		1.00
Parking Bus, Adj	1.00	1.00	1.00	1.00	1.00	1.00	1.00	1.00	1.00	1.00	1.00	1.00
Work Zone On Approach		No			No			No			No	
Adj Sat Flow, veh/h/ln	1752	1752	1752	1752	1752	1752	1752	1752	1752	1752	1752	1752
Adj Flow Rate, veh/h	44	44	23	138	62	90	25	476	25	37	524	26
Peak Hour Factor	0.77	0.77	0.77	0.58	0.58	0.58	0.92	0.92	0.92	0.86	0.86	0.86
Percent Heavy Veh, %	10	10	10	10	10	10	10	10	10	10	10	10
Cap, veh/h	202	183	77	248	100	114	77	952	425	104	1007	449
Arrive On Green	0.25	0.25	0.25	0.25	0.25	0.25	0.05	0.29	0.29	0.06	0.30	0.30
Sat Flow, veh/h	450	729	308	613	397	454	1668	3328	1485	1668	3328	1485
Grp Volume(v), veh/h	111	0	0	290	0	0	25	476	25	37	524	26
Grp Sat Flow(s),veh/h/ln	1487	0	0	1464	0	0	1668	1664	1485	1668	1664	1485
Q Serve(g_s), s	0.0	0.0	0.0	7.3	0.0	0.0	0.8	6.7	0.7	1.2	7.4	0.7
Cycle Q Clear(g_c), s	3.0	0.0	0.0	10.2	0.0	0.0	0.8	6.7	0.7	1.2	7.4	0.7
Prop In Lane	0.40		0.21	0.48		0.31	1.00		1.00	1.00		1.00
Lane Grp Cap(c), veh/h	463	0	0	462	0	0	77	952	425	104	1007	449
V/C Ratio(X)	0.24	0.00	0.00	0.63	0.00	0.00	0.33	0.50	0.06	0.36	0.52	0.06
Avail Cap(c_a), veh/h	1146	0	0	1142	0	0	245	1923	858	245	1923	858
HCM Platoon Ratio	1.00	1.00	1.00	1.00	1.00	1.00	1.00	1.00	1.00	1.00	1.00	1.00
Upstream Filter(I)	1.00	0.00	0.00	1.00	0.00	0.00	1.00	1.00	1.00	1.00	1.00	1.00
Uniform Delay (d), s/veh	16.9	0.0	0.0	19.5	0.0	0.0	26.1	16.8	14.6	25.4	16.3	14.0
Incr Delay (d2), s/veh	0.3	0.0	0.0	1.4	0.0	0.0	0.9	1.5	0.2	0.8	1.5	0.2
Initial Q Delay(d3),s/veh	0.0	0.0	0.0	0.0	0.0	0.0	0.0	0.0	0.0	0.0	0.0	0.0
%ile BackOfQ(50%),veh/ln	1.1	0.0	0.0	3.4	0.0	0.0	0.3	2.3	0.2	0.4	2.5	0.2
Unsig. Movement Delay, s/veh												
LnGrp Delay(d),s/veh	17.2	0.0	0.0	20.9	0.0	0.0	27.0	18.3	14.8	26.1	17.8	14.2
LnGrp LOS	B	A	A	C	A	A	C	B	B	C	B	B
Approach Vol, veh/h		111			290			526			587	
Approach Delay, s/veh		17.2			20.9			18.5			18.2	
Approach LOS		B			C			B			B	
Timer - Assigned Phs	1	2		4	5	6		8				
Phs Duration (G+Y+Rc), s	9.2	24.5		22.7	8.3	25.5		22.7				
Change Period (Y+Rc), s	* 5.7	* 8.4		8.5	* 5.7	* 8.4		8.5				
Max Green Setting (Gmax), s	* 8.3	* 33		41.5	* 8.3	* 33		41.5				
Max Q Clear Time (g_c+I1), s	3.2	8.7		5.0	2.8	9.4		12.2				
Green Ext Time (p_c), s	0.0	7.1		0.7	0.0	7.7		1.9				
<b>Intersection Summary</b>												
HCM 6th Ctrl Delay				18.7								
HCM 6th LOS				B								
<b>Notes</b>												
* HCM 6th computational engine requires equal clearance times for the phases crossing the barrier.												

Intersection

Intersection Delay, s/veh 11.4

Intersection LOS B

Movement	EBL	EBT	EBR	WBL	WBT	WBR	NBL	NBT	NBR	SBL	SBT	SBR
Lane Configurations		↕			↕			↕			↕	
Traffic Vol, veh/h	25	44	13	7	49	9	16	221	3	13	203	30
Future Vol, veh/h	25	44	13	7	49	9	16	221	3	13	203	30
Peak Hour Factor	0.73	0.73	0.73	0.94	0.94	0.94	0.76	0.76	0.76	0.70	0.79	0.79
Heavy Vehicles, %	10	10	10	10	10	10	10	10	10	10	10	10
Mvmt Flow	34	60	18	7	52	10	21	291	4	19	257	38
Number of Lanes	0	1	0	0	1	0	0	1	0	0	1	0

Approach	EB	WB	NB	SB
Opposing Approach	WB	EB	SB	NB
Opposing Lanes	1	1	1	1
Conflicting Approach Left	SB	NB	EB	WB
Conflicting Lanes Left	1	1	1	1
Conflicting Approach Right	NB	SB	WB	EB
Conflicting Lanes Right	1	1	1	1
HCM Control Delay	10	9.6	11.9	11.7
HCM LOS	A	A	B	B

Lane	NBLn1	EBLn1	WBLn1	SBLn1
Vol Left, %	7%	30%	11%	5%
Vol Thru, %	92%	54%	75%	83%
Vol Right, %	1%	16%	14%	12%
Sign Control	Stop	Stop	Stop	Stop
Traffic Vol by Lane	240	82	65	246
LT Vol	16	25	7	13
Through Vol	221	44	49	203
RT Vol	3	13	9	30
Lane Flow Rate	316	112	69	314
Geometry Grp	1	1	1	1
Degree of Util (X)	0.435	0.179	0.112	0.427
Departure Headway (Hd)	4.959	5.751	5.816	4.898
Convergence, Y/N	Yes	Yes	Yes	Yes
Cap	717	627	620	727
Service Time	3.052	3.755	3.82	2.991
HCM Lane V/C Ratio	0.441	0.179	0.111	0.432
HCM Control Delay	11.9	10	9.6	11.7
HCM Lane LOS	B	A	A	B
HCM 95th-tile Q	2.2	0.6	0.4	2.1



HCM 6th Signalized Intersection Summary  
3: Hwy 111 & E Keystone Rd

Near Term PM  
03/30/2023



Movement	EBL	EBT	EBR	WBL	WBT	WBR	NBL	NBT	NBR	SBL	SBT	SBR
Lane Configurations		↕			↕		↗	↗	↗	↗	↗	↗
Traffic Volume (veh/h)	4	3	70	1	8	1	26	562	4	1	899	19
Future Volume (veh/h)	4	3	70	1	8	1	26	562	4	1	899	19
Initial Q (Qb), veh	0	0	0	0	0	0	0	0	0	0	0	0
Ped-Bike Adj(A_pbT)	1.00		1.00	1.00		1.00	1.00		1.00	1.00		1.00
Parking Bus, Adj	1.00	1.00	1.00	1.00	1.00	1.00	1.00	1.00	1.00	1.00	1.00	1.00
Work Zone On Approach		No			No			No			No	
Adj Sat Flow, veh/h/ln	1752	1752	1752	1752	1752	1752	1752	1752	1752	1752	1752	1752
Adj Flow Rate, veh/h	5	4	86	1	12	1	28	611	4	1	956	20
Peak Hour Factor	0.81	0.81	0.81	0.67	0.67	0.67	0.92	0.92	0.92	0.94	0.94	0.94
Percent Heavy Veh, %	10	10	10	10	10	10	10	10	10	10	10	10
Cap, veh/h	75	18	222	77	255	20	106	1446	645	5	1244	555
Arrive On Green	0.16	0.16	0.16	0.16	0.16	0.16	0.06	0.43	0.43	0.00	0.37	0.37
Sat Flow, veh/h	30	112	1356	34	1558	122	1668	3328	1485	1668	3328	1485
Grp Volume(v), veh/h	95	0	0	14	0	0	28	611	4	1	956	20
Grp Sat Flow(s),veh/h/ln	1498	0	0	1715	0	0	1668	1664	1485	1668	1664	1485
Q Serve(g_s), s	0.0	0.0	0.0	0.0	0.0	0.0	0.9	6.9	0.1	0.0	13.7	0.5
Cycle Q Clear(g_c), s	3.0	0.0	0.0	0.4	0.0	0.0	0.9	6.9	0.1	0.0	13.7	0.5
Prop In Lane	0.05		0.91	0.07		0.07	1.00		1.00	1.00		1.00
Lane Grp Cap(c), veh/h	315	0	0	352	0	0	106	1446	645	5	1244	555
V/C Ratio(X)	0.30	0.00	0.00	0.04	0.00	0.00	0.26	0.42	0.01	0.22	0.77	0.04
Avail Cap(c_a), veh/h	1470	0	0	1658	0	0	308	1685	751	308	1685	751
HCM Platoon Ratio	1.00	1.00	1.00	1.00	1.00	1.00	1.00	1.00	1.00	1.00	1.00	1.00
Upstream Filter(I)	1.00	0.00	0.00	1.00	0.00	0.00	1.00	1.00	1.00	1.00	1.00	1.00
Uniform Delay (d), s/veh	20.2	0.0	0.0	19.1	0.0	0.0	24.1	10.6	8.7	26.9	14.9	10.8
Incr Delay (d2), s/veh	0.5	0.0	0.0	0.0	0.0	0.0	1.3	0.2	0.0	22.1	1.5	0.0
Initial Q Delay(d3),s/veh	0.0	0.0	0.0	0.0	0.0	0.0	0.0	0.0	0.0	0.0	0.0	0.0
%ile BackOfQ(50%),veh/ln	0.0	0.0	0.0	0.1	0.0	0.0	0.3	1.7	0.0	0.0	3.9	0.1
Unsig. Movement Delay, s/veh												
LnGrp Delay(d),s/veh	20.7	0.0	0.0	19.1	0.0	0.0	25.5	10.8	8.7	49.0	16.4	10.8
LnGrp LOS	C	A	A	B	A	A	C	B	A	D	B	B
Approach Vol, veh/h		95			14			643			977	
Approach Delay, s/veh		20.7			19.1			11.4			16.3	
Approach LOS		C			B			B			B	
Timer - Assigned Phs	1	2		4	5	6		8				
Phs Duration (G+Y+Rc), s	5.8	31.9		16.4	9.1	28.6		16.4				
Change Period (Y+Rc), s	5.7	* 8.4		7.5	* 5.7	* 8.4		7.5				
Max Green Setting (Gmax), s	10	* 27		51.0	* 10	* 27		51.0				
Max Q Clear Time (g_c+I), s	10	8.9		5.0	2.9	15.7		2.4				
Green Ext Time (p_c), s	0.0	3.4		0.6	0.0	4.6		0.0				

Intersection Summary

HCM 6th Ctrl Delay	14.8
HCM 6th LOS	B

Notes

\* HCM 6th computational engine requires equal clearance times for the phases crossing the barrier.



Intersection						
Int Delay, s/veh	0					
Movement	WBL	WBR	NBT	NBR	SBL	SBT
Lane Configurations		↗	↗↗			↗↗
Traffic Vol, veh/h	0	0	484	0	0	549
Future Vol, veh/h	0	0	484	0	0	549
Conflicting Peds, #/hr	0	0	0	0	0	0
Sign Control	Stop	Stop	Free	Free	Free	Free
RT Channelized	-	None	-	None	-	None
Storage Length	-	0	-	-	-	-
Veh in Median Storage, #	0	-	0	-	-	0
Grade, %	0	-	0	-	-	0
Peak Hour Factor	92	92	92	92	92	92
Heavy Vehicles, %	10	10	10	10	10	10
Mvmt Flow	0	0	526	0	0	597

Major/Minor	Minor1	Major1	Major2
Conflicting Flow All	-	263	0
Stage 1	-	-	-
Stage 2	-	-	-
Critical Hdwy	-	7.1	-
Critical Hdwy Stg 1	-	-	-
Critical Hdwy Stg 2	-	-	-
Follow-up Hdwy	-	3.4	-
Pot Cap-1 Maneuver	0	712	0
Stage 1	0	-	0
Stage 2	0	-	0
Platoon blocked, %	-	-	-
Mov Cap-1 Maneuver	-	712	-
Mov Cap-2 Maneuver	-	-	-
Stage 1	-	-	-
Stage 2	-	-	-

Approach	WB	NB	SB
HCM Control Delay, s	0	0	0
HCM LOS	A		

Minor Lane/Major Mvmt	NBTWBLn1	SBT
Capacity (veh/h)	-	-
HCM Lane V/C Ratio	-	-
HCM Control Delay (s)	-	0
HCM Lane LOS	-	A
HCM 95th %tile Q(veh)	-	-

Intersection						
Int Delay, s/veh	0					
Movement	WBL	WBR	NBT	NBR	SBL	SBT
Lane Configurations		↗	↕↗			↕↗
Traffic Vol, veh/h	0	0	484	0	0	549
Future Vol, veh/h	0	0	484	0	0	549
Conflicting Peds, #/hr	0	0	0	0	0	0
Sign Control	Stop	Stop	Free	Free	Free	Free
RT Channelized	-	None	-	None	-	None
Storage Length	-	0	-	-	-	-
Veh in Median Storage, #	0	-	0	-	-	0
Grade, %	0	-	0	-	-	0
Peak Hour Factor	92	92	92	92	92	92
Heavy Vehicles, %	10	10	10	10	10	10
Mvmt Flow	0	0	526	0	0	597

Major/Minor	Minor1	Major1	Major2		
Conflicting Flow All	-	263	0	0	-
Stage 1	-	-	-	-	-
Stage 2	-	-	-	-	-
Critical Hdwy	-	7.1	-	-	-
Critical Hdwy Stg 1	-	-	-	-	-
Critical Hdwy Stg 2	-	-	-	-	-
Follow-up Hdwy	-	3.4	-	-	-
Pot Cap-1 Maneuver	0	712	-	-	0
Stage 1	0	-	-	-	0
Stage 2	0	-	-	-	0
Platoon blocked, %			-	-	-
Mov Cap-1 Maneuver	-	712	-	-	-
Mov Cap-2 Maneuver	-	-	-	-	-
Stage 1	-	-	-	-	-
Stage 2	-	-	-	-	-

Approach	WB	NB	SB
HCM Control Delay, s	0	0	0
HCM LOS	A		

Minor Lane/Major Mvmt	NBT	NBRWBLn1	SBT
Capacity (veh/h)	-	-	-
HCM Lane V/C Ratio	-	-	-
HCM Control Delay (s)	-	-	0
HCM Lane LOS	-	-	A
HCM 95th %tile Q(veh)	-	-	-



**Intersection**

Int Delay, s/veh 0.9

Movement	EBL	EBT	EBR	WBL	WBT	WBR	NBL	NBT	NBR	SBL	SBT	SBR
Lane Configurations		↕			↕			↕			↕	
Traffic Vol, veh/h	0	5	0	6	6	7	0	515	1	13	640	0
Future Vol, veh/h	0	5	0	6	6	7	0	515	1	13	640	0
Conflicting Peds, #/hr	0	0	0	0	0	0	0	0	0	0	0	0
Sign Control	Stop	Stop	Stop	Stop	Stop	Stop	Free	Free	Free	Free	Free	Free
RT Channelized	-	-	None	-	-	None	-	-	None	-	-	None
Storage Length	-	-	-	-	-	-	-	-	-	-	-	-
Veh in Median Storage, #	-	0	-	-	0	-	-	0	-	-	0	-
Grade, %	-	0	-	-	0	-	-	0	-	-	0	-
Peak Hour Factor	92	92	92	58	58	58	93	93	93	82	82	82
Heavy Vehicles, %	10	10	10	10	10	10	10	10	10	10	10	10
Mvmt Flow	0	5	0	10	10	12	0	554	1	16	780	0

Major/Minor	Minor2	Minor1	Major1	Major2
Conflicting Flow All	1094	1367	390	980
Stage 1	812	812	-	555
Stage 2	282	555	-	425
Critical Hdwy	7.7	6.7	7.1	7.7
Critical Hdwy Stg 1	6.7	5.7	-	6.7
Critical Hdwy Stg 2	6.7	5.7	-	6.7
Follow-up Hdwy	3.6	4.1	3.4	3.6
Pot Cap-1 Maneuver	158	136	587	193
Stage 1	322	372	-	464
Stage 2	679	492	-	557
Platoon blocked, %				
Mov Cap-1 Maneuver	143	132	587	183
Mov Cap-2 Maneuver	143	132	-	183
Stage 1	322	361	-	464
Stage 2	653	492	-	533

Approach	EB	WB	NB	SB
HCM Control Delay, s	33.4	24.7	0	0.3
HCM LOS	D	C		

Minor Lane/Major Mvmt	NBL	NBT	NBR	EBLn1	WBLn1	SBL	SBT	SBR
Capacity (veh/h)	783	-	-	132	215	958	-	-
HCM Lane V/C Ratio	-	-	-	0.041	0.152	0.017	-	-
HCM Control Delay (s)	0	-	-	33.4	24.7	8.8	0.1	-
HCM Lane LOS	A	-	-	D	C	A	A	-
HCM 95th %tile Q(veh)	0	-	-	0.1	0.5	0.1	-	-

Intersection												
Int Delay, s/veh	1.9											
Movement	EBL	EBT	EBR	WBL	WBT	WBR	NBL	NBT	NBR	SBL	SBT	SBR
Lane Configurations		↕			↕			↕			↕	
Traffic Vol, veh/h	2	20	7	8	17	6	2	198	4	7	245	3
Future Vol, veh/h	2	20	7	8	17	6	2	198	4	7	245	3
Conflicting Peds, #/hr	0	0	0	0	0	0	0	0	0	0	0	0
Sign Control	Stop	Stop	Stop	Stop	Stop	Stop	Free	Free	Free	Free	Free	Free
RT Channelized	-	-	None	-	-	None	-	-	None	-	-	None
Storage Length	-	-	-	-	-	-	-	-	-	-	-	-
Veh in Median Storage, #	-	0	-	-	0	-	-	0	-	-	0	-
Grade, %	-	0	-	-	0	-	-	0	-	-	0	-
Peak Hour Factor	67	67	67	75	75	75	76	76	76	78	78	78
Heavy Vehicles, %	10	10	10	10	10	10	10	10	10	10	10	10
Mvmt Flow	3	30	10	11	23	8	3	261	5	9	314	4

Major/Minor	Minor2		Minor1		Major1			Major2				
Conflicting Flow All	619	606	316	624	606	264	318	0	0	266	0	0
Stage 1	334	334	-	270	270	-	-	-	-	-	-	-
Stage 2	285	272	-	354	336	-	-	-	-	-	-	-
Critical Hdwy	7.2	6.6	6.3	7.2	6.6	6.3	4.2	-	-	4.2	-	-
Critical Hdwy Stg 1	6.2	5.6	-	6.2	5.6	-	-	-	-	-	-	-
Critical Hdwy Stg 2	6.2	5.6	-	6.2	5.6	-	-	-	-	-	-	-
Follow-up Hdwy	3.59	4.09	3.39	3.59	4.09	3.39	2.29	-	-	2.29	-	-
Pot Cap-1 Maneuver	390	401	706	387	401	756	1198	-	-	1253	-	-
Stage 1	663	629	-	718	672	-	-	-	-	-	-	-
Stage 2	705	670	-	647	628	-	-	-	-	-	-	-
Platoon blocked, %								-	-	-	-	-
Mov Cap-1 Maneuver	366	396	706	356	396	756	1198	-	-	1253	-	-
Mov Cap-2 Maneuver	366	396	-	356	396	-	-	-	-	-	-	-
Stage 1	661	623	-	716	670	-	-	-	-	-	-	-
Stage 2	672	668	-	601	622	-	-	-	-	-	-	-

Approach	EB		WB		NB		SB	
HCM Control Delay, s	14.1		14.4		0.1		0.2	
HCM LOS	B		B					

Minor Lane/Major Mvmt	NBL	NBT	NBR	EBLn1	WBLn1	SBL	SBT	SBR
Capacity (veh/h)	1198	-	-	440	423	1253	-	-
HCM Lane V/C Ratio	0.002	-	-	0.098	0.098	0.007	-	-
HCM Control Delay (s)	8	0	-	14.1	14.4	7.9	0	-
HCM Lane LOS	A	A	-	B	B	A	A	-
HCM 95th %tile Q(veh)	0	-	-	0.3	0.3	0	-	-



Intersection												
Int Delay, s/veh	2.6											
Movement	EBL	EBT	EBR	WBL	WBT	WBR	NBL	NBT	NBR	SBL	SBT	SBR
Lane Configurations		↕			↕		↗	↗	↗	↗	↗	↗
Traffic Vol, veh/h	11	13	25	2	11	0	17	530	0	1	890	13
Future Vol, veh/h	11	13	25	2	11	0	17	530	0	1	890	13
Conflicting Peds, #/hr	0	0	0	0	0	0	0	0	0	0	0	0
Sign Control	Stop	Stop	Stop	Stop	Stop	Stop	Free	Free	Free	Free	Free	Free
RT Channelized	-	-	None	-	-	None	-	-	Free	-	-	Free
Storage Length	-	-	-	-	-	-	515	-	515	520	-	480
Veh in Median Storage, #	-	0	-	-	0	-	-	0	-	-	0	-
Grade, %	-	0	-	-	0	-	-	0	-	-	0	-
Peak Hour Factor	67	67	67	69	69	69	92	92	92	91	91	91
Heavy Vehicles, %	10	10	10	10	10	10	10	10	10	10	10	10
Mvmt Flow	16	19	37	3	16	0	18	576	0	1	978	14

Major/Minor	Minor2		Minor1		Major1		Major2					
Conflicting Flow All	1312	1592	489	1113	1592	288	978	0	-	576	0	0
Stage 1	980	980	-	612	612	-	-	-	-	-	-	-
Stage 2	332	612	-	501	980	-	-	-	-	-	-	-
Critical Hdwy	7.7	6.7	7.1	7.7	6.7	7.1	4.3	-	-	4.3	-	-
Critical Hdwy Stg 1	6.7	5.7	-	6.7	5.7	-	-	-	-	-	-	-
Critical Hdwy Stg 2	6.7	5.7	-	6.7	5.7	-	-	-	-	-	-	-
Follow-up Hdwy	3.6	4.1	3.4	3.6	4.1	3.4	2.3	-	-	2.3	-	-
Pot Cap-1 Maneuver	109	98	504	153	98	685	654	-	0	940	-	0
Stage 1	253	309	-	428	463	-	-	-	0	-	-	0
Stage 2	634	463	-	500	309	-	-	-	0	-	-	0
Platoon blocked, %												
Mov Cap-1 Maneuver	93	95	504	117	95	685	654	-	-	940	-	-
Mov Cap-2 Maneuver	93	95	-	117	95	-	-	-	-	-	-	-
Stage 1	246	309	-	416	450	-	-	-	-	-	-	-
Stage 2	595	450	-	433	309	-	-	-	-	-	-	-























Approach	EB		WB		NB		SB	
HCM Control Delay, s	44.7		50.3		0.3		0	
HCM LOS	E		F					

Minor Lane/Major Mvmt	NBL	NBT	EBLn1	WBLn1	SBL	SBT
Capacity (veh/h)	654	-	161	98	940	-
HCM Lane V/C Ratio	0.028	-	0.454	0.192	0.001	-
HCM Control Delay (s)	10.7	-	44.7	50.3	8.8	-
HCM Lane LOS	B	-	E	F	A	-
HCM 95th %tile Q(veh)	0.1	-	2.1	0.7	0	-



HCM 6th Signalized Intersection Summary  
 9: SR-86 & Worthington Rd/E Barioni Blvd

Near Term PM  
 03/30/2023

												
Movement	EBL	EBT	EBR	WBL	WBT	WBR	NBL	NBT	NBR	SBL	SBT	SBR
Lane Configurations												
Traffic Volume (veh/h)	55	115	192	125	101	44	106	811	35	47	848	49
Future Volume (veh/h)	55	115	192	125	101	44	106	811	35	47	848	49
Initial Q (Qb), veh	0	0	0	0	0	0	0	0	0	0	0	0
Ped-Bike Adj(A_pbT)	1.00		0.98	1.00		0.98	1.00		0.99	1.00		0.99
Parking Bus, Adj	1.00	1.00	1.00	1.00	1.00	1.00	1.00	1.00	1.00	1.00	1.00	1.00
Work Zone On Approach		No			No			No			No	
Adj Sat Flow, veh/h/ln	1752	1752	1752	1752	1752	1752	1752	1752	1752	1752	1752	1752
Adj Flow Rate, veh/h	74	155	259	154	125	54	120	922	40	55	998	58
Peak Hour Factor	0.74	0.74	0.74	0.81	0.81	0.81	0.88	0.88	0.88	0.85	0.85	0.85
Percent Heavy Veh, %	10	10	10	10	10	10	10	10	10	10	10	10
Cap, veh/h	111	233	291	178	144	275	143	1183	51	70	1024	60
Arrive On Green	0.20	0.20	0.20	0.19	0.19	0.19	0.09	0.36	0.36	0.04	0.32	0.32
Sat Flow, veh/h	557	1167	1458	941	764	1456	1668	3248	141	1668	3195	186
Grp Volume(v), veh/h	229	0	259	279	0	54	120	472	490	55	520	536
Grp Sat Flow(s),veh/h/ln	1724	0	1458	1705	0	1456	1668	1664	1725	1668	1664	1716
Q Serve(g_s), s	10.7	0.0	15.2	13.9	0.0	2.7	6.2	22.1	22.1	2.9	27.1	27.1
Cycle Q Clear(g_c), s	10.7	0.0	15.2	13.9	0.0	2.7	6.2	22.1	22.1	2.9	27.1	27.1
Prop In Lane	0.32		1.00	0.55		1.00	1.00		0.08	1.00		0.11
Lane Grp Cap(c), veh/h	344	0	291	322	0	275	143	606	628	70	533	550
V/C Ratio(X)	0.67	0.00	0.89	0.87	0.00	0.20	0.84	0.78	0.78	0.78	0.97	0.97
Avail Cap(c_a), veh/h	356	0	301	356	0	304	143	606	628	101	533	550
HCM Platoon Ratio	1.00	1.00	1.00	1.00	1.00	1.00	1.00	1.00	1.00	1.00	1.00	1.00
Upstream Filter(I)	1.00	0.00	1.00	1.00	0.00	1.00	1.00	1.00	1.00	1.00	1.00	1.00
Uniform Delay (d), s/veh	32.4	0.0	34.1	34.5	0.0	29.9	39.5	24.8	24.8	41.6	29.4	29.4
Incr Delay (d2), s/veh	4.5	0.0	25.8	18.3	0.0	0.3	33.9	6.5	6.2	21.7	32.4	31.8
Initial Q Delay(d3),s/veh	0.0	0.0	0.0	0.0	0.0	0.0	0.0	0.0	0.0	0.0	0.0	0.0
%ile BackOfQ(50%),veh/ln	4.8	0.0	7.3	7.3	0.0	1.0	3.8	8.9	9.2	1.5	14.6	15.0
Unsig. Movement Delay, s/veh												
LnGrp Delay(d),s/veh	36.8	0.0	59.9	52.8	0.0	30.3	73.4	31.2	31.0	63.3	61.8	61.2
LnGrp LOS	D	A	E	D	A	C	E	C	C	E	E	E
Approach Vol, veh/h		488			333			1082			1111	
Approach Delay, s/veh		49.1			49.1			35.8			61.6	
Approach LOS		D			D			D			E	
Timer - Assigned Phs	1	2		4	5	6		8				
Phs Duration (G+Y+Rc), s	8.2	36.4		22.0	12.0	32.6		21.1				
Change Period (Y+Rc), s	4.5	4.5		4.5	4.5	4.5		4.5				
Max Green Setting (Gmax), s	5.3	30.3		18.1	7.5	28.1		18.3				
Max Q Clear Time (g_c+l1), s	4.9	24.1		17.2	8.2	29.1		15.9				
Green Ext Time (p_c), s	0.0	2.9		0.2	0.0	0.0		0.4				
<b>Intersection Summary</b>												
HCM 6th Ctrl Delay			48.9									
HCM 6th LOS			D									

Intersection

Intersection Delay, s/veh 12.4

Intersection LOS B

Movement	EBL	EBT	EBR	WBL	WBT	WBR	NBL	NBT	NBR	SBL	SBT	SBR
Lane Configurations		↕			↕			↕			↕	
Traffic Vol, veh/h	12	107	52	11	112	14	52	212	9	12	226	24
Future Vol, veh/h	12	107	52	11	112	14	52	212	9	12	226	24
Peak Hour Factor	0.91	0.91	0.91	0.78	0.78	0.78	0.95	0.95	0.95	0.97	0.97	0.97
Heavy Vehicles, %	10	10	10	10	10	10	10	10	10	10	10	10
Mvmt Flow	13	118	57	14	144	18	55	223	9	12	233	25
Number of Lanes	0	1	0	0	1	0	0	1	0	0	1	0

Approach	EB	WB	NB	SB
Opposing Approach	WB	EB	SB	NB
Opposing Lanes	1	1	1	1
Conflicting Approach Left	SB	NB	EB	WB
Conflicting Lanes Left	1	1	1	1
Conflicting Approach Right	NB	SB	WB	EB
Conflicting Lanes Right	1	1	1	1
HCM Control Delay	11.4	11.5	13.3	12.7
HCM LOS	B	B	B	B

Lane	NBLn1	EBLn1	WBLn1	SBLn1
Vol Left, %	19%	7%	8%	5%
Vol Thru, %	78%	63%	82%	86%
Vol Right, %	3%	30%	10%	9%
Sign Control	Stop	Stop	Stop	Stop
Traffic Vol by Lane	273	171	137	262
LT Vol	52	12	11	12
Through Vol	212	107	112	226
RT Vol	9	52	14	24
Lane Flow Rate	287	188	176	270
Geometry Grp	1	1	1	1
Degree of Util (X)	0.45	0.304	0.291	0.42
Departure Headway (Hd)	5.632	5.817	5.958	5.601
Convergence, Y/N	Yes	Yes	Yes	Yes
Cap	638	614	601	640
Service Time	3.691	3.882	4.025	3.661
HCM Lane V/C Ratio	0.45	0.306	0.293	0.422
HCM Control Delay	13.3	11.4	11.5	12.7
HCM Lane LOS	B	B	B	B
HCM 95th-tile Q	2.3	1.3	1.2	2.1



HCM 6th Signalized Intersection Summary  
 11: Hwy 111 & Worthington Rd/E. Worthington Rd

Near Term PM  
 03/30/2023



Movement	EBL	EBT	EBR	WBL	WBT	WBR	NBL	NBT	NBR	SBL	SBT	SBR
Lane Configurations		↕			↕		↗	↗	↗	↗	↗	↗
Traffic Volume (veh/h)	19	55	73	13	51	14	35	519	23	13	840	34
Future Volume (veh/h)	19	55	73	13	51	14	35	519	23	13	840	34
Initial Q (Qb), veh	0	0	0	0	0	0	0	0	0	0	0	0
Ped-Bike Adj(A_pbT)	1.00		1.00	1.00		1.00	1.00		1.00	1.00		1.00
Parking Bus, Adj	1.00	1.00	1.00	1.00	1.00	1.00	1.00	1.00	1.00	1.00	1.00	1.00
Work Zone On Approach		No			No			No			No	
Adj Sat Flow, veh/h/ln	1870	1870	1870	1870	1870	1870	1870	1870	1870	1870	1870	1870
Adj Flow Rate, veh/h	23	65	87	16	65	18	37	546	0	15	977	0
Peak Hour Factor	0.84	0.84	0.84	0.79	0.78	0.78	0.95	0.95	0.95	0.86	0.86	0.86
Percent Heavy Veh, %	2	2	2	2	2	2	2	2	2	2	2	2
Cap, veh/h	118	160	183	124	286	70	177	1515		81	1325	
Arrive On Green	0.22	0.22	0.22	0.22	0.22	0.22	0.10	0.43	0.00	0.05	0.37	0.00
Sat Flow, veh/h	113	728	832	128	1302	318	1781	3554	1585	1781	3554	1585
Grp Volume(v), veh/h	175	0	0	99	0	0	37	546	0	15	977	0
Grp Sat Flow(s),veh/h/ln	1673	0	0	1747	0	0	1781	1777	1585	1781	1777	1585
Q Serve(g_s), s	0.0	0.0	0.0	0.0	0.0	0.0	0.8	4.6	0.0	0.4	10.4	0.0
Cycle Q Clear(g_c), s	3.9	0.0	0.0	2.0	0.0	0.0	0.8	4.6	0.0	0.4	10.4	0.0
Prop In Lane	0.13		0.50	0.16		0.18	1.00		1.00	1.00		1.00
Lane Grp Cap(c), veh/h	461	0	0	480	0	0	177	1515		81	1325	
V/C Ratio(X)	0.38	0.00	0.00	0.21	0.00	0.00	0.21	0.36		0.18	0.74	
Avail Cap(c_a), veh/h	772	0	0	799	0	0	488	1743		488	1743	
HCM Platoon Ratio	1.00	1.00	1.00	1.00	1.00	1.00	1.00	1.00	1.00	1.00	1.00	1.00
Upstream Filter(I)	1.00	0.00	0.00	1.00	0.00	0.00	1.00	1.00	0.00	1.00	1.00	0.00
Uniform Delay (d), s/veh	14.9	0.0	0.0	14.1	0.0	0.0	18.2	8.5	0.0	20.1	11.9	0.0
Incr Delay (d2), s/veh	0.5	0.0	0.0	0.2	0.0	0.0	0.6	0.1	0.0	1.1	1.2	0.0
Initial Q Delay(d3),s/veh	0.0	0.0	0.0	0.0	0.0	0.0	0.0	0.0	0.0	0.0	0.0	0.0
%ile BackOfQ(50%),veh/ln	1.4	0.0	0.0	0.7	0.0	0.0	0.3	1.0	0.0	0.1	2.6	0.0
Unsig. Movement Delay, s/veh												
LnGrp Delay(d),s/veh	15.4	0.0	0.0	14.3	0.0	0.0	18.7	8.7	0.0	21.2	13.1	0.0
LnGrp LOS	B	A	A	B	A	A	B	A		C	B	
Approach Vol, veh/h		175			99			583			992	
Approach Delay, s/veh		15.4			14.3			9.3			13.2	
Approach LOS		B			B			A			B	
Timer - Assigned Phs	1	2		4	5	6		8				
Phs Duration (G+Y+Rc), s	6.5	23.2		14.1	8.9	20.8		14.1				
Change Period (Y+Rc), s	4.5	4.5		4.5	4.5	4.5		4.5				
Max Green Setting (Gmax), s	21.5	21.5		18.0	12.0	21.5		18.0				
Max Q Clear Time (g_c+I), s	6.6	6.6		5.9	2.8	12.4		4.0				
Green Ext Time (p_c), s	0.0	2.7		0.7	0.0	3.9		0.4				

Intersection Summary

HCM 6th Ctrl Delay	12.2
HCM 6th LOS	B

Notes

Unsignalized Delay for [NBR, SBR] is excluded from calculations of the approach delay and intersection delay.

**APPENDIX D**  
**INTERSECTION ANALYSIS WORKSHEETS – OPENING YEAR +  
PROJECT**

HCM 6th Signalized Intersection Summary  
1: SR-86 & W Keystone Rd

Near Term + Project AM  
04/11/2023



Movement	EBL	EBT	EBR	WBL	WBT	WBR	NBL	NBT	NBR	SBL	SBT	SBR
Lane Configurations		↔			↔		↗	↗	↗	↗	↗	↗
Traffic Volume (veh/h)	51	62	15	27	45	45	35	459	69	45	467	32
Future Volume (veh/h)	51	62	15	27	45	45	35	459	69	45	467	32
Initial Q (Qb), veh	0	0	0	0	0	0	0	0	0	0	0	0
Ped-Bike Adj(A_pbT)	1.00		1.00	1.00		1.00	1.00		1.00	1.00		1.00
Parking Bus, Adj	1.00	1.00	1.00	1.00	1.00	1.00	1.00	1.00	1.00	1.00	1.00	1.00
Work Zone On Approach		No			No			No			No	
Adj Sat Flow, veh/h/ln	1752	1752	1752	1752	1752	1752	1752	1752	1752	1752	1752	1752
Adj Flow Rate, veh/h	59	71	17	54	82	82	44	574	86	61	631	43
Peak Hour Factor	0.87	0.87	0.87	0.50	0.55	0.55	0.80	0.80	0.80	0.74	0.74	0.74
Percent Heavy Veh, %	10	10	10	10	10	10	10	10	10	10	10	10
Cap, veh/h	174	174	34	130	131	110	117	1103	492	145	1158	517
Arrive On Green	0.19	0.19	0.19	0.19	0.19	0.19	0.07	0.33	0.33	0.09	0.35	0.35
Sat Flow, veh/h	458	932	182	278	700	590	1668	3328	1485	1668	3328	1485
Grp Volume(v), veh/h	147	0	0	218	0	0	44	574	86	61	631	43
Grp Sat Flow(s),veh/h/ln	1571	0	0	1568	0	0	1668	1664	1485	1668	1664	1485
Q Serve(g_s), s	0.0	0.0	0.0	2.8	0.0	0.0	1.4	8.0	2.4	2.0	8.7	1.1
Cycle Q Clear(g_c), s	4.5	0.0	0.0	7.3	0.0	0.0	1.4	8.0	2.4	2.0	8.7	1.1
Prop In Lane	0.40		0.12	0.25		0.38	1.00		1.00	1.00		1.00
Lane Grp Cap(c), veh/h	382	0	0	372	0	0	117	1103	492	145	1158	517
V/C Ratio(X)	0.38	0.00	0.00	0.59	0.00	0.00	0.38	0.52	0.17	0.42	0.54	0.08
Avail Cap(c_a), veh/h	1145	0	0	1174	0	0	242	1831	817	274	1895	845
HCM Platoon Ratio	1.00	1.00	1.00	1.00	1.00	1.00	1.00	1.00	1.00	1.00	1.00	1.00
Upstream Filter(I)	1.00	0.00	0.00	1.00	0.00	0.00	1.00	1.00	1.00	1.00	1.00	1.00
Uniform Delay (d), s/veh	20.7	0.0	0.0	21.8	0.0	0.0	25.4	15.5	13.6	24.8	15.0	12.5
Incr Delay (d2), s/veh	0.6	0.0	0.0	1.5	0.0	0.0	0.7	1.4	0.6	0.7	1.5	0.2
Initial Q Delay(d3),s/veh	0.0	0.0	0.0	0.0	0.0	0.0	0.0	0.0	0.0	0.0	0.0	0.0
%ile BackOfQ(50%),veh/ln	1.7	0.0	0.0	2.7	0.0	0.0	0.5	2.7	0.7	0.7	2.9	0.3
Unsig. Movement Delay, s/veh												
LnGrp Delay(d),s/veh	21.3	0.0	0.0	23.3	0.0	0.0	26.2	16.8	14.2	25.5	16.5	12.8
LnGrp LOS	C	A	A	C	A	A	C	B	B	C	B	B
Approach Vol, veh/h		147			218			704			735	
Approach Delay, s/veh		21.3			23.3			17.1			17.0	
Approach LOS		C			C			B			B	
Timer - Assigned Phs	1	2		4	5	6		8				
Phs Duration (G+Y+Rc), s	10.7	27.4		19.2	9.7	28.3		19.2				
Change Period (Y+Rc), s	* 5.7	* 8.4		8.5	* 5.7	* 8.4		8.5				
Max Green Setting (Gmax), s	* 9.4	* 32		41.5	* 8.3	* 33		41.5				
Max Q Clear Time (g_c+I1), s	4.0	10.0		6.5	3.4	10.7		9.3				
Green Ext Time (p_c), s	0.0	8.7		0.9	0.0	9.2		1.4				

Intersection Summary		
HCM 6th Ctrl Delay		18.2
HCM 6th LOS		B

Notes

\* HCM 6th computational engine requires equal clearance times for the phases crossing the barrier.



**Intersection**

Intersection Delay, s/veh 9.3

Intersection LOS A

Movement	EBL	EBT	EBR	WBL	WBT	WBR	NBL	NBT	NBR	SBL	SBT	SBR
Lane Configurations		↕			↕			↕			↕	
Traffic Vol, veh/h	19	46	44	5	47	13	23	103	4	10	158	19
Future Vol, veh/h	19	46	44	5	47	13	23	103	4	10	158	19
Peak Hour Factor	0.86	0.86	0.86	0.67	0.67	0.67	0.86	0.86	0.86	0.86	0.86	0.86
Heavy Vehicles, %	10	10	10	10	10	10	10	10	10	10	10	10
Mvmt Flow	22	53	51	7	70	19	27	120	5	12	184	22
Number of Lanes	0	1	0	0	1	0	0	1	0	0	1	0

Approach	EB	WB	NB	SB
Opposing Approach	WB	EB	SB	NB
Opposing Lanes	1	1	1	1
Conflicting Approach Left SB		NB	EB	WB
Conflicting Lanes Left	1	1	1	1
Conflicting Approach Right NB		SB	WB	EB
Conflicting Lanes Right	1	1	1	1
HCM Control Delay	9	8.9	9.2	9.7
HCM LOS	A	A	A	A

Lane	NBLn1	EBLn1	WBLn1	SBLn1
Vol Left, %	18%	17%	8%	5%
Vol Thru, %	79%	42%	72%	84%
Vol Right, %	3%	40%	20%	10%
Sign Control	Stop	Stop	Stop	Stop
Traffic Vol by Lane	130	109	65	187
LT Vol	23	19	5	10
Through Vol	103	46	47	158
RT Vol	4	44	13	19
Lane Flow Rate	151	127	97	217
Geometry Grp	1	1	1	1
Degree of Util (X)	0.206	0.172	0.135	0.288
Departure Headway (Hd)	4.906	4.881	5.022	4.762
Convergence, Y/N	Yes	Yes	Yes	Yes
Cap	729	731	710	752
Service Time	2.959	2.939	3.083	2.81
HCM Lane V/C Ratio	0.207	0.174	0.137	0.289
HCM Control Delay	9.2	9	8.9	9.7
HCM Lane LOS	A	A	A	A
HCM 95th-tile Q	0.8	0.6	0.5	1.2

HCM 6th Signalized Intersection Summary  
3: Hwy 111 & E Keystone Rd

Near Term + Project AM  
04/11/2023



Movement	EBL	EBT	EBR	WBL	WBT	WBR	NBL	NBT	NBR	SBL	SBT	SBR
Lane Configurations		↕			↕		↗	↗	↗	↗	↗	↗
Traffic Volume (veh/h)	14	10	51	0	9	1	63	609	2	2	629	4
Future Volume (veh/h)	14	10	51	0	9	1	63	609	2	2	629	4
Initial Q (Qb), veh	0	0	0	0	0	0	0	0	0	0	0	0
Ped-Bike Adj(A_pbT)	1.00		1.00	1.00		1.00	1.00		1.00	1.00		1.00
Parking Bus, Adj	1.00	1.00	1.00	1.00	1.00	1.00	1.00	1.00	1.00	1.00	1.00	1.00
Work Zone On Approach	No			No			No			No		
Adj Sat Flow, veh/h/ln	1752	1752	1752	1752	1752	1752	1752	1752	1752	1752	1752	1752
Adj Flow Rate, veh/h	17	12	62	0	16	2	70	677	2	2	749	5
Peak Hour Factor	0.82	0.82	0.82	0.58	0.58	0.58	0.90	0.90	0.90	0.84	0.84	0.84
Percent Heavy Veh, %	10	10	10	10	10	10	10	10	10	10	10	10
Cap, veh/h	104	56	170	0	252	31	202	1417	632	9	1033	461
Arrive On Green	0.16	0.16	0.16	0.00	0.16	0.16	0.12	0.43	0.43	0.01	0.31	0.31
Sat Flow, veh/h	146	337	1033	0	1527	191	1668	3328	1485	1668	3328	1485
Grp Volume(v), veh/h	91	0	0	0	0	18	70	677	2	2	749	5
Grp Sat Flow(s),veh/h/ln1516		0	0	0	0	1717	1668	1664	1485	1668	1664	1485
Q Serve(g_s), s	0.0	0.0	0.0	0.0	0.0	0.5	2.1	7.8	0.0	0.1	10.7	0.1
Cycle Q Clear(g_c), s	2.8	0.0	0.0	0.0	0.0	0.5	2.1	7.8	0.0	0.1	10.7	0.1
Prop In Lane	0.19		0.68	0.00		0.11	1.00		1.00	1.00		1.00
Lane Grp Cap(c), veh/h	330	0	0	0	0	283	202	1417	632	9	1033	461
V/C Ratio(X)	0.28	0.00	0.00	0.00	0.00	0.06	0.35	0.48	0.00	0.22	0.73	0.01
Avail Cap(c_a), veh/h	1494	0	0	0	0	1638	312	1705	761	312	1705	761
HCM Platoon Ratio	1.00	1.00	1.00	1.00	1.00	1.00	1.00	1.00	1.00	1.00	1.00	1.00
Upstream Filter(I)	1.00	0.00	0.00	0.00	0.00	1.00	1.00	1.00	1.00	1.00	1.00	1.00
Uniform Delay (d), s/veh	19.8	0.0	0.0	0.0	0.0	18.8	21.6	11.1	8.8	26.5	16.4	12.8
Incr Delay (d2), s/veh	0.4	0.0	0.0	0.0	0.0	0.1	1.0	0.3	0.0	11.6	1.0	0.0
Initial Q Delay(d3),s/veh	0.0	0.0	0.0	0.0	0.0	0.0	0.0	0.0	0.0	0.0	0.0	0.0
%ile BackOfQ(50%),veh/ln	0.0	0.0	0.0	0.0	0.0	0.2	0.7	2.0	0.0	0.1	3.1	0.0
Unsig. Movement Delay, s/veh												
LnGrp Delay(d),s/veh	20.2	0.0	0.0	0.0	0.0	18.9	22.6	11.3	8.8	38.0	17.4	12.8
LnGrp LOS	C	A	A	A	A	B	C	B	A	D	B	B
Approach Vol, veh/h	91		18				749				756	
Approach Delay, s/veh	20.2		18.9				12.4				17.4	
Approach LOS	C		B				B				B	
Timer - Assigned Phs	1	2	4		5	6	8					
Phs Duration (G+Y+Rc), s6.0	31.2		16.3	12.2	25.0		16.3					
Change Period (Y+Rc), s 5.7	* 8.4		7.5	* 5.7	* 8.4		7.5					
Max Green Setting (Gmax)6	* 27		51.0	* 10	* 27		51.0					
Max Q Clear Time (g_c+I_Q, s	9.8		4.8	4.1	12.7		2.5					
Green Ext Time (p_c), s	0.0	3.7		0.6	0.1	3.9		0.1				

Intersection Summary

HCM 6th Ctrl Delay	15.3
HCM 6th LOS	B

Notes

\* HCM 6th computational engine requires equal clearance times for the phases crossing the barrier.



**Intersection**

Int Delay, s/veh 0.3

Movement	WBL	WBR	NBT	NBR	SBL	SBT
Lane Configurations		↗	↗↗			↗↗
Traffic Vol, veh/h	0	31	532	0	0	509
Future Vol, veh/h	0	31	532	0	0	509
Conflicting Peds, #/hr	0	0	0	0	0	0
Sign Control	Stop	Stop	Free	Free	Free	Free
RT Channelized	-	None	-	None	-	None
Storage Length	-	0	-	-	-	-
Veh in Median Storage, #	0	-	0	-	-	0
Grade, %	0	-	0	-	-	0
Peak Hour Factor	92	92	92	92	92	92
Heavy Vehicles, %	10	10	10	10	10	10
Mvmt Flow	0	34	578	0	0	553

Major/Minor	Minor1	Major1	Major2
Conflicting Flow All	-	289	0
Stage 1	-	-	-
Stage 2	-	-	-
Critical Hdwy	-	7.1	-
Critical Hdwy Stg 1	-	-	-
Critical Hdwy Stg 2	-	-	-
Follow-up Hdwy	-	3.4	-
Pot Cap-1 Maneuver	0	684	0
Stage 1	0	-	0
Stage 2	0	-	0
Platoon blocked, %	-	-	-
Mov Cap-1 Maneuver	-	684	-
Mov Cap-2 Maneuver	-	-	-
Stage 1	-	-	-
Stage 2	-	-	-

Approach	WB	NB	SB
HCM Control Delay, s	10.5	0	0
HCM LOS	B		

Minor Lane/Major Mvmt	NBTWBLn1	SBT
Capacity (veh/h)	- 684	-
HCM Lane V/C Ratio	- 0.049	-
HCM Control Delay (s)	- 10.5	-
HCM Lane LOS	- B	-
HCM 95th %tile Q(veh)	- 0.2	-

Intersection						
Int Delay, s/veh	0					
Movement	WBL	WBR	NBT	NBR	SBL	SBT
Lane Configurations		↗	↕			↕
Traffic Vol, veh/h	0	0	532	42	0	509
Future Vol, veh/h	0	0	532	42	0	509
Conflicting Peds, #/hr	0	0	0	0	0	0
Sign Control	Stop	Stop	Free	Free	Free	Free
RT Channelized	-	None	-	None	-	None
Storage Length	-	0	-	-	-	-
Veh in Median Storage, #	0	-	0	-	-	0
Grade, %	0	-	0	-	-	0
Peak Hour Factor	92	92	92	92	92	92
Heavy Vehicles, %	10	10	10	10	10	10
Mvmt Flow	0	0	578	46	0	553

Major/Minor	Minor1	Major1	Major2		
Conflicting Flow All	-	312	0	0	-
Stage 1	-	-	-	-	-
Stage 2	-	-	-	-	-
Critical Hdwy	-	7.1	-	-	-
Critical Hdwy Stg 1	-	-	-	-	-
Critical Hdwy Stg 2	-	-	-	-	-
Follow-up Hdwy	-	3.4	-	-	-
Pot Cap-1 Maneuver	0	661	-	-	0
Stage 1	0	-	-	-	0
Stage 2	0	-	-	-	0
Platoon blocked, %			-	-	-
Mov Cap-1 Maneuver	-	661	-	-	-
Mov Cap-2 Maneuver	-	-	-	-	-
Stage 1	-	-	-	-	-
Stage 2	-	-	-	-	-

Approach	WB	NB	SB
HCM Control Delay, s	0	0	0
HCM LOS	A		

Minor Lane/Major Mvmt	NBT	NBRWBLn1	SBT
Capacity (veh/h)	-	-	-
HCM Lane V/C Ratio	-	-	-
HCM Control Delay (s)	-	-	0
HCM Lane LOS	-	-	A
HCM 95th %tile Q(veh)	-	-	-



**Intersection**

Int Delay, s/veh 1.1

Movement	EBL	EBT	EBR	WBL	WBT	WBR	NBL	NBT	NBR	SBL	SBT	SBR
Lane Configurations		↕			↕			↕			↕	
Traffic Vol, veh/h	0	4	0	2	5	55	0	564	4	6	510	0
Future Vol, veh/h	0	4	0	2	5	55	0	564	4	6	510	0
Conflicting Peds, #/hr	0	0	0	0	0	0	0	0	0	0	0	0
Sign Control	Stop	Stop	Stop	Stop	Stop	Stop	Free	Free	Free	Free	Free	Free
RT Channelized	-	-	None	-	-	None	-	-	None	-	-	None
Storage Length	-	-	-	-	-	-	-	-	-	-	-	-
Veh in Median Storage, #	-	0	-	-	0	-	-	0	-	-	0	-
Grade, %	-	0	-	-	0	-	-	0	-	-	0	-
Peak Hour Factor	92	92	92	68	68	68	83	83	83	80	80	80
Heavy Vehicles, %	10	10	10	10	10	10	10	10	10	10	10	10
Mvmt Flow	0	4	0	3	7	81	0	680	5	8	638	0

Major/Minor	Minor2	Minor1	Major1	Major2
Conflicting Flow All	998	1339	319	1020
Stage 1	654	654	-	683
Stage 2	344	685	-	337
Critical Hdwy	7.7	6.7	7.1	7.7
Critical Hdwy Stg 1	6.7	5.7	-	6.7
Critical Hdwy Stg 2	6.7	5.7	-	6.7
Follow-up Hdwy	3.6	4.1	3.4	3.6
Pot Cap-1 Maneuver	187	142	654	180
Stage 1	403	442	-	387
Stage 2	623	428	-	629
Platoon blocked, %				
Mov Cap-1 Maneuver	155	140	654	174
Mov Cap-2 Maneuver	155	140	-	174
Stage 1	403	435	-	387
Stage 2	534	428	-	613

Approach	EB	WB	NB	SB
HCM Control Delay, s	31.5	14.7	0	0.2
HCM LOS	D	B		

Minor Lane/Major Mvmt	NBL	NBT	NBR	EBLn1	WBLn1	SBL	SBT	SBR
Capacity (veh/h)	889	-	-	140	461	853	-	-
HCM Lane V/C Ratio	-	-	-	0.031	0.198	0.009	-	-
HCM Control Delay (s)	0	-	-	31.5	14.7	9.3	0.1	-
HCM Lane LOS	A	-	-	D	B	A	A	-
HCM 95th %tile Q(veh)	0	-	-	0.1	0.7	0	-	-

Intersection												
Int Delay, s/veh	2.3											
Movement	EBL	EBT	EBR	WBL	WBT	WBR	NBL	NBT	NBR	SBL	SBT	SBR
Lane Configurations		↕			↕			↕			↕	
Traffic Vol, veh/h	4	9	3	6	25	9	19	164	6	5	235	21
Future Vol, veh/h	4	9	3	6	25	9	19	164	6	5	235	21
Conflicting Peds, #/hr	0	0	0	0	0	0	0	0	0	0	0	0
Sign Control	Stop	Stop	Stop	Stop	Stop	Stop	Free	Free	Free	Free	Free	Free
RT Channelized	-	-	None	-	-	None	-	-	None	-	-	None
Storage Length	-	-	-	-	-	-	-	-	-	-	-	-
Veh in Median Storage, #	-	0	-	-	0	-	-	0	-	-	0	-
Grade, %	-	0	-	-	0	-	-	0	-	-	0	-
Peak Hour Factor	60	60	60	64	64	64	76	76	76	76	76	76
Heavy Vehicles, %	10	10	10	10	10	10	10	10	10	10	10	10
Mvmt Flow	7	15	5	9	39	14	25	216	8	7	309	28

Major/Minor	Minor2		Minor1		Major1			Major2				
Conflicting Flow All	634	611	323	617	621	220	337	0	0	224	0	0
Stage 1	337	337	-	270	270	-	-	-	-	-	-	-
Stage 2	297	274	-	347	351	-	-	-	-	-	-	-
Critical Hdwy	7.2	6.6	6.3	7.2	6.6	6.3	4.2	-	-	4.2	-	-
Critical Hdwy Stg 1	6.2	5.6	-	6.2	5.6	-	-	-	-	-	-	-
Critical Hdwy Stg 2	6.2	5.6	-	6.2	5.6	-	-	-	-	-	-	-
Follow-up Hdwy	3.59	4.09	3.39	3.59	4.09	3.39	2.29	-	-	2.29	-	-
Pot Cap-1 Maneuver	381	398	700	391	393	800	1179	-	-	1299	-	-
Stage 1	661	627	-	718	672	-	-	-	-	-	-	-
Stage 2	695	669	-	653	618	-	-	-	-	-	-	-
Platoon blocked, %								-	-	-	-	-
Mov Cap-1 Maneuver	337	386	700	368	381	800	1179	-	-	1299	-	-
Mov Cap-2 Maneuver	337	386	-	368	381	-	-	-	-	-	-	-
Stage 1	645	623	-	701	656	-	-	-	-	-	-	-
Stage 2	627	653	-	628	614	-	-	-	-	-	-	-

Approach	EB	WB	NB	SB
HCM Control Delay, s	14.5	14.8	0.8	0.1
HCM LOS	B	B		

Minor Lane/Major Mvmt	NBL	NBT	NBR	EBLn1WBLn1	SBL	SBT	SBR
Capacity (veh/h)	1179	-	-	405	429	1299	-
HCM Lane V/C Ratio	0.021	-	-	0.066	0.146	0.005	-
HCM Control Delay (s)	8.1	0	-	14.5	14.8	7.8	0
HCM Lane LOS	A	A	-	B	B	A	A
HCM 95th %tile Q(veh)	0.1	-	-	0.2	0.5	0	-



**Intersection**

Int Delay, s/veh 2.8

Movement	EBL	EBT	EBR	WBL	WBT	WBR	NBL	NBT	NBR	SBL	SBT	SBR
Lane Configurations		↕			↕		↗	↗	↗	↗	↗	↗
Traffic Vol, veh/h	13	6	11	3	9	2	41	601	2	1	608	14
Future Vol, veh/h	13	6	11	3	9	2	41	601	2	1	608	14
Conflicting Peds, #/hr	0	0	0	0	0	0	0	0	0	0	0	0
Sign Control	Stop	Stop	Stop	Stop	Stop	Stop	Free	Free	Free	Free	Free	Free
RT Channelized	-	-	None	-	-	None	-	-	Free	-	-	Free
Storage Length	-	-	-	-	-	-	515	-	515	520	-	480
Veh in Median Storage, #	-	0	-	-	0	-	-	0	-	-	0	-
Grade, %	-	0	-	-	0	-	-	0	-	-	0	-
Peak Hour Factor	50	50	50	42	42	42	86	86	86	88	88	88
Heavy Vehicles, %	10	10	10	10	10	10	10	10	10	10	10	10
Mvmt Flow	26	12	22	7	21	5	48	699	2	1	691	16

Major/Minor	Minor2		Minor1		Major1			Major2				
Conflicting Flow All	1149	1488	346	1149	1488	350	691	0	-	699	0	0
Stage 1	693	693	-	795	795	-	-	-	-	-	-	-
Stage 2	456	795	-	354	693	-	-	-	-	-	-	-
Critical Hdwy	7.7	6.7	7.1	7.7	6.7	7.1	4.3	-	-	4.3	-	-
Critical Hdwy Stg 1	6.7	5.7	-	6.7	5.7	-	-	-	-	-	-	-
Critical Hdwy Stg 2	6.7	5.7	-	6.7	5.7	-	-	-	-	-	-	-
Follow-up Hdwy	3.6	4.1	3.4	3.6	4.1	3.4	2.3	-	-	2.3	-	-
Pot Cap-1 Maneuver	144	114	627	144	114	624	848	-	0	842	-	0
Stage 1	382	424	-	330	379	-	-	-	0	-	-	0
Stage 2	533	379	-	614	424	-	-	-	0	-	-	0
Platoon blocked, %								-			-	
Mov Cap-1 Maneuver	116	107	627	122	107	624	848	-	-	842	-	-
Mov Cap-2 Maneuver	116	107	-	122	107	-	-	-	-	-	-	-
Stage 1	360	424	-	311	357	-	-	-	-	-	-	-
Stage 2	469	357	-	575	424	-	-	-	-	-	-	-

Approach	EB	WB	NB	SB
HCM Control Delay, s	39.7	44	0.6	0
HCM LOS	E	E		

Minor Lane/Major Mvmt	NBL	NBT	EBLn1	WBLn1	SBL	SBT
Capacity (veh/h)	848	-	162	125	842	-
HCM Lane V/C Ratio	0.056	-	0.37	0.267	0.001	-
HCM Control Delay (s)	9.5	-	39.7	44	9.3	-
HCM Lane LOS	A	-	E	E	A	-
HCM 95th %tile Q(veh)	0.2	-	1.6	1	0	-

HCM 6th Signalized Intersection Summary  
 9: SR-86 & Worthington Rd/E Barioni Blvd

Near Term + Project AM  
 04/11/2023



Movement	EBL	EBT	EBR	WBL	WBT	WBR	NBL	NBT	NBR	SBL	SBT	SBR
Lane Configurations		↕	↗		↖	↗	↖	↕		↖	↕	↗
Traffic Volume (veh/h)	83	113	233	119	80	45	131	682	72	51	786	41
Future Volume (veh/h)	83	113	233	119	80	45	131	682	72	51	786	41
Initial Q (Qb), veh	0	0	0	0	0	0	0	0	0	0	0	0
Ped-Bike Adj(A_pbT)	1.00		1.00	1.00		0.99	1.00		1.00	1.00		1.00
Parking Bus, Adj	1.00	1.00	1.00	1.00	1.00	1.00	1.00	1.00	1.00	1.00	1.00	1.00
Work Zone On Approach		No			No			No			No	
Adj Sat Flow, veh/h/ln	1752	1752	1752	1752	1752	1752	1752	1752	1752	1752	1752	1752
Adj Flow Rate, veh/h	95	130	268	142	95	54	158	822	87	61	936	49
Peak Hour Factor	0.87	0.87	0.87	0.84	0.84	0.84	0.83	0.83	0.83	0.84	0.84	0.84
Percent Heavy Veh, %	10	10	10	10	10	10	10	10	10	10	10	10
Cap, veh/h	147	202	301	170	114	247	182	1132	120	76	995	52
Arrive On Green	0.20	0.20	0.20	0.17	0.17	0.17	0.11	0.37	0.37	0.05	0.31	0.31
Sat Flow, veh/h	724	991	1478	1019	682	1477	1668	3036	321	1668	3217	168
Grp Volume(v), veh/h	225	0	268	237	0	54	158	451	458	61	484	501
Grp Sat Flow(s),veh/h/ln	1716	0	1478	1701	0	1477	1668	1664	1693	1668	1664	1721
Q Serve(g_s), s	10.3	0.0	15.0	11.5	0.0	2.7	7.9	19.9	19.9	3.1	24.2	24.2
Cycle Q Clear(g_c), s	10.3	0.0	15.0	11.5	0.0	2.7	7.9	19.9	19.9	3.1	24.2	24.2
Prop In Lane	0.42		1.00	0.60		1.00	1.00		0.19	1.00		0.10
Lane Grp Cap(c), veh/h	349	0	301	284	0	247	182	620	631	76	515	532
V/C Ratio(X)	0.64	0.00	0.89	0.83	0.00	0.22	0.87	0.73	0.73	0.80	0.94	0.94
Avail Cap(c_a), veh/h	364	0	314	361	0	313	182	620	631	112	517	535
HCM Platoon Ratio	1.00	1.00	1.00	1.00	1.00	1.00	1.00	1.00	1.00	1.00	1.00	1.00
Upstream Filter(I)	1.00	0.00	1.00	1.00	0.00	1.00	1.00	1.00	1.00	1.00	1.00	1.00
Uniform Delay (d), s/veh	31.1	0.0	33.0	34.4	0.0	30.7	37.4	23.0	23.0	40.3	28.7	28.7
Incr Delay (d2), s/veh	3.7	0.0	25.0	12.6	0.0	0.4	33.1	4.3	4.2	22.1	25.5	25.0
Initial Q Delay(d3),s/veh	0.0	0.0	0.0	0.0	0.0	0.0	0.0	0.0	0.0	0.0	0.0	0.0
%ile BackOfQ(50%),veh/ln	4.5	0.0	7.3	5.6	0.0	1.0	4.7	7.7	7.8	1.7	12.4	12.7
Unsig. Movement Delay, s/veh												
LnGrp Delay(d),s/veh	34.8	0.0	58.1	46.9	0.0	31.1	70.5	27.3	27.2	62.4	54.2	53.6
LnGrp LOS	C	A	E	D	A	C	E	C	C	E	D	D
Approach Vol, veh/h		493			291			1067			1046	
Approach Delay, s/veh		47.4			44.0			33.6			54.4	
Approach LOS		D			D			C			D	
Timer - Assigned Phs	1	2		4	5	6		8				
Phs Duration (G+Y+Rc), s	8.4	36.3		21.8	13.8	30.9		18.7				
Change Period (Y+Rc), s	4.5	4.5		4.5	4.5	4.5		4.5				
Max Green Setting (Gmax), s	5.7	30.1		18.1	9.3	26.5		18.1				
Max Q Clear Time (g_c+I1), s	5.1	21.9		17.0	9.9	26.2		13.5				
Green Ext Time (p_c), s	0.0	3.3		0.3	0.0	0.2		0.6				

Intersection Summary

HCM 6th Ctrl Delay	44.5
HCM 6th LOS	D

Notes

User approved pedestrian interval to be less than phase max green.



**Intersection**

Intersection Delay, s/veh 14.2  
Intersection LOS B

Movement	EBL	EBT	EBR	WBL	WBT	WBR	NBL	NBT	NBR	SBL	SBT	SBR
Lane Configurations		↕			↕			↕			↕	
Traffic Vol, veh/h	12	141	57	3	140	12	47	150	7	34	217	21
Future Vol, veh/h	12	141	57	3	140	12	47	150	7	34	217	21
Peak Hour Factor	0.86	0.86	0.86	0.73	0.73	0.73	0.93	0.93	0.93	0.80	0.80	0.80
Heavy Vehicles, %	10	10	10	10	10	10	10	10	10	10	10	10
Mvmt Flow	14	164	66	4	192	16	51	161	8	43	271	26
Number of Lanes	0	1	0	0	1	0	0	1	0	0	1	0

Approach	EB	WB	NB	SB
Opposing Approach	WB	EB	SB	NB
Opposing Lanes	1	1	1	1
Conflicting Approach Left	SB	NB	EB	WB
Conflicting Lanes Left	1	1	1	1
Conflicting Approach Right	NB	SB	WB	EB
Conflicting Lanes Right	1	1	1	1
HCM Control Delay	13.4	13	13.1	16.2
HCM LOS	B	B	B	C

Lane	NBLn1	EBLn1	WBLn1	SBLn1
Vol Left, %	23%	6%	2%	12%
Vol Thru, %	74%	67%	90%	80%
Vol Right, %	3%	27%	8%	8%
Sign Control	Stop	Stop	Stop	Stop
Traffic Vol by Lane	204	210	155	272
LT Vol	47	12	3	34
Through Vol	150	141	140	217
RT Vol	7	57	12	21
Lane Flow Rate	219	244	212	340
Geometry Grp	1	1	1	1
Degree of Util (X)	0.381	0.416	0.371	0.554
Departure Headway (Hd)	6.254	6.128	6.293	5.992
Convergence, Y/N	Yes	Yes	Yes	Yes
Cap	577	591	573	605
Service Time	4.269	4.141	4.317	3.992
HCM Lane V/C Ratio	0.38	0.413	0.37	0.562
HCM Control Delay	13.1	13.4	13	16.2
HCM Lane LOS	B	B	B	C
HCM 95th-tile Q	1.8	2	1.7	3.4

HCM 6th Signalized Intersection Summary  
11: Hwy 111 & E. Worthington Rd

Near Term + Project AM  
04/11/2023



Movement	EBL	EBT	EBR	WBL	WBT	WBR	NBL	NBT	NBR	SBL	SBT	SBR
Lane Configurations		↕			↕		↗	↗	↗	↗	↗	↗
Traffic Volume (veh/h)	17	47	101	13	73	14	70	611	7	9	555	46
Future Volume (veh/h)	17	47	101	13	73	14	70	611	7	9	555	46
Initial Q (Qb), veh	0	0	0	0	0	0	0	0	0	0	0	0
Ped-Bike Adj(A_pbT)	1.00		1.00	1.00		1.00	1.00		1.00	1.00		1.00
Parking Bus, Adj	1.00	1.00	1.00	1.00	1.00	1.00	1.00	1.00	1.00	1.00	1.00	1.00
Work Zone On Approach		No			No			No			No	
Adj Sat Flow, veh/h/ln	1870	1870	1870	1870	1870	1870	1870	1870	1870	1870	1870	1870
Adj Flow Rate, veh/h	22	60	129	17	96	18	82	719	0	11	653	0
Peak Hour Factor	0.78	0.78	0.78	0.76	0.76	0.76	0.85	0.85	0.85	0.85	0.85	0.85
Percent Heavy Veh, %	2	2	2	2	2	2	2	2	2	2	2	2
Cap, veh/h	88	97	180	94	255	44	276	1360		60	929	
Arrive On Green	0.18	0.18	0.18	0.18	0.18	0.18	0.15	0.38	0.00	0.03	0.26	0.00
Sat Flow, veh/h	93	546	1006	117	1428	246	1781	3554	1585	1781	3554	1585
Grp Volume(v), veh/h	211	0	0	131	0	0	82	719	0	11	653	0
Grp Sat Flow(s),veh/h/ln	1646	0	0	1791	0	0	1781	1777	1585	1781	1777	1585
Q Serve(g_s), s	2.2	0.0	0.0	0.0	0.0	0.0	2.3	8.7	0.0	0.3	9.3	0.0
Cycle Q Clear(g_c), s	6.7	0.0	0.0	3.5	0.0	0.0	2.3	8.7	0.0	0.3	9.3	0.0
Prop In Lane	0.10		0.61	0.13		0.14	1.00		1.00	1.00		1.00
Lane Grp Cap(c), veh/h	365	0	0	392	0	0	276	1360		60	929	
V/C Ratio(X)	0.58	0.00	0.00	0.33	0.00	0.00	0.30	0.53		0.18	0.70	
Avail Cap(c_a), veh/h	482	0	0	516	0	0	383	1360		383	1045	
HCM Platoon Ratio	1.00	1.00	1.00	1.00	1.00	1.00	1.00	1.00	1.00	1.00	1.00	1.00
Upstream Filter(I)	1.00	0.00	0.00	1.00	0.00	0.00	1.00	1.00	0.00	1.00	1.00	0.00
Uniform Delay (d), s/veh	21.5	0.0	0.0	20.3	0.0	0.0	20.9	13.3	0.0	26.2	18.6	0.0
Incr Delay (d2), s/veh	1.8	0.0	0.0	2.3	0.0	0.0	0.2	1.5	0.0	0.5	4.4	0.0
Initial Q Delay(d3),s/veh	0.0	0.0	0.0	0.0	0.0	0.0	0.0	0.0	0.0	0.0	0.0	0.0
%ile BackOfQ(50%),veh/ln	2.6	0.0	0.0	1.6	0.0	0.0	0.8	2.8	0.0	0.1	3.5	0.0
Unsig. Movement Delay, s/veh												
LnGrp Delay(d),s/veh	23.3	0.0	0.0	22.6	0.0	0.0	21.1	14.8	0.0	26.7	23.1	0.0
LnGrp LOS	C	A	A	C	A	A	C	B		C	C	
Approach Vol, veh/h		211			131			801			664	
Approach Delay, s/veh		23.3			22.6			15.4			23.1	
Approach LOS		C			C			B			C	
Timer - Assigned Phs	1	2		4	5	6		8				
Phs Duration (G+Y+Rc), s	7.6	29.7		18.4	14.3	23.0		18.4				
Change Period (Y+Rc), s	5.7	* 8.4		8.5	* 5.7	* 8.4		8.5				
Max Green Setting (Gmax), s	16	* 16		14.0	* 12	* 16		14.0				
Max Q Clear Time (g_c+I), s	10.7	10.7		8.7	4.3	11.3		5.5				
Green Ext Time (p_c), s	0.0	3.9		0.6	0.0	3.3		1.0				

Intersection Summary

HCM 6th Ctrl Delay	19.7
HCM 6th LOS	B





















Notes

\* HCM 6th computational engine requires equal clearance times for the phases crossing the barrier.  
Unsignalized Delay for [NBR, SBR] is excluded from calculations of the approach delay and intersection delay.



HCM 6th Signalized Intersection Summary  
1: SR-86 & W Keystone Rd

Near Term + Project PM  
04/11/2023

												
Movement	EBL	EBT	EBR	WBL	WBT	WBR	NBL	NBT	NBR	SBL	SBT	SBR
Lane Configurations												
Traffic Volume (veh/h)	34	46	18	80	36	52	36	443	47	35	451	22
Future Volume (veh/h)	34	46	18	80	36	52	36	443	47	35	451	22
Initial Q (Qb), veh	0	0	0	0	0	0	0	0	0	0	0	0
Ped-Bike Adj(A_pbT)	1.00		1.00	1.00		1.00	1.00		1.00	1.00		1.00
Parking Bus, Adj	1.00	1.00	1.00	1.00	1.00	1.00	1.00	1.00	1.00	1.00	1.00	1.00
Work Zone On Approach		No			No			No			No	
Adj Sat Flow, veh/h/ln	1752	1752	1752	1752	1752	1752	1752	1752	1752	1752	1752	1752
Adj Flow Rate, veh/h	44	60	23	138	62	90	39	482	51	41	524	26
Peak Hour Factor	0.77	0.77	0.77	0.58	0.58	0.58	0.92	0.92	0.92	0.86	0.86	0.86
Percent Heavy Veh, %	10	10	10	10	10	10	10	10	10	10	10	10
Cap, veh/h	179	217	69	245	98	113	107	983	438	111	991	442
Arrive On Green	0.25	0.25	0.25	0.25	0.25	0.25	0.06	0.30	0.30	0.07	0.30	0.30
Sat Flow, veh/h	385	870	278	617	394	455	1668	3328	1485	1668	3328	1485
Grp Volume(v), veh/h	127	0	0	290	0	0	39	482	51	41	524	26
Grp Sat Flow(s),veh/h/ln	1532	0	0	1466	0	0	1668	1664	1485	1668	1664	1485
Q Serve(g_s), s	0.0	0.0	0.0	7.0	0.0	0.0	1.3	6.9	1.5	1.4	7.6	0.7
Cycle Q Clear(g_c), s	3.5	0.0	0.0	10.5	0.0	0.0	1.3	6.9	1.5	1.4	7.6	0.7
Prop In Lane	0.35		0.18	0.48		0.31	1.00		1.00	1.00		1.00
Lane Grp Cap(c), veh/h	465	0	0	456	0	0	107	983	438	111	991	442
V/C Ratio(X)	0.27	0.00	0.00	0.64	0.00	0.00	0.36	0.49	0.12	0.37	0.53	0.06
Avail Cap(c_a), veh/h	1139	0	0	1105	0	0	238	1868	833	238	1868	833
HCM Platoon Ratio	1.00	1.00	1.00	1.00	1.00	1.00	1.00	1.00	1.00	1.00	1.00	1.00
Upstream Filter(l)	1.00	0.00	0.00	1.00	0.00	0.00	1.00	1.00	1.00	1.00	1.00	1.00
Uniform Delay (d), s/veh	17.7	0.0	0.0	20.1	0.0	0.0	26.0	16.9	14.9	25.9	17.0	14.6
Incr Delay (d2), s/veh	0.3	0.0	0.0	1.5	0.0	0.0	0.8	1.4	0.4	0.8	1.6	0.2
Initial Q Delay(d3),s/veh	0.0	0.0	0.0	0.0	0.0	0.0	0.0	0.0	0.0	0.0	0.0	0.0
%ile BackOfQ(50%),veh/ln	1.3	0.0	0.0	3.5	0.0	0.0	0.5	2.4	0.5	0.5	2.6	0.2
Unsig. Movement Delay, s/veh												
LnGrp Delay(d),s/veh	18.0	0.0	0.0	21.6	0.0	0.0	26.8	18.2	15.4	26.7	18.6	14.8
LnGrp LOS	B	A	A	C	A	A	C	B	B	C	B	B
Approach Vol, veh/h		127			290			572			591	
Approach Delay, s/veh		18.0			21.6			18.6			19.0	
Approach LOS		B			C			B			B	
Timer - Assigned Phs	1	2		4	5	6		8				
Phs Duration (G+Y+Rc), s	9.6	25.5		23.0	9.4	25.7		23.0				
Change Period (Y+Rc), s	* 5.7	* 8.4		8.5	* 5.7	* 8.4		8.5				
Max Green Setting (Gmax), s	* 8.3	* 33		41.5	* 8.3	* 33		41.5				
Max Q Clear Time (g_c+1), s	3.4	8.9		5.5	3.3	9.6		12.5				
Green Ext Time (p_c), s	0.0	7.4		0.8	0.0	7.7		2.0				
<b>Intersection Summary</b>												
HCM 6th Ctrl Delay				19.2								
HCM 6th LOS				B								
<b>Notes</b>												
* HCM 6th computational engine requires equal clearance times for the phases crossing the barrier.												

<b>Intersection</b>												
Intersection Delay, s/veh	11.9											
Intersection LOS	B											

Movement	EBL	EBT	EBR	WBL	WBT	WBR	NBL	NBT	NBR	SBL	SBT	SBR
Lane Configurations	↕			↕			↕			↕		
Traffic Vol, veh/h	25	47	47	7	49	9	16	221	3	13	203	30
Future Vol, veh/h	25	47	47	7	49	9	16	221	3	13	203	30
Peak Hour Factor	0.73	0.73	0.73	0.94	0.94	0.94	0.76	0.76	0.76	0.70	0.79	0.79
Heavy Vehicles, %	10	10	10	10	10	10	10	10	10	10	10	10
Mvmt Flow	34	64	64	7	52	10	21	291	4	19	257	38
Number of Lanes	0	1	0	0	1	0	0	1	0	0	1	0

Approach	EB	WB	NB	SB
Opposing Approach	WB	EB	SB	NB
Opposing Lanes	1	1	1	1
Conflicting Approach Left	SB	NB	EB	WB
Conflicting Lanes Left	1	1	1	1
Conflicting Approach Right	NB	SB	WB	EB
Conflicting Lanes Right	1	1	1	1
HCM Control Delay	10.6	9.8	12.6	12.3
HCM LOS	B	A	B	B

Lane	NBLn1	EBLn1	WBLn1	SBLn1
Vol Left, %	7%	21%	11%	5%
Vol Thru, %	92%	39%	75%	83%
Vol Right, %	1%	39%	14%	12%
Sign Control	Stop	Stop	Stop	Stop
Traffic Vol by Lane	240	119	65	246
LT Vol	16	25	7	13
Through Vol	221	47	49	203
RT Vol	3	47	9	30
Lane Flow Rate	316	163	69	314
Geometry Grp	1	1	1	1
Degree of Util (X)	0.457	0.255	0.115	0.449
Departure Headway (Hd)	5.212	5.635	5.964	5.152
Convergence, Y/N	Yes	Yes	Yes	Yes
Cap	692	637	600	699
Service Time	3.242	3.673	4.008	3.181
HCM Lane V/C Ratio	0.457	0.256	0.115	0.449
HCM Control Delay	12.6	10.6	9.8	12.3
HCM Lane LOS	B	B	A	B
HCM 95th-tile Q	2.4	1	0.4	2.3



HCM 6th Signalized Intersection Summary  
3: Hwy 111 & E Keystone Rd

Near Term + Project PM  
04/11/2023



Movement	EBL	EBT	EBR	WBL	WBT	WBR	NBL	NBT	NBR	SBL	SBT	SBR
Lane Configurations		↔			↔		↗	↗	↗	↗	↗	↗
Traffic Volume (veh/h)	5	4	72	1	8	1	26	562	4	1	899	19
Future Volume (veh/h)	5	4	72	1	8	1	26	562	4	1	899	19
Initial Q (Qb), veh	0	0	0	0	0	0	0	0	0	0	0	0
Ped-Bike Adj(A_pbT)	1.00		1.00	1.00		1.00	1.00		1.00	1.00		1.00
Parking Bus, Adj	1.00	1.00	1.00	1.00	1.00	1.00	1.00	1.00	1.00	1.00	1.00	1.00
Work Zone On Approach	No			No			No			No		
Adj Sat Flow, veh/h/ln	1752	1752	1752	1752	1752	1752	1752	1752	1752	1752	1752	1752
Adj Flow Rate, veh/h	6	5	89	1	12	1	28	611	4	1	956	20
Peak Hour Factor	0.81	0.81	0.81	0.67	0.67	0.67	0.92	0.92	0.92	0.94	0.94	0.94
Percent Heavy Veh, %	10	10	10	10	10	10	10	10	10	10	10	10
Cap, veh/h	76	22	222	77	259	20	106	1444	644	5	1242	554
Arrive On Green	0.17	0.17	0.17	0.17	0.17	0.17	0.06	0.43	0.43	0.00	0.37	0.37
Sat Flow, veh/h	35	130	1335	34	1559	123	1668	3328	1485	1668	3328	1485
Grp Volume(v), veh/h	100	0	0	14	0	0	28	611	4	1	956	20
Grp Sat Flow(s),veh/h/ln1500	0	0	1715	0	0	1668	1664	1485	1668	1664	1485	
Q Serve(g_s), s	0.0	0.0	0.0	0.0	0.0	0.0	0.9	6.9	0.1	0.0	13.7	0.5
Cycle Q Clear(g_c), s	3.2	0.0	0.0	0.4	0.0	0.0	0.9	6.9	0.1	0.0	13.7	0.5
Prop In Lane	0.06		0.89	0.07		0.07	1.00		1.00	1.00		1.00
Lane Grp Cap(c), veh/h	319	0	0	356	0	0	106	1444	644	5	1242	554
V/C Ratio(X)	0.31	0.00	0.00	0.04	0.00	0.00	0.26	0.42	0.01	0.22	0.77	0.04
Avail Cap(c_a), veh/h	1465	0	0	1651	0	0	307	1677	748	307	1677	748
HCM Platoon Ratio	1.00	1.00	1.00	1.00	1.00	1.00	1.00	1.00	1.00	1.00	1.00	1.00
Upstream Filter(I)	1.00	0.00	0.00	1.00	0.00	0.00	1.00	1.00	1.00	1.00	1.00	1.00
Uniform Delay (d), s/veh	20.2	0.0	0.0	19.1	0.0	0.0	24.3	10.7	8.7	27.1	15.0	10.8
Incr Delay (d2), s/veh	0.6	0.0	0.0	0.0	0.0	0.0	1.3	0.2	0.0	22.1	1.6	0.0
Initial Q Delay(d3),s/veh	0.0	0.0	0.0	0.0	0.0	0.0	0.0	0.0	0.0	0.0	0.0	0.0
%ile BackOfQ(50%),veh/ln	1.1	0.0	0.0	0.1	0.0	0.0	0.3	1.7	0.0	0.0	3.9	0.1
Unsig. Movement Delay, s/veh												
LnGrp Delay(d),s/veh	20.8	0.0	0.0	19.1	0.0	0.0	25.6	10.9	8.7	49.2	16.5	10.9
LnGrp LOS	C	A	A	B	A	A	C	B	A	D	B	B
Approach Vol, veh/h	100			14			643			977		
Approach Delay, s/veh	20.8			19.1			11.5			16.5		
Approach LOS	C			B			B			B		
Timer - Assigned Phs	1	2		4	5	6		8				
Phs Duration (G+Y+Rc), s	5.8	32.0		16.5	9.1	28.7		16.5				
Change Period (Y+Rc), s	5.7	* 8.4		7.5	* 5.7	* 8.4		7.5				
Max Green Setting (Gmax), s	27	* 27		51.0	* 10	* 27		51.0				
Max Q Clear Time (g_c+I), s	8.9	8.9		5.2	2.9	15.7		2.4				
Green Ext Time (p_c), s	0.0	3.4		0.7	0.0	4.6		0.0				

Intersection Summary

HCM 6th Ctrl Delay	14.9
HCM 6th LOS	B

Notes

\* HCM 6th computational engine requires equal clearance times for the phases crossing the barrier.

Intersection						
Int Delay, s/veh	0.4					
Movement	WBL	WBR	NBT	NBR	SBL	SBT
Lane Configurations		↗	↗↗			↗↗
Traffic Vol, veh/h	0	42	484	0	0	549
Future Vol, veh/h	0	42	484	0	0	549
Conflicting Peds, #/hr	0	0	0	0	0	0
Sign Control	Stop	Stop	Free	Free	Free	Free
RT Channelized	-	None	-	None	-	None
Storage Length	-	0	-	-	-	-
Veh in Median Storage, #	0	-	0	-	-	0
Grade, %	0	-	0	-	-	0
Peak Hour Factor	92	92	92	92	92	92
Heavy Vehicles, %	10	10	10	10	10	10
Mvmt Flow	0	46	526	0	0	597

Major/Minor	Minor1	Major1	Major2		
Conflicting Flow All	-	263	0	-	-
Stage 1	-	-	-	-	-
Stage 2	-	-	-	-	-
Critical Hdwy	-	7.1	-	-	-
Critical Hdwy Stg 1	-	-	-	-	-
Critical Hdwy Stg 2	-	-	-	-	-
Follow-up Hdwy	-	3.4	-	-	-
Pot Cap-1 Maneuver	0	712	-	0	0
Stage 1	0	-	-	0	0
Stage 2	0	-	-	0	0
Platoon blocked, %					
Mov Cap-1 Maneuver	-	712	-	-	-
Mov Cap-2 Maneuver	-	-	-	-	-
Stage 1	-	-	-	-	-
Stage 2	-	-	-	-	-

Approach	WB	NB	SB
HCM Control Delay, s	10.4	0	0
HCM LOS	B		

Minor Lane/Major Mvmt	NBTWBLn1	SBT
Capacity (veh/h)	- 712	-
HCM Lane V/C Ratio	- 0.064	-
HCM Control Delay (s)	- 10.4	-
HCM Lane LOS	- B	-
HCM 95th %tile Q(veh)	- 0.2	-



**Intersection**

Int Delay, s/veh 0

Movement	WBL	WBR	NBT	NBR	SBL	SBT
Lane Configurations		↗	↕			↕
Traffic Vol, veh/h	0	0	484	31	0	549
Future Vol, veh/h	0	0	484	31	0	549
Conflicting Peds, #/hr	0	0	0	0	0	0
Sign Control	Stop	Stop	Free	Free	Free	Free
RT Channelized	-	None	-	None	-	None
Storage Length	-	0	-	-	-	-
Veh in Median Storage, #	0	-	0	-	-	0
Grade, %	0	-	0	-	-	0
Peak Hour Factor	92	92	92	92	92	92
Heavy Vehicles, %	10	10	10	10	10	10
Mvmt Flow	0	0	526	34	0	597

Major/Minor	Minor1	Major1	Major2
Conflicting Flow All	-	280	0
Stage 1	-	-	-
Stage 2	-	-	-
Critical Hdwy	-	7.1	-
Critical Hdwy Stg 1	-	-	-
Critical Hdwy Stg 2	-	-	-
Follow-up Hdwy	-	3.4	-
Pot Cap-1 Maneuver	0	694	0
Stage 1	0	-	0
Stage 2	0	-	0
Platoon blocked, %	-	-	-
Mov Cap-1 Maneuver	-	694	-
Mov Cap-2 Maneuver	-	-	-
Stage 1	-	-	-
Stage 2	-	-	-

Approach	WB	NB	SB
HCM Control Delay, s	0	0	0
HCM LOS	A		

Minor Lane/Major Mvmt	NBT	NBRWBLn1	SBT
Capacity (veh/h)	-	-	-
HCM Lane V/C Ratio	-	-	-
HCM Control Delay (s)	-	0	-
HCM Lane LOS	-	A	-
HCM 95th %tile Q(veh)	-	-	-

Intersection												
Int Delay, s/veh	1.3											
Movement	EBL	EBT	EBR	WBL	WBT	WBR	NBL	NBT	NBR	SBL	SBT	SBR
Lane Configurations		↕			↕			↕			↕	
Traffic Vol, veh/h	0	5	0	6	6	38	0	515	1	13	640	0
Future Vol, veh/h	0	5	0	6	6	38	0	515	1	13	640	0
Conflicting Peds, #/hr	0	0	0	0	0	0	0	0	0	0	0	0
Sign Control	Stop	Stop	Stop	Stop	Stop	Stop	Free	Free	Free	Free	Free	Free
RT Channelized	-	-	None	-	-	None	-	-	None	-	-	None
Storage Length	-	-	-	-	-	-	-	-	-	-	-	-
Veh in Median Storage, #	-	0	-	-	0	-	-	0	-	-	0	-
Grade, %	-	0	-	-	0	-	-	0	-	-	0	-
Peak Hour Factor	92	92	92	58	58	58	93	93	93	82	82	82
Heavy Vehicles, %	10	10	10	10	10	10	10	10	10	10	10	10
Mvmt Flow	0	5	0	10	10	66	0	554	1	16	780	0

Major/Minor	Minor2		Minor1		Major1			Major2				
Conflicting Flow All	1094	1367	390	980	1367	278	780	0	0	555	0	0
Stage 1	812	812	-	555	555	-	-	-	-	-	-	-
Stage 2	282	555	-	425	812	-	-	-	-	-	-	-
Critical Hdwy	7.7	6.7	7.1	7.7	6.7	7.1	4.3	-	-	4.3	-	-
Critical Hdwy Stg 1	6.7	5.7	-	6.7	5.7	-	-	-	-	-	-	-
Critical Hdwy Stg 2	6.7	5.7	-	6.7	5.7	-	-	-	-	-	-	-
Follow-up Hdwy	3.6	4.1	3.4	3.6	4.1	3.4	2.3	-	-	2.3	-	-
Pot Cap-1 Maneuver	158	136	587	193	136	696	783	-	-	958	-	-
Stage 1	322	372	-	464	492	-	-	-	-	-	-	-
Stage 2	679	492	-	557	372	-	-	-	-	-	-	-
Platoon blocked, %								-	-	-	-	-
Mov Cap-1 Maneuver	132	132	587	183	132	696	783	-	-	958	-	-
Mov Cap-2 Maneuver	132	132	-	183	132	-	-	-	-	-	-	-
Stage 1	322	361	-	464	492	-	-	-	-	-	-	-
Stage 2	602	492	-	533	361	-	-	-	-	-	-	-

Approach	EB		WB		NB		SB	
HCM Control Delay, s	33.4		17.4		0		0.3	
HCM LOS	D		C					

Minor Lane/Major Mvmt	NBL	NBT	NBR	EBLn1	WBLn1	SBL	SBT	SBR
Capacity (veh/h)	783	-	-	132	376	958	-	-
HCM Lane V/C Ratio	-	-	-	0.041	0.229	0.017	-	-
HCM Control Delay (s)	0	-	-	33.4	17.4	8.8	0.1	-
HCM Lane LOS	A	-	-	D	C	A	A	-
HCM 95th %tile Q(veh)	0	-	-	0.1	0.9	0.1	-	-



**Intersection**

Int Delay, s/veh 2.1

Movement	EBL	EBT	EBR	WBL	WBT	WBR	NBL	NBT	NBR	SBL	SBT	SBR
Lane Configurations		↕			↕			↕			↕	
Traffic Vol, veh/h	2	20	7	8	17	6	18	198	4	7	264	18
Future Vol, veh/h	2	20	7	8	17	6	18	198	4	7	264	18
Conflicting Peds, #/hr	0	0	0	0	0	0	0	0	0	0	0	0
Sign Control	Stop	Stop	Stop	Stop	Stop	Stop	Free	Free	Free	Free	Free	Free
RT Channelized	-	-	None	-	-	None	-	-	None	-	-	None
Storage Length	-	-	-	-	-	-	-	-	-	-	-	-
Veh in Median Storage, #	-	0	-	-	0	-	-	0	-	-	0	-
Grade, %	-	0	-	-	0	-	-	0	-	-	0	-
Peak Hour Factor	67	67	67	75	75	75	76	76	76	78	78	78
Heavy Vehicles, %	10	10	10	10	10	10	10	10	10	10	10	10
Mvmt Flow	3	30	10	11	23	8	24	261	5	9	338	23

Major/Minor	Minor2	Minor1	Major1	Major2
Conflicting Flow All	695	682	350	700
Stage 1	368	368	-	312
Stage 2	327	314	-	388
Critical Hdwy	7.2	6.6	6.3	7.2
Critical Hdwy Stg 1	6.2	5.6	-	6.2
Critical Hdwy Stg 2	6.2	5.6	-	6.2
Follow-up Hdwy	3.59	4.09	3.39	3.59
Pot Cap-1 Maneuver	346	362	676	344
Stage 1	636	608	-	682
Stage 2	669	642	-	620
Platoon blocked, %				
Mov Cap-1 Maneuver	317	350	676	309
Mov Cap-2 Maneuver	317	350	-	309
Stage 1	621	603	-	666
Stage 2	623	627	-	575

Approach	EB	WB	NB	SB
HCM Control Delay, s	15.3	15.8	0.7	0.2
HCM LOS	C	C		

Minor Lane/Major Mvmt	NBL	NBT	NBR	EBLn1WBLn1	SBL	SBT	SBR
Capacity (veh/h)	1155	-	-	393	374	1253	-
HCM Lane V/C Ratio	0.021	-	-	0.11	0.111	0.007	-
HCM Control Delay (s)	8.2	0	-	15.3	15.8	7.9	0
HCM Lane LOS	A	A	-	C	C	A	A
HCM 95th %tile Q(veh)	0.1	-	-	0.4	0.4	0	-

Intersection												
Int Delay, s/veh	2.7											
Movement	EBL	EBT	EBR	WBL	WBT	WBR	NBL	NBT	NBR	SBL	SBT	SBR
Lane Configurations		↕			↕		↗	↗	↗	↗	↗	↗
Traffic Vol, veh/h	11	13	25	2	11	0	17	530	0	1	892	13
Future Vol, veh/h	11	13	25	2	11	0	17	530	0	1	892	13
Conflicting Peds, #/hr	0	0	0	0	0	0	0	0	0	0	0	0
Sign Control	Stop	Stop	Stop	Stop	Stop	Stop	Free	Free	Free	Free	Free	Free
RT Channelized	-	-	None	-	-	None	-	-	Free	-	-	Free
Storage Length	-	-	-	-	-	-	515	-	515	520	-	480
Veh in Median Storage, #	-	0	-	-	0	-	-	0	-	-	0	-
Grade, %	-	0	-	-	0	-	-	0	-	-	0	-
Peak Hour Factor	67	67	67	69	69	69	92	92	92	91	91	91
Heavy Vehicles, %	10	10	10	10	10	10	10	10	10	10	10	10
Mvmt Flow	16	19	37	3	16	0	18	576	0	1	980	14

Major/Minor	Minor2		Minor1		Major1		Major2					
Conflicting Flow All	1314	1594	490	1114	1594	288	980	0	-	576	0	0
Stage 1	982	982	-	612	612	-	-	-	-	-	-	-
Stage 2	332	612	-	502	982	-	-	-	-	-	-	-
Critical Hdwy	7.7	6.7	7.1	7.7	6.7	7.1	4.3	-	-	4.3	-	-
Critical Hdwy Stg 1	6.7	5.7	-	6.7	5.7	-	-	-	-	-	-	-
Critical Hdwy Stg 2	6.7	5.7	-	6.7	5.7	-	-	-	-	-	-	-
Follow-up Hdwy	3.6	4.1	3.4	3.6	4.1	3.4	2.3	-	-	2.3	-	-
Pot Cap-1 Maneuver	108	98	503	153	98	685	653	-	0	940	-	0
Stage 1	252	308	-	428	463	-	-	-	0	-	-	0
Stage 2	634	463	-	500	308	-	-	-	0	-	-	0
Platoon blocked, %								-			-	
Mov Cap-1 Maneuver	92	95	503	117	95	685	653	-	-	940	-	-
Mov Cap-2 Maneuver	92	95	-	117	95	-	-	-	-	-	-	-
Stage 1	245	308	-	416	450	-	-	-	-	-	-	-
Stage 2	595	450	-	433	308	-	-	-	-	-	-	-

Approach	EB	WB	NB	SB
HCM Control Delay, s	45.2	50.3	0.3	0
HCM LOS	E	F		

Minor Lane/Major Mvmt	NBL	NBT	EBLn1	WBLn1	SBL	SBT
Capacity (veh/h)	653	-	160	98	940	-
HCM Lane V/C Ratio	0.028	-	0.457	0.192	0.001	-
HCM Control Delay (s)	10.7	-	45.2	50.3	8.8	-
HCM Lane LOS	B	-	E	F	A	-
HCM 95th %tile Q(veh)	0.1	-	2.1	0.7	0	-



HCM 6th Signalized Intersection Summary  
9: SR-86 & Worthington Rd/E Barioni Blvd

Near Term + Project PM  
04/11/2023

Movement	EBL	EBT	EBR	WBL	WBT	WBR	NBL	NBT	NBR	SBL	SBT	SBR
Lane Configurations												
Traffic Volume (veh/h)	55	115	192	127	102	44	106	811	35	47	848	49
Future Volume (veh/h)	55	115	192	127	102	44	106	811	35	47	848	49
Initial Q (Qb), veh	0	0	0	0	0	0	0	0	0	0	0	0
Ped-Bike Adj(A_pbT)	1.00		0.98	1.00		0.98	1.00		0.99	1.00		0.99
Parking Bus, Adj	1.00	1.00	1.00	1.00	1.00	1.00	1.00	1.00	1.00	1.00	1.00	1.00
Work Zone On Approach		No			No			No			No	
Adj Sat Flow, veh/h/ln	1752	1752	1752	1752	1752	1752	1752	1752	1752	1752	1752	1752
Adj Flow Rate, veh/h	74	155	259	157	126	54	120	922	40	55	998	58
Peak Hour Factor	0.74	0.74	0.74	0.81	0.81	0.81	0.88	0.88	0.88	0.85	0.85	0.85
Percent Heavy Veh, %	10	10	10	10	10	10	10	10	10	10	10	10
Cap, veh/h	111	233	291	180	145	278	142	1180	51	70	1022	59
Arrive On Green	0.20	0.20	0.20	0.19	0.19	0.19	0.09	0.36	0.36	0.04	0.32	0.32
Sat Flow, veh/h	557	1167	1458	946	759	1457	1668	3248	141	1668	3195	186
Grp Volume(v), veh/h	229	0	259	283	0	54	120	472	490	55	520	536
Grp Sat Flow(s),veh/h/ln	1724	0	1458	1705	0	1457	1668	1664	1725	1668	1664	1716
Q Serve(g_s), s	10.8	0.0	15.2	14.2	0.0	2.7	6.2	22.2	22.2	2.9	27.1	27.2
Cycle Q Clear(g_c), s	10.8	0.0	15.2	14.2	0.0	2.7	6.2	22.2	22.2	2.9	27.1	27.2
Prop In Lane	0.32		1.00	0.55		1.00	1.00		0.08	1.00		0.11
Lane Grp Cap(c), veh/h	344	0	291	325	0	278	142	604	626	70	532	549
V/C Ratio(X)	0.67	0.00	0.89	0.87	0.00	0.19	0.84	0.78	0.78	0.78	0.98	0.98
Avail Cap(c_a), veh/h	355	0	300	355	0	303	142	604	626	101	532	549
HCM Platoon Ratio	1.00	1.00	1.00	1.00	1.00	1.00	1.00	1.00	1.00	1.00	1.00	1.00
Upstream Filter(I)	1.00	0.00	1.00	1.00	0.00	1.00	1.00	1.00	1.00	1.00	1.00	1.00
Uniform Delay (d), s/veh	32.5	0.0	34.2	34.5	0.0	29.9	39.6	24.9	24.9	41.7	29.6	29.6
Incr Delay (d2), s/veh	4.5	0.0	26.0	19.2	0.0	0.3	34.3	6.6	6.4	22.0	33.0	32.4
Initial Q Delay(d3),s/veh	0.0	0.0	0.0	0.0	0.0	0.0	0.0	0.0	0.0	0.0	0.0	0.0
%ile BackOfQ(50%),veh/ln	4.8	0.0	7.3	7.5	0.0	1.0	3.8	9.0	9.3	1.6	14.7	15.1
Unsig. Movement Delay, s/veh												
LnGrp Delay(d),s/veh	37.0	0.0	60.2	53.7	0.0	30.2	73.9	31.5	31.2	63.7	62.5	62.0
LnGrp LOS	D	A	E	D	A	C	E	C	C	E	E	E
Approach Vol, veh/h		488			337			1082			1111	
Approach Delay, s/veh		49.3			49.9			36.1			62.3	
Approach LOS		D			D			D			E	
Timer - Assigned Phs	1	2		4	5	6		8				
Phs Duration (G+Y+Rc), s	8.2	36.4		22.0	12.0	32.6		21.3				
Change Period (Y+Rc), s	4.5	4.5		4.5	4.5	4.5		4.5				
Max Green Setting (Gmax), s	5.3	30.3		18.1	7.5	28.1		18.3				
Max Q Clear Time (g_c+I1), s	4.9	24.2		17.2	8.2	29.2		16.2				
Green Ext Time (p_c), s	0.0	2.8		0.2	0.0	0.0		0.4				
<b>Intersection Summary</b>												
HCM 6th Ctrl Delay				49.4								
HCM 6th LOS				D								

**Intersection**

Intersection Delay, s/veh 12.6

Intersection LOS B

Movement	EBL	EBT	EBR	WBL	WBT	WBR	NBL	NBT	NBR	SBL	SBT	SBR
Lane Configurations		↕			↕			↕			↕	
Traffic Vol, veh/h	12	107	52	11	112	30	52	212	9	12	227	27
Future Vol, veh/h	12	107	52	11	112	30	52	212	9	12	227	27
Peak Hour Factor	0.91	0.91	0.91	0.78	0.78	0.78	0.95	0.95	0.95	0.97	0.97	0.97
Heavy Vehicles, %	10	10	10	10	10	10	10	10	10	10	10	10
Mvmt Flow	13	118	57	14	144	38	55	223	9	12	234	28
Number of Lanes	0	1	0	0	1	0	0	1	0	0	1	0

Approach	EB	WB	NB	SB
Opposing Approach	WB	EB	SB	NB
Opposing Lanes	1	1	1	1
Conflicting Approach Left	SB	NB	EB	WB
Conflicting Lanes Left	1	1	1	1
Conflicting Approach Right	NB	SB	WB	EB
Conflicting Lanes Right	1	1	1	1
HCM Control Delay	11.6	11.8	13.5	13
HCM LOS	B	B	B	B

Lane	NBLn1	EBLn1	WBLn1	SBLn1
Vol Left, %	19%	7%	7%	5%
Vol Thru, %	78%	63%	73%	85%
Vol Right, %	3%	30%	20%	10%
Sign Control	Stop	Stop	Stop	Stop
Traffic Vol by Lane	273	171	153	266
LT Vol	52	12	11	12
Through Vol	212	107	112	227
RT Vol	9	52	30	27
Lane Flow Rate	287	188	196	274
Geometry Grp	1	1	1	1
Degree of Util (X)	0.456	0.307	0.323	0.432
Departure Headway (Hd)	5.715	5.89	5.934	5.671
Convergence, Y/N	Yes	Yes	Yes	Yes
Cap	626	607	602	631
Service Time	3.777	3.961	4.005	3.735
HCM Lane V/C Ratio	0.458	0.31	0.326	0.434
HCM Control Delay	13.5	11.6	11.8	13
HCM Lane LOS	B	B	B	B
HCM 95th-tile Q	2.4	1.3	1.4	2.2



HCM 6th Signalized Intersection Summary  
 11: Hwy 111 & Worthington Rd/E. Worthington Rd

Near Term + Project PM  
 04/11/2023



Movement	EBL	EBT	EBR	WBL	WBT	WBR	NBL	NBT	NBR	SBL	SBT	SBR
Lane Configurations		↔			↔		↗	↗	↗	↗	↗	↗
Traffic Volume (veh/h)	19	55	73	13	51	14	51	519	23	14	842	34
Future Volume (veh/h)	19	55	73	13	51	14	51	519	23	14	842	34
Initial Q (Qb), veh	0	0	0	0	0	0	0	0	0	0	0	0
Ped-Bike Adj(A_pbT)	1.00		1.00	1.00		1.00	1.00		1.00	1.00		1.00
Parking Bus, Adj	1.00	1.00	1.00	1.00	1.00	1.00	1.00	1.00	1.00	1.00	1.00	1.00
Work Zone On Approach		No			No			No			No	
Adj Sat Flow, veh/h/ln	1870	1870	1870	1870	1870	1870	1870	1870	1870	1870	1870	1870
Adj Flow Rate, veh/h	23	65	87	16	65	18	54	546	0	16	979	0
Peak Hour Factor	0.84	0.84	0.84	0.79	0.78	0.78	0.95	0.95	0.95	0.86	0.86	0.86
Percent Heavy Veh, %	2	2	2	2	2	2	2	2	2	2	2	2
Cap, veh/h	113	153	175	118	274	67	232	1590		86	1300	
Arrive On Green	0.21	0.21	0.21	0.21	0.21	0.21	0.13	0.45	0.00	0.05	0.37	0.00
Sat Flow, veh/h	115	726	831	129	1300	318	1781	3554	1585	1781	3554	1585
Grp Volume(v), veh/h	175	0	0	99	0	0	54	546	0	16	979	0
Grp Sat Flow(s),veh/h/ln	1672	0	0	1747	0	0	1781	1777	1585	1781	1777	1585
Q Serve(g_s), s	0.0	0.0	0.0	0.0	0.0	0.0	1.3	4.6	0.0	0.4	11.1	0.0
Cycle Q Clear(g_c), s	4.1	0.0	0.0	2.1	0.0	0.0	1.3	4.6	0.0	0.4	11.1	0.0
Prop In Lane	0.13		0.50	0.16		0.18	1.00		1.00	1.00		1.00
Lane Grp Cap(c), veh/h	441	0	0	459	0	0	232	1590		86	1300	
V/C Ratio(X)	0.40	0.00	0.00	0.22	0.00	0.00	0.23	0.34		0.19	0.75	
Avail Cap(c_a), veh/h	736	0	0	762	0	0	465	1661		465	1661	
HCM Platoon Ratio	1.00	1.00	1.00	1.00	1.00	1.00	1.00	1.00	1.00	1.00	1.00	1.00
Upstream Filter(l)	1.00	0.00	0.00	1.00	0.00	0.00	1.00	1.00	0.00	1.00	1.00	0.00
Uniform Delay (d), s/veh	16.0	0.0	0.0	15.2	0.0	0.0	18.0	8.3	0.0	21.0	12.8	0.0
Incr Delay (d2), s/veh	0.6	0.0	0.0	0.2	0.0	0.0	0.5	0.1	0.0	1.0	1.5	0.0
Initial Q Delay(d3),s/veh	0.0	0.0	0.0	0.0	0.0	0.0	0.0	0.0	0.0	0.0	0.0	0.0
%ile BackOfQ(50%),veh/ln	1.5	0.0	0.0	0.8	0.0	0.0	0.4	1.0	0.0	0.2	3.0	0.0
Unsig. Movement Delay, s/veh												
LnGrp Delay(d),s/veh	16.5	0.0	0.0	15.4	0.0	0.0	18.5	8.4	0.0	22.1	14.3	0.0
LnGrp LOS	B	A	A	B	A	A	B	A		C	B	
Approach Vol, veh/h		175			99			600			995	
Approach Delay, s/veh		16.5			15.4			9.3			14.4	
Approach LOS		B			B			A			B	
Timer - Assigned Phs	1	2		4	5	6		8				
Phs Duration (G+Y+Rc), s	6.7	25.1		14.2	10.5	21.3		14.2				
Change Period (Y+Rc), s	4.5	4.5		4.5	4.5	4.5		4.5				
Max Green Setting (Gmax), s	21.5	21.5		18.0	12.0	21.5		18.0				
Max Q Clear Time (g_c+I), s	6.6	6.6		6.1	3.3	13.1		4.1				
Green Ext Time (p_c), s	0.0	2.7		0.7	0.0	3.7		0.4				

Intersection Summary

HCM 6th Ctrl Delay	13.0
HCM 6th LOS	B

Notes

Unsignalized Delay for [NBR, SBR] is excluded from calculations of the approach delay and intersection delay.

## APPENDIX E

### EXCERPT FROM THE *IMPERIAL COUNTY TRANSPORTATION COMMISSION REGIONAL ACTIVE TRANSPORTATION PLAN*

Imperial County Transportation Commission

# Regional Active Transportation Plan

February 2022 Final



EEC ORIGINAL PKG



## 2.1.2 COUNTY MODE SHARE

According to the 2019 ACS, there are an estimated 59,343 workers in Imperial County. Travel mode splits for workers' commute trips are as follows:

Approximately 89.8% of workers in Imperial County drive to work. The data suggests that investments in transit and other forms of transportation can help reduce commuter dependency on vehicular trips. This would result in reduced vehicle miles traveled, reduction of GHG emissions, and potential reduction of traffic congestion in Imperial County.

### WALKING MODE SHARE

Walking mode share measures the percentage of workers aged 16 years and over who commute to work by foot. Mode share reflects how well infrastructure and land-use patterns support travel to work by foot. In a city or community, walking mode share patterns are connected to the relative proximity of housing to employment centers.

### BICYCLING MODE SHARE

Similar to the walking mode share, bicycling mode share measures the percentage of resident workers aged 16 years and over who commute to work by bicycle.

### PUBLIC TRANSIT MODE SHARE

Transit mode share measures the percentage of workers aged 16 years and over who commute to work by transit. This mode share reflects how well first mile-last mile infrastructure, transit routes, and land-use patterns support travel to work by transit.

### TRAVEL TIME TO WORK (Drive and Walk)

Figure 2-1 compares the travel modeshare between the County, State, and United States based on the 2019 ACS. The data suggests that the County has a 4.5% to 6% higher dependence on personal vehicles for travel, than the state and U.S. The data also suggests that the county is on par with the state and the U.S. for walking and carpool travel modes.



Bicycle lane and continental high-visibility crosswalk in Seeley

EEC ORIGINAL PKG



**FIGURE 2-1:** Correlation of Travel Modeshare

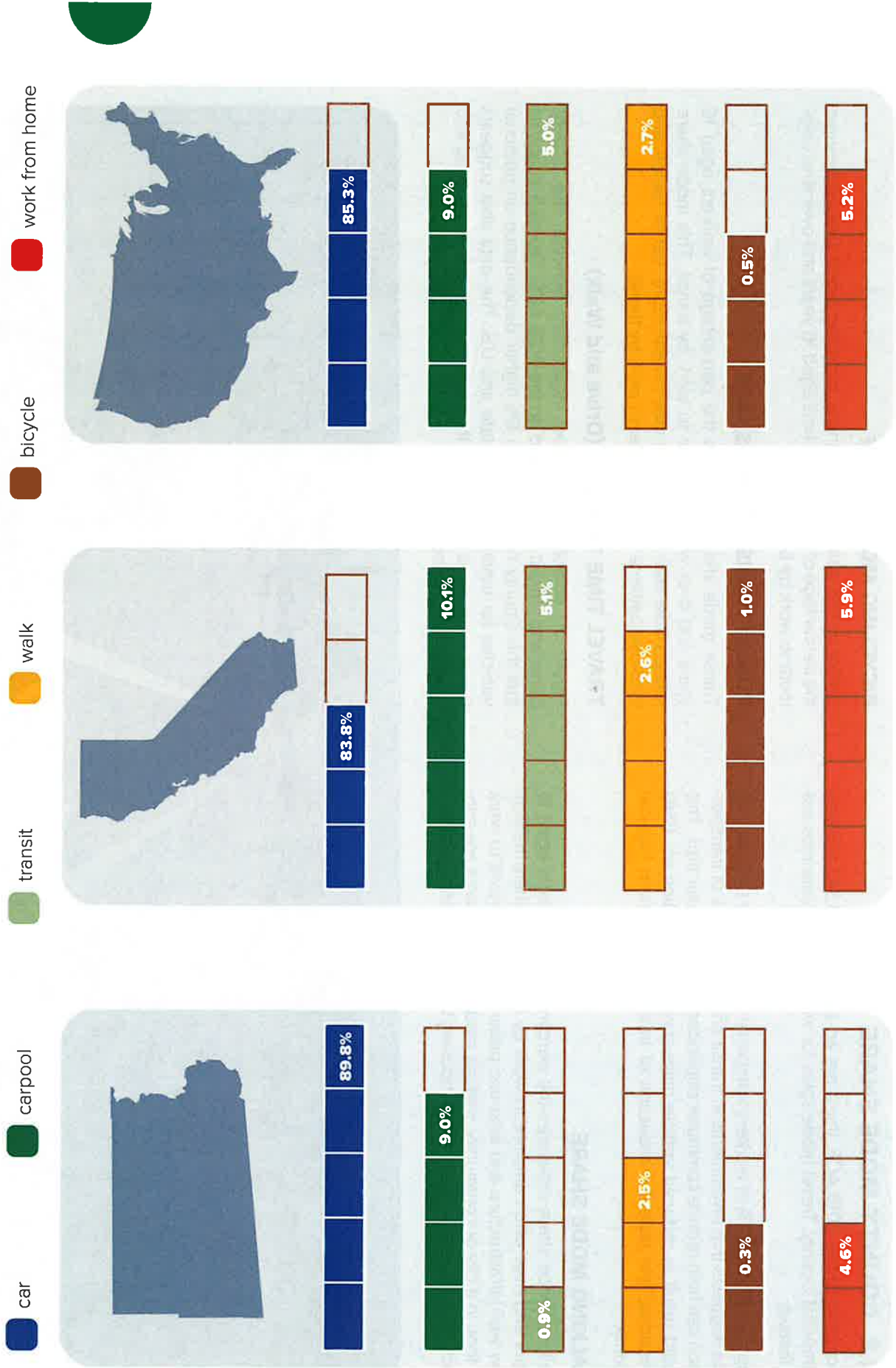

**END OF APPENDICES**

# MAJOR SUBDIVISION

I.C. PLANNING & DEVELOPMENT SERVICES DEPT  
801 Main Street, El Centro, CA 92243 (760) 482-4236

- APPLICANT MUST COMPLETE ALL NUMBERED (black) SPACES - Please type or print -

1. PROPERTY OWNER'S NAME See Attachment due to having 3 Property Owners	EMAIL ADDRESS See Attachment due to having 3 Property Owners
2. MAILING ADDRESS See Attachment due to having 3 Property Owners	ZIP CODE PHONE NUMBER See Attachment due to having 3 Property Owners
3. ENGINEER'S NAME The Holt Group (Jack Holt)	CA. LICENSE NO. Civil PE# 31773 EMAIL ADDRESS jgalvan@theholtgroup.net
4. MAILING ADDRESS 1601 N. Imperial Avenue	ZIP CODE 92243 PHONE NUMBER 760-337-3883
5. PROPERTY (site) ADDRESS See Attachment due to having 3 Property Owners	LOCATION See Attachment due to having 3 Property Owners
6. ASSESSOR'S PARCEL NO. See Attachment due to having 3 Property Owners	SIZE OF PROPERTY (in acres or square foot) See Attachment due to having 3 Property Owners
7. LEGAL DESCRIPTION (attach separate sheet if necessary) See Attachment due to having 3 Property Owners	
8. EXPLAIN PURPOSE/REASON FOR SUBDIVISION Rail accessible subdivision for the benefit of local agri-business products and others.	

9. Proposed DIVISION of the above specified land is as follows:

PARCEL	SIZE in acres or sq. feet	EXISTING USE	PROPOSED USE	ZONE
1 or A	See Attached.			
2 or B				
3 or C				
4 or D				

**PLEASE PROVIDE CLEAR & CONCISE INFORMATION (ATTACH SEPARATE SHEET IF NEEDED)**

10. DESCRIBE PROPOSED SEWER SYSTEM(s)	Septic with leach
11. DESCRIBE PROPOSED WATER SYSTEM	Service pipe connection to Dahlia Lateral 8
12. DESCRIBE PROPOSED ACCESS TO MERGED PARCEL	A mix of access from SR-86, and Harris Road via an industrial collector - please see Tentative Tract Map
13. IS THIS PARCEL PLANNED TO BE ANNEXED? <input type="checkbox"/> Yes <input checked="" type="checkbox"/> No	IF YES, TO WHAT CITY or DISTRICT? N/A

I HEREBY APPLY FOR PERMISSION TO DIVIDE THE ABOVE SPECIFIED PROPERTY THAT I  OWN  CONTROL, AS PER ATTACHED INFORMATION, AND PER THE MAP ACT AND PER THE SUBDIVISION ORDINANCE.

I, CERTIFY THAT THE ABOVE INFORMATION, TO THE BEST OF MY KNOWLEDGE, IS TRUE AND CORRECT.

John Moiola for Tomcat Development LLC 11-16-2021  
 Print Name (owner) \_\_\_\_\_ Date \_\_\_\_\_  
 Signature (owner) \_\_\_\_\_  
 Print Name (Agent) \_\_\_\_\_ Date \_\_\_\_\_  
 Signature (Agent) \_\_\_\_\_

**REQUIRED SUPPORT DOCUMENTS**

- A. TENTATIVE MAP
- B. PRELIMINARY TITLE REPORT (6 months or newer)
- C. FEE \_\_\_\_\_
- D. OTHER \_\_\_\_\_

**Special Note:**  
An notarized owners affidavit is required if application is signed by Agent.

APPLICATION RECEIVED BY: _____	DATE _____	REVIEW / APPROVAL BY OTHER DEPT'S required.
APPLICATION DEEMED COMPLETE BY: _____	DATE _____	<input type="checkbox"/> P. W.
APPLICATION REJECTED BY: _____	DATE _____	<input type="checkbox"/> E. H. S.
TENTATIVE HEARING BY: _____	DATE _____	<input type="checkbox"/> A. P. C. D.
FINAL ACTION: <input type="checkbox"/> APPROVED <input type="checkbox"/> DENIED	DATE _____	<input type="checkbox"/> O. E. S.
		<input type="checkbox"/> _____
		<input type="checkbox"/> _____

**TR#**  
\_\_\_\_\_

**EEC ORIGINAL PKG**

## Tentative Tract Map Application Attachment

### Property Owners (Sections 1, 2, 5, 6 & 7 County App):

#### 1 – Tomcat Development LLC

APNs 040-340-032 & -033

Mailing Address: 1594 Gonder Road, Brawley, CA

Email Address: john@moiolabros.com

Zip Code: 92227

Phone Number: 760-455-0399

#### Legal Description:

##### PARCEL I:

TRACT 86, TOWNSHIP 14 SOUTH, RANGE 14 EAST, S.B.M., IN AN UNINCORPORATED AREA OF THE COUNTY OF IMPERIAL, STATE OF CALIFORNIA, ACCORDING TO THE OFFICIAL PLAT THEREOF.

EXCEPTING THEREFROM THE SOUTH 660 FEET OF THE WEST 330 FEET THEREOF.

ALSO EXCEPTING THEREFROM THAT PORTION LYING WITHIN STATE HWY 86.

ALSO EXCEPTING THEREFROM THE FOLLOWING DESCRIBED PARCEL:

BEGINNING AT THE INTERSECTION OF THE EAST LINE OF HIGHWAY 99 WITH THE NORTH LINE OF TRACT 86; THENCE SOUTH 75 FEET; THENCE NORTHEASTERLY TO A POINT IN THE NORTH



LINE OF TRACT 86 WHICH IS 75 FEET EAST OF THE POINT OF BEGINNING; THENCE WEST 75 FEET TO SAID POINT OF BEGINNING, AS CONVEYED TO MONIQUE BAER, A SINGLE WOMAN IN INSTRUMENT RECORDED SEPTEMBER 22, 1964 AS INSTRUMENT NO. 96 OF OFFICIAL RECORDS.

**PARCEL II:**

THE SOUTH 660 FEET OF THE WEST 330 FEET OF TRACT 86, TOWNSHIP 14 SOUTH, RANGE 14 EAST, S.B.M., IN AN UNINCORPORATED AREA OF THE COUNTY OF IMPERIAL, STATE OF CALIFORNIA, ACCORDING TO THE OFFICIAL PLAT THEREOF.

EXCEPTING THEREFROM THAT PORTION LYING WITHIN HWY 86.

**PARCEL III:**

THE WEST 40 ACRES OF THE NORTH 80 ACRES OF TRACT 83, TOWNSHIP 14 SOUTH, RANGE 14 EAST, S.B.M., IN AN UNINCORPORATED AREA OF THE COUNTY OF IMPERIAL, STATE OF CALIFORNIA, ACCORDING TO THE OFFICIAL PLAT THEREOF.

**PARCEL IV:**

THAT PORTION OF TRACT 285, TOWNSHIP 14 SOUTH, RANGE 14 EAST, S.B.M., IN AN UNINCORPORATED AREA OF THE COUNTY OF IMPERIAL, STATE OF CALIFORNIA, ACCORDING TO THE OFFICIAL PLAT THEREOF, DESCRIBED AS FOLLOWS:

BEGINNING AT THE SOUTHEAST CORNER OF SAID TRACT 285; THENCE NORTH ALONG THE EAST LINE THEREOF, A DISTANCE OF 50 FEET; THENCE SOUTHWEST TO A POINT IN THE SOUTH LINE OF SAID TRACT 285 WHICH IS 50 FEET WEST FROM THE SOUTHEAST CORNER THEREOF; THENCE EAST ALONG THE SOUTH LINE THEREOF, 50 FEET TO THE POINT OF BEGINNING.

**2 – Van Groningen Living Trust – Trustees: Roger & Larinda Van Groningen  
APN 040-340-006**

Mailing Address: 8000 East Manning, Fowler, CA

Email Address: roger@vanglogistics.com

Zip Code: 93625-9727

Phone Number: 559-834-4389

**Legal Description:**

Those portions of the South half (S 1/2) and the East half (E 1/2) of the North half (N 1/2) of Tract 83, Township 14 South, Range 14 East, S.B.M., in an unincorporated area of the County of Imperial, State of California, according to the Official Plat thereof, lying West of the railroad right of way.

**3 – Ronald Martin (1/2); &  
Beverly A. Martin Revocable Trust UDT dated December 28, 2010 (1/2)  
APN 040-340-004**

Mailing Address: 4431 Monaco Street, San Diego, CA

Email Address: steve@sgmartincpa.com

Zip Code: 92107

Phone Number: 619-857-2391

**Legal Description:**

Tracts 84 and 87, Township 14 South, Range 14 East, S.B.M., in an unincorporated area of the County of Imperial, State of California, according to the Official Plat thereof.

Excepting therefrom that portion thereof granted to the State of California by deed recorded June 20, 1945 in book 643, page 106 of Official Records.

**Proposed Division of the Subject Property (Section 9 of County App):**

**Parcel 1:**

Size – 38.697 acres

Existing Use – industrial land currently being farmed

Proposed Use – Commodity Transloading & Storage

Zone – Proposed ML – I-3

**Parcel 2:**

Size – 9.342 acres

Existing Use – Vacant industrial land

Proposed Use – Commodity Transloading & Storage

Zone – Proposed ML – I-3

**Parcel 3:**

Size – 9.865 acres

Existing Use – Cemetery & vacant industrial land

Proposed Use – Cemetery and veteran memorial park

Zone – Proposed ML – I-3

**Parcel 4:**

Size – 18.952 acres

Existing Use – Vacant industrial land

Proposed Use – Commodity Transloading & Storage

Zone – Proposed ML – I-3

**Parcel 5:**

Size – 17.310 acres

Existing Use – Industrial land – portion farmed & portion vacant

Proposed Use – Commodity Transloading & Storage

Zone – Proposed ML – I-3

**Parcel 6:**

Size – 10.00 acres

Existing Use – Industrial land currently being farmed

Proposed Use – Commodity Transloading & Storage

Zone – Proposed ML – I-3

**Parcel 7:**

Size – 10.029 acres

Existing Use – Industrial land – portion farmed & portion vacant

Proposed Use – Commodity Transloading & Storage

Zone – Proposed ML – I-3

**Parcel 8:**

Size – 20.294 acres

Existing Use – Vacant industrial land

Proposed Use – Storm Water Retention Basin

Zone – Proposed ML – I-3

**Parcel 9:**

Size – 143.554 acres

Existing Use – Vacant industrial land

Proposed Use – Commodity Transloading & Storage

Zone – Proposed ML – I-3









---

## PRELIMINARY REPORT

Order No.: 7102019328-SB

Property: APN/Parcel ID: 040-340-032-000

*In response to the application for a policy of title insurance referenced herein, **Chicago Title Company** hereby reports that it is prepared to issue, or cause to be issued, as of the date hereof, a policy or policies of title insurance describing the land and the estate or interest therein hereinafter set forth, insuring against loss which may be sustained by reason of any defect, lien or encumbrance not shown or referred to as an exception herein or not excluded from coverage pursuant to the printed Schedules, Conditions and Stipulations or Conditions of said policy forms.*

*The printed Exceptions and Exclusions from the coverage and Limitations on Covered Risks of said policy or policies are set forth in Attachment One. The policy to be issued may contain an arbitration clause. When the Amount of Insurance is less than that set forth in the arbitration clause, all arbitrable matters shall be arbitrated at the option of either the Company or the Insured as the exclusive remedy of the parties. Limitations on Covered Risks applicable to the CLTA and ALTA Homeowner's Policies of Title Insurance which establish a Deductible Amount and a Maximum Dollar Limit of Liability for certain coverages are also set forth in Attachment One. Copies of the policy forms should be read. They are available from the office which issued this report.*

*This report (and any supplements or amendments hereto) is issued solely for the purpose of facilitating the issuance of a policy of title insurance and no liability is assumed hereby. If it is desired that liability be assumed prior to the issuance of a policy of title insurance, a Binder or Commitment should be requested.*

*The policy(ies) of title insurance to be issued hereunder will be policy(ies) of Chicago Title Insurance Company, a Florida corporation.*

***Please read the exceptions shown or referred to herein and the exceptions and exclusions set forth in Attachment One of this report carefully. The exceptions and exclusions are meant to provide you with notice of matters which are not covered under the terms of the title insurance policy and should be carefully considered.***

***It is important to note that this preliminary report is not a written representation as to the condition of title and may not list all liens, defects and encumbrances affecting title to the land.***

**Chicago Title Insurance Company**

By:



\_\_\_\_\_  
Randy Quirk, President

Attest:



\_\_\_\_\_  
Marjorie Nemzura, Secretary

Countersigned By:



\_\_\_\_\_  
Authorized Officer or Agent

Date:



Visit Us on our Website: [www.ctic.com](http://www.ctic.com)



**ISSUING OFFICE:** 1425 Main Street, El Centro, CA 92244

**FOR SETTLEMENT INQUIRIES, CONTACT:**

TBD

•

• FAX

## PRELIMINARY REPORT

**Update: 3**

**Title Officer:** Stacey Benner  
**Email:** [stacey.benner@ctt.com](mailto:stacey.benner@ctt.com)  
**Phone No.:** (760)335-3125  
**Fax No.:** (760)353-1307  
**Title No.:** 7102019328-SB

**Customer:**  
**Email:**  
**Phone No.:**  
**Fax No.:**  
**Ref. No.:**

**PROPERTY ADDRESS(ES):** APN/Parcel ID(s) 040-340-032-000 and 040-340-033-000

**EFFECTIVE DATE: November 2, 2021 at 12:00 AM**

The form of policy or policies of title insurance contemplated by this report is:

CLTA Standard Coverage Policy 1990 (04-08-14)

1. The estate or interest in the Land hereinafter described or referred to covered by this Report is:

Fee

2. Title to said estate or interest at the date hereof is vested in:

Tomcat Development LLC, a California limited liability company

3. The Land referred to in this Report is described as follows:

**For APN/Parcel ID(s): 040-340-032-000 and 040-340-033-000**

PARCEL I:

TRACT 86, TOWNSHIP 14 SOUTH, RANGE 14 EAST, S.B.M., IN AN UNINCORPORATED AREA OF THE COUNTY OF IMPERIAL, STATE OF CALIFORNIA, ACCORDING TO THE OFFICIAL PLAT THEREOF.

EXCEPTING THEREFROM THE SOUTH 660 FEET OF THE WEST 330 FEET THEREOF.

ALSO EXCEPTING THEREFROM THAT PORTION LYING WITHIN STATE HWY 86.

ALSO EXCEPTING THEREFROM THE FOLLOWING DESCRIBED PARCEL:

BEGINNING AT THE INTERSECTION OF THE EAST LINE OF HIGHWAY 99 WITH THE NORTH LINE OF TRACT 86; THENCE SOUTH 75 FEET; THENCE NORTHEASTERLY TO A POINT IN THE NORTH



**PRELIMINARY REPORT**  
(continued)

LINE OF TRACT 86 WHICH IS 75 FEET EAST OF THE POINT OF BEGINNING; THENCE WEST 75 FEET TO SAID POINT OF BEGINNING, AS CONVEYED TO MONIQUE BAER, A SINGLE WOMAN IN INSTRUMENT RECORDED SEPTEMBER 22, 1964 AS INSTRUMENT NO. 96 OF OFFICIAL RECORDS.

**PARCEL II:**

THE SOUTH 660 FEET OF THE WEST 330 FEET OF TRACT 86, TOWNSHIP 14 SOUTH, RANGE 14 EAST, S.B.M., IN AN UNINCORPORATED AREA OF THE COUNTY OF IMPERIAL, STATE OF CALIFORNIA, ACCORDING TO THE OFFICIAL PLAT THEREOF.

EXCEPTING THEREFROM THAT PORTION LYING WITHIN HWY 86.

**PARCEL III:**

THE WEST 40 ACRES OF THE NORTH 80 ACRES OF TRACT 83, TOWNSHIP 14 SOUTH, RANGE 14 EAST, S.B.M., IN AN UNINCORPORATED AREA OF THE COUNTY OF IMPERIAL, STATE OF CALIFORNIA, ACCORDING TO THE OFFICIAL PLAT THEREOF.

**PARCEL IV:**

THAT PORTION OF TRACT 285, TOWNSHIP 14 SOUTH, RANGE 14 EAST, S.B.M., IN AN UNINCORPORATED AREA OF THE COUNTY OF IMPERIAL, STATE OF CALIFORNIA, ACCORDING TO THE OFFICIAL PLAT THEREOF, DESCRIBED AS FOLLOWS:

BEGINNING AT THE SOUTHEAST CORNER OF SAID TRACT 285; THENCE NORTH ALONG THE EAST LINE THEREOF, A DISTANCE OF 50 FEET; THENCE SOUTHWEST TO A POINT IN THE SOUTH LINE OF SAID TRACT 285 WHICH IS 50 FEET WEST FROM THE SOUTHEAST CORNER THEREOF; THENCE EAST ALONG THE SOUTH LINE THEREOF, 50 FEET TO THE POINT OF BEGINNING.

**AT THE DATE HEREOF, EXCEPTIONS TO COVERAGE IN ADDITION TO THE PRINTED EXCEPTIONS AND EXCLUSIONS IN SAID POLICY FORM WOULD BE AS FOLLOWS:**

1. Property taxes, including any personal property taxes and any assessments collected with taxes are as follows:

Code Area: 069-000  
Tax Identification No.: 040-340-032-000  
Fiscal Year: 2021-2022  
1st Installment: \$1,357.43 Not Paid  
2nd Installment: \$1,357.43 Not Paid  
Land: \$232,000.00

2. Property taxes, including any personal property taxes and any assessments collected with taxes are as follows:

Code Area: 069-000  
Tax Identification No.: 040-340-033-000  
Fiscal Year: 2021-2022  
1st Installment: \$638.19 Not Paid  
2nd Installment: \$638.19 Not Paid  
Exemption: \$86,000.00  
Land: \$10,000.00

3. Supplemental assessment for 2020-2021:

1st Installment \$14.03, Not Paid  
Must be Paid By: December 10, 2021  
2nd Installment: \$14.03, Not Paid  
Must be Paid By: April 11, 2022  
Bill No.: 990-120-944-001  
Affects: 040-340-033-000

4. The lien of supplemental or escaped assessments of property taxes, if any, made pursuant to the provisions of Chapter 3.5 (commencing with Section 75) or Part 2, Chapter 3, Articles 3 and 4, respectively, of the Revenue and Taxation Code of the State of California as a result of the transfer of title to the vestee named in Schedule A or as a result of changes in ownership or new construction occurring prior to Date of Policy.

5. Taxes and assessments levied by the Imperial Irrigation District, if any.

6. Any water rights or claims or title to water in or under the Land, whether or not shown by the public records.

7. Rights or claims of easements for canals, drains, laterals, irrigation pipelines and gates not recorded in the public record.

8. Title to, and easements in, any portion of the land lying within any highways, roads, streets, or other ways.

9. Easement(s) for the purpose(s) shown below and rights incidental thereto, as granted in a document:

Granted to: State of California  
Purpose: Highway  
Recording No.: in book 101, page 17, Official Records  
Affects: A strip of land 80 feet wide along the West side of said Tract 86.

**EXCEPTIONS**  
(continued)

10. Easement(s) for the purpose(s) shown below and rights incidental thereto, as granted in a document:
- Granted to: Imperial Irrigation District  
Purpose: Canal, telephone and power lines.  
Recording No.: in book 697, page 346, Official Records  
Affects: The North 150 feet of Tract 86.
11. Easement(s) for the purpose(s) shown below and rights incidental thereto as reserved in a document;
- Purpose: For irrigation, waste or drainage canals, or power or telephone lines.  
Recording No.: in book 806, page 273, Official Records  
Affects: The exact location and extent of said easement is not disclosed of record.
12. The fact that the ownership of said land does not include rights of access to or from the street or highway abutting said land, such rights having been severed from said land by document recorded February 21, 1955 in book 903, page 632, Official Records.
13. Easement(s) for the purpose(s) shown below and rights incidental thereto, as granted in a document:
- Granted to: Imperial Water Company No. 1  
Purpose: Irrigation ditches and canals.  
Recording No.: in book 86, page 309 of Deeds  
Affects: Reference is made to said document for full particulars.
14. Easement(s) for the purpose(s) shown below and rights incidental thereto as reserved in a document;
- Purpose: For irrigation, waste or drainage canals, or power or telephone lines.  
Recording No.: in book 713, page 100, Official Records  
Affects: The exact location and extent of said easement is not disclosed of record.
15. Easement(s) for the purpose(s) shown below and rights incidental thereto, as granted in a document:
- Granted to: Imperial Irrigation District  
Purpose: Canal, telephone and power lines.  
Recording No.: in book 697, page 340, Official Records  
Affects: The West 150 of Tract 285.
16. The effect of that certain document dated September 21, 1951 and recorded in book 821, page 457 of Official Records, wherein Memory Gardens of Imperial Valley, Inc. purports to dedicate the herein described land to private cemetery purposes.
- Reference is made to said document for full particulars.
17. The provisions, stipulations, covenants and conditions contained in that certain agreement by and between Memory Gardens of Imperial Valley and Russell B. Moy, Carlie W. Smith and Fielding Kimball dated June 11, 1954, a copy of which is attached to and a part of deed recorded June 17, 1954 as Document No. 76 in book 887, page 580 of Official Records.
- Reference is made to said document for full particulars.

**EXCEPTIONS**  
(continued)

18. Easement(s) for the purpose(s) shown below and rights incidental thereto, as granted in a document:

Granted to: Imperial Irrigation District  
Purpose: Canal, telephone and/or electric power line.  
Recording Date: August 1, 1957  
Recording No.: in book 973, page 42, Official Records  
Affects: Reference is made to said document for full particulars.

19. Easement(s) for the purpose(s) shown below and rights incidental thereto, as granted in a document:

Granted to: Imperial Irrigation District  
Purpose: A power line.  
Recording Date: October 10, 1962  
Recording No.: in book 1124, page 366, Official Records  
Affects: The center line of said right of way to be along a line which is parallel with and one foot North of the South line of Tract 86.

20. Covenants, conditions and restrictions but omitting any covenants or restrictions, if any, including but not limited to those based upon race, color, religion, sex, sexual orientation, familial status, marital status, disability, handicap, national origin, ancestry, source of income, gender, gender identity, gender expression, medical condition or genetic information, as set forth in applicable state or federal laws, except to the extent that said covenant or restriction is permitted by applicable law, as set forth in the document

Recording Date: September 22, 1964  
Recording No.: 97 in book 1191, page 1121, Official Records

Reference is made to said document for full particulars.

21. Easement(s) for the purpose(s) shown below and rights incidental thereto, as granted in a document:

Granted to: Imperial Irrigation District  
Purpose: For constructing, operating and maintaining a power line or lines.  
Recording Date: September 15, 1989  
Recording No.: 89-15098 in book 1632, page 461, Official Records  
Affects: Along a line which is parallel with and 500 feet East of the East right of way line of said State Highway 86, commencing at the South line of the above described property thereof and extending Northerly 420 feet.

22. Easements, rights or interests arising out of

- (a) the sale or transfer of lots, blocks, plots or sections in Memory Gardens Cemetery or of burial rights therein;
- (b) the sale or transfer of crypts or vaults in any mausoleum, and of niches in any columbarium to be erected on the herein described land, or
- (c) any interment in said land.

23. Easements over any of the unnamed streets, roads, alleys, walks, paths, parks or parkways, shown on the map of said Memory Gardens Cemetery.



**EXCEPTIONS**  
(continued)

24. Restrictions imposed by law regarding the use and disposition of said land or space within any mausoleum or columbarium erected thereon, resulting from the use or dedication of said land for cemetery purposes.
25. The herein described Land is located in an area frequently subject to Land Conservation Contracts executed pursuant to the Williamson Act (Cal. Govt. Code §§ 51200 et seq.). Land Conservation Contracts restrict the land use to agricultural, recreational, open-space and other compatible uses. If the herein described Land is subject to a Land Conservation Contract, please notify the Title Department.

The Company reserves the right to add additional items and/or make further requirements

26. Any right, interest or claim that may exist, arise or be asserted under or pursuant to the Perishable Agricultural Commodities Act of 1930, as amended, 7 USC 499a et seq., the Packers and Stockyard Act of 1921, as amended, 7 USC 181 et seq., or any similar state laws.
27. Please be advised that our search did not disclose any open Deeds of Trust of record. If you should have knowledge of any outstanding obligation, please contact the Title Department immediately for further review prior to closing.

**END OF EXCEPTIONS**

## NOTES

- Note 1.** Notice: Please be aware that due to the conflict between federal and state laws concerning the cultivation, distribution, manufacture or sale of marijuana, the Company is not able to close or insure any transaction involving Land that is associated with these activities.
- Note 2.** If a county recorder, title insurance company, escrow company, real estate broker, real estate agent or association provides a copy of a declaration, governing document or deed to any person, California law requires that the document provided shall include a statement regarding any unlawful restrictions. Said statement is to be in at least 14-point bold face type and may be stamped on the first page of any document provided or included as a cover page attached to the requested document. Should a party to this transaction request a copy of any document reported herein that fits this category, the statement is to be included in the manner described.
- Note 3.** If this company is requested to disburse funds in connection with this transaction, Chapter 598, Statutes of 1989 mandates hold periods for checks deposited to escrow or sub-escrow accounts. The mandatory hold period for cashier's checks, certified checks and teller's checks is one business day after the day deposited. Other checks require a hold period of from two to five business days after the day deposited. In the event that the parties to the contemplated transaction wish to record prior to the time that the funds are available for disbursement (and subject to Company approval), the Company will require the prior written consent of the parties. Upon request, a form acceptable to the company authorizing said early recording may be provided to Escrow for execution.
- Wire Transfers
- There is no mandated hold period for funds deposited by confirmed wire transfer. The Company may disburse such funds the same day.
- Note 4.** Any documents being executed in conjunction with this transaction must be signed in the presence of an authorized Company employee, an authorized employee of an agent, an authorized employee of the insured lender, or by using Bancserv or other approved third-party service. If the above requirements cannot be met, please call the company at the number provided in this report.
- Note 5.** The application for title insurance was placed by reference to only a street address or tax identification number. The proposed Insured must confirm that the legal description in this report covers the parcel(s) of Land requested to be insured. If the legal description is incorrect, the proposed Insured must notify the Company and/or the settlement company in order to prevent errors and to be certain that the legal description for the intended parcel(s) of Land will appear on any documents to be recorded in connection with this transaction and on the policy of title insurance.
- Note 6.** Note: Pursuant to Government Code Section 27388.1, as amended and effective as of 1-1-2018, a Documentary Transfer Tax (DTT) Affidavit may be required to be completed and submitted with each document when DTT is being paid or when an exemption is being claimed from paying the tax. If a governmental agency is a party to the document, the form will not be required. DTT Affidavits may be available at a Tax Assessor-County Clerk-Recorder.
- Note 7.** Due to the special requirements of SB 50 (California Public Resources Code Section 8560 et seq.), any transaction that includes the conveyance of title by an agency of the United States must be approved in advance by the Company's State Counsel, Regional Counsel, or one of their designees.

**NOTES**  
(continued)

**Note 8.** The Company will require the following documents for review prior to the issuance of any title insurance predicated upon a conveyance or encumbrance from the entity named below.

Limited Liability Company: Tomcat Development LLC, a California limited liability company

- a. A copy of its operating agreement, if any, and any and all amendments, supplements and/or modifications thereto, certified by the appropriate manager or member.
- b. If a domestic Limited Liability Company, a copy of its Articles of Organization and all amendment thereto with the appropriate filing stamps.
- c. If the Limited Liability Company is member-managed a full and complete current list of members certified by the appropriate manager or member.
- d. A current dated certificate of good standing from the proper governmental authority of the state in which the entity was created
- e. If less than all members, or managers, as appropriate, will be executing the closing documents, furnish evidence of the authority of those signing.
- f) If Limited Liability Company is a Single Member Entity, a Statement of Information for the Single Member will be required.
- g) Each member and manager of the LLC without an Operating Agreement must execute in the presence of a notary public the Certificate of California LLC (Without an Operating Agreement) Status and Authority form

**END OF NOTES**

**EXHIBIT "A"**  
Legal Description

**For APN/Parcel ID(s): 040-340-032-000 and 040-340-033-000**

---

PARCEL I:

TRACT 86, TOWNSHIP 14 SOUTH, RANGE 14 EAST, S.B.M., IN AN UNINCORPORATED AREA OF THE COUNTY OF IMPERIAL, STATE OF CALIFORNIA, ACCORDING TO THE OFFICIAL PLAT THEREOF.

EXCEPTING THEREFROM THE SOUTH 660 FEET OF THE WEST 330 FEET THEREOF.

ALSO EXCEPTING THEREFROM THAT PORTION LYING WITHIN STATE HWY 86.

ALSO EXCEPTING THEREFROM THE FOLLOWING DESCRIBED PARCEL:

BEGINNING AT THE INTERSECTION OF THE EAST LINE OF HIGHWAY 99 WITH THE NORTH LINE OF TRACT 86; THENCE SOUTH 75 FEET; THENCE NORTHEASTERLY TO A POINT IN THE NORTH LINE OF TRACT 86 WHICH IS 75 FEET EAST OF THE POINT OF BEGINNING; THENCE WEST 75 FEET TO SAID POINT OF BEGINNING, AS CONVEYED TO MONIQUE BAER, A SINGLE WOMAN IN INSTRUMENT RECORDED SEPTEMBER 22, 1964 AS INSTRUMENT NO. 96 OF OFFICIAL RECORDS.

PARCEL II:

THE SOUTH 660 FEET OF THE WEST 330 FEET OF TRACT 86, TOWNSHIP 14 SOUTH, RANGE 14 EAST, S.B.M., IN AN UNINCORPORATED AREA OF THE COUNTY OF IMPERIAL, STATE OF CALIFORNIA, ACCORDING TO THE OFFICIAL PLAT THEREOF.

EXCEPTING THEREFROM THAT PORTION LYING WITHIN HWY 86.

PARCEL III:

THE WEST 40 ACRES OF THE NORTH 80 ACRES OF TRACT 83, TOWNSHIP 14 SOUTH, RANGE 14 EAST, S.B.M., IN AN UNINCORPORATED AREA OF THE COUNTY OF IMPERIAL, STATE OF CALIFORNIA, ACCORDING TO THE OFFICIAL PLAT THEREOF.

PARCEL IV:

THAT PORTION OF TRACT 285, TOWNSHIP 14 SOUTH, RANGE 14 EAST, S.B.M., IN AN UNINCORPORATED AREA OF THE COUNTY OF IMPERIAL, STATE OF CALIFORNIA, ACCORDING TO THE OFFICIAL PLAT THEREOF, DESCRIBED AS FOLLOWS:

BEGINNING AT THE SOUTHEAST CORNER OF SAID TRACT 285; THENCE NORTH ALONG THE EAST LINE THEREOF, A DISTANCE OF 50 FEET; THENCE SOUTHWEST TO A POINT IN THE SOUTH LINE OF SAID TRACT 285 WHICH IS 50 FEET WEST FROM THE SOUTHEAST CORNER THEREOF; THENCE EAST ALONG THE SOUTH LINE THEREOF, 50 FEET TO THE POINT OF BEGINNING.





Inquire before you wire!

## WIRE FRAUD ALERT

This Notice is not intended to provide legal or professional advice.  
If you have any questions, please consult with a lawyer.

All parties to a real estate transaction are targets for wire fraud and many have lost hundreds of thousands of dollars because they simply relied on the wire instructions received via email, without further verification. **If funds are to be wired in conjunction with this real estate transaction, we strongly recommend verbal verification of wire instructions through a known, trusted phone number prior to sending funds.**

In addition, the following non-exclusive self-protection strategies are recommended to minimize exposure to possible wire fraud.

- **NEVER RELY** on emails purporting to change wire instructions. Parties to a transaction rarely change wire instructions in the course of a transaction.
- **ALWAYS VERIFY** wire instructions, specifically the ABA routing number and account number, by calling the party who sent the instructions to you. **DO NOT** use the phone number provided in the email containing the instructions, use phone numbers you have called before or can otherwise verify. **Obtain the number of relevant parties to the transaction as soon as an escrow account is opened.** **DO NOT** send an email to verify as the email address may be incorrect or the email may be intercepted by the fraudster.
- **USE COMPLEX EMAIL PASSWORDS** that employ a combination of mixed case, numbers, and symbols. Make your passwords greater than eight (8) characters. Also, change your password often and do **NOT** reuse the same password for other online accounts.
- **USE MULTI-FACTOR AUTHENTICATION** for email accounts. Your email provider or IT staff may have specific instructions on how to implement this feature.

For more information on wire-fraud scams or to report an incident, please refer to the following links:

**Federal Bureau of Investigation:**  
<http://www.fbi.gov>

**Internet Crime Complaint Center:**  
<http://www.ic3.gov>

## **FIDELITY NATIONAL FINANCIAL CALIFORNIA PRIVACY NOTICE**

Fidelity National Financial, Inc. and its majority-owned subsidiary companies (collectively, "FNF," "our," or "we") respect and are committed to protecting your privacy. This California Privacy Notice explains how we collect, use, and disclose Personal Information, when and to whom we disclose such information, and the rights you, as a California resident ("Consumer"), have regarding your Personal Information ("California Privacy Rights"). Some subsidiaries maintain separate California Privacy Notices or privacy statements. If a subsidiary has a separate California Privacy Notice, it will be available on the subsidiary's website, and this California Privacy Notice does not apply.

### **Collection of categories of Personal Information:**

In the preceding twelve (12) months FNF has collected, and will continue to collect, the following categories of Personal Information from you:

- Identifiers such as name, address, telephone number, IP address, email address, account name, social security number, driver's license number, state identification card, financial information, date of birth, or other similar identifiers;
- Characteristics of protected classifications under California or Federal law;
- Commercial information, including records of personal property, products or services purchased, or other purchasing or consuming histories;
- Internet or other electronic network activity information including, but not limited to browsing history, search history, and information regarding a Consumer's interaction with an Internet website;
- Geolocation data;
- Professional or employment information;
- Education Information.

### **This Personal Information is collected from the following sources:**

- Information we receive from you on applications or other forms;
- Information about your transactions with FNF, our affiliates, or others;
- Information we receive from consumer reporting agencies and/or governmental entities, either directly from these entities or through others;
- Information from the use of our websites and mobile applications.

### **This Personal Information is collected for the following business purposes:**

- To provide products and services to you or in connection with a transaction involving you;
- To perform a contract between FNF and the Consumer;
- To improve our products and services;
- To comply with legal obligations;
- To protect against fraudulent or illegal activity;
- To communicate with you about FNF or our affiliates;
- To maintain an account with FNF or our affiliates;
- To provide, support, personalize, and develop our websites, products, and services;
- As described to you when collecting your personal information or as otherwise set forth in the California Consumer Privacy Act.

**Disclosures of Personal Information for a business purpose:**

In the preceding twelve (12) months FNF has disclosed, and will continue to disclose, the categories of Personal Information listed above for a business purpose. We may disclose Personal Information for a business purpose to the following categories of third parties:

- FNF affiliates and subsidiaries;
- Non-affiliated third parties, as directed by you;
- Businesses in connection with the sale or other disposition of all or part of the FNF business and/or assets;
- Service Providers;
- Law enforcement or authorities in connection with an investigation, or in response to a subpoena or court order.

**Sale of Personal Information:**

In the preceding twelve (12) months, FNF has not sold Personal Information. FNF does not sell Personal Information.

**Personal Information of minors:**

FNF does not knowingly collect the Personal Information of minors.

**Right to know:**

Consumers have a right to know about Personal Information collected, used, disclosed, or sold. Consumers have the right to request FNF disclose what personal information it collected, used, and disclosed in the past twelve (12) months.

**Right to request deletion:**

Consumers have a right to request the deletion of their personal information.

**Right to non-discrimination:**

Consumers have a right not to be discriminated against by exercising their consumer privacy rights. We will not discriminate against Consumers for exercising any of their California Privacy Rights.

**Right to use an Authorized Agent:**

A Consumer may use an Authorized Agent to submit a request to know or a request to delete his or her information. Should a Consumer utilize an Authorized Agent, FNF will require the Consumer provide the agent written permission to make the request and verify his or her identity with FNF.

**To exercise any of your California Privacy Rights, please follow the link "[California Privacy Request](#)" or call Toll Free 888-413-1748.**

Upon making a California Privacy Request, FNF will verify the consumer's identity by requiring an account, loan, escrow number, or other identifying information from the consumer.

The above-rights are subject to any applicable rights and obligations including both Federal and California exemptions rendering FNF, or Personal Information collected by FNF, exempt from certain CCPA requirements.

**FNF website services for mortgage loans:**

Certain FNF companies provide services to mortgage loan servicers, including hosting websites that collect customer information on behalf of mortgage loan servicers (the "Service Websites"). The Service Websites may contain links to both this Privacy Notice and the mortgage loan servicer or lender's privacy notice. The sections of this Privacy Notice describing the categories, sources, and uses of your Personal Information do not apply to the Service Websites. The mortgage loan servicer or lender's privacy notice governs use, disclosure, and access to your Information. FNF does not share Information collected through the Service Websites, except (1) as required or authorized by contract with the mortgage loan servicer or lender, or (2) as required by law or in the good-faith belief that such disclosure is necessary to comply with a legal process or applicable law, to enforce this Privacy Notice, or to protect the rights, property, or safety of FNF or the public.

**California Privacy Notice - Effective Date:**

This California Privacy Notice was last updated on January 14, 2021.

**Contact for more information:**

For questions or concerns about FNF's California Privacy Notice and privacy practices, or to exercise any of your California Privacy Rights, please follow the link "[California Privacy](#)," call Toll Free 888-413-1748, or by mail to the below address. We may use your Personal Information for our affiliates (companies owned by FNF) to directly market to you. If you do not want FNF affiliates to directly market to you, visit FNF's "[Opt Out Page](#)" or contact us by phone at (888) 934-3354, or by mail to:

Fidelity National Financial, Inc.  
601 Riverside Avenue  
Jacksonville, Florida 32204  
Attn: Chief Privacy Officer



## ATTACHMENT ONE

### CALIFORNIA LAND TITLE ASSOCIATION STANDARD COVERAGE POLICY - 1990

#### EXCLUSIONS FROM COVERAGE

The following matters are expressly excluded from the coverage of this policy and the Company will not pay loss or damage, costs, attorneys' fees or expenses which arise by reason of:

1. (a) Any law, ordinance or governmental regulation (including but not limited to building or zoning laws, ordinances, or regulations) restricting, regulating, prohibiting or relating (i) the occupancy, use, or enjoyment of the land; (ii) the character, dimensions or location of any improvement now or hereafter erected on the land; (iii) a separation in ownership or a change in the dimensions or area of the land or any parcel of which the land is or was a part; or (iv) environmental protection, or the effect of any violation of these laws, ordinances or governmental regulations, except to the extent that a notice of the enforcement thereof or a notice of a defect, lien, or encumbrance resulting from a violation or alleged violation affecting the land has been recorded in the public records at Date of Policy.  
(b) Any governmental police power not excluded by (a) above, except to the extent that a notice of the exercise thereof or notice of a defect, lien or encumbrance resulting from a violation or alleged violation affecting the land has been recorded in the public records at Date of Policy.
2. Rights of eminent domain unless notice of the exercise thereof has been recorded in the public records at Date of Policy, but not excluding from coverage any taking which has occurred prior to Date of Policy which would be binding on the rights of a purchaser for value without knowledge.
3. Defects, liens, encumbrances, adverse claims or other matters:
  - (a) whether or not recorded in the public records at Date of Policy, but created, suffered, assumed or agreed to by the insured claimant;
  - (b) not known to the Company, not recorded in the public records at Date of Policy, but known to the insured claimant and not disclosed in writing to the Company by the insured claimant prior to the date the insured claimant became an insured under this policy;
  - (c) resulting in no loss or damage to the insured claimant;
  - (d) attaching or created subsequent to Date of Policy; or
  - (e) resulting in loss or damage which would not have been sustained if the insured claimant had paid value for the insured mortgage or for the estate or interest insured by this policy.
4. Unenforceability of the lien of the insured mortgage because of the inability or failure of the insured at Date of Policy, or the inability or failure of any subsequent owner of the indebtedness, to comply with the applicable doing business laws of the state in which the land is situated.
5. Invalidity or unenforceability of the lien of the insured mortgage, or claim thereof, which arises out of the transaction evidenced by the insured mortgage and is based upon usury or any consumer credit protection or truth in lending law.
6. Any claim, which arises out of the transaction vesting in the insured the estate or interest insured by this policy or the transaction creating the interest of the insured lender, by reason of the operation of federal bankruptcy, state insolvency or similar creditors' rights laws.

#### EXCEPTIONS FROM COVERAGE - SCHEDULE B, PART I

This policy does not insure against loss or damage (and the Company will not pay costs, attorneys' fees or expenses) which arise by reason of:

1. Taxes or assessments which are not shown as existing liens by the records of any taxing authority that levies taxes or assessments on real property or by the public records.  
Proceedings by a public agency which may result in taxes or assessments, or notices of such proceedings, whether or not shown by the records of such agency or by the public records.
2. Any facts, rights, interests, or claims which are not shown by the public records but which could be ascertained by an inspection of the land or which may be asserted by persons in possession thereof.
3. Easements, liens or encumbrances, or claims thereof, not shown by the public records.
4. Discrepancies, conflicts in boundary lines, shortage in area, encroachments, or any other facts which a correct survey would disclose, and which are not shown by the public records.
5. (a) Unpatented mining claims; (b) reservations or exceptions in patents or in Acts authorizing the issuance thereof; (c) water rights, claims or title to water, whether or not the matters excepted under (a), (b) or (c) are shown by the public records.
6. Any lien or right to a lien for services, labor or material not shown by the public records.

**ATTACHMENT ONE  
(CONTINUED)**

**CLTA HOMEOWNER'S POLICY OF TITLE INSURANCE (12-02-13)  
ALTA HOMEOWNER'S POLICY OF TITLE INSURANCE**

**EXCLUSIONS**

In addition to the Exceptions in Schedule B, You are not insured against loss, costs, attorneys' fees, and expenses resulting from:

1. Governmental police power, and the existence or violation of those portions of any law or government regulation concerning:
  - a. building;
  - b. zoning;
  - c. land use;
  - d. improvements on the Land;
  - e. land division; and
  - f. environmental protection.This Exclusion does not limit the coverage described in Covered Risk 8.a., 14, 15, 16, 18, 19, 20, 23 or 27.
2. The failure of Your existing structures, or any part of them, to be constructed in accordance with applicable building codes. This Exclusion does not limit the coverage described in Covered Risk 14 or 15.
3. The right to take the Land by condemning it. This Exclusion does not limit the coverage described in Covered Risk 17.
4. Risks:
  - a. that are created, allowed, or agreed to by You, whether or not they are recorded in the Public Records;
  - b. that are Known to You at the Policy Date, but not to Us, unless they are recorded in the Public Records at the Policy Date;
  - c. that result in no loss to You; or
  - d. that first occur after the Policy Date - this does not limit the coverage described in Covered Risk 7, 8.e., 25, 26, 27 or 28.
5. Failure to pay value for Your Title.
6. Lack of a right:
  - a. to any land outside the area specifically described and referred to in paragraph 3 of Schedule A; and
  - b. in streets, alleys, or waterways that touch the Land.This Exclusion does not limit the coverage described in Covered Risk 11 or 21.
7. The transfer of the Title to You is invalid as a preferential transfer or as a fraudulent transfer or conveyance under federal bankruptcy, state insolvency, or similar creditors' rights laws.
8. Contamination, explosion, fire, flooding, vibration, fracturing, earthquake or subsidence.
9. Negligence by a person or an Entity exercising a right to extract or develop minerals, water, or any other substances.

**LIMITATIONS ON COVERED RISKS**

Your insurance for the following Covered Risks is limited on the Owner's Coverage Statement as follows:

- For Covered Risk 16, 18, 19 and 21, Your Deductible Amount and Our Maximum Dollar Limit of Liability shown in Schedule A.

The deductible amounts and maximum dollar limits shown on Schedule A are as follows:

	<u>Your Deductible Amount</u>	<u>Our Maximum Dollar Limit of Liability</u>
Covered Risk 16:	1.00% of Policy Amount Shown in Schedule A or \$2,500.00 (whichever is less)	\$ 10,000.00
Covered Risk 18:	1.00% of Policy Amount Shown in Schedule A or \$5,000.00 (whichever is less)	\$ 25,000.00
Covered Risk 19:	1.00% of Policy Amount Shown in Schedule A or \$5,000.00 (whichever is less)	\$ 25,000.00
Covered Risk 21:	1.00% of Policy Amount Shown in Schedule A or \$2,500.00 (whichever is less)	\$ 5,000.00

**ATTACHMENT ONE  
(CONTINUED)**

**2006 ALTA LOAN POLICY (06-17-06)**

**EXCLUSIONS FROM COVERAGE**

The following matters are expressly excluded from the coverage of this policy, and the Company will not pay loss or damage, costs, attorneys' fees, or expenses that arise by reason of:

1. (a) Any law, ordinance, permit, or governmental regulation (including those relating to building and zoning) restricting, regulating, prohibiting, or relating to
  - (i) the occupancy, use, or enjoyment of the Land;
  - (ii) the character, dimensions, or location of any improvement erected on the Land;
  - (iii) the subdivision of land; or
  - (iv) environmental protection;or the effect of any violation of these laws, ordinances, or governmental regulations. This Exclusion 1(a) does not modify or limit the coverage provided under Covered Risk 5.
- (b) Any governmental police power. This Exclusion 1(b) does not modify or limit the coverage provided under Covered Risk 6.
2. Rights of eminent domain. This Exclusion does not modify or limit the coverage provided under Covered Risk 7 or 8.
3. Defects, liens, encumbrances, adverse claims, or other matters
  - (a) created, suffered, assumed, or agreed to by the Insured Claimant;
  - (b) not Known to the Company, not recorded in the Public Records at Date of Policy, but Known to the Insured Claimant and not disclosed in writing to the Company by the Insured Claimant prior to the date the Insured Claimant became an Insured under this policy;
  - (c) resulting in no loss or damage to the Insured Claimant;
  - (d) attaching or created subsequent to Date of Policy (however, this does not modify or limit the coverage provided under Covered Risk 11, 13, or 14); or
  - (e) resulting in loss or damage that would not have been sustained if the Insured Claimant had paid value for the Insured Mortgage.
4. Unenforceability of the lien of the Insured Mortgage because of the inability or failure of an Insured to comply with applicable doing-business laws of the state where the Land is situated.
5. Invalidity or unenforceability in whole or in part of the lien of the Insured Mortgage that arises out of the transaction evidenced by the Insured Mortgage and is based upon usury or any consumer credit protection or truth-in-lending law.
6. Any claim, by reason of the operation of federal bankruptcy, state insolvency, or similar creditors' rights laws, that the transaction creating the lien of the Insured Mortgage, is
  - (a) a fraudulent conveyance or fraudulent transfer, or
  - (b) a preferential transfer for any reason not stated in Covered Risk 13(b) of this policy.
7. Any lien on the Title for real estate taxes or assessments imposed by governmental authority and created or attaching between Date of Policy and the date of recording of the Insured Mortgage in the Public Records. This Exclusion does not modify or limit the coverage provided under Covered Risk 11(b).

The above policy form may be issued to afford either Standard Coverage or Extended Coverage. In addition to the above Exclusions from Coverage, the Exceptions from Coverage in a Standard Coverage policy will also include the following Exceptions from Coverage:

**EXCEPTIONS FROM COVERAGE**

[Except as provided in Schedule B - Part II, [ ]his policy does not insure against loss or damage, and the Company will not pay costs, attorneys' fees, or expenses that arise by reason of:

**[PART I**

[The above policy form may be issued to afford either Standard Coverage or Extended Coverage. In addition to the above Exclusions from Coverage, the Exceptions from Coverage in a Standard Coverage policy will also include the following Exceptions from Coverage:

1. (a) Taxes or assessments that are not shown as existing liens by the records of any taxing authority that levies taxes or assessments on real property or by the Public Records; (b) proceedings by a public agency that may result in taxes or assessments, or notices of such proceedings, whether or not shown by the records of such agency or by the Public Records.
2. Any facts, rights, interests, or claims that are not shown by the Public Records but that could be ascertained by an inspection of the Land or that may be asserted by persons in possession of the Land.
3. Easements, liens or encumbrances, or claims thereof, not shown by the Public Records.
4. Any encroachment, encumbrance, violation, variation, or adverse circumstance affecting the Title that would be disclosed by an accurate and complete land survey of the Land and not shown by the Public Records.
5. (a) Unpatented mining claims; (b) reservations or exceptions in patents or in Acts authorizing the issuance thereof; (c) water rights, claims or title to water, whether or not the matters excepted under (a), (b), or (c) are shown by the Public Records.
6. Any lien or right to a lien for services, labor or material not shown by the Public Records.]

**PART II**

In addition to the matters set forth in Part I of this Schedule, the Title is subject to the following matters, and the Company insures against loss or damage sustained in the event that they are not subordinate to the lien of the Insured Mortgage:]

**ATTACHMENT ONE  
(CONTINUED)**

**2006 ALTA OWNER'S POLICY (06-17-06)**

**EXCLUSIONS FROM COVERAGE**

The following matters are expressly excluded from the coverage of this policy, and the Company will not pay loss or damage, costs, attorneys' fees, or expenses that arise by reason of:

1. (a) Any law, ordinance, permit, or governmental regulation (including those relating to building and zoning) restricting, regulating, prohibiting, or relating to
  - (i) the occupancy, use, or enjoyment of the Land;
  - (ii) the character, dimensions, or location of any improvement erected on the Land;
  - (iii) the subdivision of land; or
  - (iv) environmental protection;or the effect of any violation of these laws, ordinances, or governmental regulations. This Exclusion 1(a) does not modify or limit the coverage provided under Covered Risk 5.
- (b) Any governmental police power. This Exclusion 1(b) does not modify or limit the coverage provided under Covered Risk 6.
2. Rights of eminent domain. This Exclusion does not modify or limit the coverage provided under Covered Risk 7 or 8.
3. Defects, liens, encumbrances, adverse claims, or other matters
  - (a) created, suffered, assumed, or agreed to by the Insured Claimant;
  - (b) not Known to the Company, not recorded in the Public Records at Date of Policy, but Known to the Insured Claimant and not disclosed in writing to the Company by the Insured Claimant prior to the date the Insured Claimant became an Insured under this policy;
  - (c) resulting in no loss or damage to the Insured Claimant;
  - (d) attaching or created subsequent to Date of Policy (however, this does not modify or limit the coverage provided under Covered Risk 9 and 10); or
  - (e) resulting in loss or damage that would not have been sustained if the Insured Claimant had paid value for the Title.
4. Any claim, by reason of the operation of federal bankruptcy, state insolvency, or similar creditors' rights laws, that the transaction vesting the Title as shown in Schedule A, is
  - (a) a fraudulent conveyance or fraudulent transfer; or
  - (b) a preferential transfer for any reason not stated in Covered Risk 9 of this policy.
5. Any lien on the Title for real estate taxes or assessments imposed by governmental authority and created or attaching between Date of Policy and the date of recording of the deed or other instrument of transfer in the Public Records that vests Title as shown in Schedule A.

The above policy form may be issued to afford either Standard Coverage or Extended Coverage. In addition to the above Exclusions from Coverage, the Exceptions from Coverage in a Standard Coverage policy will also include the following Exceptions from Coverage:

**EXCEPTIONS FROM COVERAGE**

This policy does not insure against loss or damage, and the Company will not pay costs, attorneys' fees, or expenses that arise by reason of:

[The above policy form may be issued to afford either Standard Coverage or Extended Coverage. In addition to the above Exclusions from Coverage, the Exceptions from Coverage in a Standard Coverage policy will also include the following Exceptions from Coverage:

1. (a) Taxes or assessments that are not shown as existing liens by the records of any taxing authority that levies taxes or assessments on real property or by the Public Records; (b) proceedings by a public agency that may result in taxes or assessments, or notices of such proceedings, whether or not shown by the records of such agency or by the Public Records.
2. Any facts, rights, interests, or claims that are not shown by the Public Records but that could be ascertained by an inspection of the Land or that may be asserted by persons in possession of the Land.
3. Easements, liens or encumbrances, or claims thereof, not shown by the Public Records.
4. Any encroachment, encumbrance, violation, variation, or adverse circumstance affecting the Title that would be disclosed by an accurate and complete land survey of the Land and not shown by the Public Records.
5. (a) Unpatented mining claims; (b) reservations or exceptions in patents or in Acts authorizing the issuance thereof; (c) water rights, claims or title to water, whether or not the matters excepted under (a), (b), or (c) are shown by the Public Records.
6. Any lien or right to a lien for services, labor or material not shown by the Public Records.]
7. [Variable exceptions such as taxes, easements, CC&R's, etc., shown here.]



**ATTACHMENT ONE  
(CONTINUED)**

**ALTA EXPANDED COVERAGE RESIDENTIAL LOAN POLICY - ASSESSMENTS PRIORITY (04-02-15)**

**EXCLUSIONS FROM COVERAGE**

The following matters are expressly excluded from the coverage of this policy and the Company will not pay loss or damage, costs, attorneys' fees or expenses which arise by reason of:

1. (a) Any law, ordinance, permit, or governmental regulation (including those relating to building and zoning) restricting, regulating, prohibiting, or relating to
  - (i) the occupancy, use, or enjoyment of the Land;
  - (ii) the character, dimensions, or location of any improvement erected on the Land;
  - (iii) the subdivision of land; or
  - (iv) environmental protection;or the effect of any violation of these laws, ordinances, or governmental regulations. This Exclusion 1(a) does not modify or limit the coverage provided under Covered Risk 5, 6, 13(c), 13(d), 14 or 16.
- (b) Any governmental police power. This Exclusion 1(b) does not modify or limit the coverage provided under Covered Risk 5, 6, 13(c), 13(d), 14 or 16.
2. Rights of eminent domain. This Exclusion does not modify or limit the coverage provided under Covered Risk 7 or 8.
3. Defects, liens, encumbrances, adverse claims, or other matters
  - (a) created, suffered, assumed, or agreed to by the Insured Claimant;
  - (b) not Known to the Company, not recorded in the Public Records at Date of Policy, but Known to the Insured Claimant and not disclosed in writing to the Company by the Insured Claimant prior to the date the Insured Claimant became an Insured under this policy;
  - (c) resulting in no loss or damage to the Insured Claimant;
  - (d) attaching or created subsequent to Date of Policy (however, this does not modify or limit the coverage provided under Covered Risk 11, 16, 17, 18, 19, 20, 21, 22, 23, 24, 27 or 28); or
  - (e) resulting in loss or damage that would not have been sustained if the Insured Claimant had paid value for the Insured Mortgage.
4. Unenforceability of the lien of the Insured Mortgage because of the inability or failure of an Insured to comply with applicable doing-business laws of the state where the Land is situated.
5. Invalidity or unenforceability in whole or in part of the lien of the Insured Mortgage that arises out of the transaction evidenced by the Insured Mortgage and is based upon usury, or any consumer credit protection or truth-in-lending law. This Exclusion does not modify or limit the coverage provided in Covered Risk 26.
6. Any claim of invalidity, unenforceability or lack of priority of the lien of the Insured Mortgage as to Advances or modifications made after the Insured has Knowledge that the vestee shown in Schedule A is no longer the owner of the estate or interest covered by this policy. This Exclusion does not modify or limit the coverage provided in Covered Risk 11.
7. Any lien on the Title for real estate taxes or assessments imposed by governmental authority and created or attaching subsequent to Date of Policy. This Exclusion does not modify or limit the coverage provided in Covered Risk 11(b) or 25.
8. The failure of the residential structure, or any portion of it, to have been constructed before, on or after Date of Policy in accordance with applicable building codes. This Exclusion does not modify or limit the coverage provided in Covered Risk 5 or 6.
9. Any claim, by reason of the operation of federal bankruptcy, state insolvency, or similar creditors' rights laws, that the transaction creating the lien of the Insured Mortgage, is
  - (a) a fraudulent conveyance or fraudulent transfer, or
  - (b) a preferential transfer for any reason not stated in Covered Risk 27(b) of this policy.
10. Contamination, explosion, fire, flooding, vibration, fracturing, earthquake, or subsidence.
11. Negligence by a person or an Entity exercising a right to extract or develop minerals, water, or any other substances.

## Notice of Available Discounts

Pursuant to Section 2355.3 in Title 10 of the California Code of Regulations Fidelity National Financial, Inc. and its subsidiaries ("FNF") must deliver a notice of each discount available under our current rate filing along with the delivery of escrow instructions, a preliminary report or commitment. Please be aware that the provision of this notice does not constitute a waiver of the consumer's right to be charged the filed rate. As such, your transaction may not qualify for the below discounts.

You are encouraged to discuss the applicability of one or more of the below discounts with a Company representative. These discounts are generally described below; consult the rate manual for a full description of the terms, conditions and requirements for such discount. These discounts only apply to transactions involving services rendered by the FNF Family of Companies. This notice only applies to transactions involving property improved with a one-to-four family residential dwelling.

Not all discounts are offered by every FNF Company. The discount will only be applicable to the FNF Company as indicated by the named discount.

### **FNF Underwritten Title Companies**

CTC - Chicago Title Company  
CLTC - Commonwealth Land Title Company  
FNTC - Fidelity National Title Company of California  
FNTCCA - Fidelity National Title Company of California  
TICOR - Tigor Title Company of California  
LTC - Lawyer's Title Company  
SLTC - ServiceLink Title Company

### **Underwritten by FNF Underwriters**

CTIC - Chicago Title Insurance Company  
CLTIC - Commonwealth Land Title Insurance Company  
FNTIC - Fidelity National Title Insurance Company  
FNTIC - Fidelity National Title Insurance Company  
CTIC - Chicago Title Insurance Company  
CLTIC - Commonwealth Land Title Insurance Company  
CTIC - Chicago Title Insurance Company

### **Available Discounts**

#### **DISASTER LOANS (CTIC, CLTIC, FNTIC)**

The charge for a Lender's Policy (Standard or Extended coverage) covering the financing or refinancing by an owner of record, within twenty-four (24) months of the date of a declaration of a disaster area by the government of the United States or the State of California on any land located in said area, which was partially or totally destroyed in the disaster, will be fifty percent (50%) of the appropriate title insurance rate.

#### **CHURCHES OR CHARITABLE NON-PROFIT ORGANIZATIONS (CTIC, FNTIC)**

On properties used as a church or for charitable purposes within the scope of the normal activities of such entities, provided said charge is normally the church's obligation the charge for an owner's policy shall be fifty percent (50%) to seventy percent (70%) of the appropriate title insurance rate, depending on the type of coverage selected. The charge for a lender's policy shall be forty percent (40%) to fifty percent (50%) of the appropriate title insurance rate, depending on the type of coverage selected.



---

## PRELIMINARY REPORT

**Order No.:** 7102018696-SB  
**Property:** Dahlia 62 & 63 - APN  
#040-340-004-000  
Brawley, CA 92227

*In response to the application for a policy of title insurance referenced herein, **Chicago Title Company** hereby reports that it is prepared to issue, or cause to be issued, as of the date hereof, a policy or policies of title insurance describing the land and the estate or interest therein hereinafter set forth, insuring against loss which may be sustained by reason of any defect, lien or encumbrance not shown or referred to as an exception herein or not excluded from coverage pursuant to the printed Schedules, Conditions and Stipulations or Conditions of said policy forms.*

*The printed Exceptions and Exclusions from the coverage and Limitations on Covered Risks of said policy or policies are set forth in Attachment One. The policy to be issued may contain an arbitration clause. When the Amount of Insurance is less than that set forth in the arbitration clause, all arbitrable matters shall be arbitrated at the option of either the Company or the Insured as the exclusive remedy of the parties. Limitations on Covered Risks applicable to the CLTA and ALTA Homeowner's Policies of Title Insurance which establish a Deductible Amount and a Maximum Dollar Limit of Liability for certain coverages are also set forth in Attachment One. Copies of the policy forms should be read. They are available from the office which issued this report.*

*This report (and any supplements or amendments hereto) is issued solely for the purpose of facilitating the issuance of a policy of title insurance and no liability is assumed hereby. If it is desired that liability be assumed prior to the issuance of a policy of title insurance, a Binder or Commitment should be requested.*

*The policy(ies) of title insurance to be issued hereunder will be policy(ies) of Chicago Title Insurance Company, a Florida corporation.*

***Please read the exceptions shown or referred to herein and the exceptions and exclusions set forth in Attachment One of this report carefully. The exceptions and exclusions are meant to provide you with notice of matters which are not covered under the terms of the title insurance policy and should be carefully considered.***

**It is important to note that this preliminary report is not a written representation as to the condition of title and may not list all liens, defects and encumbrances affecting title to the land.**

**Chicago Title Insurance Company**

Countersigned By:



\_\_\_\_\_  
Authorized Officer or Agent

Date:

  
  
\_\_\_\_\_

By:



\_\_\_\_\_  
Randy Quirk, President

Attest:



\_\_\_\_\_  
Marjorie Nemzura, Secretary



Visit Us on our Website: [www.ctic.com](http://www.ctic.com)



**ISSUING OFFICE:** 1425 Main Street, El Centro, CA 92244

**FOR SETTLEMENT INQUIRIES, CONTACT:**

Chicago Title Company  
1425 W. Main Street • El Centro, CA 92243  
(760)335-3130 • FAX (619)573-1410

**PRELIMINARY REPORT**

**Update: 2**

**Title Officer:** Stacey Benner  
**Email:** [stacey.benner@ctt.com](mailto:stacey.benner@ctt.com)  
**Phone No.:** (760)335-3125  
**Fax No.:** (760)353-1307  
**Title No.:** 7102018696-SB

**Escrow Officer:** Heather Skains  
**Email:** [heather.skains@ctt.com](mailto:heather.skains@ctt.com)  
**Phone No.:** (760)335-3130  
**Fax No.:** (760)352-9410  
**Escrow No.:** 7102018696-HS

**PROPERTY ADDRESS(ES):** Dahlia 62 & 63 - APN #040-340-004-000, Brawley, CA

**EFFECTIVE DATE: November 2, 2021 at 12:00 AM**

The form of policy or policies of title insurance contemplated by this report is:

CLTA Standard Coverage Policy 1990 (04-08-14)

1. The estate or interest in the Land hereinafter described or referred to covered by this Report is:

Fee

2. Title to said estate or interest at the date hereof is vested in:

Ronald E. Martin, an unmarried man, as to an undivided one-half interest and

Beverly A. Martin, Trustee of the Beverly A. Martin Revocable Trust UDT dated December 28, 2010, as to an undivided one-half interest

3. The Land referred to in this Report is described as follows:

**For APN/Parcel ID(s): 040-340-004-000**

Tracts 84 and 87, Township 14 South, Range 14 East, S.B.M., in an unincorporated area of the County of Imperial, State of California, according to the Official Plat thereof.

Excepting therefrom that portion thereof granted to the State of California by deed recorded June 20, 1945 in book 643, page 106 of Official Records.

**AT THE DATE HEREOF, EXCEPTIONS TO COVERAGE IN ADDITION TO THE PRINTED EXCEPTIONS AND EXCLUSIONS IN SAID POLICY FORM WOULD BE AS FOLLOWS:**

1. Property taxes, including any personal property taxes and any assessments collected with taxes are as follows:

Code Area: 069-000  
Tax Identification No.: 040-340-004-000  
Fiscal Year: 2021-2022  
1st Installment: \$1,207.99 Not Paid  
2nd Installment: \$1,207.99 Not Paid  
Land: \$198,210.00  
Improvements: \$8,164.00

2. The lien of supplemental or escaped assessments of property taxes, if any, made pursuant to the provisions of Chapter 3.5 (commencing with Section 75) or Part 2, Chapter 3, Articles 3 and 4, respectively, of the Revenue and Taxation Code of the State of California as a result of the transfer of title to the vestee named in Schedule A or as a result of changes in ownership or new construction occurring prior to Date of Policy.
3. Taxes and assessments levied by the Imperial Irrigation District, if any.
4. Water rights, claims or title to water, whether or not disclosed by the public records.
5. Rights or claims of easements for canals, drains, laterals, irrigation pipelines and gates not recorded in the public record.
6. Title to, and easements in, any portion of the land lying within any highways, roads, streets, or other ways.
7. Easement(s) for the purpose(s) shown below and rights incidental thereto, as granted in a document:

Granted to: State of California  
Purpose: highway purposes  
Recording Date: November 7, 1925  
Recording No.: in book 101, page 17 of Official Records  
Affects: Over and across the Westerly 40 feet of Tract 87.

8. The fact that the ownership of said land only has ingress and egress to or from the highway over and across a 30 foot opening over the Easterly right of way line from Engineer's Station 122+40 to Engineer's Station 122+70, and a 15 foot opening from Engineer's Station 135+25 to the North line of Tract 87, herein described, all other rights having been relinquished to the State of California by deed recorded June 20, 1945 in book 643, page 106 of Official Records.
9. Easement(s) for the purpose(s) shown below and rights incidental thereto, as granted in a document:
- Granted to: Henry L. Jackson, et ux.  
Purpose: To construct and maintain a pipe line.  
Recording Date: August 9, 1947  
Recording No.: in book 681, page 185 of Official Records  
Affects: Over and across the West 5 feet of the West 40 acres of said Tract 87.
10. The fact that the ownership of said land does not include any rights of ingress and egress to or from the highway, over and across that certain 15 foot opening over the Easterly right of way line of said highway, from Engineer's Station 135+25 to the North line of Tract 87, herein described, said rights having been relinquished to the State of California by deed recorded February 21, 1955 in book 903, page 628 of Official Records.

**EXCEPTIONS**  
(continued)

11. Easement(s) for the purpose(s) shown below and rights incidental thereto, as granted in a document:

Granted to: Memory Gardens of Imperial Valley, Inc.  
Purpose: access  
Recording Date: February 21, 1955  
Recording No.: in book 903, page 632 of Official Records  
Affects: Over and across a 15 foot opening over the Easterly right of way line from Engineer's Station 135+25 to the North line of said Tract 87.

12. Easement(s) for the purpose(s) shown below and rights incidental thereto, as granted in a document:

Granted to: Imperial Irrigation District  
Purpose: For the construction, maintenance and/or use of a concrete lined canal or canals, open and/or underground, telephone and/or electric power line or lines, overhead and/or underground, as now exist or as may hereafter be constructed, enlarged or otherwise changed.  
Recording Date: January 21, 1969  
Recording No.: 15 in book 1273, page 177 of Official Records  
Affects: Those portions of Tract 87, and of the South half of Tract 84 lying South a line which is parallel with and 25 feet North of the center line of the concrete lined Dahlia Lateral 8 Canal as constructed across the South side of the above-described property.

13. An unrecorded lease with certain terms, covenants, conditions and provisions set forth therein as disclosed by the document

Entitled: Land Lease  
Lessor: John W. Martin Family Trust B  
Lessee: Veysey Farm, LLC  
Recording No.: Unrecorded

The present ownership of the leasehold created by said lease and other matters affecting the interest of the lessee are not shown herein.

14. Any invalidity or defect in the title of the vestees in the event that the trust referred to herein is invalid or fails to grant sufficient powers to the trustee(s) or in the event there is a lack of compliance with the terms and provisions of the trust instrument.

If title is to be insured in the trustee(s) of a trust, (or if their act is to be insured), this Company will require a Trust Certification pursuant to California Probate Code Section 18100.5.

The Company reserves the right to add additional items or make further requirements after review of the requested documentation.

15. The herein described Land is located in an area frequently subject to Land Conservation Contracts executed pursuant to the Williamson Act (Cal. Govt. Code §§ 51200 et seq.). Land Conservation Contracts restrict the land use to agricultural, recreational, open-space and other compatible uses. If the herein described Land is subject to a Land Conservation Contract, please notify the Title Department.

The Company reserves the right to add additional items and/or make further requirements

**EXCEPTIONS**  
(continued)

16. Any right, interest or claim that may exist, arise or be asserted under or pursuant to the Perishable Agricultural Commodities Act of 1930, as amended, 7 USC 499a et seq., the Packers and Stockyard Act of 1921, as amended, 7 USC 181 et seq., or any similar state laws.
  
17. Please be advised that our search did not disclose any open Deeds of Trust of record. If you should have knowledge of any outstanding obligation, please contact the Title Department immediately for further review prior to closing.

**END OF EXCEPTIONS**



## NOTES

- Note 1.** Notice: Please be aware that due to the conflict between federal and state laws concerning the cultivation, distribution, manufacture or sale of marijuana, the Company is not able to close or insure any transaction involving Land that is associated with these activities.
- Note 2.** If a county recorder, title insurance company, escrow company, real estate broker, real estate agent or association provides a copy of a declaration, governing document or deed to any person, California law requires that the document provided shall include a statement regarding any unlawful restrictions. Said statement is to be in at least 14-point bold face type and may be stamped on the first page of any document provided or included as a cover page attached to the requested document. Should a party to this transaction request a copy of any document reported herein that fits this category, the statement is to be included in the manner described.
- Note 3.** If this company is requested to disburse funds in connection with this transaction, Chapter 598, Statutes of 1989 mandates hold periods for checks deposited to escrow or sub-escrow accounts. The mandatory hold period for cashier's checks, certified checks and teller's checks is one business day after the day deposited. Other checks require a hold period of from two to five business days after the day deposited. In the event that the parties to the contemplated transaction wish to record prior to the time that the funds are available for disbursement (and subject to Company approval), the Company will require the prior written consent of the parties. Upon request, a form acceptable to the company authorizing said early recording may be provided to Escrow for execution.
- Note 4.** Any documents being executed in conjunction with this transaction must be signed in the presence of an authorized Company employee, an authorized employee of an agent, an authorized employee of the insured lender, or by using Bancserv or other approved third-party service. If the above requirements cannot be met, please call the company at the number provided in this report.
- Note 5.** Note: In compliance with the new RESPA regulations, Chicago Title Company will be averaging recording fees for Single Family 1-4 Residential properties. Please contact your Title Officer to obtain the current recording fees. In addition, Chicago Title Company will pay our underwriter 12% of the title premium, as disclosed on lines 1107 and 1108 of the HUD-1.
- Note 6.** The application for title insurance was placed by reference to only a street address or tax identification number. The proposed Insured must confirm that the legal description in this report covers the parcel(s) of Land requested to be insured. If the legal description is incorrect, the proposed Insured must notify the Company and/or the settlement company in order to prevent errors and to be certain that the legal description for the intended parcel(s) of Land will appear on any documents to be recorded in connection with this transaction and on the policy of title insurance.
- Note 7.** Note: Pursuant to Government Code Section 27388.1, as amended and effective as of 1-1-2018, a Documentary Transfer Tax (DTT) Affidavit may be required to be completed and submitted with each document when DTT is being paid or when an exemption is being claimed from paying the tax. If a governmental agency is a party to the document, the form will not be required. DTT Affidavits may be available at a Tax Assessor-County Clerk-Recorder.
- Note 8.** Due to the special requirements of SB 50 (California Public Resources Code Section 8560 et seq.), any transaction that includes the conveyance of title by an agency of the United States must be approved in advance by the Company's State Counsel, Regional Counsel, or one of their designees.
- Note 9.** This Company will require a full copy of the trust agreement and any amendments thereto.

**NOTES**  
(continued)

**Note 10.** The Company will require the following documents for review prior to the issuance of any title insurance predicated upon a conveyance or encumbrance from the entity named below.

Limited Liability Company: Tomcat Development, LLC, a California limited liability company

- a. A copy of its operating agreement, if any, and any and all amendments, supplements and/or modifications thereto, certified by the appropriate manager or member.
- b. If a domestic Limited Liability Company, a copy of its Articles of Organization and all amendment thereto with the appropriate filing stamps.
- c. If the Limited Liability Company is member-managed a full and complete current list of members certified by the appropriate manager or member.
- d. A current dated certificate of good standing from the proper governmental authority of the state in which the entity was created
- e. If less than all members, or managers, as appropriate, will be executing the closing documents, furnish evidence of the authority of those signing.
- f) If Limited Liability Company is a Single Member Entity, a Statement of Information for the Single Member will be required.
- g) Each member and manager of the LLC without an Operating Agreement must execute in the presence of a notary public the Certificate of California LLC (Without an Operating Agreement) Status and Authority form

**END OF NOTES**

**EXHIBIT "A"**  
Legal Description

**For APN/Parcel ID(s): 040-340-004-000**

---

Tracts 84 and 87, Township 14 South, Range 14 East, S.B.M., in an unincorporated area of the County of Imperial, State of California, according to the Official Plat thereof.

Excepting therefrom that portion thereof granted to the State of California by deed recorded June 20, 1945 in book 643, page 106 of Official Records.



Inquire before you wire!

## WIRE FRAUD ALERT

This Notice is not intended to provide legal or professional advice.  
If you have any questions, please consult with a lawyer.

All parties to a real estate transaction are targets for wire fraud and many have lost hundreds of thousands of dollars because they simply relied on the wire instructions received via email, without further verification. **If funds are to be wired in conjunction with this real estate transaction, we strongly recommend verbal verification of wire instructions through a known, trusted phone number prior to sending funds.**

In addition, the following non-exclusive self-protection strategies are recommended to minimize exposure to possible wire fraud.

- **NEVER RELY** on emails purporting to change wire instructions. Parties to a transaction rarely change wire instructions in the course of a transaction.
- **ALWAYS VERIFY** wire instructions, specifically the ABA routing number and account number, by calling the party who sent the instructions to you. **DO NOT** use the phone number provided in the email containing the instructions, use phone numbers you have called before or can otherwise verify. **Obtain the number of relevant parties to the transaction as soon as an escrow account is opened.** **DO NOT** send an email to verify as the email address may be incorrect or the email may be intercepted by the fraudster.
- **USE COMPLEX EMAIL PASSWORDS** that employ a combination of mixed case, numbers, and symbols. Make your passwords greater than eight (8) characters. Also, change your password often and do **NOT** reuse the same password for other online accounts.
- **USE MULTI-FACTOR AUTHENTICATION** for email accounts. Your email provider or IT staff may have specific instructions on how to implement this feature.

For more information on wire-fraud scams or to report an incident, please refer to the following links:

**Federal Bureau of Investigation:**

<http://www.fbi.gov>

**Internet Crime Complaint Center:**

<http://www.ic3.gov>



## **FIDELITY NATIONAL FINANCIAL CALIFORNIA PRIVACY NOTICE**

Fidelity National Financial, Inc. and its majority-owned subsidiary companies (collectively, "FNF," "our," or "we") respect and are committed to protecting your privacy. This California Privacy Notice explains how we collect, use, and disclose Personal Information, when and to whom we disclose such information, and the rights you, as a California resident ("Consumer"), have regarding your Personal Information ("California Privacy Rights"). Some subsidiaries maintain separate California Privacy Notices or privacy statements. If a subsidiary has a separate California Privacy Notice, it will be available on the subsidiary's website, and this California Privacy Notice does not apply.

### **Collection of categories of Personal Information:**

In the preceding twelve (12) months FNF has collected, and will continue to collect, the following categories of Personal Information from you:

- Identifiers such as name, address, telephone number, IP address, email address, account name, social security number, driver's license number, state identification card, financial information, date of birth, or other similar identifiers;
- Characteristics of protected classifications under California or Federal law;
- Commercial information, including records of personal property, products or services purchased, or other purchasing or consuming histories;
- Internet or other electronic network activity information including, but not limited to browsing history, search history, and information regarding a Consumer's interaction with an Internet website;
- Geolocation data;
- Professional or employment information;
- Education Information.

### **This Personal Information is collected from the following sources:**

- Information we receive from you on applications or other forms;
- Information about your transactions with FNF, our affiliates, or others;
- Information we receive from consumer reporting agencies and/or governmental entities, either directly from these entities or through others;
- Information from the use of our websites and mobile applications.

### **This Personal Information is collected for the following business purposes:**

- To provide products and services to you or in connection with a transaction involving you;
- To perform a contract between FNF and the Consumer;
- To improve our products and services;
- To comply with legal obligations;
- To protect against fraudulent or illegal activity;
- To communicate with you about FNF or our affiliates;
- To maintain an account with FNF or our affiliates;
- To provide, support, personalize, and develop our websites, products, and services;
- As described to you when collecting your personal information or as otherwise set forth in the California Consumer Privacy Act.

**Disclosures of Personal Information for a business purpose:**

In the preceding twelve (12) months FNF has disclosed, and will continue to disclose, the categories of Personal Information listed above for a business purpose. We may disclose Personal Information for a business purpose to the following categories of third parties:

- FNF affiliates and subsidiaries;
- Non-affiliated third parties, as directed by you;
- Businesses in connection with the sale or other disposition of all or part of the FNF business and/or assets;
- Service Providers;
- Law enforcement or authorities in connection with an investigation, or in response to a subpoena or court order.

**Sale of Personal Information:**

In the preceding twelve (12) months, FNF has not sold Personal Information. FNF does not sell Personal Information.

**Personal Information of minors:**

FNF does not knowingly collect the Personal Information of minors.

**Right to know:**

Consumers have a right to know about Personal Information collected, used, disclosed, or sold. Consumers have the right to request FNF disclose what personal information it collected, used, and disclosed in the past twelve (12) months.

**Right to request deletion:**

Consumers have a right to request the deletion of their personal information.

**Right to non-discrimination:**

Consumers have a right not to be discriminated against by exercising their consumer privacy rights. We will not discriminate against Consumers for exercising any of their California Privacy Rights.

**Right to use an Authorized Agent:**

A Consumer may use an Authorized Agent to submit a request to know or a request to delete his or her information. Should a Consumer utilize an Authorized Agent, FNF will require the Consumer provide the agent written permission to make the request and verify his or her identity with FNF.

**To exercise any of your California Privacy Rights, please follow the link "[California Privacy Request](#)" or call Toll Free 888-413-1748.**

Upon making a California Privacy Request, FNF will verify the consumer's identity by requiring an account, loan, escrow number, or other identifying information from the consumer.

The above-rights are subject to any applicable rights and obligations including both Federal and California exemptions rendering FNF, or Personal Information collected by FNF, exempt from certain CCPA requirements.

**FNF website services for mortgage loans:**

Certain FNF companies provide services to mortgage loan servicers, including hosting websites that collect customer information on behalf of mortgage loan servicers (the "Service Websites"). The Service Websites may contain links to both this Privacy Notice and the mortgage loan servicer or lender's privacy notice. The sections of this Privacy Notice describing the categories, sources, and uses of your Personal Information do not apply to the Service Websites. The mortgage loan servicer or lender's privacy notice governs use, disclosure, and access to your Information. FNF does not share Information collected through the Service Websites, except (1) as required or authorized by contract with the mortgage loan servicer or lender, or (2) as required by law or in the good-faith belief that such disclosure is necessary to comply with a legal process or applicable law, to enforce this Privacy Notice, or to protect the rights, property, or safety of FNF or the public.

**California Privacy Notice - Effective Date:**

This California Privacy Notice was last updated on January 14, 2021.

**Contact for more information:**

For questions or concerns about FNF's California Privacy Notice and privacy practices, or to exercise any of your California Privacy Rights, please follow the link "[California Privacy](#)," call Toll Free 888-413-1748, or by mail to the below address. We may use your Personal Information for our affiliates (companies owned by FNF) to directly market to you. If you do not want FNF affiliates to directly market to you, visit FNF's "[Opt Out Page](#)" or contact us by phone at (888) 934-3354, or by mail to:

Fidelity National Financial, Inc.  
601 Riverside Avenue  
Jacksonville, Florida 32204  
Attn: Chief Privacy Officer

## ATTACHMENT ONE

### CALIFORNIA LAND TITLE ASSOCIATION STANDARD COVERAGE POLICY - 1990

#### EXCLUSIONS FROM COVERAGE

The following matters are expressly excluded from the coverage of this policy and the Company will not pay loss or damage, costs, attorneys' fees or expenses which arise by reason of:

1. (a) Any law, ordinance or governmental regulation (including but not limited to building or zoning laws, ordinances, or regulations) restricting, regulating, prohibiting or relating (i) the occupancy, use, or enjoyment of the land; (ii) the character, dimensions or location of any improvement now or hereafter erected on the land; (iii) a separation in ownership or a change in the dimensions or area of the land or any parcel of which the land is or was a part; or (iv) environmental protection, or the effect of any violation of these laws, ordinances or governmental regulations, except to the extent that a notice of the enforcement thereof or a notice of a defect, lien, or encumbrance resulting from a violation or alleged violation affecting the land has been recorded in the public records at Date of Policy.
- (b) Any governmental police power not excluded by (a) above, except to the extent that a notice of the exercise thereof or notice of a defect, lien or encumbrance resulting from a violation or alleged violation affecting the land has been recorded in the public records at Date of Policy.
2. Rights of eminent domain unless notice of the exercise thereof has been recorded in the public records at Date of Policy, but not excluding from coverage any taking which has occurred prior to Date of Policy which would be binding on the rights of a purchaser for value without knowledge.
3. Defects, liens, encumbrances, adverse claims or other matters:
  - (a) whether or not recorded in the public records at Date of Policy, but created, suffered, assumed or agreed to by the insured claimant;
  - (b) not known to the Company, not recorded in the public records at Date of Policy, but known to the insured claimant and not disclosed in writing to the Company by the insured claimant prior to the date the insured claimant became an insured under this policy;
  - (c) resulting in no loss or damage to the insured claimant;
  - (d) attaching or created subsequent to Date of Policy; or
  - (e) resulting in loss or damage which would not have been sustained if the insured claimant had paid value for the insured mortgage or for the estate or interest insured by this policy.
4. Unenforceability of the lien of the insured mortgage because of the inability or failure of the insured at Date of Policy, or the inability or failure of any subsequent owner of the indebtedness, to comply with the applicable doing business laws of the state in which the land is situated.
5. Invalidity or unenforceability of the lien of the insured mortgage, or claim thereof, which arises out of the transaction evidenced by the insured mortgage and is based upon usury or any consumer credit protection or truth in lending law.
6. Any claim, which arises out of the transaction vesting in the insured the estate or interest insured by this policy or the transaction creating the interest of the insured lender, by reason of the operation of federal bankruptcy, state insolvency or similar creditors' rights laws.

#### EXCEPTIONS FROM COVERAGE - SCHEDULE B, PART I

This policy does not insure against loss or damage (and the Company will not pay costs, attorneys' fees or expenses) which arise by reason of:

1. Taxes or assessments which are not shown as existing liens by the records of any taxing authority that levies taxes or assessments on real property or by the public records.

Proceedings by a public agency which may result in taxes or assessments, or notices of such proceedings, whether or not shown by the records of such agency or by the public records.
2. Any facts, rights, interests, or claims which are not shown by the public records but which could be ascertained by an inspection of the land or which may be asserted by persons in possession thereof.
3. Easements, liens or encumbrances, or claims thereof, not shown by the public records.
4. Discrepancies, conflicts in boundary lines, shortage in area, encroachments, or any other facts which a correct survey would disclose, and which are not shown by the public records.
5. (a) Unpatented mining claims; (b) reservations or exceptions in patents or in Acts authorizing the issuance thereof; (c) water rights, claims or title to water, whether or not the matters excepted under (a), (b) or (c) are shown by the public records.
6. Any lien or right to a lien for services, labor or material not shown by the public records.



**ATTACHMENT ONE  
(CONTINUED)**

**CLTA HOMEOWNER'S POLICY OF TITLE INSURANCE (12-02-13)  
ALTA HOMEOWNER'S POLICY OF TITLE INSURANCE**

**EXCLUSIONS**

In addition to the Exceptions in Schedule B, You are not insured against loss, costs, attorneys' fees, and expenses resulting from:

1. Governmental police power, and the existence or violation of those portions of any law or government regulation concerning:
  - a. building;
  - b. zoning;
  - c. land use;
  - d. improvements on the Land;
  - e. land division; and
  - f. environmental protection.This Exclusion does not limit the coverage described in Covered Risk 8.a., 14, 15, 16, 18, 19, 20, 23 or 27.
2. The failure of Your existing structures, or any part of them, to be constructed in accordance with applicable building codes. This Exclusion does not limit the coverage described in Covered Risk 14 or 15.
3. The right to take the Land by condemning it. This Exclusion does not limit the coverage described in Covered Risk 17.
4. Risks:
  - a. that are created, allowed, or agreed to by You, whether or not they are recorded in the Public Records;
  - b. that are Known to You at the Policy Date, but not to Us, unless they are recorded in the Public Records at the Policy Date;
  - c. that result in no loss to You; or
  - d. that first occur after the Policy Date - this does not limit the coverage described in Covered Risk 7, 8.e., 25, 26, 27 or 28.
5. Failure to pay value for Your Title.
6. Lack of a right:
  - a. to any land outside the area specifically described and referred to in paragraph 3 of Schedule A; and
  - b. in streets, alleys, or waterways that touch the Land.This Exclusion does not limit the coverage described in Covered Risk 11 or 21.
7. The transfer of the Title to You is invalid as a preferential transfer or as a fraudulent transfer or conveyance under federal bankruptcy, state insolvency, or similar creditors' rights laws.
8. Contamination, explosion, fire, flooding, vibration, fracturing, earthquake or subsidence.
9. Negligence by a person or an Entity exercising a right to extract or develop minerals, water, or any other substances.

**LIMITATIONS ON COVERED RISKS**

Your insurance for the following Covered Risks is limited on the Owner's Coverage Statement as follows:

- For Covered Risk 16, 18, 19 and 21, Your Deductible Amount and Our Maximum Dollar Limit of Liability shown in Schedule A.

The deductible amounts and maximum dollar limits shown on Schedule A are as follows:

	<u>Your Deductible Amount</u>	<u>Our Maximum Dollar Limit of Liability</u>
Covered Risk 16:	1.00% of Policy Amount Shown in Schedule A or \$2,500.00 (whichever is less)	\$ 10,000.00
Covered Risk 18:	1.00% of Policy Amount Shown in Schedule A or \$5,000.00 (whichever is less)	\$ 25,000.00
Covered Risk 19:	1.00% of Policy Amount Shown in Schedule A or \$5,000.00 (whichever is less)	\$ 25,000.00
Covered Risk 21:	1.00% of Policy Amount Shown in Schedule A or \$2,500.00 (whichever is less)	\$ 5,000.00

**ATTACHMENT ONE  
(CONTINUED)**

**2006 ALTA LOAN POLICY (06-17-06)**

**EXCLUSIONS FROM COVERAGE**

The following matters are expressly excluded from the coverage of this policy, and the Company will not pay loss or damage, costs, attorneys' fees, or expenses that arise by reason of:

1. (a) Any law, ordinance, permit, or governmental regulation (including those relating to building and zoning) restricting, regulating, prohibiting, or relating to
  - (i) the occupancy, use, or enjoyment of the Land;
  - (ii) the character, dimensions, or location of any improvement erected on the Land;
  - (iii) the subdivision of land; or
  - (iv) environmental protection;or the effect of any violation of these laws, ordinances, or governmental regulations. This Exclusion 1(a) does not modify or limit the coverage provided under Covered Risk 5.
  - (b) Any governmental police power. This Exclusion 1(b) does not modify or limit the coverage provided under Covered Risk 6.
2. Rights of eminent domain. This Exclusion does not modify or limit the coverage provided under Covered Risk 7 or 8.
3. Defects, liens, encumbrances, adverse claims, or other matters
  - (a) created, suffered, assumed, or agreed to by the Insured Claimant;
  - (b) not Known to the Company, not recorded in the Public Records at Date of Policy, but Known to the Insured Claimant and not disclosed in writing to the Company by the Insured Claimant prior to the date the Insured Claimant became an Insured under this policy;
  - (c) resulting in no loss or damage to the Insured Claimant;
  - (d) attaching or created subsequent to Date of Policy (however, this does not modify or limit the coverage provided under Covered Risk 11, 13, or 14); or
  - (e) resulting in loss or damage that would not have been sustained if the Insured Claimant had paid value for the Insured Mortgage.
4. Unenforceability of the lien of the Insured Mortgage because of the inability or failure of an Insured to comply with applicable doing-business laws of the state where the Land is situated.
5. Invalidity or unenforceability in whole or in part of the lien of the Insured Mortgage that arises out of the transaction evidenced by the Insured Mortgage and is based upon usury or any consumer credit protection or truth-in-lending law.
6. Any claim, by reason of the operation of federal bankruptcy, state insolvency, or similar creditors' rights laws, that the transaction creating the lien of the Insured Mortgage, is
  - (a) a fraudulent conveyance or fraudulent transfer, or
  - (b) a preferential transfer for any reason not stated in Covered Risk 13(b) of this policy.
7. Any lien on the Title for real estate taxes or assessments imposed by governmental authority and created or attaching between Date of Policy and the date of recording of the Insured Mortgage in the Public Records. This Exclusion does not modify or limit the coverage provided under Covered Risk 11(b).

The above policy form may be issued to afford either Standard Coverage or Extended Coverage. In addition to the above Exclusions from Coverage, the Exceptions from Coverage in a Standard Coverage policy will also include the following Exceptions from Coverage:

**EXCEPTIONS FROM COVERAGE**

[Except as provided in Schedule B - Part II, [t[or T]his policy does not insure against loss or damage, and the Company will not pay costs, attorneys' fees, or expenses that arise by reason of:

**[PART I**

[The above policy form may be issued to afford either Standard Coverage or Extended Coverage. In addition to the above Exclusions from Coverage, the Exceptions from Coverage in a Standard Coverage policy will also include the following Exceptions from Coverage:

1. (a) Taxes or assessments that are not shown as existing liens by the records of any taxing authority that levies taxes or assessments on real property or by the Public Records; (b) proceedings by a public agency that may result in taxes or assessments, or notices of such proceedings, whether or not shown by the records of such agency or by the Public Records.
2. Any facts, rights, interests, or claims that are not shown by the Public Records but that could be ascertained by an inspection of the Land or that may be asserted by persons in possession of the Land.
3. Easements, liens or encumbrances, or claims thereof, not shown by the Public Records.
4. Any encroachment, encumbrance, violation, variation, or adverse circumstance affecting the Title that would be disclosed by an accurate and complete land survey of the Land and not shown by the Public Records.
5. (a) Unpatented mining claims; (b) reservations or exceptions in patents or in Acts authorizing the issuance thereof; (c) water rights, claims or title to water, whether or not the matters excepted under (a), (b), or (c) are shown by the Public Records.
6. Any lien or right to a lien for services, labor or material not shown by the Public Records.]

**PART II**

In addition to the matters set forth in Part I of this Schedule, the Title is subject to the following matters, and the Company insures against loss or damage sustained in the event that they are not subordinate to the lien of the Insured Mortgage:]

**ATTACHMENT ONE  
(CONTINUED)**

**2006 ALTA OWNER'S POLICY (06-17-06)**

**EXCLUSIONS FROM COVERAGE**

The following matters are expressly excluded from the coverage of this policy, and the Company will not pay loss or damage, costs, attorneys' fees, or expenses that arise by reason of:

1. (a) Any law, ordinance, permit, or governmental regulation (including those relating to building and zoning) restricting, regulating, prohibiting, or relating to
  - (i) the occupancy, use, or enjoyment of the Land;
  - (ii) the character, dimensions, or location of any improvement erected on the Land;
  - (iii) the subdivision of land; or
  - (iv) environmental protection;or the effect of any violation of these laws, ordinances, or governmental regulations. This Exclusion 1(a) does not modify or limit the coverage provided under Covered Risk 5.
- (b) Any governmental police power. This Exclusion 1(b) does not modify or limit the coverage provided under Covered Risk 6.
2. Rights of eminent domain. This Exclusion does not modify or limit the coverage provided under Covered Risk 7 or 8.
3. Defects, liens, encumbrances, adverse claims, or other matters
  - (a) created, suffered, assumed, or agreed to by the Insured Claimant;
  - (b) not Known to the Company, not recorded in the Public Records at Date of Policy, but Known to the Insured Claimant and not disclosed in writing to the Company by the Insured Claimant prior to the date the Insured Claimant became an Insured under this policy;
  - (c) resulting in no loss or damage to the Insured Claimant;
  - (d) attaching or created subsequent to Date of Policy (however, this does not modify or limit the coverage provided under Covered Risk 9 and 10); or
  - (e) resulting in loss or damage that would not have been sustained if the Insured Claimant had paid value for the Title.
4. Any claim, by reason of the operation of federal bankruptcy, state insolvency, or similar creditors' rights laws, that the transaction vesting the Title as shown in Schedule A, is
  - (a) a fraudulent conveyance or fraudulent transfer; or
  - (b) a preferential transfer for any reason not stated in Covered Risk 9 of this policy.
5. Any lien on the Title for real estate taxes or assessments imposed by governmental authority and created or attaching between Date of Policy and the date of recording of the deed or other instrument of transfer in the Public Records that vests Title as shown in Schedule A.

The above policy form may be issued to afford either Standard Coverage or Extended Coverage. In addition to the above Exclusions from Coverage, the Exceptions from Coverage in a Standard Coverage policy will also include the following Exceptions from Coverage:

**EXCEPTIONS FROM COVERAGE**

This policy does not insure against loss or damage, and the Company will not pay costs, attorneys' fees, or expenses that arise by reason of:

[The above policy form may be issued to afford either Standard Coverage or Extended Coverage. In addition to the above Exclusions from Coverage, the Exceptions from Coverage in a Standard Coverage policy will also include the following Exceptions from Coverage:

1. (a) Taxes or assessments that are not shown as existing liens by the records of any taxing authority that levies taxes or assessments on real property or by the Public Records; (b) proceedings by a public agency that may result in taxes or assessments, or notices of such proceedings, whether or not shown by the records of such agency or by the Public Records.
2. Any facts, rights, interests, or claims that are not shown by the Public Records but that could be ascertained by an inspection of the Land or that may be asserted by persons in possession of the Land.
3. Easements, liens or encumbrances, or claims thereof, not shown by the Public Records.
4. Any encroachment, encumbrance, violation, variation, or adverse circumstance affecting the Title that would be disclosed by an accurate and complete land survey of the Land and not shown by the Public Records.
5. (a) Unpatented mining claims; (b) reservations or exceptions in patents or in Acts authorizing the issuance thereof; (c) water rights, claims or title to water, whether or not the matters excepted under (a), (b), or (c) are shown by the Public Records.
6. Any lien or right to a lien for services, labor or material not shown by the Public Records.]
7. [Variable exceptions such as taxes, easements, CC&R's, etc., shown here.]

## ATTACHMENT ONE (CONTINUED)

### ALTA EXPANDED COVERAGE RESIDENTIAL LOAN POLICY - ASSESSMENTS PRIORITY (04-02-15)

#### EXCLUSIONS FROM COVERAGE

The following matters are expressly excluded from the coverage of this policy and the Company will not pay loss or damage, costs, attorneys' fees or expenses which arise by reason of:

1. (a) Any law, ordinance, permit, or governmental regulation (including those relating to building and zoning) restricting, regulating, prohibiting, or relating to
  - (i) the occupancy, use, or enjoyment of the Land;
  - (ii) the character, dimensions, or location of any improvement erected on the Land;
  - (iii) the subdivision of land; or
  - (iv) environmental protection;or the effect of any violation of these laws, ordinances, or governmental regulations. This Exclusion 1(a) does not modify or limit the coverage provided under Covered Risk 5, 6, 13(c), 13(d), 14 or 16.
- (b) Any governmental police power. This Exclusion 1(b) does not modify or limit the coverage provided under Covered Risk 5, 6, 13(c), 13(d), 14 or 16.
2. Rights of eminent domain. This Exclusion does not modify or limit the coverage provided under Covered Risk 7 or 8.
3. Defects, liens, encumbrances, adverse claims, or other matters
  - (a) created, suffered, assumed, or agreed to by the Insured Claimant;
  - (b) not Known to the Company, not recorded in the Public Records at Date of Policy, but Known to the Insured Claimant and not disclosed in writing to the Company by the Insured Claimant prior to the date the Insured Claimant became an Insured under this policy;
  - (c) resulting in no loss or damage to the Insured Claimant;
  - (d) attaching or created subsequent to Date of Policy (however, this does not modify or limit the coverage provided under Covered Risk 11, 16, 17, 18, 19, 20, 21, 22, 23, 24, 27 or 28); or
  - (e) resulting in loss or damage that would not have been sustained if the Insured Claimant had paid value for the Insured Mortgage.
4. Unenforceability of the lien of the Insured Mortgage because of the inability or failure of an Insured to comply with applicable doing-business laws of the state where the Land is situated.
5. Invalidity or unenforceability in whole or in part of the lien of the Insured Mortgage that arises out of the transaction evidenced by the Insured Mortgage and is based upon usury, or any consumer credit protection or truth-in-lending law. This Exclusion does not modify or limit the coverage provided in Covered Risk 26.
6. Any claim of invalidity, unenforceability or lack of priority of the lien of the Insured Mortgage as to Advances or modifications made after the Insured has Knowledge that the vestee shown in Schedule A is no longer the owner of the estate or interest covered by this policy. This Exclusion does not modify or limit the coverage provided in Covered Risk 11.
7. Any lien on the Title for real estate taxes or assessments imposed by governmental authority and created or attaching subsequent to Date of Policy. This Exclusion does not modify or limit the coverage provided in Covered Risk 11(b) or 25.
8. The failure of the residential structure, or any portion of it, to have been constructed before, on or after Date of Policy in accordance with applicable building codes. This Exclusion does not modify or limit the coverage provided in Covered Risk 5 or 6.
9. Any claim, by reason of the operation of federal bankruptcy, state insolvency, or similar creditors' rights laws, that the transaction creating the lien of the Insured Mortgage, is
  - (a) a fraudulent conveyance or fraudulent transfer, or
  - (b) a preferential transfer for any reason not stated in Covered Risk 27(b) of this policy.
10. Contamination, explosion, fire, flooding, vibration, fracturing, earthquake, or subsidence.
11. Negligence by a person or an Entity exercising a right to extract or develop minerals, water, or any other substances.



## Notice of Available Discounts

Pursuant to Section 2355.3 in Title 10 of the California Code of Regulations Fidelity National Financial, Inc. and its subsidiaries ("FNF") must deliver a notice of each discount available under our current rate filing along with the delivery of escrow instructions, a preliminary report or commitment. Please be aware that the provision of this notice does not constitute a waiver of the consumer's right to be charged the filed rate. As such, your transaction may not qualify for the below discounts.

You are encouraged to discuss the applicability of one or more of the below discounts with a Company representative. These discounts are generally described below; consult the rate manual for a full description of the terms, conditions and requirements for such discount. These discounts only apply to transactions involving services rendered by the FNF Family of Companies. This notice only applies to transactions involving property improved with a one-to-four family residential dwelling.

Not all discounts are offered by every FNF Company. The discount will only be applicable to the FNF Company as indicated by the named discount.

### FNF Underwritten Title Companies

CTC - Chicago Title Company  
CLTC - Commonwealth Land Title Company  
FNTC - Fidelity National Title Company of California  
FNTCCA - Fidelity National Title Company of California  
TICOR - Tigor Title Company of California  
LTC - Lawyer's Title Company  
SLTC - ServiceLink Title Company

### Underwritten by FNF Underwriters

CTIC - Chicago Title Insurance Company  
CLTIC - Commonwealth Land Title Insurance Company  
FNTIC - Fidelity National Title Insurance Company  
FNTIC - Fidelity National Title Insurance Company  
CTIC - Chicago Title Insurance Company  
CLTIC - Commonwealth Land Title Insurance Company  
CTIC - Chicago Title Insurance Company

### Available Discounts

#### **DISASTER LOANS (CTIC, CLTIC, FNTIC)**

The charge for a Lender's Policy (Standard or Extended coverage) covering the financing or refinancing by an owner of record, within twenty-four (24) months of the date of a declaration of a disaster area by the government of the United States or the State of California on any land located in said area, which was partially or totally destroyed in the disaster, will be fifty percent (50%) of the appropriate title insurance rate.

#### **CHURCHES OR CHARITABLE NON-PROFIT ORGANIZATIONS (CTIC, FNTIC)**

On properties used as a church or for charitable purposes within the scope of the normal activities of such entities, provided said charge is normally the church's obligation the charge for an owner's policy shall be fifty percent (50%) to seventy percent (70%) of the appropriate title insurance rate, depending on the type of coverage selected. The charge for a lender's policy shall be forty percent (40%) to fifty percent (50%) of the appropriate title insurance rate, depending on the type of coverage selected.



---

## PRELIMINARY REPORT

**Order No.:** 7102021386-SB  
**Property:** Dahlia 65 - APN#  
040-340-006-000  
El Centro, CA 92243

*In response to the application for a policy of title insurance referenced herein, **Chicago Title Company** hereby reports that it is prepared to issue, or cause to be issued, as of the date hereof, a policy or policies of title insurance describing the land and the estate or interest therein hereinafter set forth, insuring against loss which may be sustained by reason of any defect, lien or encumbrance not shown or referred to as an exception herein or not excluded from coverage pursuant to the printed Schedules, Conditions and Stipulations or Conditions of said policy forms.*

*The printed Exceptions and Exclusions from the coverage and Limitations on Covered Risks of said policy or policies are set forth in Attachment One. The policy to be issued may contain an arbitration clause. When the Amount of Insurance is less than that set forth in the arbitration clause, all arbitrable matters shall be arbitrated at the option of either the Company or the Insured as the exclusive remedy of the parties. Limitations on Covered Risks applicable to the CLTA and ALTA Homeowner's Policies of Title Insurance which establish a Deductible Amount and a Maximum Dollar Limit of Liability for certain coverages are also set forth in Attachment One. Copies of the policy forms should be read. They are available from the office which issued this report.*

*This report (and any supplements or amendments hereto) is issued solely for the purpose of facilitating the issuance of a policy of title insurance and no liability is assumed hereby. If it is desired that liability be assumed prior to the issuance of a policy of title insurance, a Binder or Commitment should be requested.*

*The policy(ies) of title insurance to be issued hereunder will be policy(ies) of Chicago Title Insurance Company, a Florida corporation.*

***Please read the exceptions shown or referred to herein and the exceptions and exclusions set forth in Attachment One of this report carefully. The exceptions and exclusions are meant to provide you with notice of matters which are not covered under the terms of the title insurance policy and should be carefully considered.***

***It is important to note that this preliminary report is not a written representation as to the condition of title and may not list all liens, defects and encumbrances affecting title to the land.***

**Chicago Title Insurance Company**

By:



\_\_\_\_\_  
Randy Quirk, President

Attest:



\_\_\_\_\_  
Marjorie Nemzura, Secretary

Countersigned By:



\_\_\_\_\_  
Authorized Officer or Agent

Date:



Visit Us on our Website: [www.ctic.com](http://www.ctic.com)



**ISSUING OFFICE:** 1425 Main Street, El Centro, CA 92244

**FOR SETTLEMENT INQUIRIES, CONTACT:**

Chicago Title Company  
1425 W. Main Street • El Centro, CA 92243  
(760)335-3130 • FAX (619)573-1410

**PRELIMINARY REPORT**

**Update: 2**

**Title Officer:** Stacey Benner  
**Email:** [stacey.benner@ctt.com](mailto:stacey.benner@ctt.com)  
**Phone No.:** (760)335-3125  
**Fax No.:** (760)353-1307  
**Title No.:** 7102021386-SB

**Escrow Officer:** Heather Skains  
**Email:** [heather.skains@ctt.com](mailto:heather.skains@ctt.com)  
**Phone No.:** (760)335-3130  
**Fax No.:** (760)352-9410  
**Escrow No.:** 7102021386-HS

**PROPERTY ADDRESS(ES):** Dahlia 65 - APN# 040-340-006-000, El Centro, CA

**EFFECTIVE DATE: October 22, 2021 at 12:00 AM**

The form of policy or policies of title insurance contemplated by this report is:

CLTA Standard Coverage Policy 1990 (04-08-14)

1. The estate or interest in the Land hereinafter described or referred to covered by this Report is:

Fee

2. Title to said estate or interest at the date hereof is vested in:

Roger D. Van Groningen and Larinda L. Van Groningen, Trustees of the Van Groningen Living Trust  
dated June 30, 2010

3. The Land referred to in this Report is described as follows:

**For APN/Parcel ID(s): 040-340-006-000**

Those portions of the South half (S 1/2) and the East half (E 1/2) of the North half (N 1/2) of Tract 83, Township 14 South, Range 14 East, S.B.M., in an unincorporated area of the County of Imperial, State of California, according to the Official Plat thereof, lying West of the railroad right of way.



**AT THE DATE HEREOF, EXCEPTIONS TO COVERAGE IN ADDITION TO THE PRINTED EXCEPTIONS AND EXCLUSIONS IN SAID POLICY FORM WOULD BE AS FOLLOWS:**

1. This item intentionally deleted.
2. Property taxes, including any personal property taxes and any assessments collected with taxes are as follows:  

Code Area:	069-000
Tax Identification No.:	040-340-006-000
Fiscal Year:	2021-2022
1st Installment:	\$1,731.63 Not Paid
2nd Installment:	\$1,731.63 Not Paid
Land:	\$266,043.00
Improvements:	\$30,124.00
3. The lien of supplemental or escaped assessments of property taxes, if any, made pursuant to the provisions of Chapter 3.5 (commencing with Section 75) or Part 2, Chapter 3, Articles 3 and 4, respectively, of the Revenue and Taxation Code of the State of California as a result of the transfer of title to the vestee named in Schedule A or as a result of changes in ownership or new construction occurring prior to Date of Policy.
4. Taxes and assessments levied by the Imperial Irrigation District, if any.
5. Water rights, claims or title to water, whether or not disclosed by the public records.
6. Rights or claims of easements for canals, drains, laterals, irrigation pipelines and gates not recorded in the public record.
7. Title to, and easements in, any portion of the land lying within any highways, roads, streets, or other ways.
8. Easement(s) for the purpose(s) shown below and rights incidental thereto, as granted in a document:  

Granted to:	Imperial Water Company No. 1
Purpose:	The right to build, construct, maintain and operate an irrigation ditch or ditches, canal or canals, laterals, water weirs, flumes, pipe lines, main laterals and all other things necessary to maintain and operate an irrigation system on, over and across that part of Tract 83 herein described; also, the right to use the bed of the Alamo or the New River, where, if at all, said land borders on, or is in or across the same, for waste ways, canals, dams, reservoirs or other parts of the general irrigation scheme and system of the Imperial Valley, including the right to construct diverting dams in, and ditches from said rivers, and to follow the beds thereof.
Recording No.:	in book 86, page 309 of Deeds
Affects:	Reference is made to said document for full particulars.
9. Easement(s) for the purpose(s) shown below and rights incidental thereto, as granted in a document:  

Granted to:	Naomi V. Stone
Purpose:	For ditch and private road.
Recording Date:	July 29, 1913
Recording No.:	in book 73, page 316 of Deeds and in book 97, page 384 of Deeds
Affects:	Reference is made to said document for full particulars.
10. Easements and rights of way as shown on that certain Licensed Survey Map recorded in book 10, page 68 of Licensed Survey Maps.

**EXCEPTIONS**  
(continued)

**11. Easement(s) for the purpose(s) shown below and rights incidental thereto as reserved in a document;**

Reserved by: Imperial Irrigation District  
Purpose: For the purpose of constructing and operating a power line and necessary appurtenances attached thereto. Also, all easements and rights of way of record in the name of or heretofore used for irrigation, waste or drainage canals, or power or telephone lines and the right to construct, operate and maintain power and telephone lines upon or over said right of ways, together with a convenient means of ingress and egress thereto.  
Recording Date: February 20, 1946  
Recording No.: 1 of Official Records  
Affects: Reference is made to said document for full particulars.

**12. Easement(s) for the purpose(s) shown below and rights incidental thereto as reserved in a document;**

Reserved by: Imperial Irrigation District  
Purpose: For irrigation, waste or drainage canals, or power or telephone lines, and the right to construct, operate and maintain power and telephone lines upon or over said right of way, together with convenient means of ingress and egress thereto.  
Recording Date: April 16, 1947  
Recording No.: 4 of Official Records  
Affects: Reference is made to said document for full particulars.

**13. Easement(s) for the purpose(s) shown below and rights incidental thereto, as granted in a document:**

Granted to: Imperial Irrigation District  
Purpose: For canal, telephone and/or electric power lines, together with rights and privileges necessary to the full enjoyment thereof, including all necessary or convenient means of ingress and egress to and from said right of way.  
Recording Date: April 16, 1947  
Recording No.: 5 of Official Records  
Affects: Reference is made to said document for full particulars.

**14. Easement(s) for the purpose(s) shown below and rights incidental thereto, as granted in a document:**

Granted to: C.A. Martin, Jean B. Martin, John W. Martin and Joyce F. Martin  
Purpose: For the construction, maintenance and operation of an underground tile line as now exists or may hereafter be constructed, enlarged or otherwise changed, for the purpose of providing a drainage outlet for underground water from Tracts 84 and 87, Township 14 South, Range 14 East, S.B.M.  
Recording Date: February 13, 1969  
Recording No.: 3 in book 1274, page 325 of Official Records  
Affects: Reference is made to said document for full particulars.

**EXCEPTIONS**  
(continued)

15. Easement(s) for the purpose(s) shown below and rights incidental thereto, as granted in a document:

Granted to: Imperial Irrigation District  
Purpose: For the construction, maintenance and/or use of a concrete lined canal or canals, open and/or underground, telephone and/or electric power line or lines, overhead and/or underground, as now exist or as may hereafter be constructed, enlarged or otherwise changed. Any use of said right of way easement shall not determine or limit the extent of the said easement granted herein.  
Recording Date: August 27, 1973  
Recording No.: 63 in book 1352, page 405 of Official Records  
Affects: Reference is made to said document for full particulars.

16. Notwithstanding the insuring clauses of the policy, the company does not insure against loss or damage by reason of a lack of a right of access to and from the land.

17. Any invalidity or defect in the title of the vestees in the event that the trust referred to herein is invalid or fails to grant sufficient powers to the trustee(s) or in the event there is a lack of compliance with the terms and provisions of the trust instrument.

If title is to be insured in the trustee(s) of a trust, (or if their act is to be insured), this Company will require a Trust Certification pursuant to California Probate Code Section 18100.5.

The Company reserves the right to add additional items or make further requirements after review of the requested documentation.

18. The herein described Land is located in an area frequently subject to Land Conservation Contracts executed pursuant to the Williamson Act (Cal. Govt. Code §§ 51200 et seq.). Land Conservation Contracts restrict the land use to agricultural, recreational, open-space and other compatible uses. If the herein described Land is subject to a Land Conservation Contract, please notify the Title Department.

The Company reserves the right to add additional items and/or make further requirements

19. Any right, interest or claim that may exist, arise or be asserted under or pursuant to the Perishable Agricultural Commodities Act of 1930, as amended, 7 USC 499a et seq., the Packers and Stockyard Act of 1921, as amended, 7 USC 181 et seq., or any similar state laws.

20. Please be advised that our search did not disclose any open Deeds of Trust of record. If you should have knowledge of any outstanding obligation, please contact the Title Department immediately for further review prior to closing.

**EXCEPTIONS**  
(continued)

21. In order to complete this report, the Company requires a Statement of Information to be completed by the following party(ies),

Party(ies): All Parties

The Company reserves the right to add additional items or make further requirements after review of the requested Statement of Information.

NOTE: The Statement of Information is necessary to complete the search and examination of title under this order. Any title search includes matters that are indexed by name only, and having a completed Statement of Information assists the Company in the elimination of certain matters which appear to involve the parties but in fact affect another party with the same or similar name. Be assured that the Statement of Information is essential and will be kept strictly confidential to this file.

**END OF EXCEPTIONS**



## NOTES

- Note 1.** Notice: Please be aware that due to the conflict between federal and state laws concerning the cultivation, distribution, manufacture or sale of marijuana, the Company is not able to close or insure any transaction involving Land that is associated with these activities.
- Note 2.** If a county recorder, title insurance company, escrow company, real estate broker, real estate agent or association provides a copy of a declaration, governing document or deed to any person, California law requires that the document provided shall include a statement regarding any unlawful restrictions. Said statement is to be in at least 14-point bold face type and may be stamped on the first page of any document provided or included as a cover page attached to the requested document. Should a party to this transaction request a copy of any document reported herein that fits this category, the statement is to be included in the manner described.
- Note 3.** If this company is requested to disburse funds in connection with this transaction, Chapter 598, Statutes of 1989 mandates hold periods for checks deposited to escrow or sub-escrow accounts. The mandatory hold period for cashier's checks, certified checks and teller's checks is one business day after the day deposited. Other checks require a hold period of from two to five business days after the day deposited. In the event that the parties to the contemplated transaction wish to record prior to the time that the funds are available for disbursement (and subject to Company approval), the Company will require the prior written consent of the parties. Upon request, a form acceptable to the company authorizing said early recording may be provided to Escrow for execution.
- Note 4.** Any documents being executed in conjunction with this transaction must be signed in the presence of an authorized Company employee, an authorized employee of an agent, an authorized employee of the insured lender, or by using Bancserv or other approved third-party service. If the above requirements cannot be met, please call the company at the number provided in this report.
- Note 5.** The application for title insurance was placed by reference to only a street address or tax identification number. The proposed Insured must confirm that the legal description in this report covers the parcel(s) of Land requested to be insured. If the legal description is incorrect, the proposed Insured must notify the Company and/or the settlement company in order to prevent errors and to be certain that the legal description for the intended parcel(s) of Land will appear on any documents to be recorded in connection with this transaction and on the policy of title insurance.
- Note 6.** Note: Pursuant to Government Code Section 27388.1, as amended and effective as of 1-1-2018, a Documentary Transfer Tax (DTT) Affidavit may be required to be completed and submitted with each document when DTT is being paid or when an exemption is being claimed from paying the tax. If a governmental agency is a party to the document, the form will not be required. DTT Affidavits may be available at a Tax Assessor-County Clerk-Recorder.
- Note 7.** Due to the special requirements of SB 50 (California Public Resources Code Section 8560 et seq.), any transaction that includes the conveyance of title by an agency of the United States must be approved in advance by the Company's State Counsel, Regional Counsel, or one of their designees.
- Note 8.** This Company will require a full copy of the trust agreement and any amendments thereto.

**NOTES**  
(continued)

**Note 9.** The Company will require the following documents for review prior to the issuance of any title insurance predicated upon a conveyance or encumbrance from the entity named below.

Limited Liability Company: Tomcat Development LLC, a California limited liability company

- a. A copy of its operating agreement, if any, and any and all amendments, supplements and/or modifications thereto, certified by the appropriate manager or member.
- b. If a domestic Limited Liability Company, a copy of its Articles of Organization and all amendment thereto with the appropriate filing stamps.
- c. If the Limited Liability Company is member-managed a full and complete current list of members certified by the appropriate manager or member.
- d. A current dated certificate of good standing from the proper governmental authority of the state in which the entity was created
- e. If less than all members, or managers, as appropriate, will be executing the closing documents, furnish evidence of the authority of those signing.
- f) If Limited Liability Company is a Single Member Entity, a Statement of Information for the Single Member will be required.
- g) Each member and manager of the LLC without an Operating Agreement must execute in the presence of a notary public the Certificate of California LLC (Without an Operating Agreement) Status and Authority form

**END OF NOTES**

**EXHIBIT "A"**  
Legal Description

**For APN/Parcel ID(s): 040-340-006-000**

---

Those portions of the South half (S 1/2) and the East half (E 1/2) of the North half (N 1/2) of Tract 83, Township 14 South, Range 14 East, S.B.M., in an unincorporated area of the County of Imperial, State of California, according to the Official Plat thereof, lying West of the railroad right of way.



Inquire before you wire!

## WIRE FRAUD ALERT

This Notice is not intended to provide legal or professional advice.  
If you have any questions, please consult with a lawyer.

All parties to a real estate transaction are targets for wire fraud and many have lost hundreds of thousands of dollars because they simply relied on the wire instructions received via email, without further verification. **If funds are to be wired in conjunction with this real estate transaction, we strongly recommend verbal verification of wire instructions through a known, trusted phone number prior to sending funds.**

In addition, the following non-exclusive self-protection strategies are recommended to minimize exposure to possible wire fraud.

- **NEVER RELY** on emails purporting to change wire instructions. Parties to a transaction rarely change wire instructions in the course of a transaction.
- **ALWAYS VERIFY** wire instructions, specifically the ABA routing number and account number, by calling the party who sent the instructions to you. **DO NOT** use the phone number provided in the email containing the instructions, use phone numbers you have called before or can otherwise verify. **Obtain the number of relevant parties to the transaction as soon as an escrow account is opened.** **DO NOT** send an email to verify as the email address may be incorrect or the email may be intercepted by the fraudster.
- **USE COMPLEX EMAIL PASSWORDS** that employ a combination of mixed case, numbers, and symbols. Make your passwords greater than eight (8) characters. Also, change your password often and do **NOT** reuse the same password for other online accounts.
- **USE MULTI-FACTOR AUTHENTICATION** for email accounts. Your email provider or IT staff may have specific instructions on how to implement this feature.

For more information on wire-fraud scams or to report an incident, please refer to the following links:

**Federal Bureau of Investigation:**

<http://www.fbi.gov>

**Internet Crime Complaint Center:**

<http://www.ic3.gov>



**FIDELITY NATIONAL FINANCIAL  
CALIFORNIA PRIVACY NOTICE**

Fidelity National Financial, Inc. and its majority-owned subsidiary companies (collectively, "FNF," "our," or "we") respect and are committed to protecting your privacy. This California Privacy Notice explains how we collect, use, and disclose Personal Information, when and to whom we disclose such information, and the rights you, as a California resident ("Consumer"), have regarding your Personal Information ("California Privacy Rights"). Some subsidiaries maintain separate California Privacy Notices or privacy statements. If a subsidiary has a separate California Privacy Notice, it will be available on the subsidiary's website, and this California Privacy Notice does not apply.

**Collection of categories of Personal Information:**

In the preceding twelve (12) months FNF has collected, and will continue to collect, the following categories of Personal Information from you:

- Identifiers such as name, address, telephone number, IP address, email address, account name, social security number, driver's license number, state identification card, financial information, date of birth, or other similar identifiers;
- Characteristics of protected classifications under California or Federal law;
- Commercial information, including records of personal property, products or services purchased, or other purchasing or consuming histories;
- Internet or other electronic network activity information including, but not limited to browsing history, search history, and information regarding a Consumer's interaction with an Internet website;
- Geolocation data;
- Professional or employment information;
- Education Information.

**This Personal Information is collected from the following sources:**

- Information we receive from you on applications or other forms;
- Information about your transactions with FNF, our affiliates, or others;
- Information we receive from consumer reporting agencies and/or governmental entities, either directly from these entities or through others;
- Information from the use of our websites and mobile applications.

**This Personal Information is collected for the following business purposes:**

- To provide products and services to you or in connection with a transaction involving you;
- To perform a contract between FNF and the Consumer;
- To improve our products and services;
- To comply with legal obligations;
- To protect against fraudulent or illegal activity;
- To communicate with you about FNF or our affiliates;
- To maintain an account with FNF or our affiliates;
- To provide, support, personalize, and develop our websites, products, and services;
- As described to you when collecting your personal information or as otherwise set forth in the California Consumer Privacy Act.

**Disclosures of Personal Information for a business purpose:**

In the preceding twelve (12) months FNF has disclosed, and will continue to disclose, the categories of Personal Information listed above for a business purpose. We may disclose Personal Information for a business purpose to the following categories of third parties:

- FNF affiliates and subsidiaries;
- Non-affiliated third parties, as directed by you;
- Businesses in connection with the sale or other disposition of all or part of the FNF business and/or assets;
- Service Providers;
- Law enforcement or authorities in connection with an investigation, or in response to a subpoena or court order.

**Sale of Personal Information:**

In the preceding twelve (12) months, FNF has not sold Personal Information. FNF does not sell Personal Information.

**Personal Information of minors:**

FNF does not knowingly collect the Personal Information of minors.

**Right to know:**

Consumers have a right to know about Personal Information collected, used, disclosed, or sold. Consumers have the right to request FNF disclose what personal information it collected, used, and disclosed in the past twelve (12) months.

**Right to request deletion:**

Consumers have a right to request the deletion of their personal information.

**Right to non-discrimination:**

Consumers have a right not to be discriminated against by exercising their consumer privacy rights. We will not discriminate against Consumers for exercising any of their California Privacy Rights.

**Right to use an Authorized Agent:**

A Consumer may use an Authorized Agent to submit a request to know or a request to delete his or her information. Should a Consumer utilize an Authorized Agent, FNF will require the Consumer provide the agent written permission to make the request and verify his or her identity with FNF.

**To exercise any of your California Privacy Rights, please follow the link "[California Privacy Request](#)" or call Toll Free 888-413-1748.**

Upon making a California Privacy Request, FNF will verify the consumer's identity by requiring an account, loan, escrow number, or other identifying information from the consumer.

The above-rights are subject to any applicable rights and obligations including both Federal and California exemptions rendering FNF, or Personal Information collected by FNF, exempt from certain CCPA requirements.

**FNF website services for mortgage loans:**

Certain FNF companies provide services to mortgage loan servicers, including hosting websites that collect customer information on behalf of mortgage loan servicers (the "Service Websites"). The Service Websites may contain links to both this Privacy Notice and the mortgage loan servicer or lender's privacy notice. The sections of this Privacy Notice describing the categories, sources, and uses of your Personal Information do not apply to the Service Websites. The mortgage loan servicer or lender's privacy notice governs use, disclosure, and access to your Information. FNF does not share Information collected through the Service Websites, except (1) as required or authorized by contract with the mortgage loan servicer or lender, or (2) as required by law or in the good-faith belief that such disclosure is necessary to comply with a legal process or applicable law, to enforce this Privacy Notice, or to protect the rights, property, or safety of FNF or the public.

**California Privacy Notice - Effective Date:**

This California Privacy Notice was last updated on January 14, 2021.

**Contact for more information:**

For questions or concerns about FNF's California Privacy Notice and privacy practices, or to exercise any of your California Privacy Rights, please follow the link "[California Privacy](#)," call Toll Free 888-413-1748, or by mail to the below address. We may use your Personal Information for our affiliates (companies owned by FNF) to directly market to you. If you do not want FNF affiliates to directly market to you, visit FNF's "[Opt Out Page](#)" or contact us by phone at (888) 934-3354, or by mail to:

Fidelity National Financial, Inc.  
601 Riverside Avenue  
Jacksonville, Florida 32204  
Attn: Chief Privacy Officer

## ATTACHMENT ONE

### CALIFORNIA LAND TITLE ASSOCIATION STANDARD COVERAGE POLICY - 1990

#### EXCLUSIONS FROM COVERAGE

The following matters are expressly excluded from the coverage of this policy and the Company will not pay loss or damage, costs, attorneys' fees or expenses which arise by reason of:

1. (a) Any law, ordinance or governmental regulation (including but not limited to building or zoning laws, ordinances, or regulations) restricting, regulating, prohibiting or relating (i) the occupancy, use, or enjoyment of the land; (ii) the character, dimensions or location of any improvement now or hereafter erected on the land; (iii) a separation in ownership or a change in the dimensions or area of the land or any parcel of which the land is or was a part; or (iv) environmental protection, or the effect of any violation of these laws, ordinances or governmental regulations, except to the extent that a notice of the enforcement thereof or a notice of a defect, lien, or encumbrance resulting from a violation or alleged violation affecting the land has been recorded in the public records at Date of Policy.  
(b) Any governmental police power not excluded by (a) above, except to the extent that a notice of the exercise thereof or notice of a defect, lien or encumbrance resulting from a violation or alleged violation affecting the land has been recorded in the public records at Date of Policy.
2. Rights of eminent domain unless notice of the exercise thereof has been recorded in the public records at Date of Policy, but not excluding from coverage any taking which has occurred prior to Date of Policy which would be binding on the rights of a purchaser for value without knowledge.
3. Defects, liens, encumbrances, adverse claims or other matters:
  - (a) whether or not recorded in the public records at Date of Policy, but created, suffered, assumed or agreed to by the insured claimant;
  - (b) not known to the Company, not recorded in the public records at Date of Policy, but known to the insured claimant and not disclosed in writing to the Company by the insured claimant prior to the date the insured claimant became an insured under this policy;
  - (c) resulting in no loss or damage to the insured claimant;
  - (d) attaching or created subsequent to Date of Policy; or
  - (e) resulting in loss or damage which would not have been sustained if the insured claimant had paid value for the insured mortgage or for the estate or interest insured by this policy.
4. Unenforceability of the lien of the insured mortgage because of the inability or failure of the insured at Date of Policy, or the inability or failure of any subsequent owner of the indebtedness, to comply with the applicable doing business laws of the state in which the land is situated.
5. Invalidity or unenforceability of the lien of the insured mortgage, or claim thereof, which arises out of the transaction evidenced by the insured mortgage and is based upon usury or any consumer credit protection or truth in lending law.
6. Any claim, which arises out of the transaction vesting in the insured the estate or interest insured by this policy or the transaction creating the interest of the insured lender, by reason of the operation of federal bankruptcy, state insolvency or similar creditors' rights laws.

#### EXCEPTIONS FROM COVERAGE - SCHEDULE B, PART I

This policy does not insure against loss or damage (and the Company will not pay costs, attorneys' fees or expenses) which arise by reason of:

1. Taxes or assessments which are not shown as existing liens by the records of any taxing authority that levies taxes or assessments on real property or by the public records.  
Proceedings by a public agency which may result in taxes or assessments, or notices of such proceedings, whether or not shown by the records of such agency or by the public records.
2. Any facts, rights, interests, or claims which are not shown by the public records but which could be ascertained by an inspection of the land or which may be asserted by persons in possession thereof.
3. Easements, liens or encumbrances, or claims thereof, not shown by the public records.
4. Discrepancies, conflicts in boundary lines, shortage in area, encroachments, or any other facts which a correct survey would disclose, and which are not shown by the public records.
5. (a) Unpatented mining claims; (b) reservations or exceptions in patents or in Acts authorizing the issuance thereof; (c) water rights, claims or title to water, whether or not the matters excepted under (a), (b) or (c) are shown by the public records.
6. Any lien or right to a lien for services, labor or material not shown by the public records.



**ATTACHMENT ONE  
(CONTINUED)**

**CLTA HOMEOWNER'S POLICY OF TITLE INSURANCE (12-02-13)  
ALTA HOMEOWNER'S POLICY OF TITLE INSURANCE**

**EXCLUSIONS**

In addition to the Exceptions in Schedule B, You are not insured against loss, costs, attorneys' fees, and expenses resulting from:

1. Governmental police power, and the existence or violation of those portions of any law or government regulation concerning:
  - a. building;
  - b. zoning;
  - c. land use;
  - d. improvements on the Land;
  - e. land division; and
  - f. environmental protection.This Exclusion does not limit the coverage described in Covered Risk 8.a., 14, 15, 16, 18, 19, 20, 23 or 27.
2. The failure of Your existing structures, or any part of them, to be constructed in accordance with applicable building codes. This Exclusion does not limit the coverage described in Covered Risk 14 or 15.
3. The right to take the Land by condemning it. This Exclusion does not limit the coverage described in Covered Risk 17.
4. Risks:
  - a. that are created, allowed, or agreed to by You, whether or not they are recorded in the Public Records;
  - b. that are Known to You at the Policy Date, but not to Us, unless they are recorded in the Public Records at the Policy Date;
  - c. that result in no loss to You; or
  - d. that first occur after the Policy Date - this does not limit the coverage described in Covered Risk 7, 8.e., 25, 26, 27 or 28.
5. Failure to pay value for Your Title.
6. Lack of a right:
  - a. to any land outside the area specifically described and referred to in paragraph 3 of Schedule A; and
  - b. in streets, alleys, or waterways that touch the Land.This Exclusion does not limit the coverage described in Covered Risk 11 or 21.
7. The transfer of the Title to You is invalid as a preferential transfer or as a fraudulent transfer or conveyance under federal bankruptcy, state insolvency, or similar creditors' rights laws.
8. Contamination, explosion, fire, flooding, vibration, fracturing, earthquake or subsidence.
9. Negligence by a person or an Entity exercising a right to extract or develop minerals, water, or any other substances.

**LIMITATIONS ON COVERED RISKS**

Your insurance for the following Covered Risks is limited on the Owner's Coverage Statement as follows:

- For Covered Risk 16, 18, 19 and 21, Your Deductible Amount and Our Maximum Dollar Limit of Liability shown in Schedule A.

The deductible amounts and maximum dollar limits shown on Schedule A are as follows:

	<u>Your Deductible Amount</u>	<u>Our Maximum Dollar Limit of Liability</u>
Covered Risk 16:	1.00% of Policy Amount Shown in Schedule A or \$2,500.00 (whichever is less)	\$ 10,000.00
Covered Risk 18:	1.00% of Policy Amount Shown in Schedule A or \$5,000.00 (whichever is less)	\$ 25,000.00
Covered Risk 19:	1.00% of Policy Amount Shown in Schedule A or \$5,000.00 (whichever is less)	\$ 25,000.00
Covered Risk 21:	1.00% of Policy Amount Shown in Schedule A or \$2,500.00 (whichever is less)	\$ 5,000.00

**ATTACHMENT ONE  
(CONTINUED)**

**2006 ALTA LOAN POLICY (06-17-06)**

**EXCLUSIONS FROM COVERAGE**

The following matters are expressly excluded from the coverage of this policy, and the Company will not pay loss or damage, costs, attorneys' fees, or expenses that arise by reason of:

1. (a) Any law, ordinance, permit, or governmental regulation (including those relating to building and zoning) restricting, regulating, prohibiting, or relating to
  - (i) the occupancy, use, or enjoyment of the Land;
  - (ii) the character, dimensions, or location of any improvement erected on the Land;
  - (iii) the subdivision of land; or
  - (iv) environmental protection;or the effect of any violation of these laws, ordinances, or governmental regulations. This Exclusion 1(a) does not modify or limit the coverage provided under Covered Risk 5.
  - (b) Any governmental police power. This Exclusion 1(b) does not modify or limit the coverage provided under Covered Risk 6.
2. Rights of eminent domain. This Exclusion does not modify or limit the coverage provided under Covered Risk 7 or 8.
3. Defects, liens, encumbrances, adverse claims, or other matters
  - (a) created, suffered, assumed, or agreed to by the Insured Claimant;
  - (b) not Known to the Company, not recorded in the Public Records at Date of Policy, but Known to the Insured Claimant and not disclosed in writing to the Company by the Insured Claimant prior to the date the Insured Claimant became an Insured under this policy;
  - (c) resulting in no loss or damage to the Insured Claimant;
  - (d) attaching or created subsequent to Date of Policy (however, this does not modify or limit the coverage provided under Covered Risk 11, 13, or 14); or
  - (e) resulting in loss or damage that would not have been sustained if the Insured Claimant had paid value for the Insured Mortgage.
4. Unenforceability of the lien of the Insured Mortgage because of the inability or failure of an Insured to comply with applicable doing-business laws of the state where the Land is situated.
5. Invalidity or unenforceability in whole or in part of the lien of the Insured Mortgage that arises out of the transaction evidenced by the Insured Mortgage and is based upon usury or any consumer credit protection or truth-in-lending law.
6. Any claim, by reason of the operation of federal bankruptcy, state insolvency, or similar creditors' rights laws, that the transaction creating the lien of the Insured Mortgage, is
  - (a) a fraudulent conveyance or fraudulent transfer, or
  - (b) a preferential transfer for any reason not stated in Covered Risk 13(b) of this policy.
7. Any lien on the Title for real estate taxes or assessments imposed by governmental authority and created or attaching between Date of Policy and the date of recording of the Insured Mortgage in the Public Records. This Exclusion does not modify or limit the coverage provided under Covered Risk 11(b).

The above policy form may be issued to afford either Standard Coverage or Extended Coverage. In addition to the above Exclusions from Coverage, the Exceptions from Coverage in a Standard Coverage policy will also include the following Exceptions from Coverage:

**EXCEPTIONS FROM COVERAGE**

[Except as provided in Schedule B - Part II, [t[or T]his policy does not insure against loss or damage, and the Company will not pay costs, attorneys' fees, or expenses that arise by reason of:

**[PART I**

[The above policy form may be issued to afford either Standard Coverage or Extended Coverage. In addition to the above Exclusions from Coverage, the Exceptions from Coverage in a Standard Coverage policy will also include the following Exceptions from Coverage:

1. (a) Taxes or assessments that are not shown as existing liens by the records of any taxing authority that levies taxes or assessments on real property or by the Public Records; (b) proceedings by a public agency that may result in taxes or assessments, or notices of such proceedings, whether or not shown by the records of such agency or by the Public Records.
2. Any facts, rights, interests, or claims that are not shown by the Public Records but that could be ascertained by an inspection of the Land or that may be asserted by persons in possession of the Land.
3. Easements, liens or encumbrances, or claims thereof, not shown by the Public Records.
4. Any encroachment, encumbrance, violation, variation, or adverse circumstance affecting the Title that would be disclosed by an accurate and complete land survey of the Land and not shown by the Public Records.
5. (a) Unpatented mining claims; (b) reservations or exceptions in patents or in Acts authorizing the issuance thereof; (c) water rights, claims or title to water, whether or not the matters excepted under (a), (b), or (c) are shown by the Public Records.
6. Any lien or right to a lien for services, labor or material not shown by the Public Records.]

**PART II**

In addition to the matters set forth in Part I of this Schedule, the Title is subject to the following matters, and the Company insures against loss or damage sustained in the event that they are not subordinate to the lien of the Insured Mortgage:]

**ATTACHMENT ONE  
(CONTINUED)**

**2006 ALTA OWNER'S POLICY (06-17-06)**

**EXCLUSIONS FROM COVERAGE**

The following matters are expressly excluded from the coverage of this policy, and the Company will not pay loss or damage, costs, attorneys' fees, or expenses that arise by reason of:

1. (a) Any law, ordinance, permit, or governmental regulation (including those relating to building and zoning) restricting, regulating, prohibiting, or relating to
  - (i) the occupancy, use, or enjoyment of the Land;
  - (ii) the character, dimensions, or location of any improvement erected on the Land;
  - (iii) the subdivision of land; or
  - (iv) environmental protection;or the effect of any violation of these laws, ordinances, or governmental regulations. This Exclusion 1(a) does not modify or limit the coverage provided under Covered Risk 5.
- (b) Any governmental police power. This Exclusion 1(b) does not modify or limit the coverage provided under Covered Risk 6.
2. Rights of eminent domain. This Exclusion does not modify or limit the coverage provided under Covered Risk 7 or 8.
3. Defects, liens, encumbrances, adverse claims, or other matters
  - (a) created, suffered, assumed, or agreed to by the Insured Claimant;
  - (b) not Known to the Company, not recorded in the Public Records at Date of Policy, but Known to the Insured Claimant and not disclosed in writing to the Company by the Insured Claimant prior to the date the Insured Claimant became an Insured under this policy;
  - (c) resulting in no loss or damage to the Insured Claimant;
  - (d) attaching or created subsequent to Date of Policy (however, this does not modify or limit the coverage provided under Covered Risk 9 and 10); or
  - (e) resulting in loss or damage that would not have been sustained if the Insured Claimant had paid value for the Title.
4. Any claim, by reason of the operation of federal bankruptcy, state insolvency, or similar creditors' rights laws, that the transaction vesting the Title as shown in Schedule A, is
  - (a) a fraudulent conveyance or fraudulent transfer; or
  - (b) a preferential transfer for any reason not stated in Covered Risk 9 of this policy.
5. Any lien on the Title for real estate taxes or assessments imposed by governmental authority and created or attaching between Date of Policy and the date of recording of the deed or other instrument of transfer in the Public Records that vests Title as shown in Schedule A.

The above policy form may be issued to afford either Standard Coverage or Extended Coverage. In addition to the above Exclusions from Coverage, the Exceptions from Coverage in a Standard Coverage policy will also include the following Exceptions from Coverage:

**EXCEPTIONS FROM COVERAGE**

This policy does not insure against loss or damage, and the Company will not pay costs, attorneys' fees, or expenses that arise by reason of:

[The above policy form may be issued to afford either Standard Coverage or Extended Coverage. In addition to the above Exclusions from Coverage, the Exceptions from Coverage in a Standard Coverage policy will also include the following Exceptions from Coverage:

1. (a) Taxes or assessments that are not shown as existing liens by the records of any taxing authority that levies taxes or assessments on real property or by the Public Records; (b) proceedings by a public agency that may result in taxes or assessments, or notices of such proceedings, whether or not shown by the records of such agency or by the Public Records.
2. Any facts, rights, interests, or claims that are not shown by the Public Records but that could be ascertained by an inspection of the Land or that may be asserted by persons in possession of the Land.
3. Easements, liens or encumbrances, or claims thereof, not shown by the Public Records.
4. Any encroachment, encumbrance, violation, variation, or adverse circumstance affecting the Title that would be disclosed by an accurate and complete land survey of the Land and not shown by the Public Records.
5. (a) Unpatented mining claims; (b) reservations or exceptions in patents or in Acts authorizing the issuance thereof; (c) water rights, claims or title to water, whether or not the matters excepted under (a), (b), or (c) are shown by the Public Records.
6. Any lien or right to a lien for services, labor or material not shown by the Public Records.]
7. [Variable exceptions such as taxes, easements, CC&R's, etc., shown here.]



**ATTACHMENT ONE  
(CONTINUED)**

**ALTA EXPANDED COVERAGE RESIDENTIAL LOAN POLICY - ASSESSMENTS PRIORITY (04-02-15)  
EXCLUSIONS FROM COVERAGE**

The following matters are expressly excluded from the coverage of this policy and the Company will not pay loss or damage, costs, attorneys' fees or expenses which arise by reason of:

1. (a) Any law, ordinance, permit, or governmental regulation (including those relating to building and zoning) restricting, regulating, prohibiting, or relating to
  - (i) the occupancy, use, or enjoyment of the Land;
  - (ii) the character, dimensions, or location of any improvement erected on the Land;
  - (iii) the subdivision of land; or
  - (iv) environmental protection;or the effect of any violation of these laws, ordinances, or governmental regulations. This Exclusion 1(a) does not modify or limit the coverage provided under Covered Risk 5, 6, 13(c), 13(d), 14 or 16.
- (b) Any governmental police power. This Exclusion 1(b) does not modify or limit the coverage provided under Covered Risk 5, 6, 13(c), 13(d), 14 or 16.
2. Rights of eminent domain. This Exclusion does not modify or limit the coverage provided under Covered Risk 7 or 8.
3. Defects, liens, encumbrances, adverse claims, or other matters
  - (a) created, suffered, assumed, or agreed to by the Insured Claimant;
  - (b) not Known to the Company, not recorded in the Public Records at Date of Policy, but Known to the Insured Claimant and not disclosed in writing to the Company by the Insured Claimant prior to the date the Insured Claimant became an Insured under this policy;
  - (c) resulting in no loss or damage to the Insured Claimant;
  - (d) attaching or created subsequent to Date of Policy (however, this does not modify or limit the coverage provided under Covered Risk 11, 16, 17, 18, 19, 20, 21, 22, 23, 24, 27 or 28); or
  - (e) resulting in loss or damage that would not have been sustained if the Insured Claimant had paid value for the Insured Mortgage.
4. Unenforceability of the lien of the Insured Mortgage because of the inability or failure of an Insured to comply with applicable doing-business laws of the state where the Land is situated.
5. Invalidity or unenforceability in whole or in part of the lien of the Insured Mortgage that arises out of the transaction evidenced by the Insured Mortgage and is based upon usury, or any consumer credit protection or truth-in-lending law. This Exclusion does not modify or limit the coverage provided in Covered Risk 26.
6. Any claim of invalidity, unenforceability or lack of priority of the lien of the Insured Mortgage as to Advances or modifications made after the Insured has Knowledge that the vestee shown in Schedule A is no longer the owner of the estate or interest covered by this policy. This Exclusion does not modify or limit the coverage provided in Covered Risk 11.
7. Any lien on the Title for real estate taxes or assessments imposed by governmental authority and created or attaching subsequent to Date of Policy. This Exclusion does not modify or limit the coverage provided in Covered Risk 11(b) or 25.
8. The failure of the residential structure, or any portion of it, to have been constructed before, on or after Date of Policy in accordance with applicable building codes. This Exclusion does not modify or limit the coverage provided in Covered Risk 5 or 6.
9. Any claim, by reason of the operation of federal bankruptcy, state insolvency, or similar creditors' rights laws, that the transaction creating the lien of the Insured Mortgage, is
  - (a) a fraudulent conveyance or fraudulent transfer, or
  - (b) a preferential transfer for any reason not stated in Covered Risk 27(b) of this policy.
10. Contamination, explosion, fire, flooding, vibration, fracturing, earthquake, or subsidence.
11. Negligence by a person or an Entity exercising a right to extract or develop minerals, water, or any other substances.



## Notice of Available Discounts

Pursuant to Section 2355.3 in Title 10 of the California Code of Regulations Fidelity National Financial, Inc. and its subsidiaries ("FNF") must deliver a notice of each discount available under our current rate filing along with the delivery of escrow instructions, a preliminary report or commitment. Please be aware that the provision of this notice does not constitute a waiver of the consumer's right to be charged the filed rate. As such, your transaction may not qualify for the below discounts.

You are encouraged to discuss the applicability of one or more of the below discounts with a Company representative. These discounts are generally described below; consult the rate manual for a full description of the terms, conditions and requirements for such discount. These discounts only apply to transactions involving services rendered by the FNF Family of Companies. This notice only applies to transactions involving property improved with a one-to-four family residential dwelling.

Not all discounts are offered by every FNF Company. The discount will only be applicable to the FNF Company as indicated by the named discount.

### FNF Underwritten Title Companies

CTC - Chicago Title Company  
CLTC - Commonwealth Land Title Company  
FNTC - Fidelity National Title Company of California  
FNTCCA - Fidelity National Title Company of California  
TICOR - Ticor Title Company of California  
LTC - Lawyer's Title Company  
SLTC - ServiceLink Title Company

### Underwritten by FNF Underwriters

CTIC - Chicago Title Insurance Company  
CLTIC - Commonwealth Land Title Insurance Company  
FNTIC - Fidelity National Title Insurance Company  
FNTIC - Fidelity National Title Insurance Company  
CTIC - Chicago Title Insurance Company  
CLTIC - Commonwealth Land Title Insurance Company  
CTIC - Chicago Title Insurance Company

### Available Discounts

#### **DISASTER LOANS (CTIC, CLTIC, FNTIC)**

The charge for a Lender's Policy (Standard or Extended coverage) covering the financing or refinancing by an owner of record, within twenty-four (24) months of the date of a declaration of a disaster area by the government of the United States or the State of California on any land located in said area, which was partially or totally destroyed in the disaster, will be fifty percent (50%) of the appropriate title insurance rate.

#### **CHURCHES OR CHARITABLE NON-PROFIT ORGANIZATIONS (CTIC, FNTIC)**

On properties used as a church or for charitable purposes within the scope of the normal activities of such entities, provided said charge is normally the church's obligation the charge for an owner's policy shall be fifty percent (50%) to seventy percent (70%) of the appropriate title insurance rate, depending on the type of coverage selected. The charge for a lender's policy shall be forty percent (40%) to fifty percent (50%) of the appropriate title insurance rate, depending on the type of coverage selected.

**OWNER'S AFFIDAVIT**

In the event the applicant is not owner, the following shall be signed and acknowledge by the owner.

Permission is hereby granted to Tomcat Development LLC to apply for  
(Lessee, Tenant, Contractor-Specify)  
any and all permits, applications and CEQA actions on the described property located at address  
(State permit type clearly i.e. building, land used)

TR 83 POR E 120AC TR 83 14-14 84.30AC W of SPRR Further Identified by Assessor's Parcel Number

(APN) 040-340-006 is hereby granted.

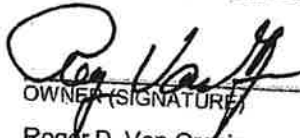
  
OWNER (SIGNATURE)

Roger D. Van Groningen  
OWNER (TYPED OR PRINT)

8000 E. Memory Ave  
OWNER'S ADDRESS

1/12/21  
DATE

A notary public or other officer completing this certificate verifies only the identity of the individual who signed the document to which this certificate is attached, and not the truthfulness, accuracy, or validity of that document.

STATE OF CALIFORNIA  
COUNTY OF Imperial ~~XXXX~~ FRESNO } S.S.

On JANUARY 12, 2021

JULIE SANFILIPPO-ABATE, NOTARY PUBLIC,  
ROGER D. VAN GRONINGEN before me, personally appeared who proved to me on the basis of satisfactory evidence to be the person(s) whose name(s) is/are subscribed to the within instrument and acknowledged to me that he/she/they executed the same in his/her/their authorized capacity(ies), and that by his/her/their signature(s) on the instrument the person(s), or the entity upon behalf of which the person(s) acted, executed the instrument.

I certify under PENALTY OF PERJURY under the laws of the State of California that the foregoing paragraph is true and correct.

WITNESS my hand and official seal.

Signature Julie Sanfilippo Abate

**ATTENTION NOTARY:** Although the information requested below is OPTIONAL, it could prevent fraudulent attachment of this certificate to unauthorized document.

Title or Type of Document OWNER'S AFFIDAVIT  
Number of Pages 1 Date of Document 01/12/2021  
Signer(s) Other Than Named Above NONE





OWNER'S AFFIDAVIT

In the event the applicant is not owner, the following shall be signed and acknowledge by the owner.

Permission is hereby granted to Tomcat Development LLC to apply for  
(Lessee, Tenant, Contractor-Specify)

any and all permits, applications and CEQA actions on the described property located at address  
(State permit type clearly i.e. building, land used)

TR 83 POR E 120AC TR 83 14-14 84.30AC W of SPRR Further identified by Assessor's Parcel Number

(APN) 040-340-006 is hereby granted.

Larinda L. Van Groningen  
OWNER (SIGNATURE)

Larinda L. Van Groningen  
OWNER (TYPED OR PRINT)

5612 W. Clinton Ave, Fresno, CA  
OWNER'S ADDRESS

1/12/21  
DATE

A notary public or other officer completing this certificate verifies only the identity of the individual who signed the document to which this certificate is attached, and not the truthfulness, accuracy, or validity of that document.

STATE OF CALIFORNIA  
COUNTY OF ~~KINGS~~ FRESNO ) S.S.

On JANUARY 12, 2021 before me,  
JULIE SANFILIPPO-ABATE, NOTARY PUBLIC personally appeared  
LARINDA L. VAN GRONINGEN, who proved to me on the basis of satisfactory evidence to be the person(s) whose name(s) is/are subscribed to the within instrument and acknowledged to me that he/she/they executed the same in his/her/their authorized capacity(ies), and that by his/her/their signature(s) on the instrument the person(s), or the entity upon behalf of which the person(s) acted, executed the instrument.

I certify under PENALTY OF PERJURY under the laws of the State of California that the foregoing paragraph is true and correct.

WITNESS my hand and official seal.

Signature Julie Sanfilippo Abate

**ATTENTION NOTARY:** Although the information requested below is OPTIONAL, it could prevent fraudulent attachment of this certificate to unauthorized document.

Title or Type of Document OWNER'S AFFIDAVIT  
Number of Pages ONE Date of Document 01/12/2021  
Signer(s) Other Than Named Above NONE



OWNER'S AFFIDAVIT

In the event the applicant is not owner, the following shall be signed and acknowledge by the owner.

Permission is hereby granted to Tomcat Development LLC (Lessee, Tenant, Contractor-Specify) to apply for any and all permits, applications and CEQA actions on the described property located at address Tracts 84 & 87, Section 31, T 14S, R 14E, unincorporated Imperial County, S.B.B.M Further identified by Assessor's Parcel Number (APN) 040-340-004 is hereby granted.

Beverly A. Martin, Trustee  
OWNER (SIGNATURE)  
Beverly A. Martin, Trustee  
OWNER (TYPED OR PRINT)  
15504 Calle Asturias  
OWNER'S ADDRESS  
12/26/2020  
DATE

A notary public or other officer completing this certificate verifies only the identity of the individual who signed the document to which this certificate is attached, and not the truthfulness, accuracy, or validity of that document.

STATE OF CALIFORNIA  
COUNTY OF San Diego } S.S.

On DEC. 26, 2020 before me, personally appeared JOUNG HEE KIM, Notary public who proved to me on the basis of satisfactory evidence to be the person(s) whose name(s) is/are subscribed to the within instrument and acknowledged to me that he/she/they executed the same in his/her/their authorized capacity(ies), and that by his/her/their signature(s) on the instrument the person(s), or the entity upon behalf of which the person(s) acted, executed the instrument.

I certify under PENALTY OF PERJURY under the laws of the State of California that the foregoing paragraph is true and correct.

WITNESS my hand and official seal.

Signature [Signature]



ATTENTION NOTARY: Although the information requested below is OPTIONAL, it could prevent fraudulent attachment of this certificate to unauthorized document.

Title or Type of Document Owner's Affidavit  
Number of Pages 1 Date of Document 12/26/2020  
Signer(s) Other Than Named Above N/A



OWNER'S AFFIDAVIT

In the event the applicant is not owner, the following shall be signed and acknowledge by the owner.

Permission is hereby granted to Tomcat Development LLC to apply for  
(Lessee, Tenant, Contractor-Specify)

any and all permits, applications and CEQA actions \_\_\_\_\_ on the described property located at address  
(State permit type clearly i.e. building, land used)

Tracts 84 & 87, Section 31, T 14S, R 14E, unincorporated Imperial County, S.B.B.M Further identified by Assessor's Parcel Number

(APN) 040-340-004 is hereby granted.

Ronald E. Martin  
OWNER (SIGNATURE)

Ronald E. Martin  
OWNER (TYPED OR PRINT)

4228 Conner Ct San Diego, CA 92117  
OWNER'S ADDRESS

12/29/20  
DATE

A notary public or other officer completing this certificate verifies only the identity of the individual who signed the document to which this certificate is attached, and not the truthfulness, accuracy, or validity of that document.

STATE OF CALIFORNIA  
COUNTY OF Imperial SAN DIEGO } S.S.

On 12/29/2020 before me,  
J.W. SMITH, NOTARY PUBLIC personally appeared  
RONALD E. MARTIN, who proved to me on the basis of satisfactory evidence to  
be the person(s) whose name(s) is/are subscribed to the within instrument and acknowledged to me that he/she/they  
executed the same in his/her/their authorized capacity(ies), and that by his/her/their signature(s) on the instrument the  
person(s), or the entity upon behalf of which the person(s) acted, executed the instrument.

I certify under PENALTY OF PERJURY under the laws of the State of California that the foregoing paragraph is true and correct.

WITNESS my hand and official seal.

Signature \_\_\_\_\_



**ATTENTION NOTARY:** Although the information requested below is OPTIONAL, it could prevent fraudulent attachment of this certificate to unauthorized document.

Title or Type of Document \_\_\_\_\_  
Number of Pages \_\_\_\_\_ Date of Document \_\_\_\_\_  
Signer(s) Other Than Named Above \_\_\_\_\_

EEC ORIGINAL PKG





# Imperial County Planning & Development Services Planning / Building / Parks & Recreation

**Jim Minnick**  
DIRECTOR

## NOTICE TO APPLICANT

**SUBJECT: PAYMENT OF FEES**

Dear Applicant:

Pursuant to County Codified Ordinance Division 9, Chapter 1, Section 90901.02, all Land Use Applications must be submitted with their appropriate application fee. Failure to comply will cause application to be rejected.

Please note that once the Department application is received and accepted, a "time track" billing will commence immediately. Therefore, should you decide to cancel or withdraw your project at any time, the amount of time incurred against your project will be billed and deducted from your payment. As a consequence, if you request a refund pursuant to County Ordinance, your refund, if any, will be the actual amount paid minus all costs incurred against the project.

Please note there will be no exceptions to this policy. Thank you for your attention.

Sincerely yours,

Jim Minnick, Director  
Planning & Development Services

RECEIVED BY: \_\_\_\_\_ DATE: 11-16-2021

John Moiola, Board Member & Co-founder  
Tomcat Development LLC



# IMPERIAL COUNTY PLANNING & DEVELOPMENT SERVICES GENERAL INDEMNIFICATION AGREEMENT

As part of this application, applicant and real party in interest, if different, agree to defend, indemnify, hold harmless, and release the County of Imperial ("County"), its agents, officers, attorneys, and employees (including consultants) from any claim, action, or proceeding brought against any of them, the purpose of which is to attack, set aside, void, or annul the approval of this application or adoption of the environmental document which accompanies it. This indemnification obligation shall include, but not be limited to, damages, costs, expenses, attorney fees, or expert witness fees that may be asserted by any person or entity, including the applicant, arising out of or in connection with the approval of this application, whether or not there is concurrent negligence on the part of the County, its agents, officers, attorneys, or employees (including consultants).

If any claim, action, or proceeding is brought against the County, its agents, officers, attorneys, or employees (including consultants), to attack, set aside, void, or annul the approval of the application or adoption of the environmental document which accompanies it, then the following procedures shall apply:

1. The Planning Director shall promptly notify the County Board of Supervisors of any claim, action or proceeding brought by an applicant challenging the County's action. The County, its agents, attorneys and employees (including consultants) shall fully cooperate in the defense of that action.
2. The County shall have the final determination on how to best defend the case and will consult with applicant regularly regarding status and the plan for defense. The County will also consult and discuss with applicant the counsel to be used by County to defend it, either with in-house counsel, or by retaining outside counsel provided that the County shall have the final decision on the counsel retained to defend it. Applicant shall be fully responsible for all costs incurred. Applicant shall be entitled to provide his or her own counsel to defend the case, and said independent counsel shall work with County Counsel to provide a joint defense.

Executed at Brawley California on November 16, 2021

**APPLICANT**

Name: Tomcat Development LLC  
 By John Moiola  
 Title Board Member & Co-founder

Mailing Address:

1594 Gonder Road  
Brawley, CA 92227

**REAL PARTY IN INTEREST**  
(If different from Applicant)

Name \_\_\_\_\_  
 By \_\_\_\_\_  
 Title \_\_\_\_\_

Mailing Address:

\_\_\_\_\_  
 \_\_\_\_\_  
 \_\_\_\_\_

ACCEPTED/RECEIVED BY \_\_\_\_\_ Date \_\_\_\_\_

PROJECT ID NO \_\_\_\_\_ APN \_\_\_\_\_

S:\FORMS \_ LIST\General Indemnification FORM 041516.doc

EEC ORIGINAL PKG



**Tomcat Development LLC**  
1594 Gonder Road  
Brawley, CA 92227

## **Project Profile**

Date: 11-16-2021

**Name:** Tomcat Grain Elevator and Rail System

**Owner:** Tomcat Development LLC, a California limited liability company

**Location:** The area North of Dahlia Lateral 8, West of the Union Pacific Rail Road, East of SR-86 and South of IID Newside Drain No. 1-A in the unincorporated County of Imperial

**Size:** Approximately 285 Gross Acres

**APNs:** 040-340-004, -006, -032 & -033

**Legal Description:** Tracts 83, 84, 86 & 87, T 14S, R 14E in the Mesquite Lake Specific Plan area of the unincorporated County of Imperial, lying west of the Union Pacific Rail Road.

**CEQA Lead Agency:** Imperial County Planning & Development Services

**County Applications:**

1. Change of Zone for portion of site to ML – I-3
2. Specific Plan Amendment for portion of site to Heavy Industrial land use
3. Tentative Tract Map including grant of road right-of-way to Imperial County for 88' Industrial Collector

**Description:** The site includes 2 proposed loop tracks that tie into the adjacent Union Pacific Rail Road right-of-way, including a ladder track ("rail system"). The rail system will facilitate in-bound and out-bound trains with commodities as well as transloading to and from trucks. The site includes a grain elevator for receiving and distributing corn and similar feed products for consumption by cattle feeder yards and similar. Access to the site will be via its 2 historical/prescriptive access points to State Route 86, and via a new N-S running 88' Industrial Collector, which will connect to Harris Road to the South. The Memory Gardens Cemetery is part of the subject property, but its property lines are being adjusted for inclusion of a veterans memorial park facility east of and adjacent to the cemetery, then it will be fenced off from the balance of the project area. The remaining portion of the project area that is not occupied by the rail system, the grain elevator and the expanded cemetery property will be used for the transloading and storage of additional commodities. Development standards and hours of operation on-site will be consistent with those of the Mesquite Lake Specific Plan and/or in accordance with Imperial County Planning & Development Services. The entire project area will drain into 1 communal storm water retention basin that connects to the IID Newside Drain No. 1-A.





**Tomcat Development LLC**  
1594 Gonder Road  
Brawley, CA 92227

November 16, 2021

Mr. Jim Minnick  
Planning Director  
County of Imperial  
801 Main Street  
El Centro, CA 92243

Subject: Tomcat Development LLC – Specific Plan Amendment, Zone Change and Tentative Tract Map

Dear Mr. Minnick,

Tomcat Development LLC (“Tomcat”) is developing a grain elevator and rail system for commodity transloading and storage on the area generally described as APNs 040-340-004, -006, -032 & -033 lying on Tracts 83, 84, 86 and 87 between SR 86 and the Union Pacific Rail Road in T 14S, R 14E in an unincorporated area of Imperial County within the Mesquite Lake Specific Plan Area a.k.a. Keystone Planning Area. The project area is approximately 285 gross acres.

Tomcat hereby elects to apply for an amendment to the Mesquite Lake Specific Plan in order to modify the specific plan’s land use plan for the portion of Tomcat’s project area that does not currently have a heavy industrial land use designation so that Tomcat can build and operate its grain elevator and rail system for commodity transloading and storage. Please see the attached Exhibit.

Accompanying the Specific Plan Amendment is Tomcat’s Zone Change Application for conversion of ML GS and ML I-2 zoned land to ML I-3.

Also accompanying the above-mentioned applications is Tomcat’s Tentative Tract Map application in order to re-configure the project area’s existing parcels, and a grant of road right-of-way to Imperial County for an Industrial Collector, as defined in the Mesquite Lake Specific Plan.

We look forward to working with Imperial County Planning & Development Services on this project. Please contact me at 760-455-0399 or [john@moiolabros.com](mailto:john@moiolabros.com) should you have any questions.

Sincerely,  
***Tomcat Development LLC***

**John Moiola**  
Board Member & Co-founder

Attachment: Specific Plan Amendment Request Location Exhibit



# Attachment to Tomcat Development LLC's SPA Request Letter

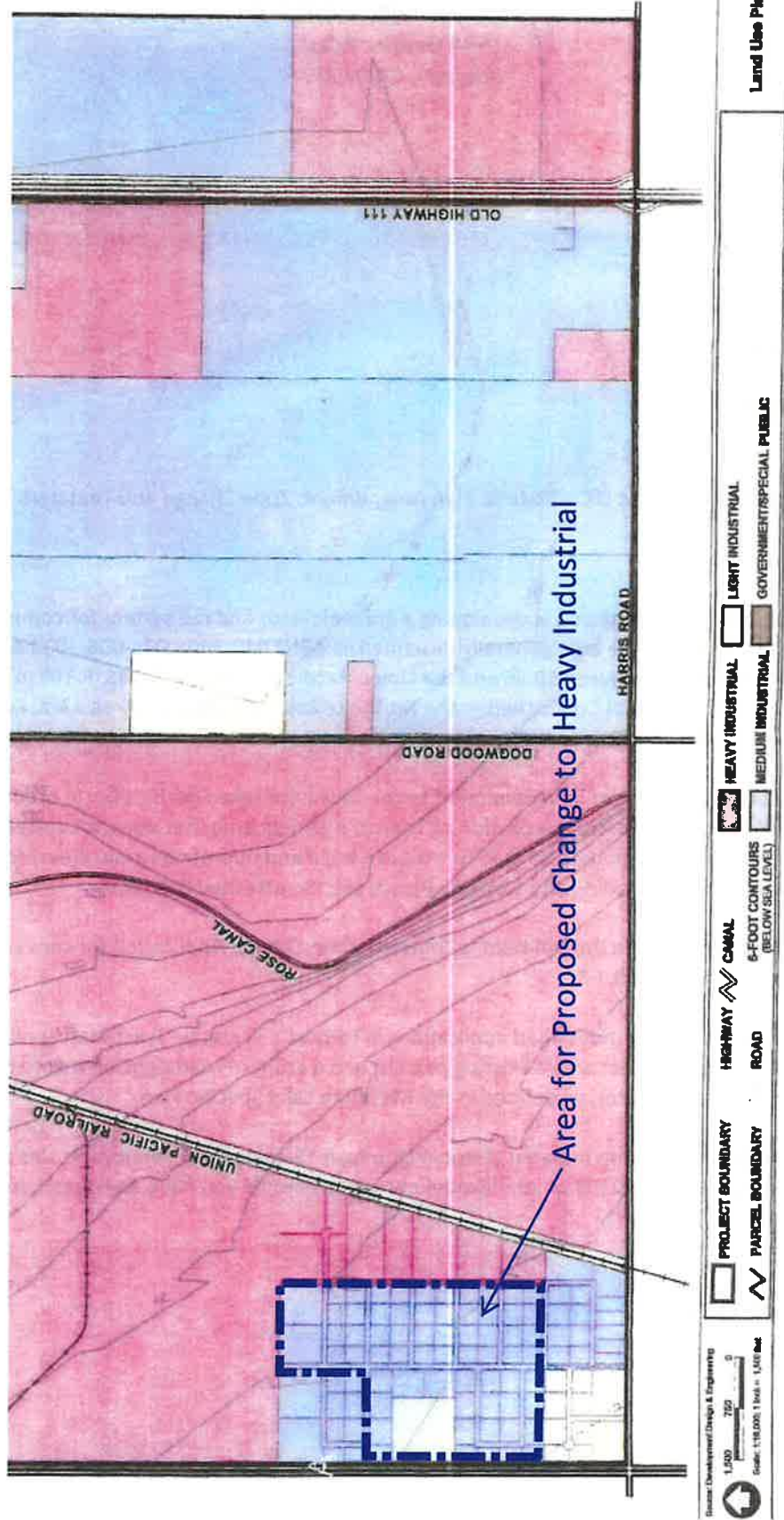

EEC ORIGINAL PKG

# VARIANCE

I.C. PLANNING & DEVELOPMENT SERVICES DEPT.  
801 Main Street, El Centro, CA 92243 (442) 265-1736

- APPLICANT MUST COMPLETE ALL NUMBERED (black) SPACES - Please type or print -

1. PROPERTY OWNER'S NAME Tomcat Development LLC	EMAIL ADDRESS john@moiolabros.com	
2. MAILING ADDRESS (Street / P O Box, City, State) PO Box 177, Brawley, CA	ZIP CODE 92227	PHONE NUMBER 760-455-0399
3. ENGINEERS NAME	CA. LICENSE NO.	EMAIL ADDRESS
4. MAILING ADDRESS (Street / P O Box, City, State)	ZIP CODE	PHONE NUMBER

5. ASSESSOR'S PARCEL NO. 040-340-004, -006, -032, -033	ZONING (existing) ML GS, ML I-2 & ML I-3
6. PROPERTY (site) ADDRESS 3320 State Route 86, Imperial, CA 92251	SIZE OF PROPERTY (in acres or square foot) 284 acres
7. GENERAL LOCATION (i.e. city, town, cross street) Westerly portion of the Keystone Planning Area north of Harris Road and west of the Union Pacific Rail Road	
8. LEGAL DESCRIPTION Tracts 83, 84, 86 and 87 between SR 86 and the Union Pacific Rail Road in T 14S, R 14E in an unincorporated area of Imperial County within the Mesquite Lake Specific Plan Area a.k.a. Keystone Planning Area.	

8. DESCRIBE VARIANCE REQUESTED (i.e. side yard set-back reduction, etc.)

A variance request for any structures over 80 feet, which would include the grain elevator system that will be up to 180 feet tall and comprised of up to eight large tanks/bins.

9. DESCRIBE REASON FOR, OR WHY VARIANCE IS NECESSARY :

A variance is necessary in order to develop an industry standard grain elevator and other site structures that are economically viable.

10. DESCRIBE THE ADJACENT PROPERTY

East	Union Pacific rail road
West	SR-86
North	Spreckles Sugar plant
South	Industrial zoned land

I / WE THE LEGAL OWNER (S) OF THE ABOVE PROPERTY CERTIFY THAT THE INFORMATION SHOWN OR STATED HEREIN IS TRUE AND CORRECT.

John Molola, Manager of Tomcat Development LLC 7-6-23

Print Name \_\_\_\_\_ Date \_\_\_\_\_

Signature \_\_\_\_\_

Print Name \_\_\_\_\_ Date \_\_\_\_\_

Signature \_\_\_\_\_

### REQUIRED SUPPORT DOCUMENTS

A. SITE PLAN	_____
B. FEE	_____
C. OTHER	_____
D. OTHER	_____

APPLICATION RECEIVED BY: _____	DATE _____	REVIEW / APPROVAL BY OTHER DEPT'S required.
APPLICATION DEEMED COMPLETE BY: _____	DATE _____	<input type="checkbox"/> P. W.
APPLICATION REJECTED BY: _____	DATE _____	<input type="checkbox"/> E. H. S.
TENTATIVE HEARING BY: _____	DATE _____	<input type="checkbox"/> A. P. C. D.
FINAL ACTION: <input type="checkbox"/> APPROVED <input type="checkbox"/> DENIED	DATE _____	<input type="checkbox"/> O. E. S.
		<input type="checkbox"/> _____

V #  
23-0007

## SITE PLAN REQUIREMENTS

### PLAN MUST:

- a. be drawn to scale upon substantial paper, 11" x 14" (min.) – (20 copies must be submitted).
- b. show name of owner, legal description and Assessor's Parcel Number.
- c. show existing property dimensions, size, adjacent roads, canals, right-of-ways, easements, etc.
- d. show all existing and proposed structures (both above and below ground) location of sewer and water systems.
- e. show adjacent property uses and approximate distances to nearest structures.
- f. indicate name of person preparing site plan.
- g. show North orientation.
- h. show sufficient dimensions and information for proper evaluation to be done.

**CAUTION:** Incomplete or inaccurate applications, plans will cause the entire application to be rejected.

S:/forms\_lists/8.5 x 11 APPS/variance backside 8.5 x 11